

# BFR740EL3

## SiGe:C NPN RF bipolar transistor



Order now



Technical documents



Simulation



Support

## Product description

The BFR740EL3 is a wideband RF heterojunction bipolar transistor (HBT) available in a low profile package.



## Feature list

- Low noise figure  $NF_{\min} = 0.5$  dB at 1.9 GHz 3 V, 6 mA; 0.8 dB at 5.5 GHz, 3 V, 6 mA
- High power gain  $G_{ms} = 20$  dB at 5.5 GHz, 3 V, 15 mA
- Low profile and small form factor leadless package
- High sensitivity low noise laser receiver matrix
- High RF transistor  $h_{FE}$  controllability

## Product validation

Qualified for industrial applications according to the relevant tests of JEDEC47/20/22.

## Potential applications

- Wireless communications: WLAN 2.4 GHz and 5-6 GHz bands, WiMax and UWB
- Satellite communication systems: GNSS navigation systems (GPS, GLONASS, BeiDou, Galileo), satellite radio (SDARs, DAB) and C-band LNB
- Multimedia applications such as portable TV, CATV and FM radio
- ISM applications like RKE, AMR and Zigbee, as well as for emerging wireless applications
- Lidar based systems

## Device information

**Table 1** Part information

Product name / Ordering code	Package	Pin configuration			Marking	Pieces / Reel
BFR740EL3 / BFR740EL3E6829XTSA1	TSLP-3-10	1 = B	2 = C	3 = E	R2	15000

**Attention:** ESD (Electrostatic discharge) sensitive device, observe handling precautions

## Table of contents

	<b>Product description</b> .....	1
	<b>Feature list</b> .....	1
	<b>Product validation</b> .....	1
	<b>Potential applications</b> .....	1
	<b>Device information</b> .....	1
	<b>Table of contents</b> .....	2
<b>1</b>	<b>Absolute maximum ratings</b> .....	3
<b>2</b>	<b>Thermal characteristics</b> .....	4
<b>3</b>	<b>Electrical characteristics</b> .....	5
3.1	DC characteristics .....	5
3.2	General AC characteristics .....	5
3.3	Frequency dependent AC characteristics .....	6
3.4	Characteristic DC diagrams .....	10
3.5	Characteristic AC diagrams .....	13
<b>4</b>	<b>Package information TSLP-3-10</b> .....	20
	<b>Revision history</b> .....	21
	<b>Disclaimer</b> .....	22

**Absolute maximum ratings**

**1 Absolute maximum ratings**

**Table 2 Absolute maximum ratings at  $T_A = 25\text{ °C}$  (unless otherwise specified)**

Parameter	Symbol	Values		Unit	Note or test condition
		Min.	Max.		
Collector emitter voltage	$V_{CEO}$	-	4.0	V	Open base
			3.5		$T_A = -55\text{ °C}$ , open base
Collector emitter voltage	$V_{CES}$		13		E-B short circuited
Collector base voltage	$V_{CBO}$		13		Open emitter
Emitter base voltage	$V_{EBO}$		1.2		Open collector
Base current	$I_B$		4	mA	-
Collector current	$I_C$		40		
Total power dissipation <sup>1)</sup>	$P_{tot}$		160	mW	$T_S \leq 105\text{ °C}$
Junction temperature	$T_J$		150	°C	-
Storage temperature	$T_{Stg}$	-55			

**Attention:** *Stresses above the max. values listed here may cause permanent damage to the device. Exposure to absolute maximum rating conditions for extended periods may affect device reliability. Exceeding only one of these values may cause irreversible damage to the integrated circuit.*

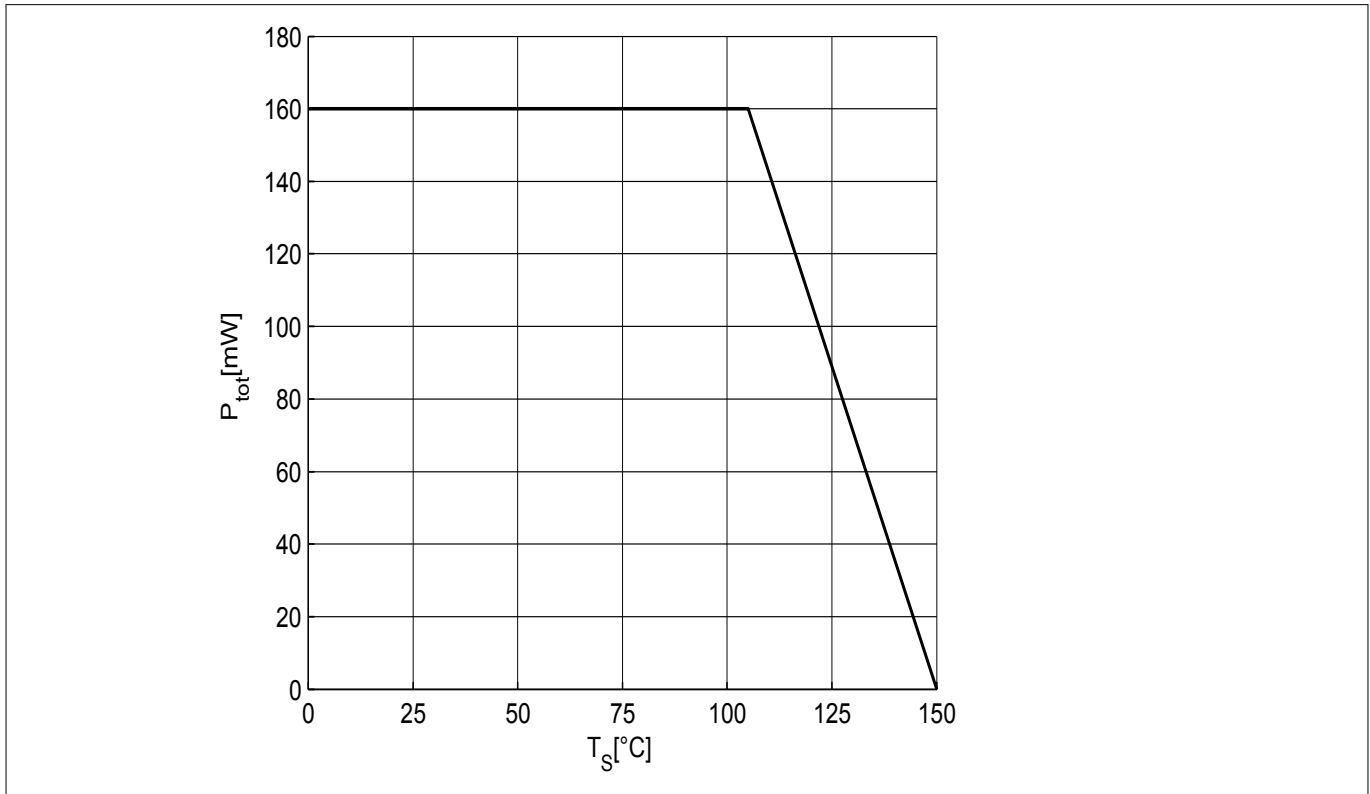
<sup>1</sup>  $T_S$  is the soldering point temperature.  $T_S$  is measured on the emitter lead at the soldering point of the PCB.

Thermal characteristics

## 2 Thermal characteristics

**Table 3 Thermal resistance**

Parameter	Symbol	Values			Unit	Note or test condition
		Min.	Typ.	Max.		
Junction - soldering point	$R_{thJS}$	-	280	-	K/W	



**Figure 1 Total power dissipation  $P_{tot} = f(T_S)$**

**Electrical characteristics**

**3 Electrical characteristics**

**3.1 DC characteristics**

**Table 4** DC characteristics at  $T_A = 25\text{ °C}$

Parameter	Symbol	Values			Unit	Note or test condition
		Min.	Typ.	Max.		
Collector emitter breakdown voltage	$V_{(BR)CEO}$	4	4.7	–	V	$I_C = 1\text{ mA}$ , $I_B = 0$ , open base
Collector emitter leakage current	$I_{CES}$	–	1 1	400 <sup>1)</sup> 40 <sup>1)</sup>	nA	$V_{CE} = 13\text{ V}$ , $V_{BE} = 0$ $V_{CE} = 5\text{ V}$ , $V_{BE} = 0$ E-B short circuited
Collector base leakage current	$I_{CBO}$		1	40 <sup>1)</sup>		$V_{CB} = 5\text{ V}$ , $I_E = 0$ , open emitter
Emitter base leakage current	$I_{EBO}$		1	40 <sup>1)</sup>		$V_{EB} = 0.5\text{ V}$ , $I_C = 0$ , open collector
DC current gain	$h_{FE}$	160	210	250		$V_{CE} = 3\text{ V}$ , $I_C = 25\text{ mA}$ , pulse measured

**3.2 General AC characteristics**

**Table 5** General AC characteristics at  $T_A = 25\text{ °C}$

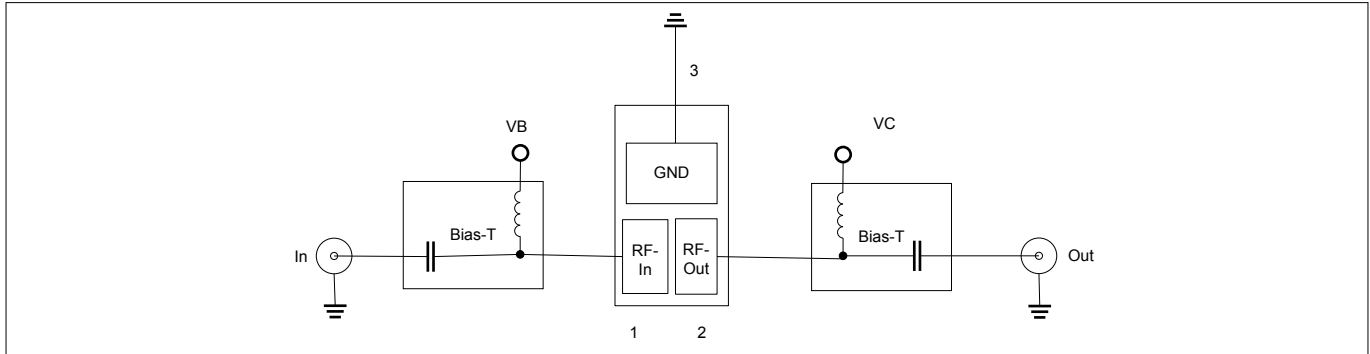
Parameter	Symbol	Values			Unit	Note or test condition
		Min.	Typ.	Max.		
Transition frequency	$f_T$	–	42	–	GHz	$V_{CE} = 3\text{ V}$ , $I_C = 25\text{ mA}$ , $f = 2\text{ GHz}$
Collector base capacitance	$C_{CB}$		0.09	0.12	pF	$V_{CB} = 3\text{ V}$ , $V_{BE} = 0$ , $f = 1\text{ MHz}$ , emitter grounded
Collector emitter capacitance	$C_{CE}$		0.3	–		$V_{CE} = 3\text{ V}$ , $V_{BE} = 0$ , $f = 1\text{ MHz}$ , base grounded
Emitter base capacitance	$C_{EB}$		0.4			$V_{EB} = 0.5\text{ V}$ , $V_{CB} = 0$ , $f = 1\text{ MHz}$ , collector grounded

<sup>1</sup> Maximum values not limited by the device but by the short cycle time of the 100% test.

**Electrical characteristics**

**3.3 Frequency dependent AC characteristics**

Measurement setup is a test fixture with Bias-T's in a 50 Ω system,  $T_A = 25\text{ °C}$ .



**Figure 2** Testing circuit

**Table 6** AC characteristics,  $V_{CE} = 3\text{ V}$ ,  $f = 150\text{ MHz}$

Parameter	Symbol	Values			Unit	Note or test condition
		Min.	Typ.	Max.		
Power gain		-		-	dB	$I_C = 15\text{ mA}$
<ul style="list-style-type: none"> <li>Maximum power gain</li> <li>Transducer gain</li> </ul>	$G_{ms}$ $ S_{21} ^2$		35 29.5			
Noise figure						$I_C = 6\text{ mA}$
<ul style="list-style-type: none"> <li>Minimum noise figure</li> <li>Associated gain</li> </ul>	$NF_{min}$ $G_{ass}$	0.45 27.5				
Linearity					dBm	$Z_S = Z_L = 50\text{ }\Omega$ , $I_C = 15\text{ mA}$
<ul style="list-style-type: none"> <li>3rd order intercept point at output</li> <li>1 dB gain compression point at output</li> </ul>	$OIP_3$ $OP_{1dB}$	21 3.5				

**Table 7** AC characteristics,  $V_{CE} = 3\text{ V}$ ,  $f = 450\text{ MHz}$

Parameter	Symbol	Values			Unit	Note or test condition
		Min.	Typ.	Max.		
Power gain		-		-	dB	$I_C = 15\text{ mA}$
<ul style="list-style-type: none"> <li>Maximum power gain</li> <li>Transducer gain</li> </ul>	$G_{ms}$ $ S_{21} ^2$		31 29			
Noise figure						$I_C = 6\text{ mA}$
<ul style="list-style-type: none"> <li>Minimum noise figure</li> <li>Associated gain</li> </ul>	$NF_{min}$ $G_{ass}$	0.45 26.5				
Linearity					dBm	$Z_S = Z_L = 50\text{ }\Omega$ , $I_C = 15\text{ mA}$
<ul style="list-style-type: none"> <li>3rd order intercept point at output</li> <li>1 dB gain compression point at output</li> </ul>	$OIP_3$ $OP_{1dB}$	21 7				

**Electrical characteristics**

**Table 8 AC characteristics,  $V_{CE} = 3\text{ V}$ ,  $f = 900\text{ MHz}$**

Parameter	Symbol	Values			Unit	Note or test condition
		Min.	Typ.	Max.		
Power gain	$G_{ms}$ $ S_{21} ^2$	-	28	-	dB	$I_C = 15\text{ mA}$
<ul style="list-style-type: none"> <li>Maximum power gain</li> <li>Transducer gain</li> </ul>			27			
Noise figure	$NF_{min}$ $G_{ass}$		0.45			$I_C = 6\text{ mA}$
<ul style="list-style-type: none"> <li>Minimum noise figure</li> <li>Associated gain</li> </ul>			25			
Linearity	$OIP_3$ $OP_{1dB}$		22.5		dBm	$Z_S = Z_L = 50\ \Omega$ , $I_C = 15\text{ mA}$
<ul style="list-style-type: none"> <li>3rd order intercept point at output</li> <li>1 dB gain compression point at output</li> </ul>			8			

**Table 9 AC characteristics,  $V_{CE} = 3\text{ V}$ ,  $f = 1.5\text{ GHz}$**

Parameter	Symbol	Values			Unit	Note or test condition
		Min.	Typ.	Max.		
Power gain	$G_{ms}$ $ S_{21} ^2$	-	25.5	-	dB	$I_C = 15\text{ mA}$
<ul style="list-style-type: none"> <li>Maximum power gain</li> <li>Transducer gain</li> </ul>			25			
Noise figure	$NF_{min}$ $G_{ass}$		0.5			$I_C = 6\text{ mA}$
<ul style="list-style-type: none"> <li>Minimum noise figure</li> <li>Associated gain</li> </ul>			22.5			
Linearity	$OIP_3$ $OP_{1dB}$		23		dBm	$Z_S = Z_L = 50\ \Omega$ , $I_C = 15\text{ mA}$
<ul style="list-style-type: none"> <li>3rd order intercept point at output</li> <li>1 dB gain compression point at output</li> </ul>			8			

**Table 10 AC characteristics,  $V_{CE} = 3\text{ V}$ ,  $f = 1.9\text{ GHz}$**

Parameter	Symbol	Values			Unit	Note or test condition
		Min.	Typ.	Max.		
Power gain	$G_{ms}$ $ S_{21} ^2$	-	24.5	-	dB	$I_C = 15\text{ mA}$
<ul style="list-style-type: none"> <li>Maximum power gain</li> <li>Transducer gain</li> </ul>			23.5			
Noise figure	$NF_{min}$ $G_{ass}$		0.5			$I_C = 6\text{ mA}$
<ul style="list-style-type: none"> <li>Minimum noise figure</li> <li>Associated gain</li> </ul>			21			
Linearity	$OIP_3$ $OP_{1dB}$		23		dBm	$Z_S = Z_L = 50\ \Omega$ , $I_C = 15\text{ mA}$
<ul style="list-style-type: none"> <li>3rd order intercept point at output</li> <li>1 dB gain compression point at output</li> </ul>			8			

**Electrical characteristics**

**Table 11 AC characteristics,  $V_{CE} = 3\text{ V}$ ,  $f = 2.4\text{ GHz}$**

Parameter	Symbol	Values			Unit	Note or test condition
		Min.	Typ.	Max.		
Power gain	$G_{ms}$ $ S_{21} ^2$	-	23.5	-	dB	$I_C = 15\text{ mA}$
<ul style="list-style-type: none"> <li>Maximum power gain</li> <li>Transducer gain</li> </ul>			21.5			
Noise figure	$NF_{min}$ $G_{ass}$		0.5			$I_C = 6\text{ mA}$
<ul style="list-style-type: none"> <li>Minimum noise figure</li> <li>Associated gain</li> </ul>			19.5			
Linearity	$OIP_3$ $OP_{1dB}$		23		dBm	$Z_S = Z_L = 50\ \Omega$ , $I_C = 15\text{ mA}$
<ul style="list-style-type: none"> <li>3rd order intercept point at output</li> <li>1 dB gain compression point at output</li> </ul>			8			

**Table 12 AC characteristics,  $V_{CE} = 3\text{ V}$ ,  $f = 3.5\text{ GHz}$**

Parameter	Symbol	Values			Unit	Note or test condition
		Min.	Typ.	Max.		
Power gain	$G_{ms}$ $ S_{21} ^2$	-	22	-	dB	$I_C = 15\text{ mA}$
<ul style="list-style-type: none"> <li>Maximum power gain</li> <li>Transducer gain</li> </ul>			18.5			
Noise figure	$NF_{min}$ $G_{ass}$		0.6			$I_C = 6\text{ mA}$
<ul style="list-style-type: none"> <li>Minimum noise figure</li> <li>Associated gain</li> </ul>			16.5			
Linearity	$OIP_3$ $OP_{1dB}$		24.5		dBm	$Z_S = Z_L = 50\ \Omega$ , $I_C = 15\text{ mA}$
<ul style="list-style-type: none"> <li>3rd order intercept point at output</li> <li>1 dB gain compression point at output</li> </ul>			9			

**Table 13 AC characteristics,  $V_{CE} = 3\text{ V}$ ,  $f = 5.5\text{ GHz}$**

Parameter	Symbol	Values			Unit	Note or test condition
		Min.	Typ.	Max.		
Power gain	$G_{ms}$ $ S_{21} ^2$	-	20	-	dB	$I_C = 15\text{ mA}$
<ul style="list-style-type: none"> <li>Maximum power gain</li> <li>Transducer gain</li> </ul>			14.5			
Noise figure	$NF_{min}$ $G_{ass}$		0.8			$I_C = 6\text{ mA}$
<ul style="list-style-type: none"> <li>Minimum noise figure</li> <li>Associated gain</li> </ul>			13			
Linearity	$OIP_3$ $OP_{1dB}$		25		dBm	$Z_S = Z_L = 50\ \Omega$ , $I_C = 15\text{ mA}$
<ul style="list-style-type: none"> <li>3rd order intercept point at output</li> <li>1 dB gain compression point at output</li> </ul>			9.5			



**Electrical characteristics**

**Table 14 AC characteristics,  $V_{CE} = 3\text{ V}$ ,  $f = 10\text{ GHz}$**

Parameter	Symbol	Values			Unit	Note or test condition
		Min.	Typ.	Max.		
Power gain	$G_{ma}$ $ S_{21} ^2$	-	13	-	dB	$I_C = 15\text{ mA}$
<ul style="list-style-type: none"> <li>Maximum power gain</li> <li>Transducer gain</li> </ul>			9			
Noise figure	$NF_{min}$ $G_{ass}$		1.3			$I_C = 6\text{ mA}$
<ul style="list-style-type: none"> <li>Minimum noise figure</li> <li>Associated gain</li> </ul>			8.5			
Linearity	$OIP_3$ $OP_{1dB}$		24		dBm	$Z_S = Z_L = 50\ \Omega$ , $I_C = 15\text{ mA}$
<ul style="list-style-type: none"> <li>3rd order intercept point at output</li> <li>1 dB gain compression point at output</li> </ul>			9			

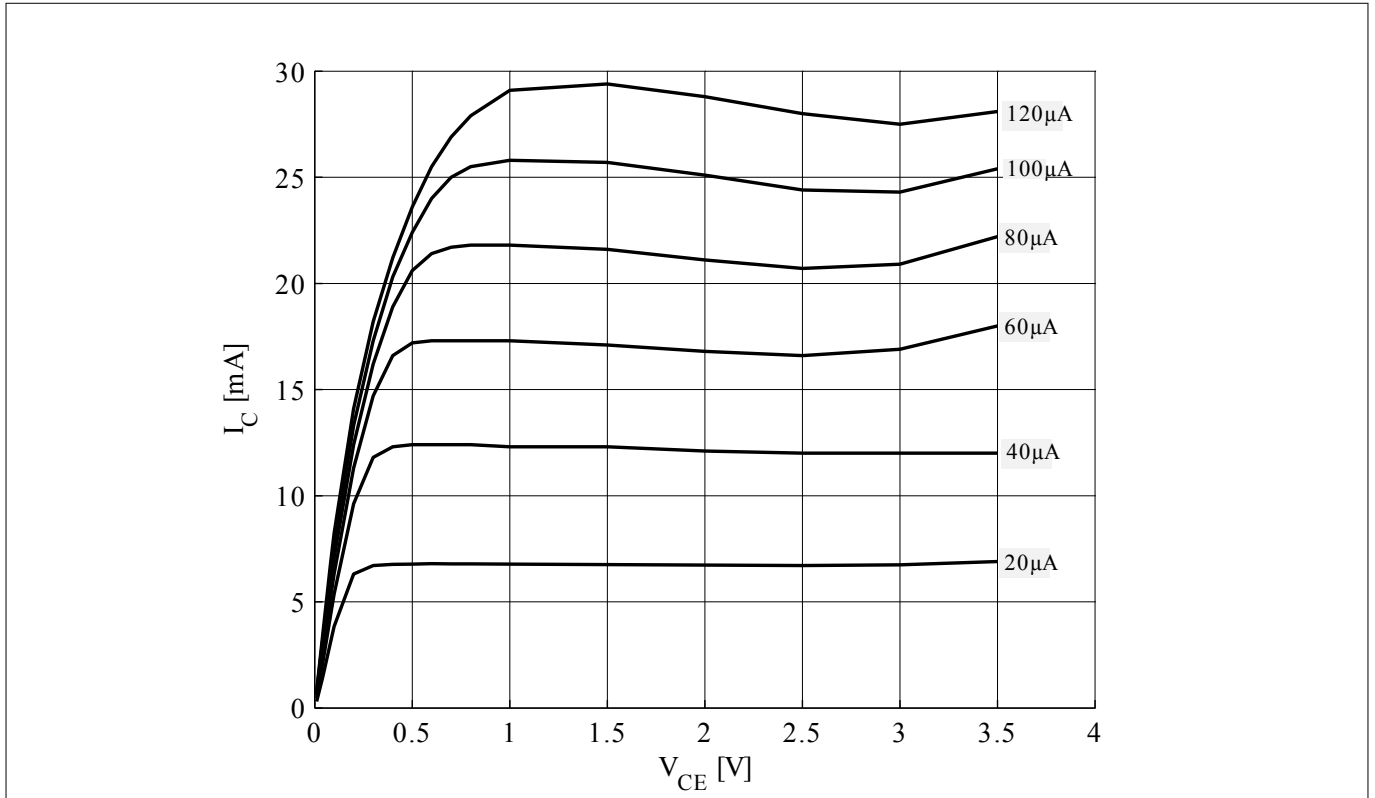
**Table 15 AC characteristics,  $V_{CE} = 3\text{ V}$ ,  $f = 12\text{ GHz}$**

Parameter	Symbol	Values			Unit	Note or test condition
		Min.	Typ.	Max.		
Power gain	$G_{ma}$ $ S_{21} ^2$	-	11	-	dB	$I_C = 15\text{ mA}$
<ul style="list-style-type: none"> <li>Maximum power gain</li> <li>Transducer gain</li> </ul>			7			
Noise figure	$NF_{min}$ $G_{ass}$		1.5			$I_C = 6\text{ mA}$
<ul style="list-style-type: none"> <li>Minimum noise figure</li> <li>Associated gain</li> </ul>			7.5			
Linearity	$OIP_3$ $OP_{1dB}$		20.5		dBm	$Z_S = Z_L = 50\ \Omega$ , $I_C = 15\text{ mA}$
<ul style="list-style-type: none"> <li>3rd order intercept point at output</li> <li>1 dB gain compression point at output</li> </ul>			6.5			

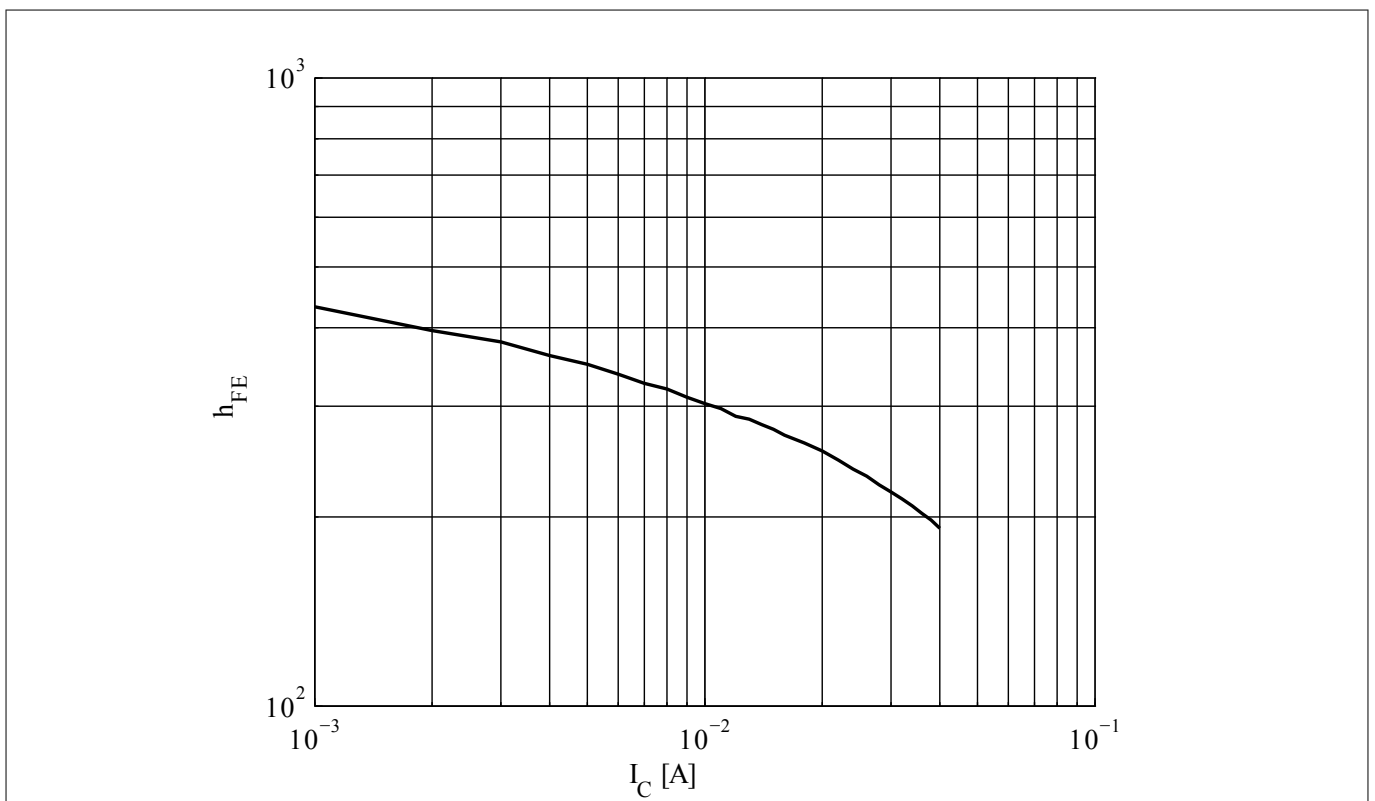
Note:  $G_{ms} = |S_{21} / S_{12}|$  for  $k < 1$ ;  $G_{ma} = |S_{21} / S_{12}|(k - (k^2 - 1)^{1/2})$  for  $k > 1$ . In order to get the  $NF_{min}$  values stated in this chapter, the test fixture losses have been subtracted from all measured results.  $OIP_3$  value depends on termination of all intermodulation frequency components. Termination used for this measurement is  $50\ \Omega$  from 0.2 MHz to 12 GHz.

**Electrical characteristics**

**3.4 Characteristic DC diagrams**

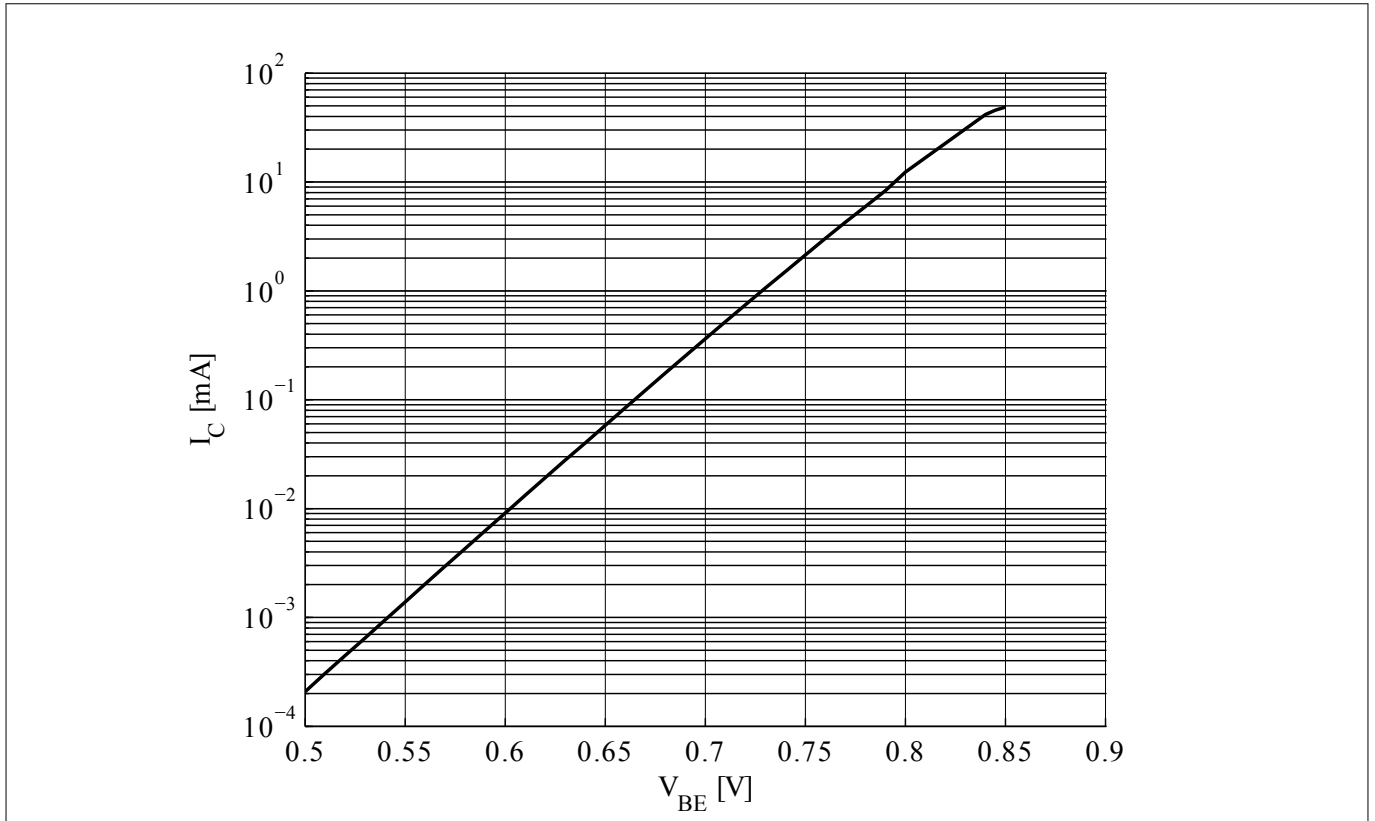


**Figure 3 Collector current vs. collector emitter voltage  $I_C = f(V_{CE})$ ,  $I_B = \text{parameter}$**

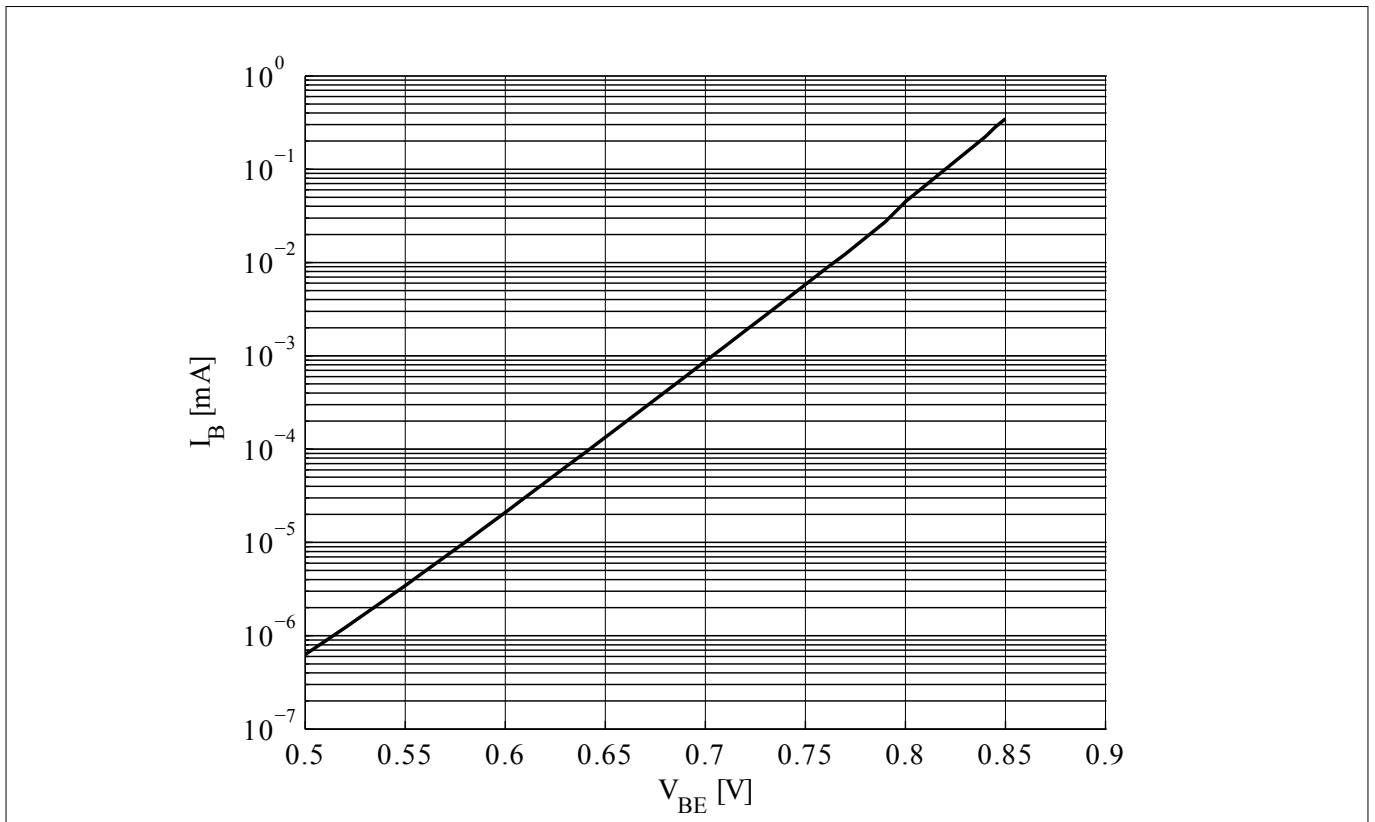


**Figure 4 DC current gain  $h_{FE} = f(I_C)$ ,  $V_{CE} = 3 V$**

**Electrical characteristics**

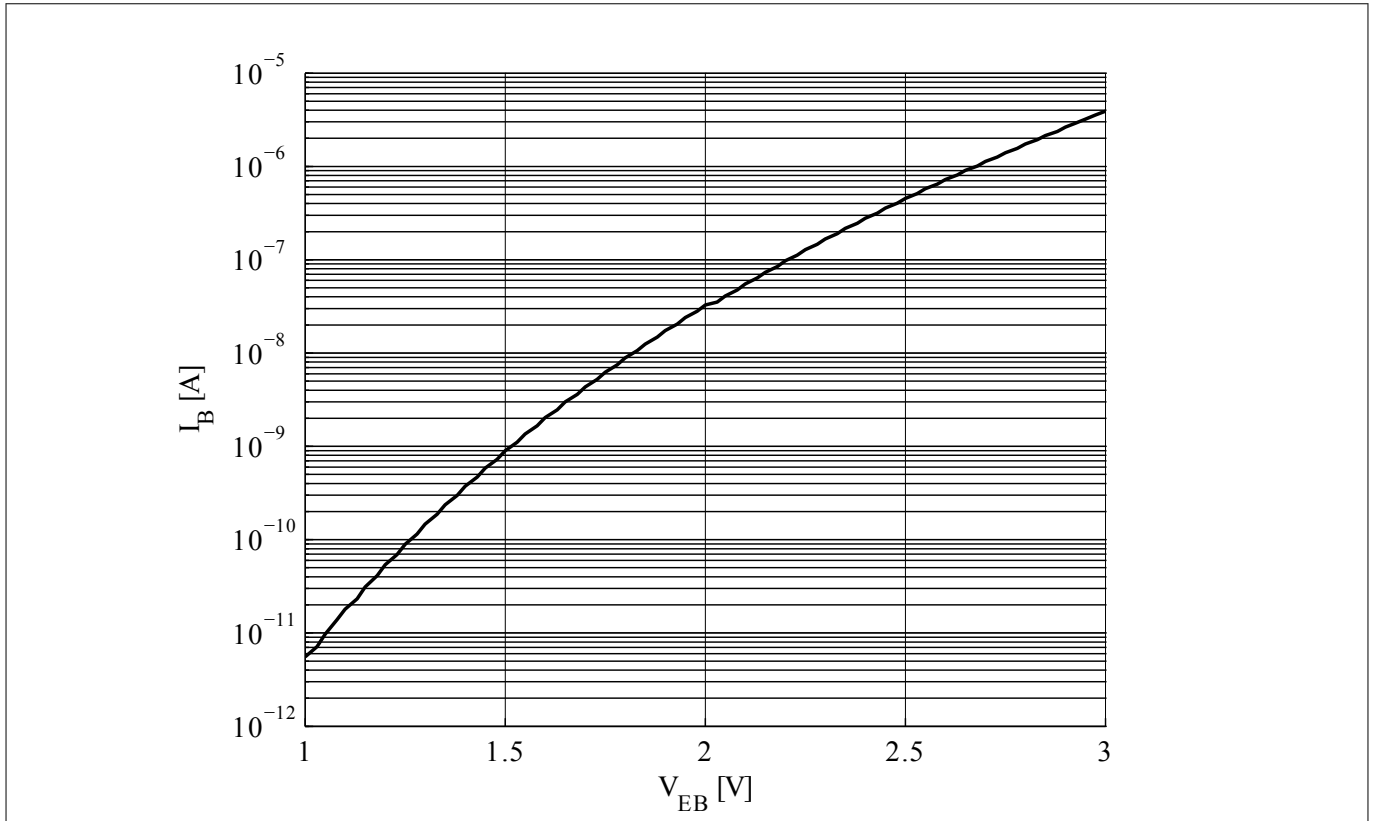


**Figure 5** Collector current vs. base emitter forward voltage  $I_C = f(V_{BE}), V_{CE} = 2 \text{ V}$



**Figure 6** Base current vs. base emitter forward voltage  $I_B = f(V_{BE}), V_{CE} = 2 \text{ V}$

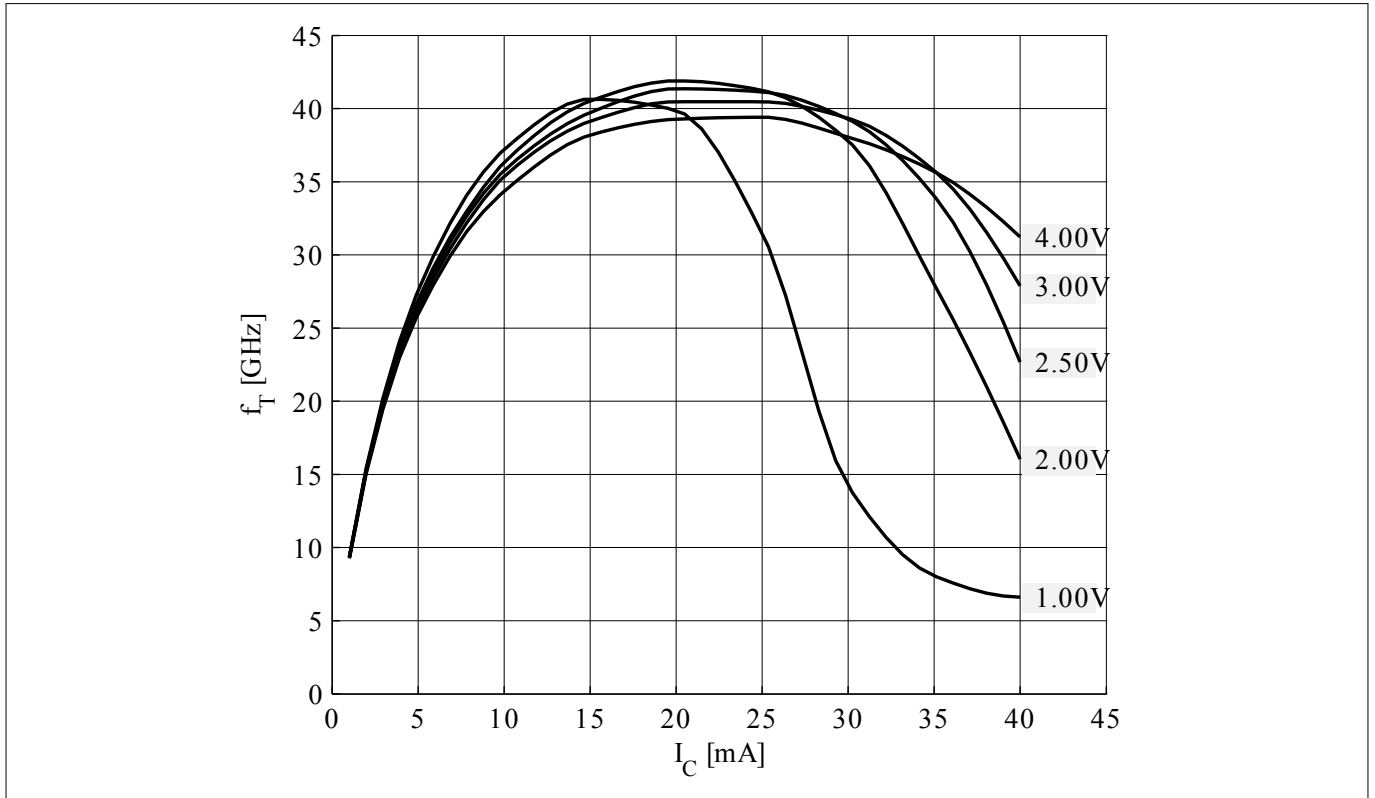
**Electrical characteristics**



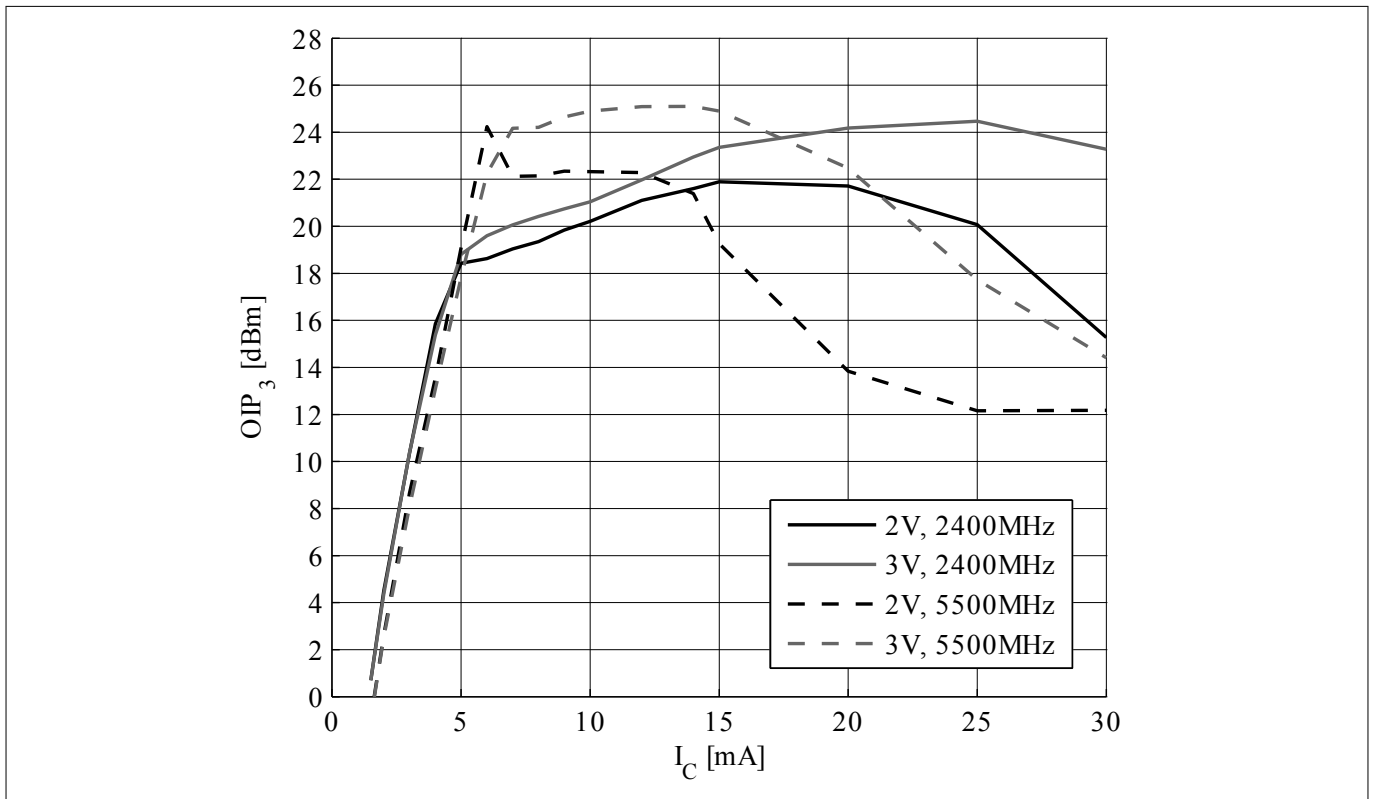
**Figure 7** Base current vs. base emitter reverse voltage  $I_B = f(V_{EB}), V_{CE} = 2\text{ V}$

Electrical characteristics

**3.5 Characteristic AC diagrams**

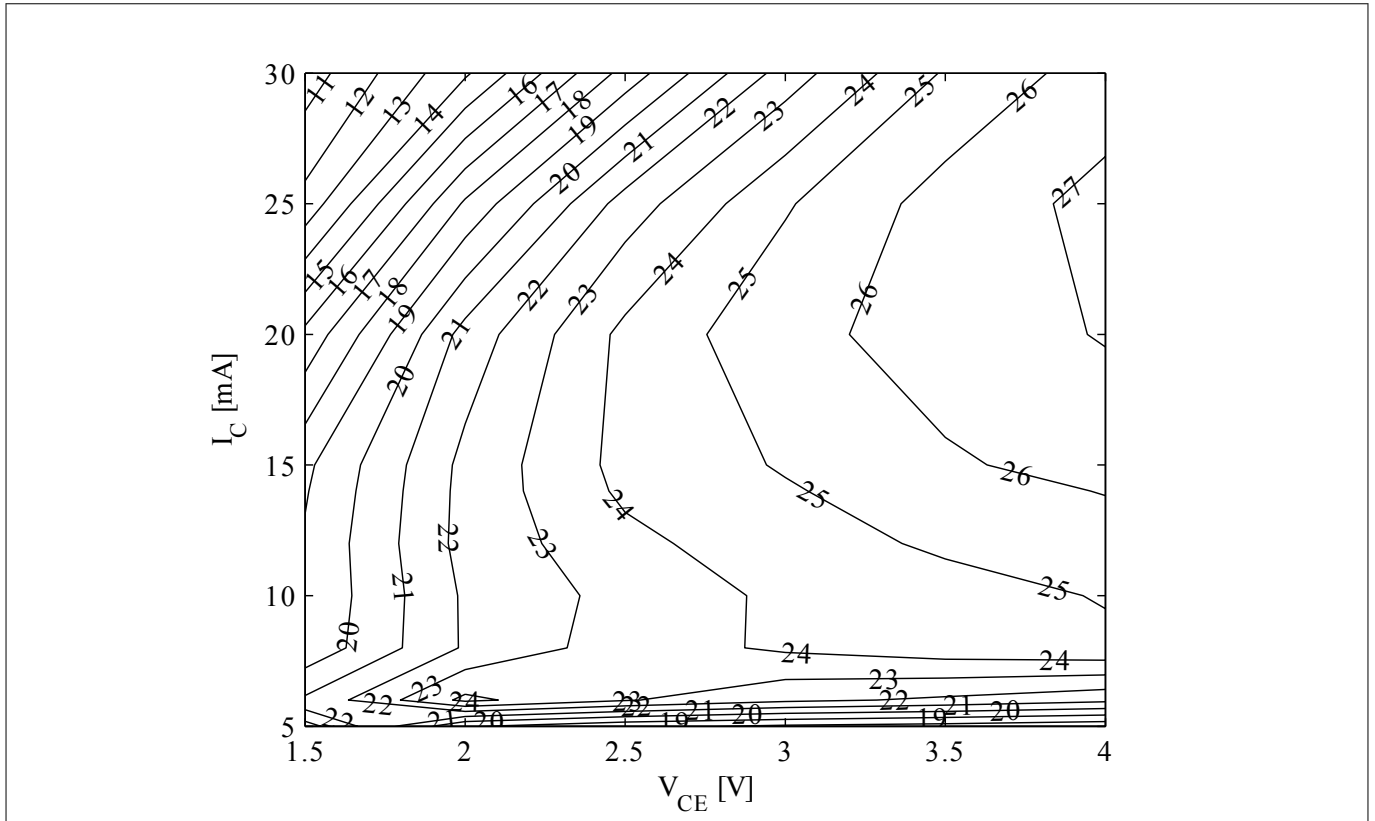


**Figure 8** Transition frequency  $f_T = f(I_C)$ ,  $f = 2$  GHz,  $V_{CE} = \text{parameter}$

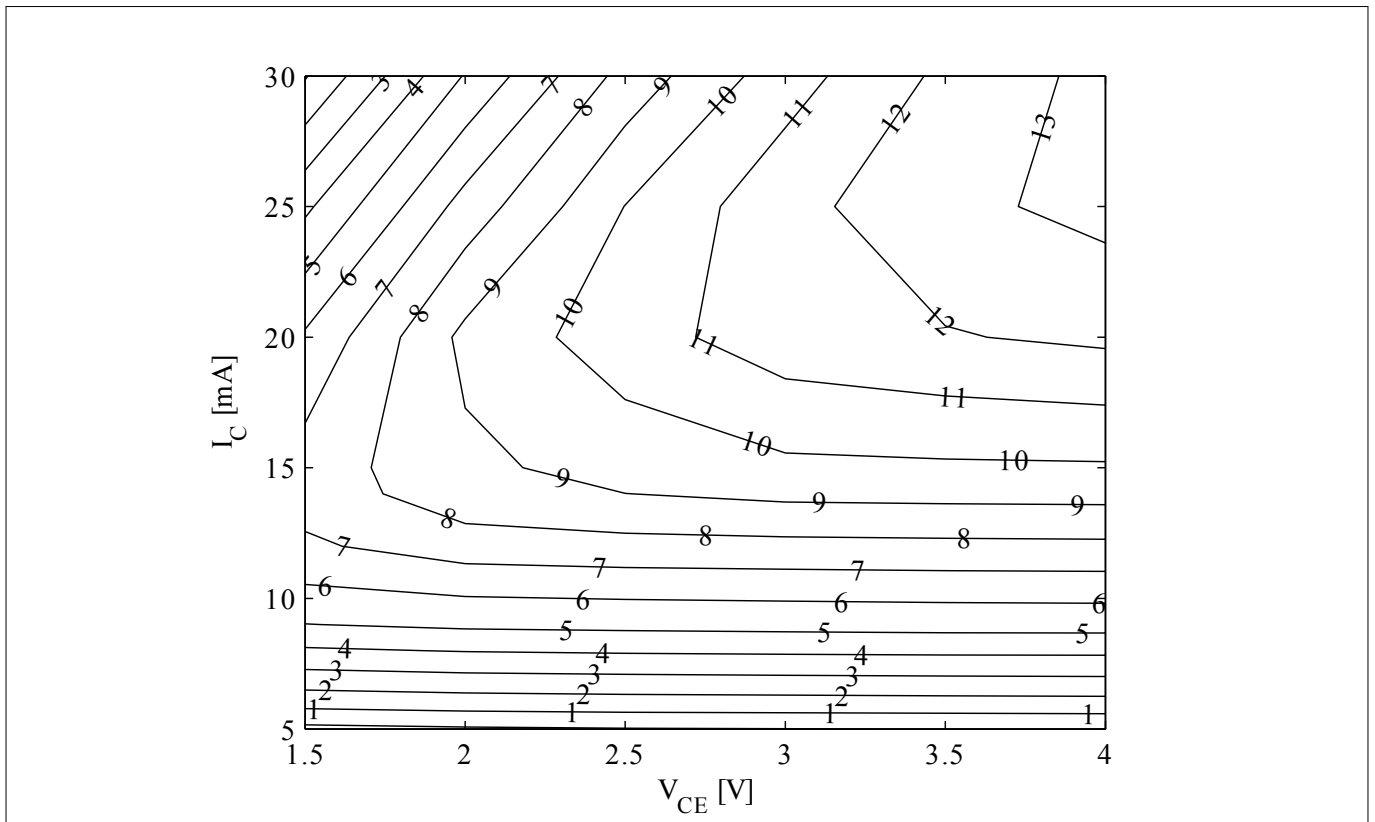


**Figure 9** 3rd order intercept point at output  $OIP_3 = f(I_C)$ ,  $Z_S = Z_L = 50 \Omega$ ,  $V_{CE}$ ,  $f = \text{parameter}$

**Electrical characteristics**

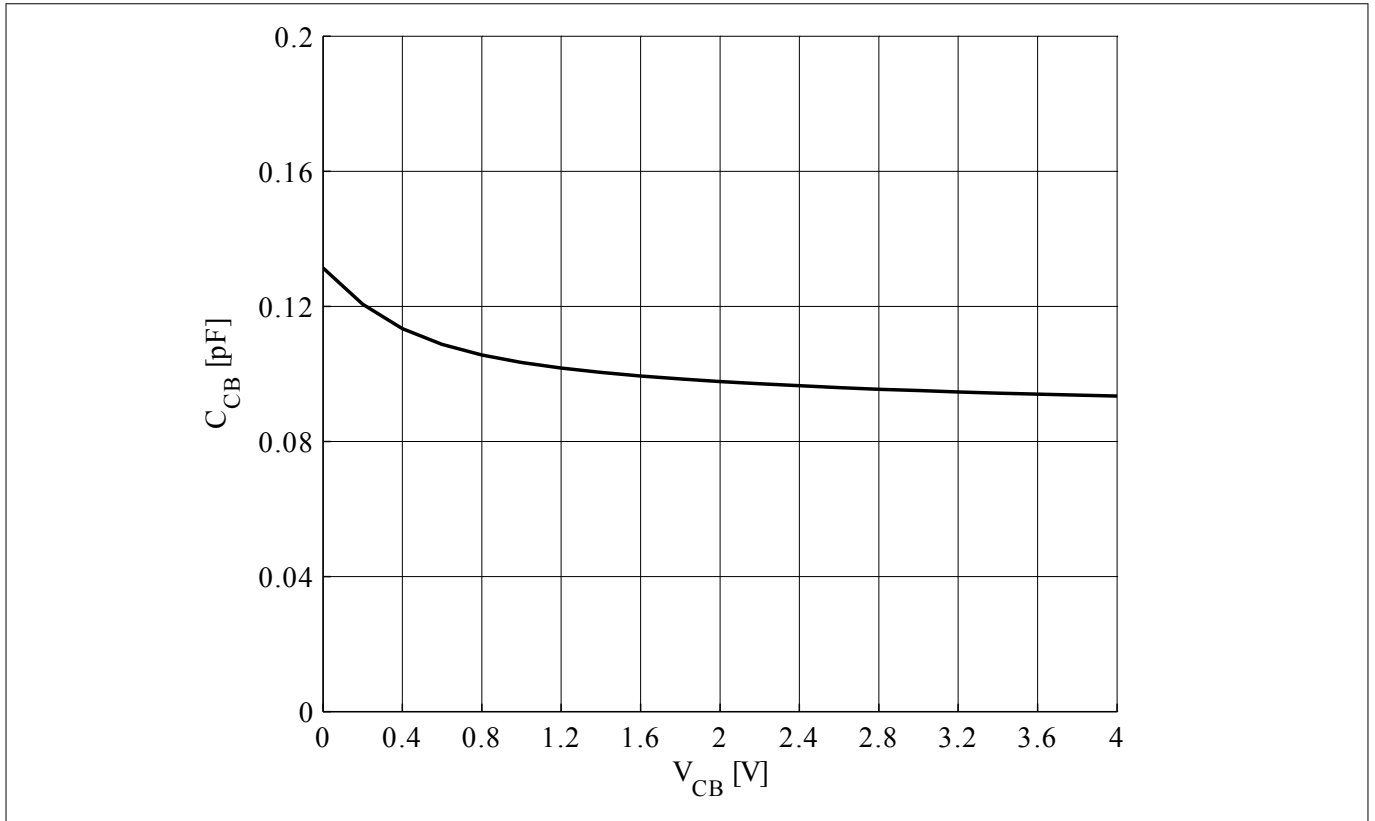


**Figure 10** 3rd order intercept point at output  $OIP_3$  [dBm] =  $f(I_C, V_{CE})$ ,  $Z_S = Z_L = 50 \Omega$ ,  $f = 5.5$  GHz

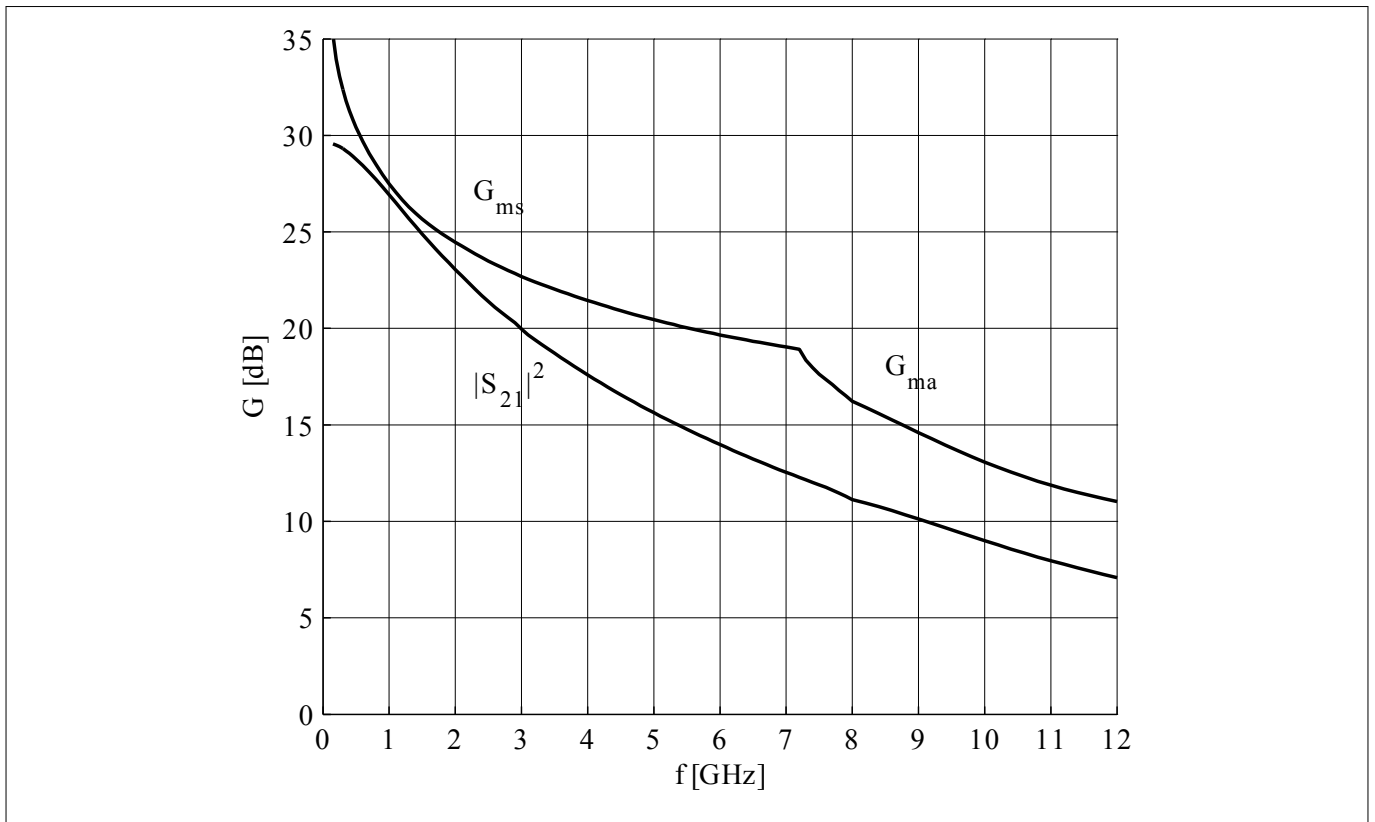


**Figure 11** Compression point at output  $OP_{1dB}$  [dBm] =  $f(I_C, V_{CE})$ ,  $Z_S = Z_L = 50 \Omega$ ,  $f = 5.5$  GHz

**Electrical characteristics**

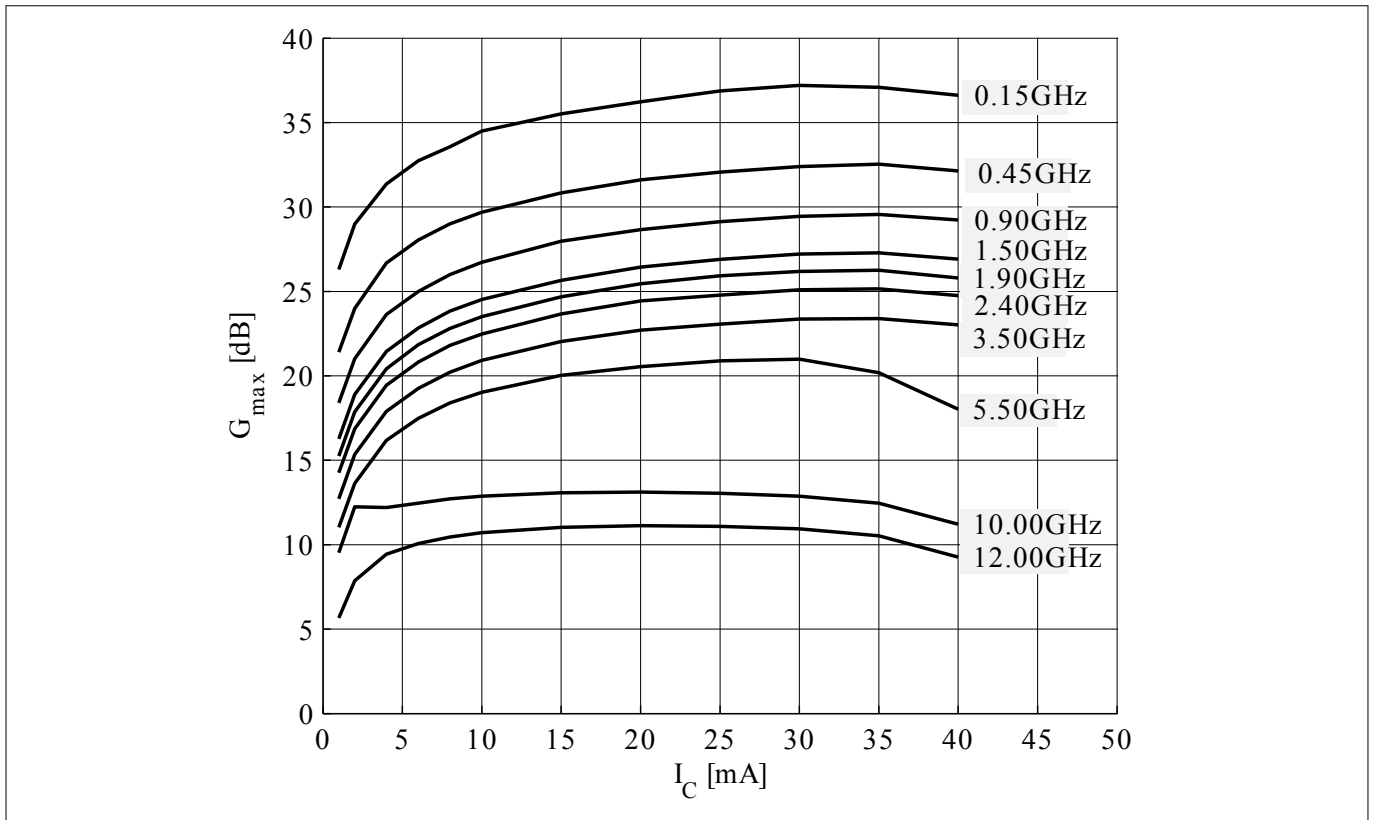


**Figure 12** Collector base capacitance  $C_{CB} = f(V_{CB})$ ,  $f = 1$  MHz

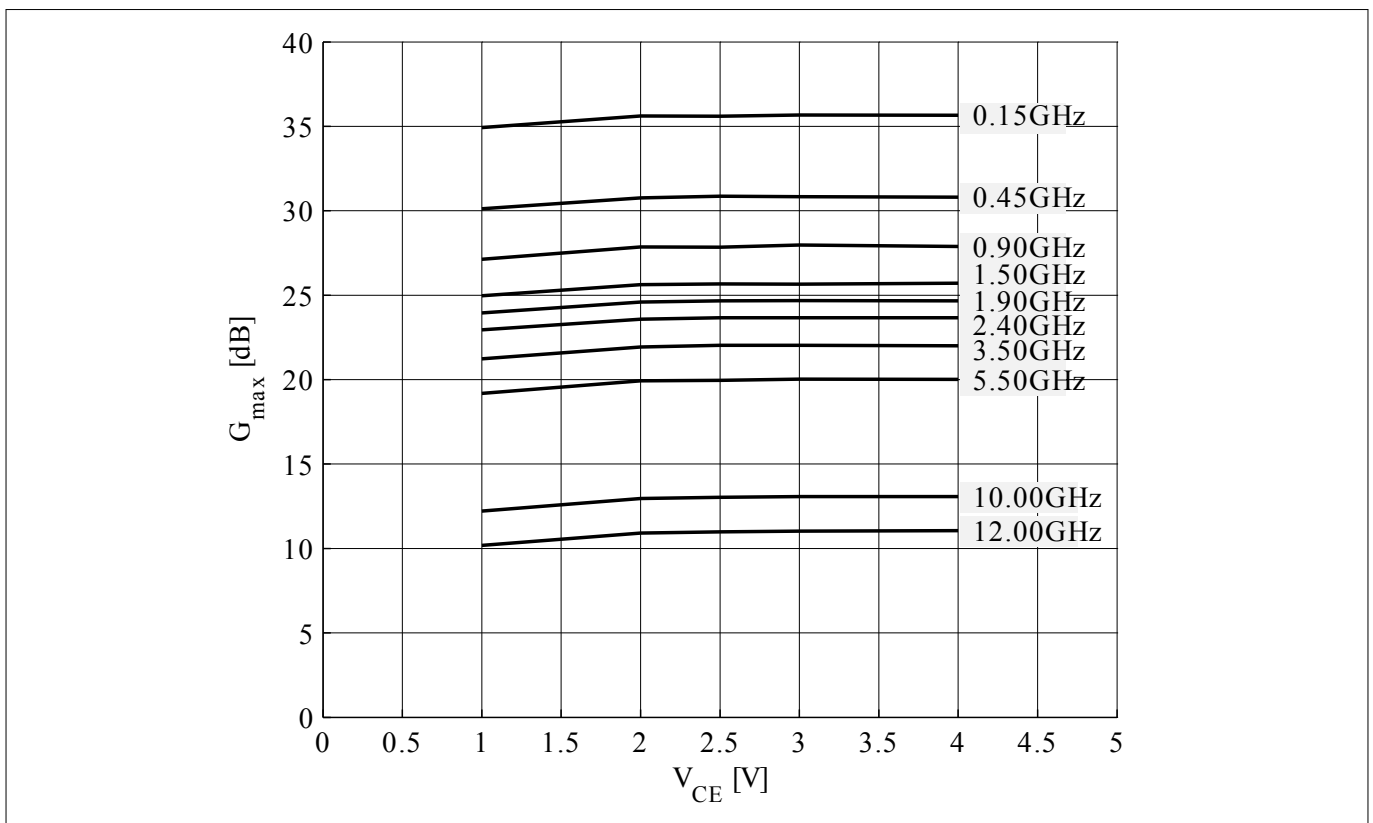


**Figure 13** Gain  $G_{ma}$ ,  $G_{ms}$ ,  $|S_{21}|^2 = f(f)$ ,  $V_{CE} = 3$  V,  $I_C = 15$  mA

**Electrical characteristics**



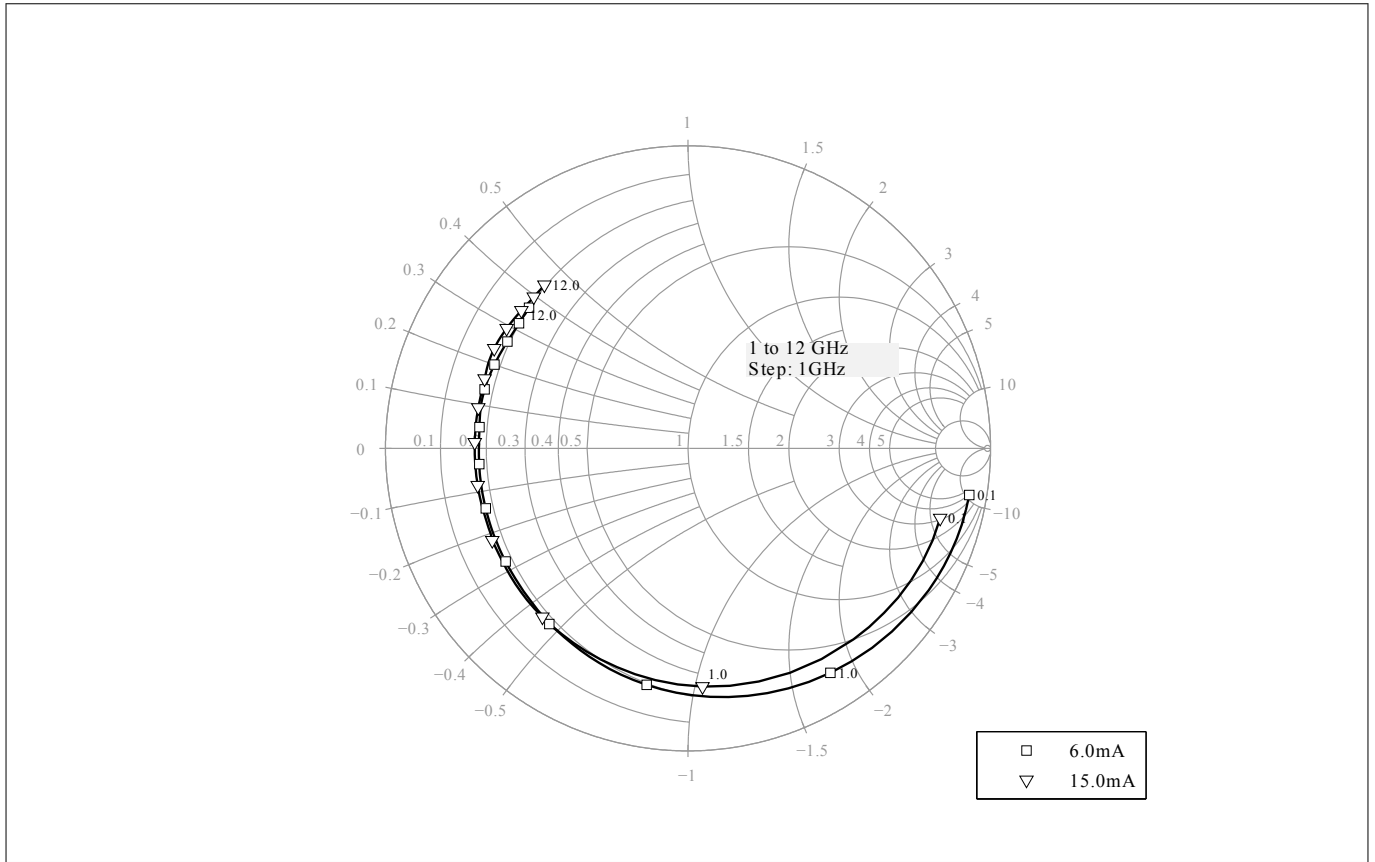
**Figure 14** Maximum power gain  $G_{max} = f(I_C)$ ,  $V_{CE} = 3\text{ V}$ ,  $f = \text{parameter}$



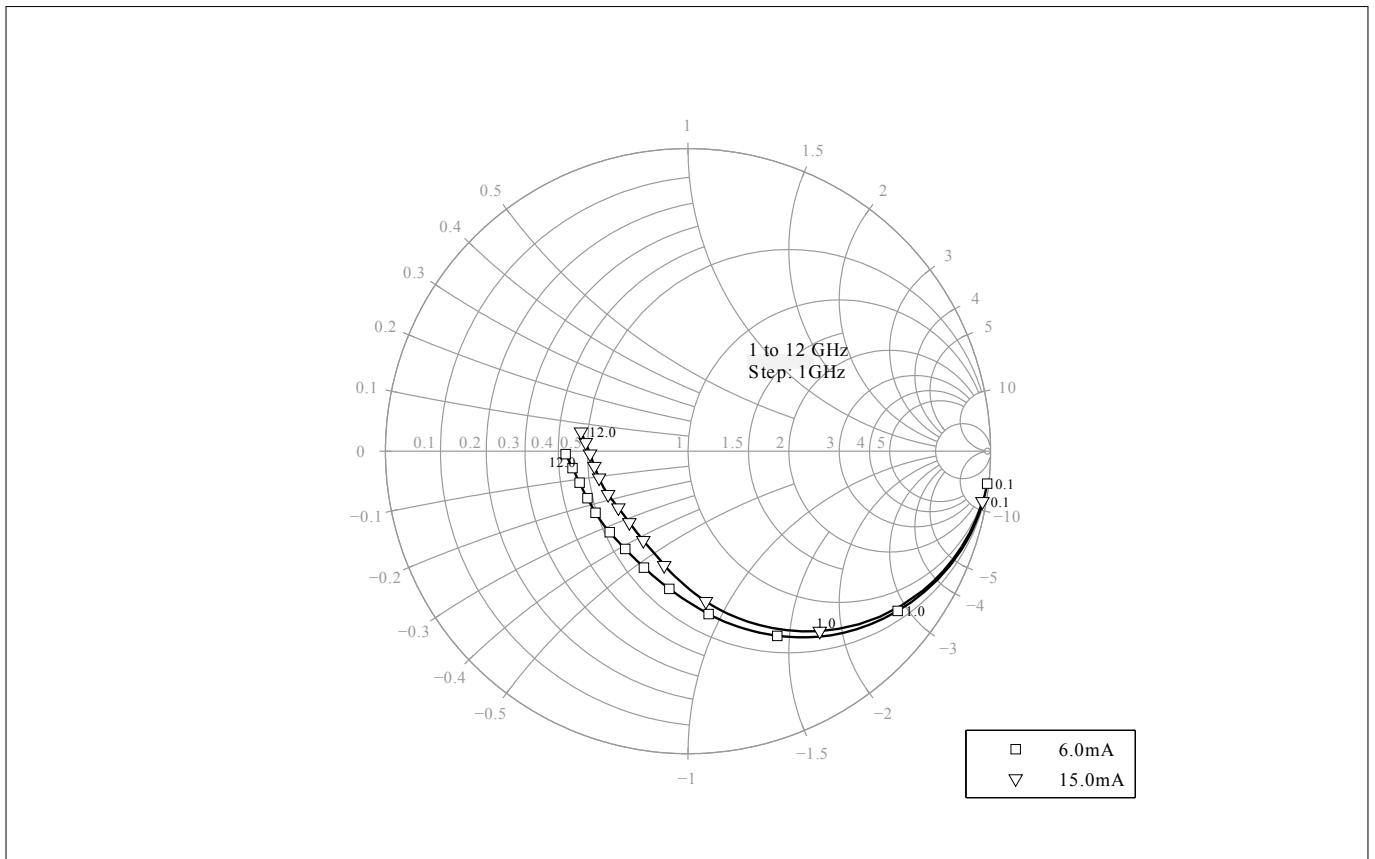
**Figure 15** Maximum power gain  $G_{max} = f(V_{CE})$ ,  $I_C = 15\text{ mA}$ ,  $f = \text{parameter}$



**Electrical characteristics**

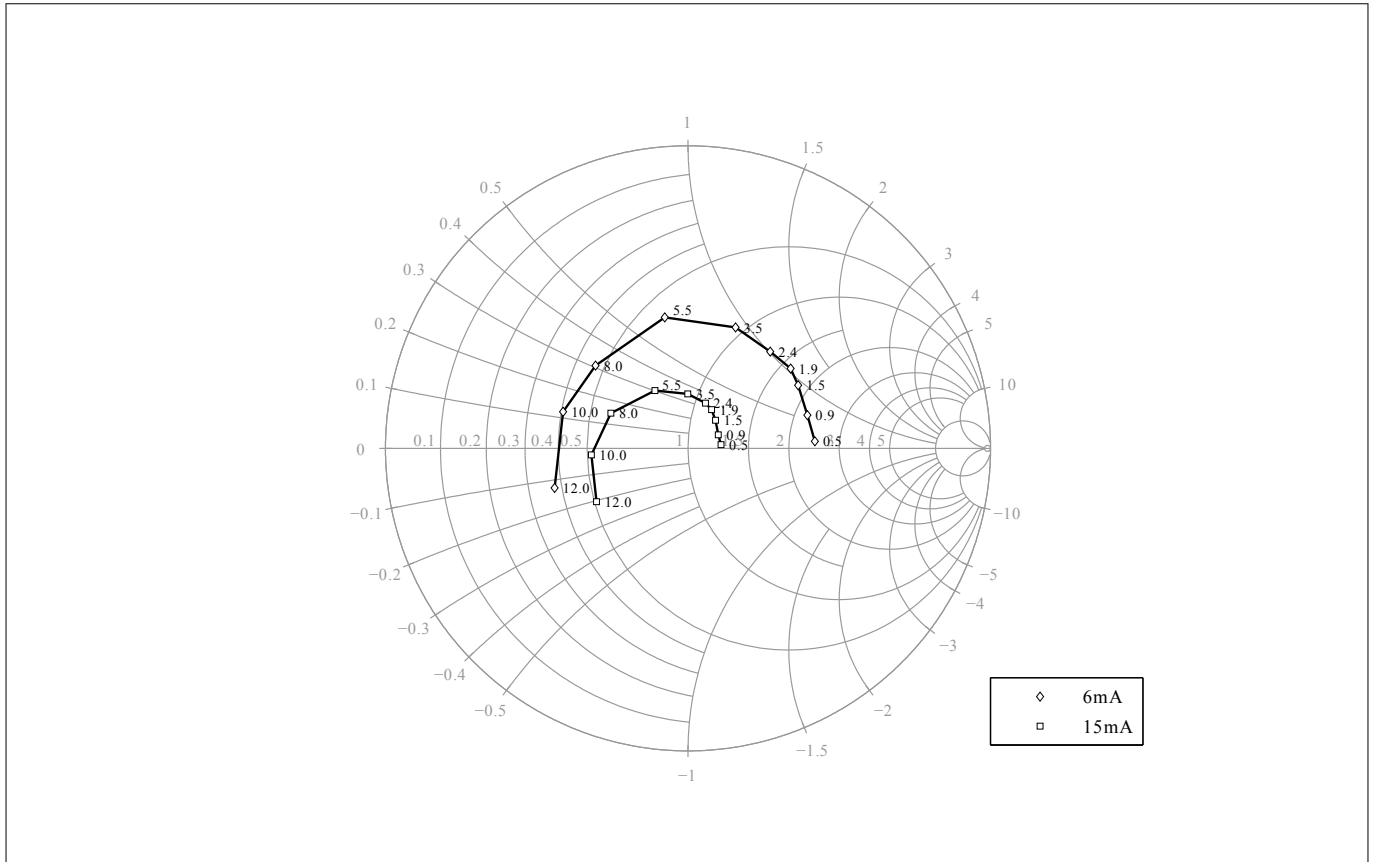


**Figure 16** Input reflection coefficient  $S_{11} = f(f)$ ,  $V_{CE} = 3\text{ V}$ ,  $I_C = 6 / 15\text{ mA}$

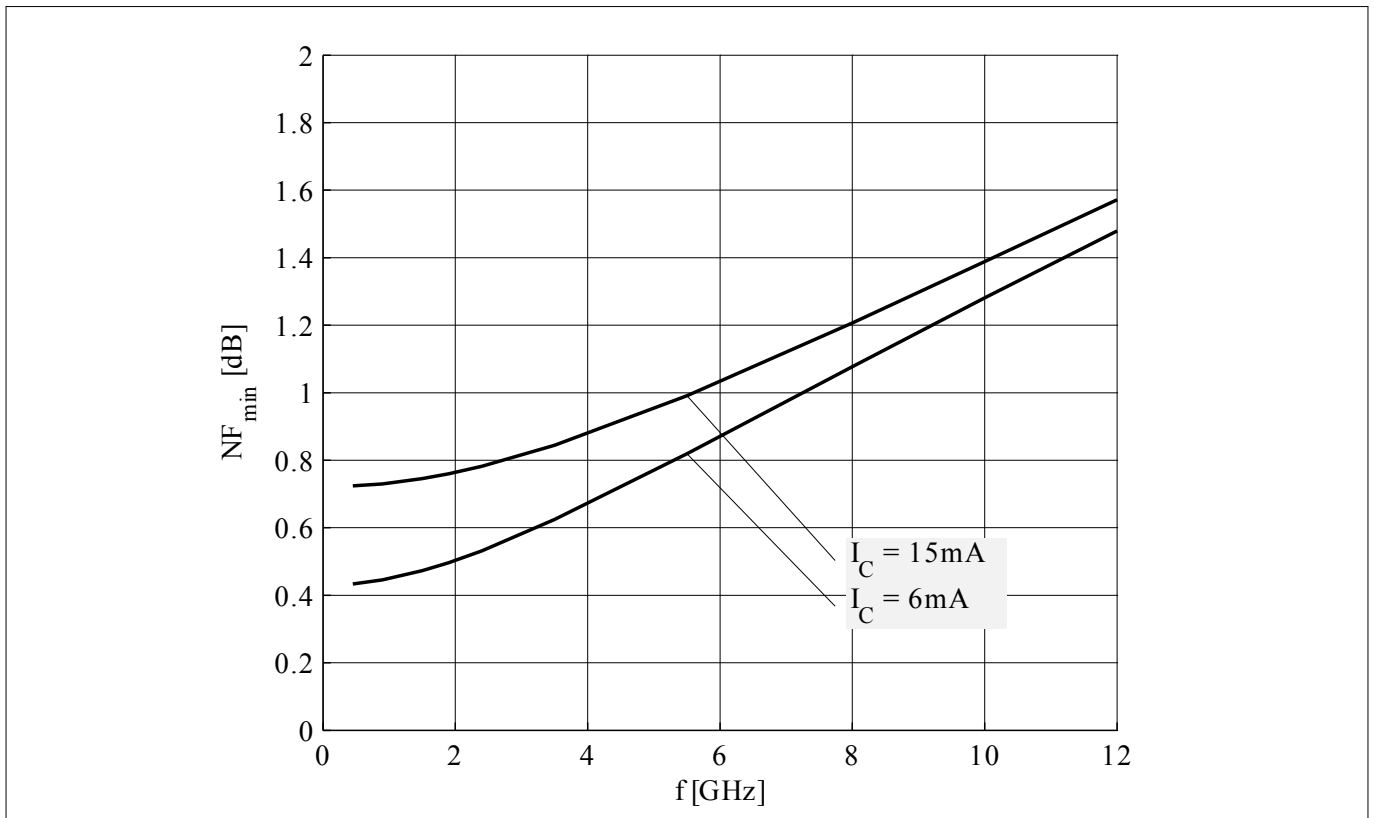


**Figure 17** Output reflection coefficient  $S_{22} = f(f)$ ,  $V_{CE} = 3\text{ V}$ ,  $I_C = 6 / 15\text{ mA}$

**Electrical characteristics**

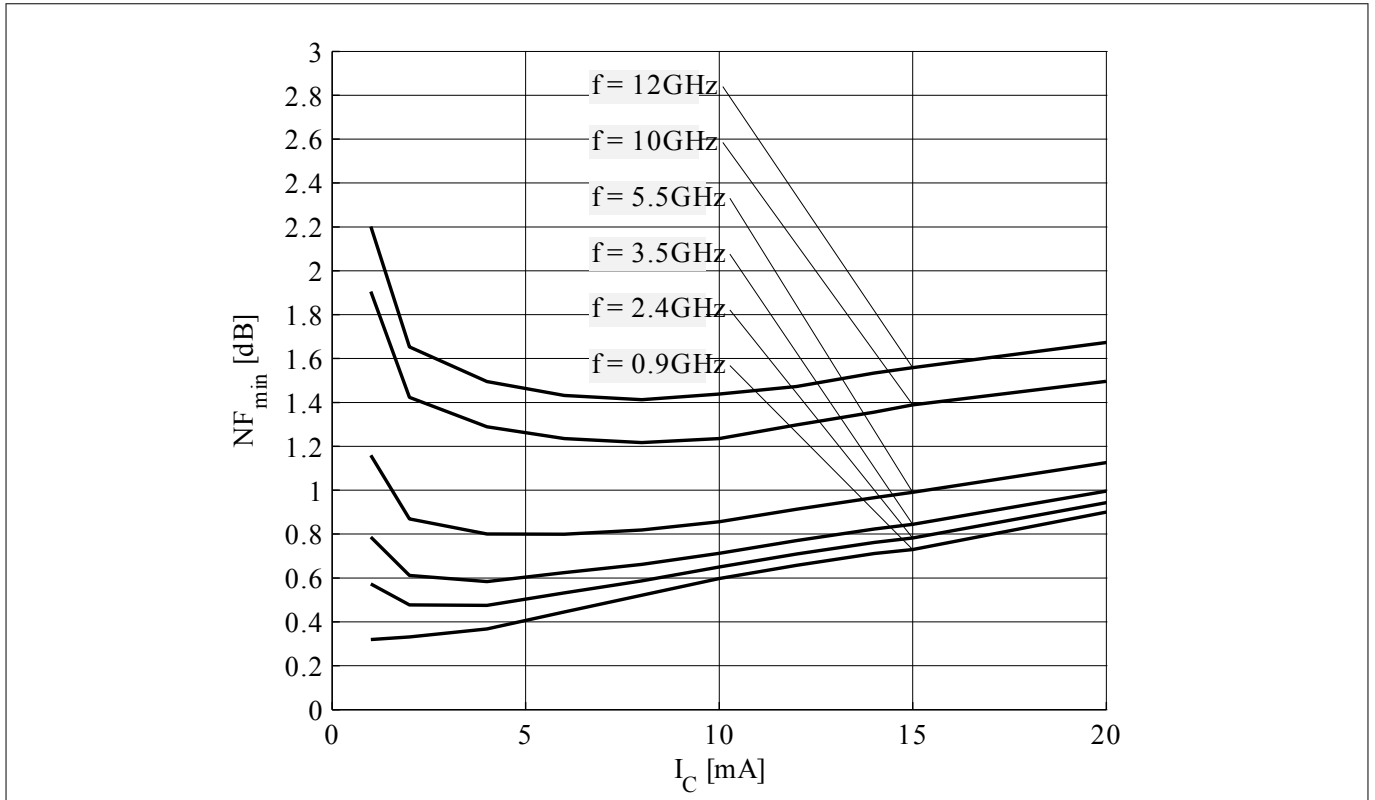


**Figure 18** Source impedance for minimum noise figure  $Z_{S,opt} = f(f)$ ,  $V_{CE} = 3\text{ V}$ ,  $I_C = 6 / 15\text{ mA}$

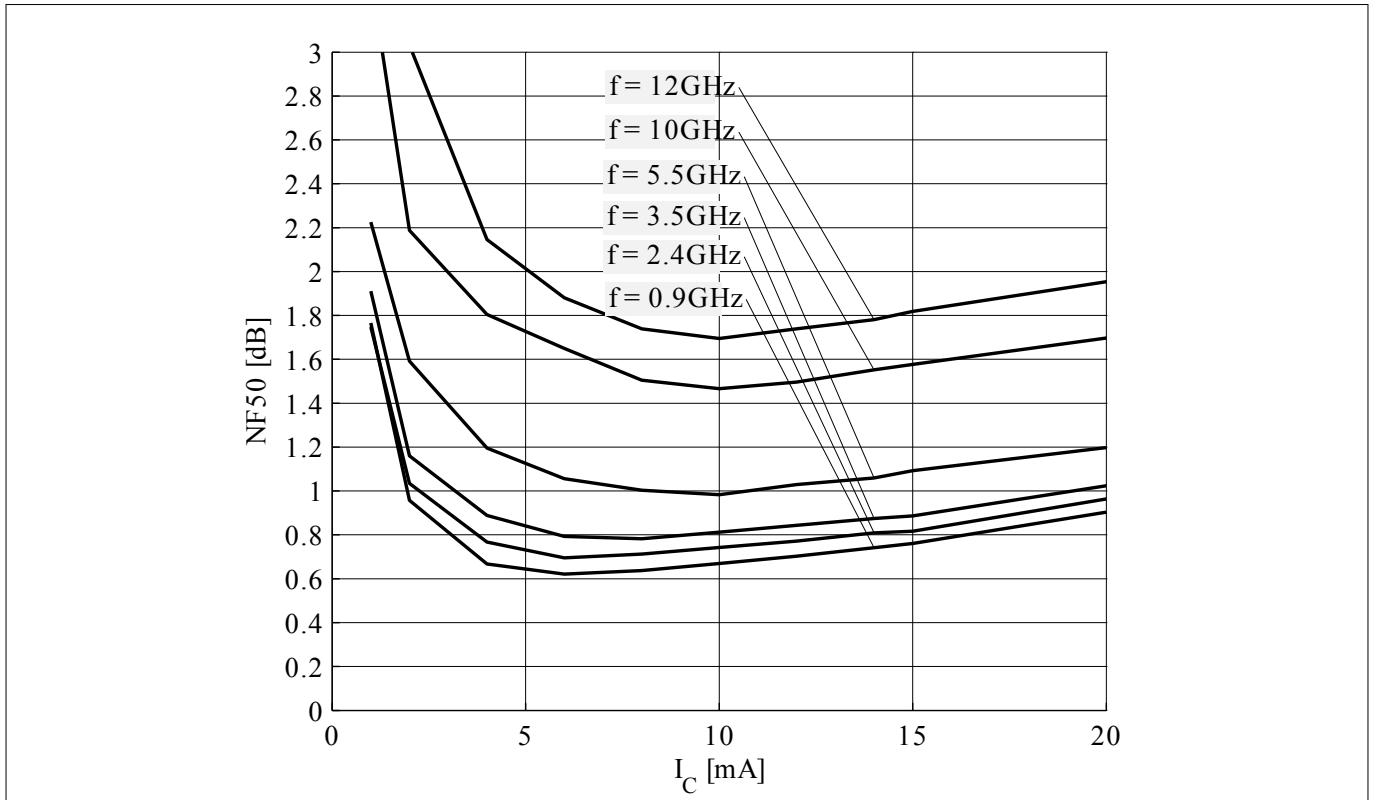


**Figure 19** Noise figure  $NF_{min} = f(f)$ ,  $V_{CE} = 3\text{ V}$ ,  $Z_S = Z_{S,opt}$ ,  $I_C = 6 / 15\text{ mA}$

**Electrical characteristics**



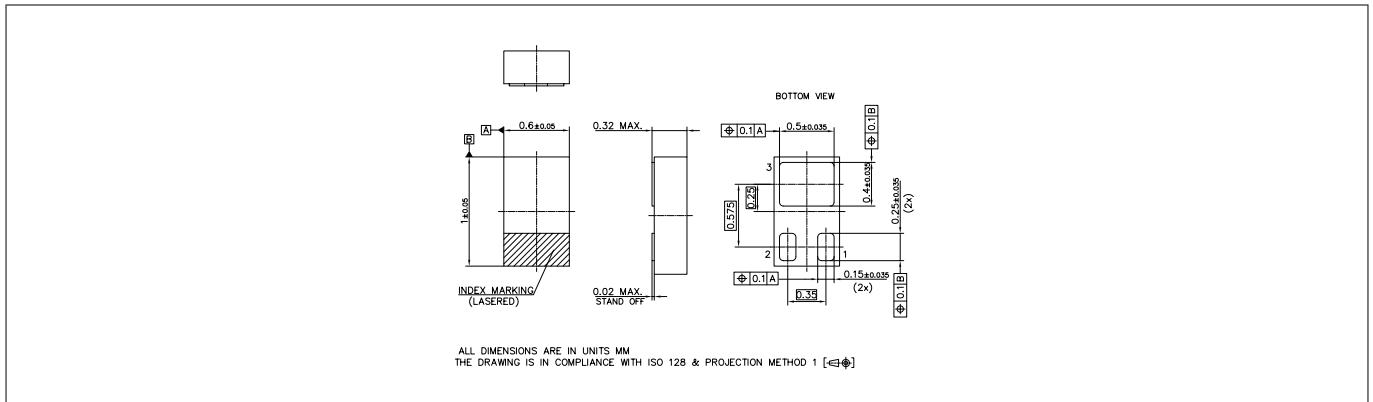
**Figure 20** Noise figure  $NF_{min} = f(I_C)$ ,  $V_{CE} = 3\text{ V}$ ,  $Z_S = Z_{S,opt}$ ,  $f = \text{parameter}$



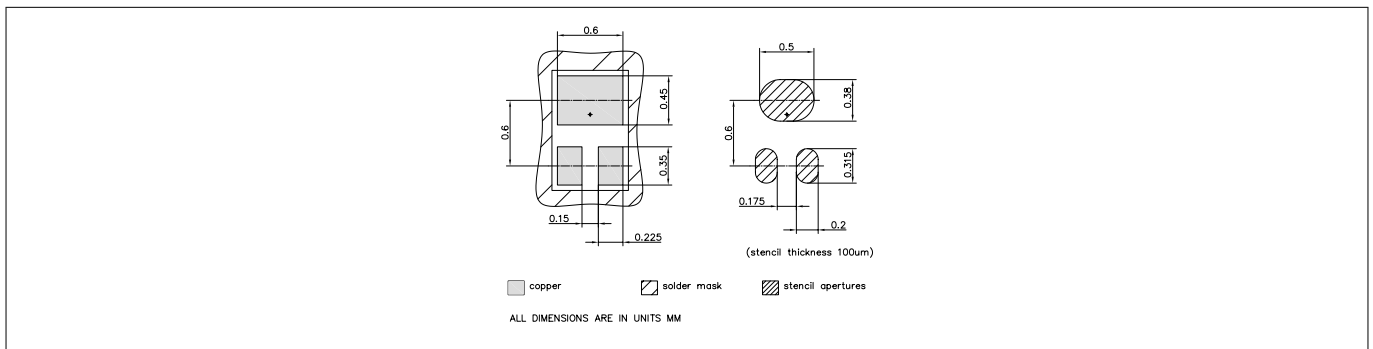
**Figure 21** Noise figure  $NF_{50} = f(I_C)$ ,  $V_{CE} = 3\text{ V}$ ,  $Z_S = 50\ \Omega$ ,  $f = \text{parameter}$

*Note:* The curves shown in this chapter have been generated using typical devices but shall not be considered as a guarantee that all devices have identical characteristic curves.  $T_A = 25\text{ }^\circ\text{C}$ .

## 4 Package information TSLP-3-10



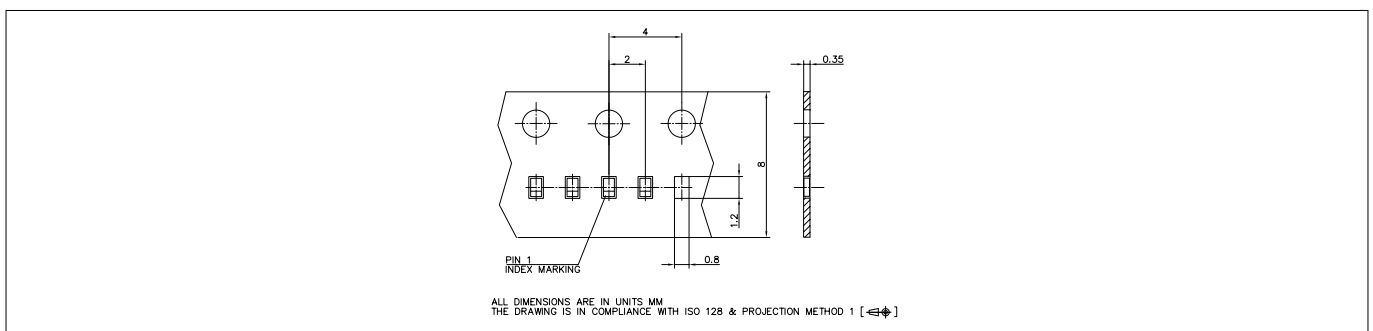
**Figure 22** Package outline



**Figure 23** Foot print



**Figure 24** Marking layout example



**Figure 25** Tape dimensions

*Note:* See our [Recommendations for Printed Circuit Board Assembly of TSLP/TSSLP/TSNP Packages](#). The marking layout is an example. For the real marking code refer to the device information on the first page. The number of characters shown in the layout example is not necessarily the real one. The marking layout can consist of less characters.

---

Revision history

## Revision history

Document version	Date of release	Description of changes
1.0	2018-09-26	First datasheet release.