

Features

- 600 V, 20 A, Low Collector-Emitter Saturation Voltage ($V_{CE(sat)}$)
- Trench-Gate Field-Stop technology
- Optimized for conduction
- Low switching loss
- RoHS compliant*

Applications

- Switch-Mode Power Supplies (SMPS)
- Uninterruptible Power Sources (UPS)
- Power Factor Correction (PFC)
- Stepper motors

BOURNS®

BIDW20N60T Insulated Gate Bipolar Transistor (IGBT)

General Information

The Bourns® Model BIDW20N60T IGBT device combines technology from a MOS gate and a bipolar transistor for an optimum component for high voltage and high current applications. This device uses Trench-Gate Field-Stop technology providing greater control of dynamic characteristics with a lower conduction loss and fewer switching losses. In addition, this structure provides a positive temperature coefficient.

Additional Information

Click these links for more information:



Maximum Electrical Ratings ($T_C = 25\text{ }^\circ\text{C}$, unless otherwise specified)

Parameter	Symbol	Value	Unit
Collector-Emitter Voltage	V_{CES}	600	V
Continuous Collector Current ($T_C = 25\text{ }^\circ\text{C}$), limited by T_{jmax}	I_C	40	A
Continuous Collector Current ($T_C = 100\text{ }^\circ\text{C}$), limited by T_{jmax}	I_C	20	A
Pulsed Collector Current, t_p limited by T_{jmax}	I_{CP}	60	A
Gate-Emitter Voltage	V_{GE}	± 20	V
Continuous Forward Current ($T_C = 25\text{ }^\circ\text{C}$), limited by T_{jmax}	I_F	40	A
Continuous Forward Current ($T_C = 100\text{ }^\circ\text{C}$), limited by T_{jmax}	I_F	20	A
Short-circuit Withstand Time ($V_{CE} = 300\text{ V}$, $V_{GE} = 15\text{ V}$)	T_{SC}	10	μs
Total Power Dissipation	P_{total}	192	W
Storage Temperature	T_{STG}	-55 to +150	$^\circ\text{C}$
Operating Junction Temperature	T_j	-55 to +150	$^\circ\text{C}$

Thermal Resistance

Parameter	Symbol	Max	Unit
IGBT Thermal Resistance Junction - Case	$R_{th(j-c)}_{IGBT}$	0.65	$^\circ\text{C/W}$
Diode Thermal Resistance Junction - Case	$R_{th(j-c)}_{Diode}$	1.19	$^\circ\text{C/W}$

Typical Part Marking

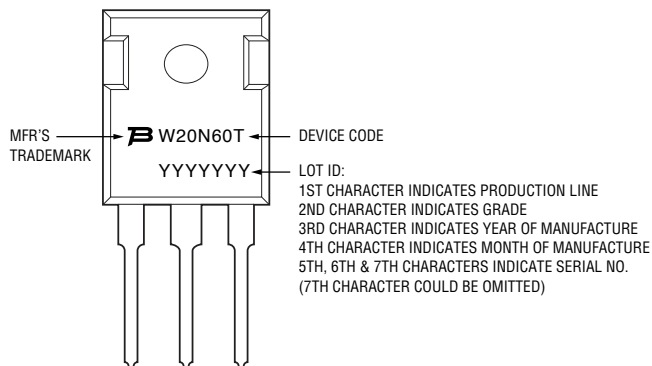

Internal Circuit

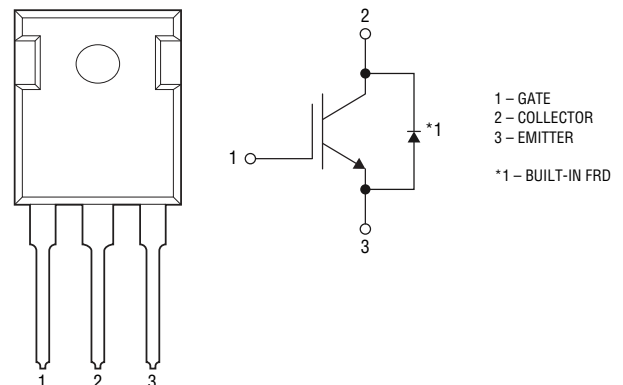

*RoHS Directive 2015/863, Mar 31, 2015 and Annex.

Specifications are subject to change without notice.

Users should verify actual device performance in their specific applications.

The products described herein and this document are subject to specific legal disclaimers as set forth on the last page of this document, and at www.bourns.com/docs/legal/disclaimer.pdf.



WARNING Cancer and Reproductive Harm

www.P65Warnings.ca.gov

BIDW20N60T Insulated Gate Bipolar Transistor (IGBT)

BOURNS®

Static Electrical Characteristics ($T_C = 25\text{ }^\circ\text{C}$, Unless Otherwise Specified)

Parameter	Symbol	Conditions	Value			Unit
			Min.	Typ.	Max.	
Collector-Emitter Breakdown Voltage	BV_{CES}	$V_{GE} = 0\text{ V}, I_C = 250\text{ }\mu\text{A}$	600	—	—	V
Collector-Emitter Saturation Voltage	$V_{CE(sat)}$	$V_{GE} = 15\text{ V}, I_C = 20\text{ A}$ $T_C = 25\text{ }^\circ\text{C}$	—	1.7	2.4	V
		$V_{GE} = 15\text{ V}, I_C = 20\text{ A}$ $T_C = 125\text{ }^\circ\text{C}$	—	1.9	—	
Diode Forward On-Voltage	V_F	$I_F = 20\text{ A}, T_C = 25\text{ }^\circ\text{C}$	—	1.8	—	V
		$I_F = 20\text{ A}, T_C = 125\text{ }^\circ\text{C}$	—	1.5	—	V
Gate Threshold Voltage	$V_{GE(th)}$	$V_{CE} = V_{GE}, I_C = 250\text{ }\mu\text{A}$	4.0	5.0	6.5	V
Collector Cut-off Current	I_{CES}	$V_{GE} = 0\text{ V}, V_{CE} = 600\text{ V}$	—	—	200	μA
Gate-Emitter Leakage Current	I_{GES}	$V_{CE} = 0\text{ V}, V_{GE} = \pm 20\text{ V}$	—	—	± 400	nA

Dynamic Electrical Characteristics ($T_C = 25\text{ }^\circ\text{C}$, Unless Otherwise Specified)

Parameter	Symbol	Conditions	Value			Unit
			Min.	Typ.	Max.	
Input Capacitance	C_{ies}	$V_{CE} = 30\text{ V}, V_{GE} = 0\text{ V},$ $f = 1\text{ MHz}$	—	1100	—	pF
Output Capacitance	C_{oes}		—	55	—	
Reverse Transfer Capacitance	C_{res}		—	22	—	
Total Gate Charge	Q_g	$V_{CE} = 400\text{ V}, V_{GE} = 15\text{ V}$ $I_C = 20.0\text{ A}$	—	52	—	nC
Gate-Emitter Charge	Q_{ge}		—	15	—	
Gate-Collector Charge	Q_{gc}		—	22	—	

IGBT Switching Characteristics (Inductive Load, $T_C = 25\text{ }^\circ\text{C}$, unless otherwise specified)

Parameter	Symbol	Conditions	Value			Unit
			Min.	Typ.	Max.	
Turn-on Delay Time	$t_{d(on)}$	$V_{CE} = 400\text{ V}, V_{GE} = 15\text{ V}$ $I_C = 20.0\text{ A}, R_G = 10\text{ }\Omega$	—	19	—	ns
Current Rise Time	t_r		—	55	—	ns
Turn-off Delay Time	$t_{d(off)}$		—	48	—	ns
Current Fall Time	t_f		—	115	—	ns
Turn-on Switching Energy	E_{on}		—	1	—	mJ
Turn-off Switching Energy	E_{off}		—	0.3	—	mJ
Total Switching Energy	E_{ts}		—	1.3	—	mJ

Specifications are subject to change without notice.

Users should verify actual device performance in their specific applications.

The products described herein and this document are subject to specific legal disclaimers as set forth on the last page of this document, and at www.bourns.com/docs/legal/disclaimer.pdf.

BIDW20N60T Insulated Gate Bipolar Transistor (IGBT)



Diode Switching Characteristics ($T_C = 25\text{ }^\circ\text{C}$, unless otherwise specified)

Parameter	Symbol	Conditions	Value			Unit
			Min.	Typ.	Max.	
Reverse Recovery Time	t_{rr}	$di_F/dt = 200\text{ A}/\mu\text{s}$ $I_F = 20.0\text{ A}$	—	33.7	—	ns
Reverse Recovery Charge	Q_{rr}		—	73.3	—	nC

Electrical Characteristic Performance

Typical Output Characteristics

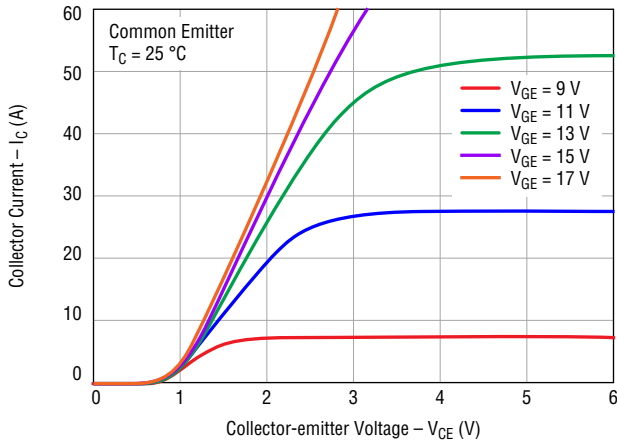

Typical Output Characteristics

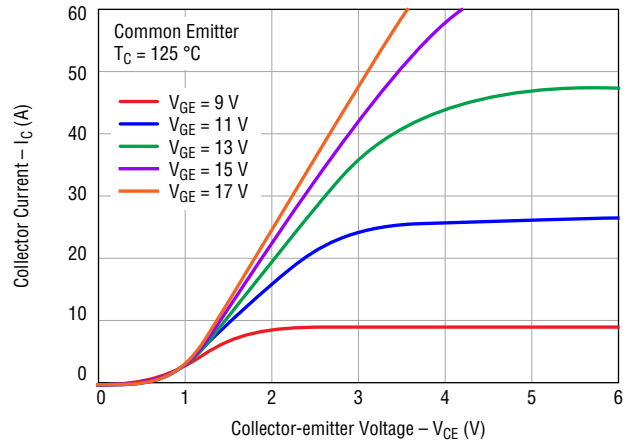

Typical Saturation Voltage Characteristics

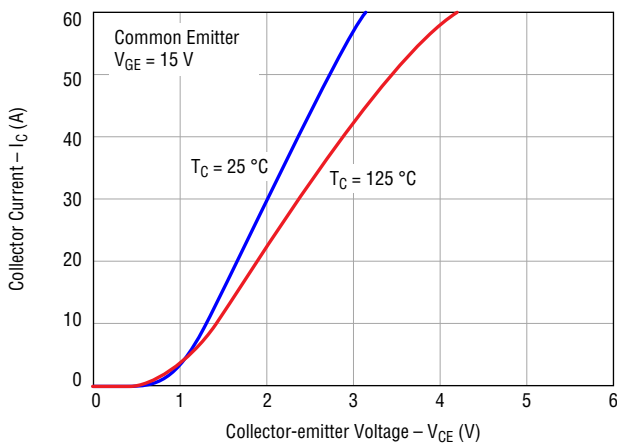

Typical Transfer Characteristics

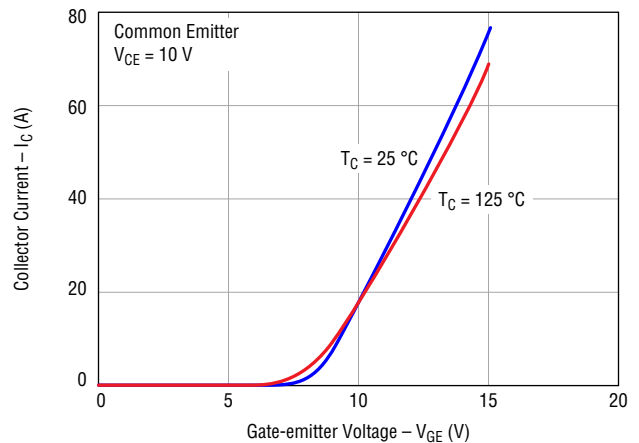

Specifications are subject to change without notice.

Users should verify actual device performance in their specific applications.

The products described herein and this document are subject to specific legal disclaimers as set forth on the last page of this document, and at www.bourns.com/docs/legal/disclaimer.pdf.

Electrical Characteristic Performance (continued)

Typical $V_{CE(sat)}$ vs V_{GE} @ $T_C = 25^\circ\text{C}$

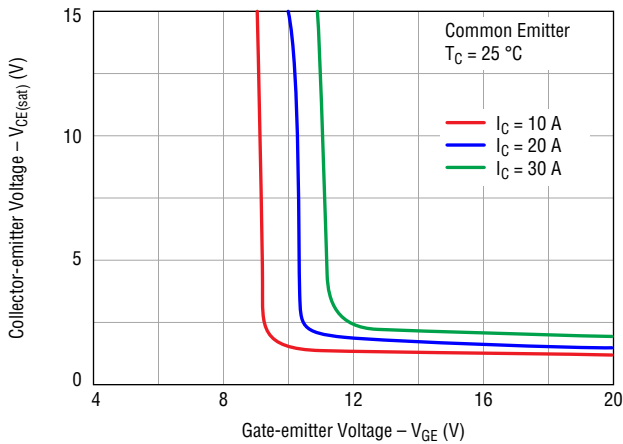

Typical $V_{CE(sat)}$ vs V_{GE} @ $T_C = 125^\circ\text{C}$

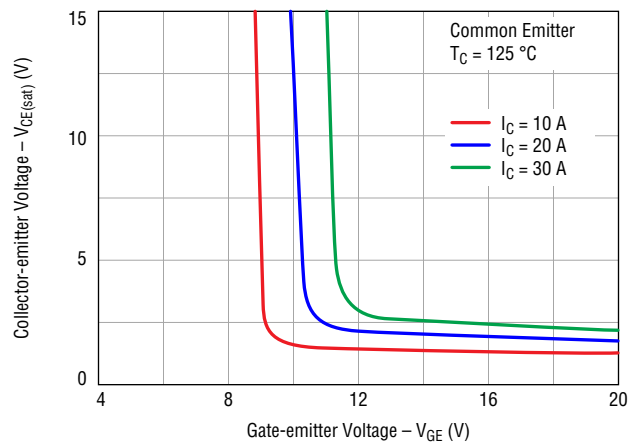

Typical $V_{CE(sat)}$ vs Case Temperature

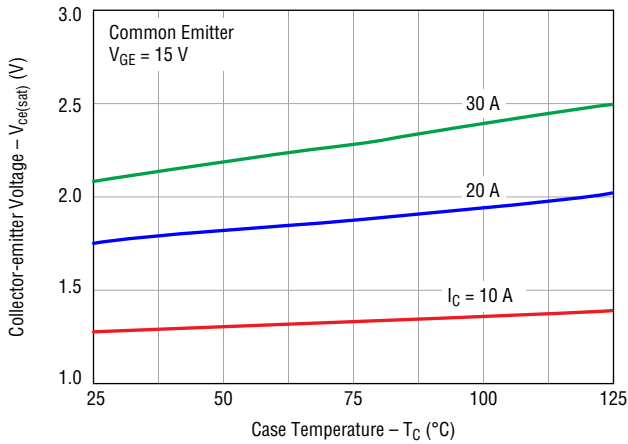

Typical Capacitance Characteristics

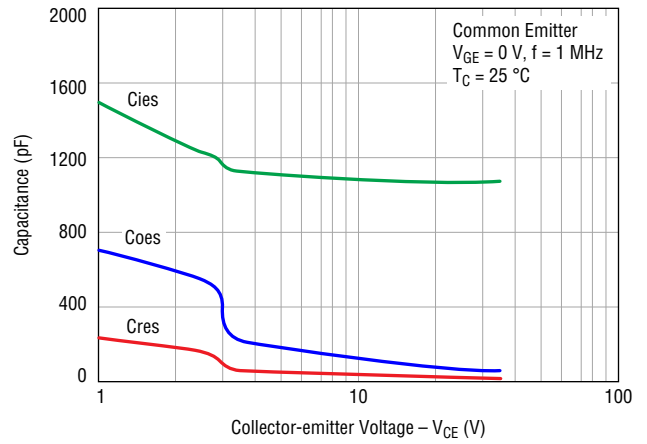

Specifications are subject to change without notice.

Users should verify actual device performance in their specific applications.

The products described herein and this document are subject to specific legal disclaimers as set forth on the last page of this document, and at www.bourns.com/docs/legal/disclaimer.pdf.

Electrical Characteristic Performance (continued)

Typical Gate Charge Characteristics

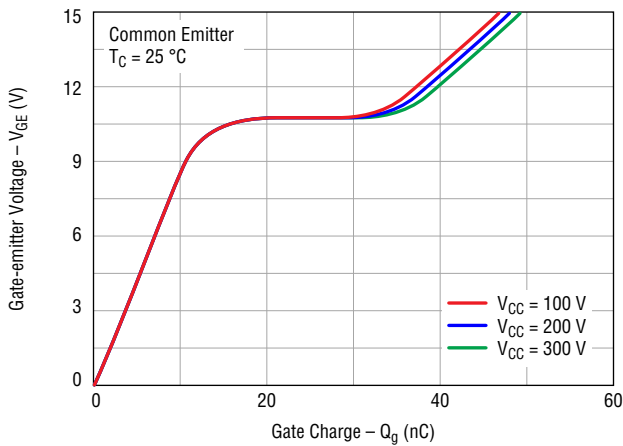

Typical Switching Time Characteristics vs R_G

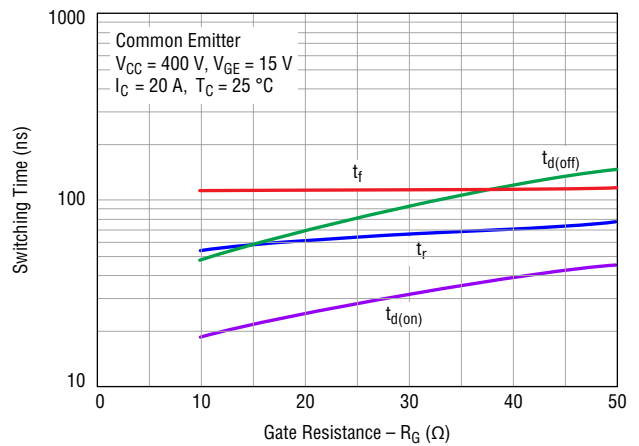

Typical Switching Time Characteristics vs I_C

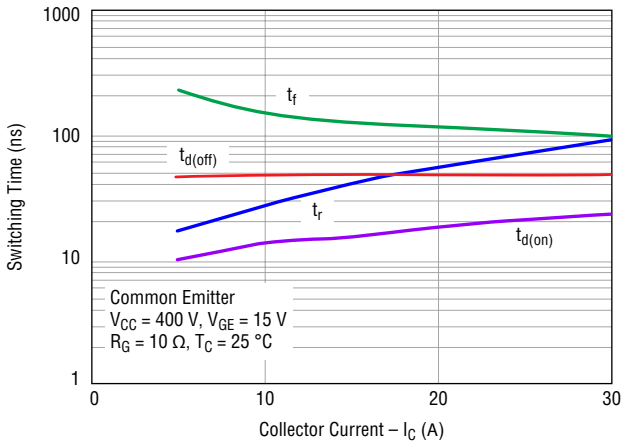

Typical Switching Loss vs R_G

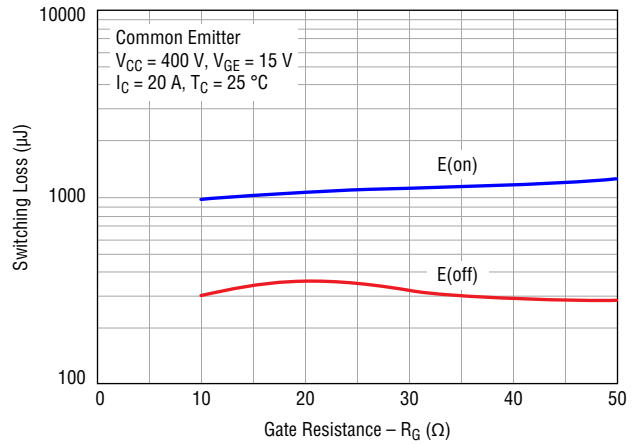

Specifications are subject to change without notice.

Users should verify actual device performance in their specific applications.

The products described herein and this document are subject to specific legal disclaimers as set forth on the last page of this document, and at www.bourns.com/docs/legal/disclaimer.pdf.

BIDW20N60T Insulated Gate Bipolar Transistor (IGBT)

BOURNS®

Electrical Characteristic Performance (continued)

Typical Switching Loss Characteristics vs I_C

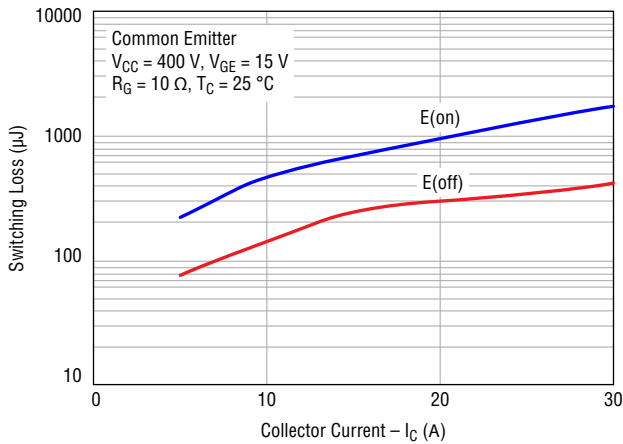

Typical Diode I_F vs V_F

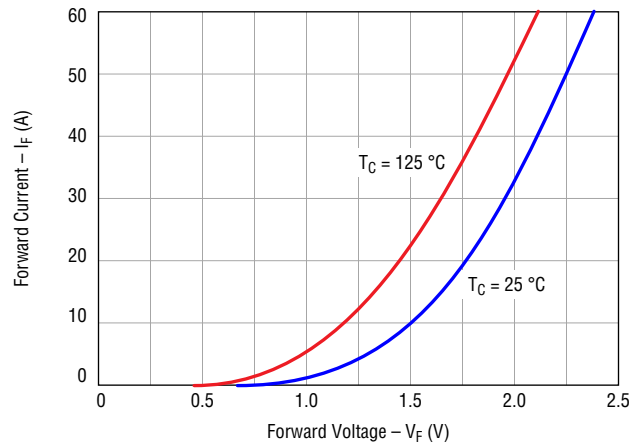

Typical Reverse Recovery Time vs I_F

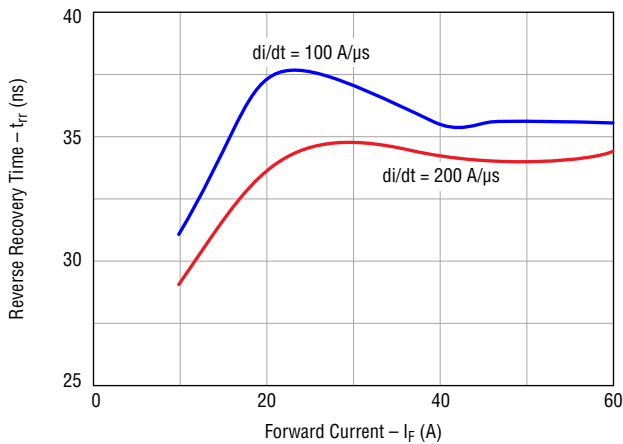

Typical Reverse Recovery Charge vs I_F

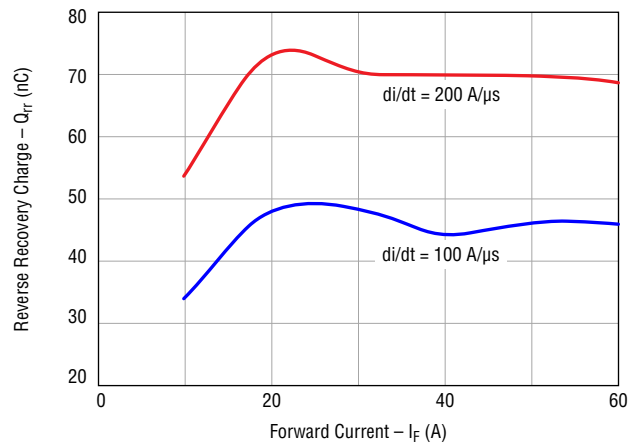

Specifications are subject to change without notice.

Users should verify actual device performance in their specific applications.

The products described herein and this document are subject to specific legal disclaimers as set forth on the last page of this document, and at www.bourns.com/docs/legal/disclaimer.pdf.

BIDW20N60T Insulated Gate Bipolar Transistor (IGBT)

BOURNS®

Electrical Characteristic Performance (continued)

IGBT Transient Thermal Impedance vs $t_{p(on)}$ Duration ($D=t_p/T$)

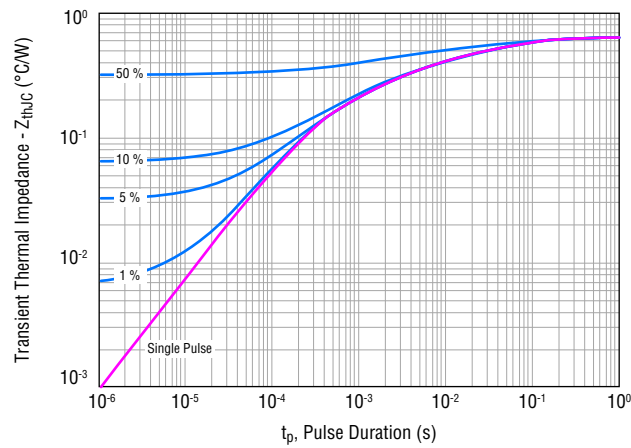

Diode Transient Thermal Impedance vs $t_{p(on)}$ Duration ($D=t_p/T$)

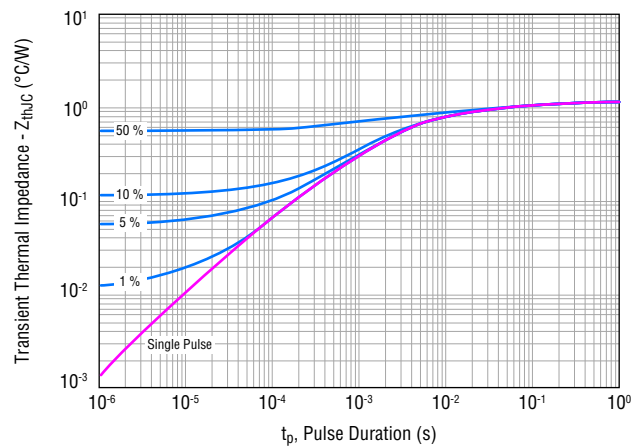

Specifications are subject to change without notice.

Users should verify actual device performance in their specific applications.

The products described herein and this document are subject to specific legal disclaimers as set forth on the last page of this document, and at www.bourns.com/docs/legal/disclaimer.pdf.

BIDW20N60T Insulated Gate Bipolar Transistor (IGBT)



Electrical Characteristic Performance (continued)

Forward Bias Safe Operating Area

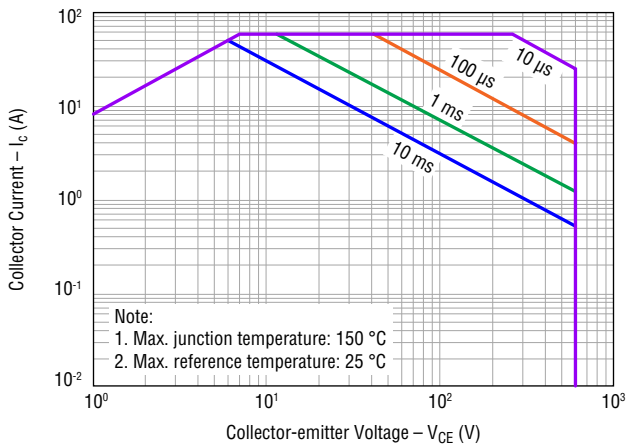

How to Order

B I D W 20 N 60 T

- B = Bourns®
- I = IGBT
- Type
D = Discrete
- Package Code
W = TO-247
- Current Rating
20 = 20 A
- Device Type
N = N-channel
- Nominal Voltage (divided by 10)
60 = 600 V
- Optimization
T = Medium Speed

Inductive Load Test Circuit

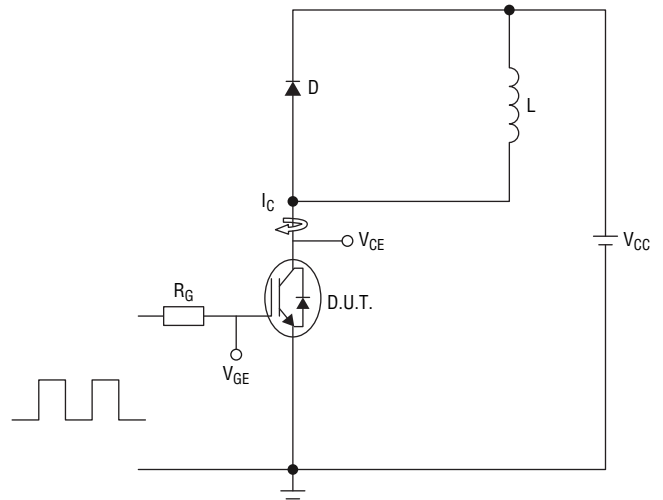

$L = 2.8 \text{ mH}$, $V_{CE} = 400 \text{ V}$, $V_{GE} = 15 \text{ V}$, $I_C = 20 \text{ A}$, $R_G = 10 \Omega$

Environmental Characteristics

ESD Class (HBM) 1C

BIDW20N60T Insulated Gate Bipolar Transistor (IGBT)



Product Dimensions

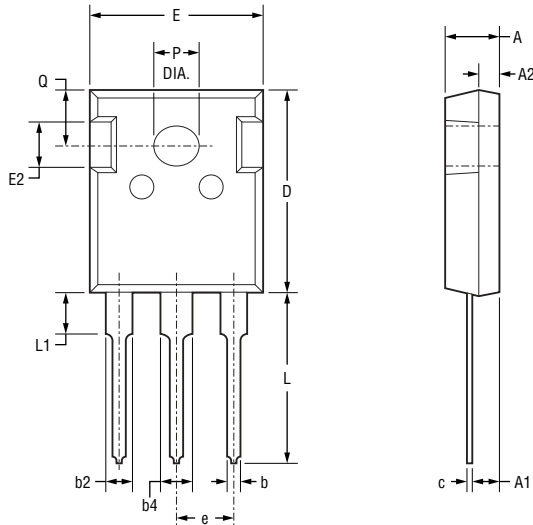

DIMENSIONS: $\frac{\text{MM}}{\text{(INCHES)}}$

Symbol	Min.	Nom.	Max.
A	$\frac{4.80}{(.189)}$	$\frac{5.00}{(.197)}$	$\frac{5.20}{(.205)}$
A1	$\frac{2.21}{(.087)}$	$\frac{2.41}{(.095)}$	$\frac{2.59}{(.102)}$
A2	$\frac{1.85}{(.073)}$	$\frac{2.00}{(.079)}$	$\frac{2.15}{(.085)}$
b	$\frac{1.11}{(.044)}$	—	$\frac{1.36}{(.054)}$
b2	$\frac{1.91}{(.075)}$	—	$\frac{2.25}{(.089)}$
b4	$\frac{2.91}{(.115)}$	—	$\frac{3.25}{(.128)}$
c	$\frac{0.51}{(.020)}$	—	$\frac{0.75}{(.030)}$
D	$\frac{20.80}{(.819)}$	$\frac{21.00}{(.827)}$	$\frac{21.30}{(.839)}$
E	$\frac{15.50}{(.610)}$	$\frac{15.80}{(.622)}$	$\frac{16.10}{(.634)}$
E2	$\frac{4.40}{(.173)}$	$\frac{5.00}{(.197)}$	$\frac{5.20}{(.205)}$
e	$\frac{5.44}{(.214)} \text{ BSC}$		
L	$\frac{19.72}{(.776)}$	$\frac{19.92}{(.784)}$	$\frac{20.22}{(.796)}$
L1	—	—	$\frac{4.30}{(.169)}$
P	$\frac{3.40}{(.134)}$	—	$\frac{3.80}{(.150)}$
Q	$\frac{5.60}{(.220)}$	$\frac{5.80}{(.228)}$	$\frac{6.00}{(.236)}$

Packaging Specifications

BIDW20N60T 30 pieces per tube



Asia-Pacific: Tel: +886-2 2562-4117

Email: asiacus@bourns.com

EMEA: Tel: +36 88 885 877

Email: eurocus@bourns.com

The Americas: Tel: +1-951 781-5500

Email: americus@bourns.com

www.bourns.com

07/22

Specifications are subject to change without notice.

Users should verify actual device performance in their specific applications.

The products described herein and this document are subject to specific legal disclaimers as set forth on the last page of this document, and at www.bourns.com/docs/legal/disclaimer.pdf.