

1AXXXX

PCB Fuse-clips for ATC/ATM Blade, 5 mm, 1/4" & 13/32" diameter fuses

For 1/4" diameter fuses

End stops

1A1119 Family
Angled-In leads

Dimensions - in (mm)

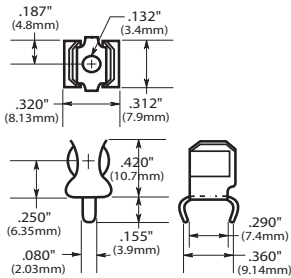

Catalog number ^{1,3}	Clip material ²	Finish
1A1119-04-R	Cu clad steel	Bright tin
1A1119-05	Cu clad steel	Silver
1A1119-10-R	Cartridge brass	Bright tin

RoHS

Without end stops

1A1120 Family
Angled-in leads

Dimensions - in (mm)

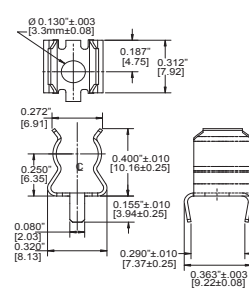

Catalog number ^{1,3}	Clip material ²	Finish
1A1120-05	Cu clad steel	Silver
1A1120-06-R	Cu clad steel	Bright tin
1A1120-09-R	Cartridge brass	Bright tin

RoHS

1A1907 Family
Straight leads

Dimensions - in (mm)

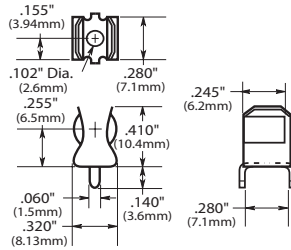

Catalog number ^{1,3}	Clip material ²	Finish
1A1907-02-R	Cartridge brass	Bright dipped
1A1907-03-R	Cu clad steel	Bright tin
1A1907-05	Cu clad steel	Silver
1A1907-06-R	Cartridge brass	Bright tin

UL recognized file number: E14853



RoHS

1A3398 Family
Straight leads

Dimensions - in (mm)

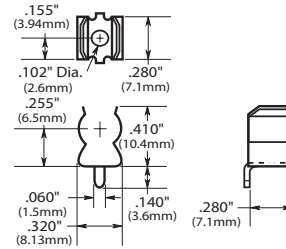

Catalog number ^{1,3}	Clip material ²	Finish
1A3398-07-R	Cartridge brass	Bright tin

RoHS

1A4534 Family
Angled out leads

Dimensions - in (mm)

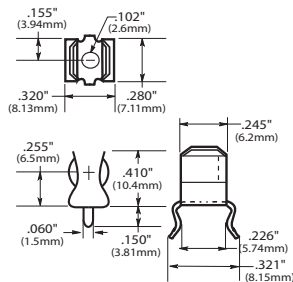

Catalog number ^{1,3}	Clip material ²	Finish
1A4534-01-R	Cu clad steel	Bright tin
1A4534-06-R	Cartridge brass	Bright tin

RoHS

1A4533 Family
Angled out leads

Dimensions - in (mm)

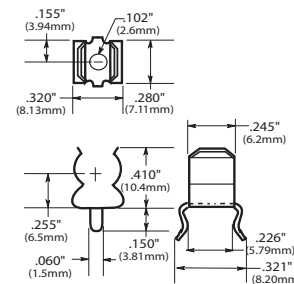

Catalog number ^{1,3}	Clip material ²	Finish
1A4533-01-R	Cu clad steel	Bright tin
1A4533-06-R	Cartridge brass	Bright tin

RoHS

Notes:

- All part numbers shown are RoHS compliant
- Add -BK prefix to part number for bulk packaging



Powering Business Worldwide

For 5 mm diameter fuses

1A5601 Family
Dimensions - in (mm)

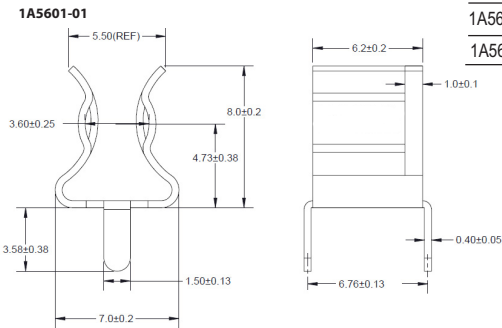
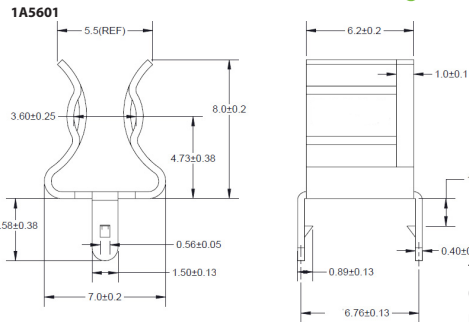

Catalog number ^{1,3}	Clip material ²	Finish	Nominal current maximum
1A5601	Cartridge brass	Bright tin	7 A
1A5601-01	Spring brass	Bright tin	10 A

1A5602 Family (<= 7 A nominal current)
Dimensions - in (mm)

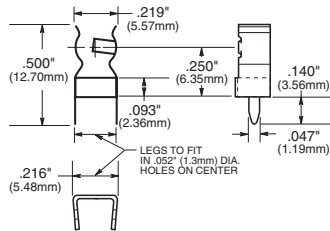

Catalog number ^{1,3}	Clip material ²	Finish
1A5602	Cartridge brass	Bright tin

1A3399 and 1A5018 Family
With straight leads



Dimensions - in (mm)

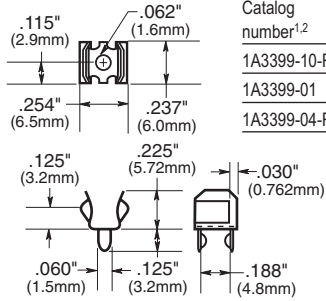

Catalog number ^{1,2}	Clip material	Finish
1A3399-10-R	Spring bronze	Bright tin
1A3399-01	Beryllium Cu	Silver
1A3399-04-R	Beryllium Cu	Bright tin

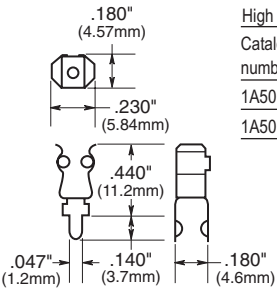

Catalog number ^{1,2}	Clip material	Finish
1A5018-10-R	Spring bronze	Bright tin
1A5018-07	Spring bronze	Silver

Notes:

1. All part numbers shown are RoHS compliant
2. Add -BK prefix to part number for bulk

For 1/32" diameter fuses

1A3400 Family
With end stops & straight leads
Dimensions - in (mm)

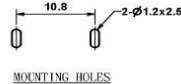
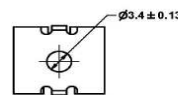
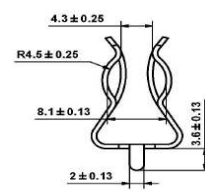
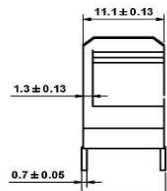
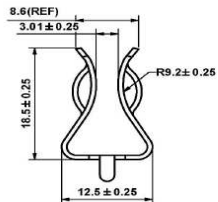
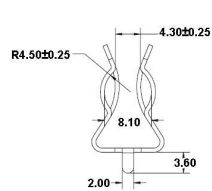
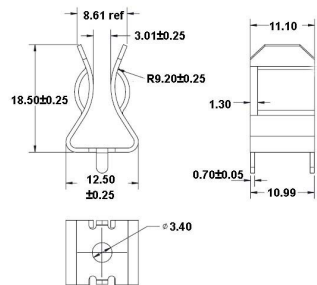

BK-1A3400-09

1A3400-12

Specifications:

Catalog number ^{1,2}	Clip material	Finish
BK-1A3400-09-R	Cartridge brass	Bright tin
1A3400-12-R	Cartridge brass	Bright tin

Notes:

1. All part numbers shown are RoHS compliant
2. Add -BK prefix to part number for bulk packaging

UL recognized file number: E14853

PCB Fuse-clips for ATC/ATM Blade, 5 mm, 1/4" & 13/32" diameter fuses



ATM Fuses 1A5778 Family
Dimensions - mm (in)

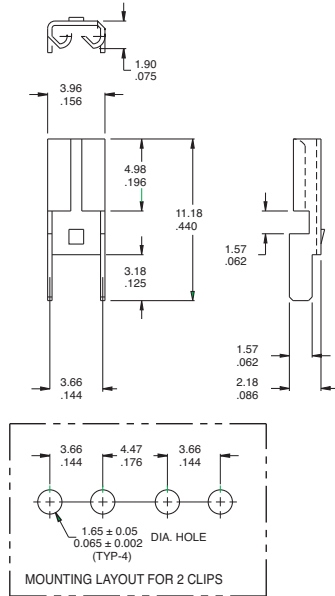

MATERIAL: BRASS, NICKEL PLATED, .30/.012 THICK

1A5779 Family

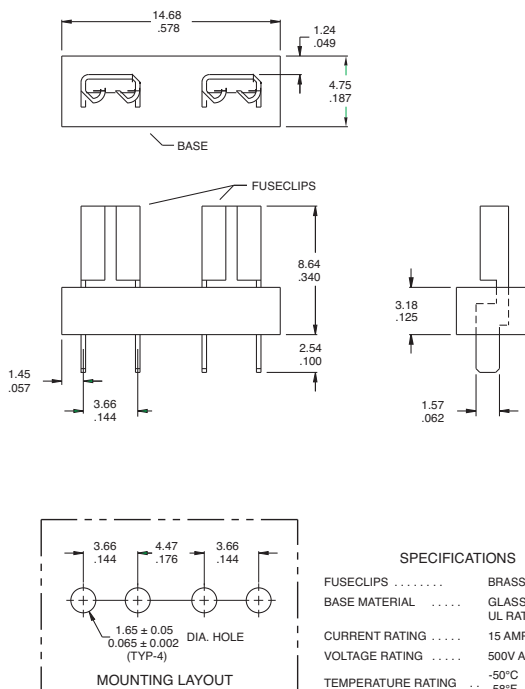

ATC Fuses (0 to 20 Amps)
1A5600 Family
Dimensions - in (mm)

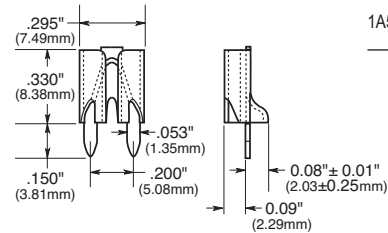

Catalog number	Clip material	Finish
1A5600	Cartridge brass	Matte tin

1A5780 Family
Dimensions - mm (in)

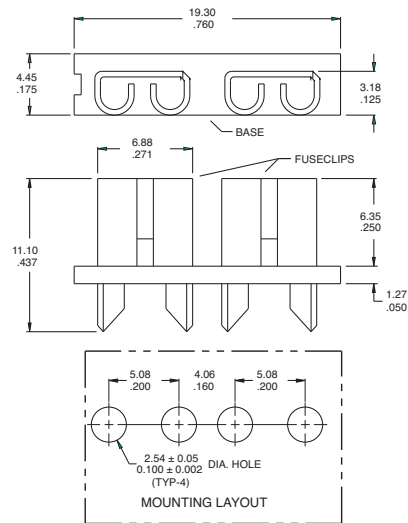

SPECIFICATIONS

FUSECLIPS	BRASS, NICKEL PLATED
BASE MATERIAL	GLASS FILLED NYLON, UL RATED 94V-0
CURRENT RATING	15 AMPS
VOLTAGE RATING	500V AC
TEMPERATURE RATING	-50°C TO 145°C -58°F TO 292°F