

BK-23134-000
SHT 1.1

NOTES:

- 1 A POSITIVE GOING VOLTAGE AT TERMINAL 2, RELATIVE TO TERMINAL 1, CAUSES A DECREASE IN PRESSURE AT THE SOUND OUTLET.
- 2 LOCATED FROM TWO SURFACES FOR CUSTOMER CONVENIENCE. ONLY APPLICABLE FROM ONE SURFACE, NOT TO BE USED TOGETHER. HORIZONTAL LOCATION FOR TERMINAL CENTERED TO $\pm 0,17$ [.007].

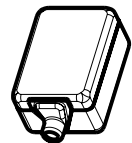
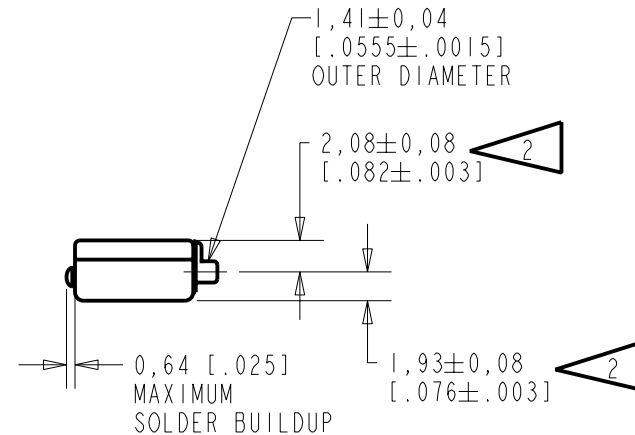
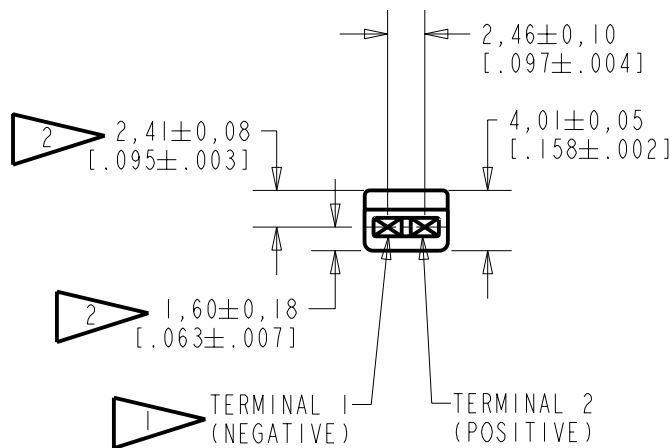
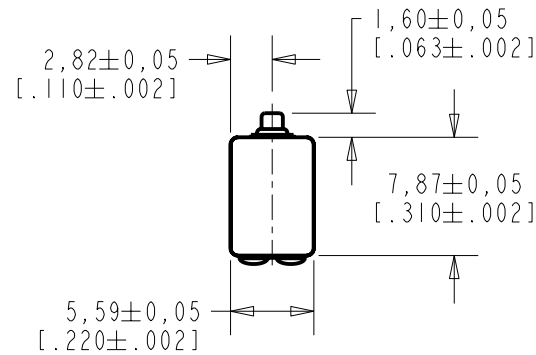

NOMINAL WEIGHT .66 GRAM DIMENSIONS IN MILLIMETERS [INCHES]

KNOWLES ELECTRONICS
ITASCA, ILLINOIS U.S.A.

Revision	C.O. #	Implementation Date	RELEASE LEVEL	REVISION
B	C10106382	8-23-07	Released	B
A	C10103338	11-4-05		

SCALE: 2:1		DR. BY	DATE
DO NOT SCALE DRAWING		MMM	11-4-05
TITLE: RECEIVER		CK. BY	DATE
OUTLINE DRAWING		GJP	11-8-05
BK-23134-000		APP. BY	DATE
SHT 1.1		GJP	11-8-05



NOTES:

1. MEASUREMENTS MADE USING 27,9mm (1.100") X 1,4mm (.053") ID+10,2mm(.400")x 1,8mm(.070") ID + 23,1mm(.201") x 3,0mm(.118") ID TUBE CONNECTED TO 2CC COUPLER (TI278 AND B & K DB0138)

2. SENSITIVITY

FREQUENCY	MIN.	MAX.
200	103.0	109.0
400	---	110.5
450	105.0	---
700	---	115.0
800	109.0	---
1000	---	126.0
1100	117.0	---
1500	112.0	126.0
3300	112.0	---
4000	---	126.0

- RESPONSE, IMPEDANCE, AND DISTORTION MEASUREMENTS MADE USING THE ELECTRICAL TEST CONDITIONS SHOWN BELOW.
- ELECTRICAL SOURCE IMPEDANCE MUST BE GREATER THAN 20 TIMES 1KHz IMPEDANCE FOR TEST CONDITIONS BELOW.
- INDIVIDUAL SPECIFICATIONS.

PORT LOCATION	IMPEDANCE OHMS ±15%		DCR @20°C OHMS ±10%	DISTORTION		ELECTRICAL TEST CONDITIONS	
	1KHz	500Hz		MAX. %	FREQ Hz	AC mA RMS	DC mA
12S	730	285	100	10	500	1.0	0.0

Revision	C.O. #	Implementation Date	RELEASE LEVEL	REVISION
B	C10106382	8-23-07	Released	B
A	C10103338	11-4-05		

KNOWLES ELECTRONICS
ITASCA, ILLINOIS U.S.A.

WHEN TEST LIMITS ARE USED TO ESTABLISH INCOMING INSPECTION ACCEPTANCE/REJECTION CRITERIA, CORRELATION OF TEST EQUIPMENT WITH KNOWLES IS ALSO REQUIRED FOR ELIMINATION OF EQUIPMENT AND TEST METHOD VARIATION

TITLE: **RECEIVER** **BK-23134-000**
PERFORMANCE SPECIFICATION **SHT 2.1**

DR. BY	DATE
MMM	11-4-05
CK. BY	DATE
GJP	11-8-05
APP. BY	DATE
GJP	11-8-05