

DATA SHEET

SPARK GAP PROTECTORS POWER SUPPLIES

BK2 series

RoHS compliant & Halogen free



Product specification— July 04, 2023 V.1



Spark Gap (SPG) Data Sheet

Features

- Approximately zero leaking current before clamping voltage
- Less decay at on/off state.
- High capability to withstand repeated lightning strikes.
- Low electrode capacitance($\leq 0.8\text{pF}$) and high isolation($\geq 100\text{M}\Omega$).
- RoHS compliant.
- Bilateral symmetrical.
- Temperature, humidity and lightness insensitive.
- Operating temperature: $-40^{\circ}\text{C} \sim +85^{\circ}\text{C}$
- Storage temperature: $-40^{\circ}\text{C} \sim +125^{\circ}\text{C}$
- Meets MSL level 1, per J-STD-020



Applications

- Power Supplies
- Motor sparks eliminating
- Relay switching spark absorbing
- Data line pulse guarding
- Telephone/Fax/Modem
- High frequency signal transmitters/receivers
- Satellite antenna
- Radio amplifiers
- Alarm systems
- Cathode ray tubes in Monitors/TVs

Dimensions

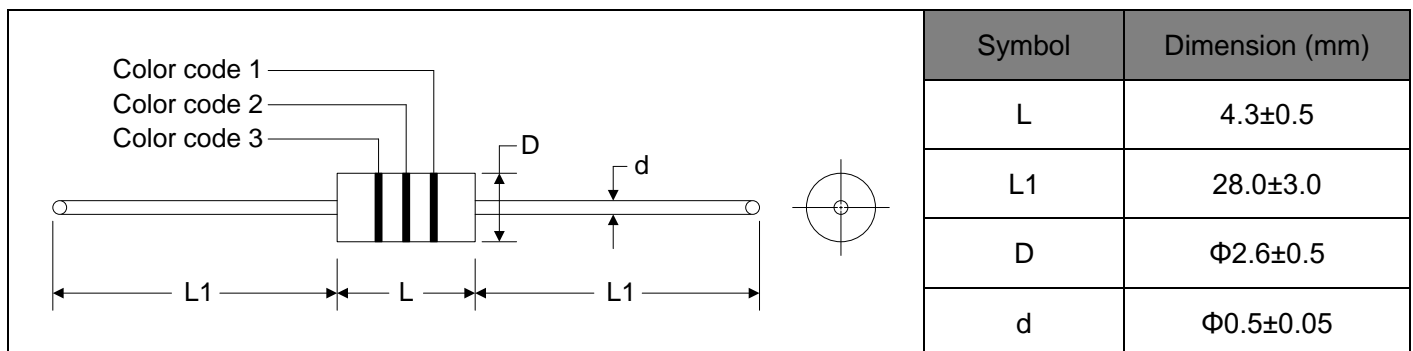

Electrical Characteristics

Part Number	DC Spark-over Voltage	Minimum Insulation Resistance		Maximum Capacitance (1KHz-6V _{MAX})	Surge Current Capacity (8/20μs)	Surge Life Test
	V _s (V)	Test Voltage(V)	I _{ROHM} (MΩ)	C(pf)		8/20μs, 100A
BK22000702	140 ± 20%	50	100	0.8	1000A	200 times
BK23000702	140 ± 30%	50	100	0.8	1000A	200 times
BK22001002	200 ± 20%	100	100	0.8	1000A	200 times
BK22001102	220 ± 20%	100	100	0.8	1000A	200 times
BK22001502	300 ± 20%	100	100	0.8	1000A	200 times
BK22002002	400 ± 20%	250	100	0.8	1000A	200 times
BK22002502	500 ± 20%	250	100	0.8	1000A	200 times
BK22003002	600 ± 20%	250	100	0.8	1000A	200 times
BK22003502	700 ± 20%	250	100	0.8	1000A	200 times
BK22005002	1000 ± 20%	500	100	0.8	1000A	200 times
BK22007502	1500 ± 20%	500	100	0.8	1000A	200 times

Color Code

Part Number	Color Code 1	Color Code 2	Color Code 3
BK22000702	Black	Yellow	-
BK23000702	Black	Yellow	-
BK22001002	Red	-	-
BK22001102	Red	Red	-
BK22001502	Orange	-	-
BK22002002	Yellow	-	-
BK22002502	Green	-	-
BK22003002	Blue	-	-
BK22003502	Purple	-	-
BK22005002	Black	-	-
BK22007502	Brown	Green	Red

Test Methods and Results

Items	Test Method	Standard						
DC Spark-over Voltage	Measure starting discharge voltage (Vs) by gradually increasing applied DC voltage. Test current is 0.5mA max. And the DC voltage ascends up within 100V/s(Vs<1000V) or 500V/s(Vs≥1000V).	Meet specified value.						
Insulation Resistance	Measure the insulation resistance across the terminal at regular voltage. But the test voltage doesn't over the DC spark-over voltage.							
Capacitance	Measure the electrostatic capacitance by applying a voltage of less than 6V (at 1KHz) between terminals.							
Static Life	10KV with 1500pf condenser is discharged through 0Ω resistor. 200 times at an interval of 10sec.	ΔVs/Vs ≤30% Characteristics of other items must meet the specified value.						
Surge Current Capacity	<p>The following impulse current for specified current applied ±5 times, each time interval 60 seconds. Thereafter, outer appearance shall be visually examined.</p> <table border="1"> <thead> <tr> <th>Type</th> <th>Impulse current</th> </tr> </thead> <tbody> <tr> <td>Vs < 400V</td> <td>1.2/50μs & 8/20μs, 1000A</td> </tr> <tr> <td>Vs ≥ 400V</td> <td>1.2/50μs & 8/20μs, 1000A, electrically connected with a resistor (1~2 Ω).</td> </tr> </tbody> </table>	Type	Impulse current	Vs < 400V	1.2/50μs & 8/20μs, 1000A	Vs ≥ 400V	1.2/50μs & 8/20μs, 1000A, electrically connected with a resistor (1~2 Ω).	No crack and no failures
Type	Impulse current							
Vs < 400V	1.2/50μs & 8/20μs, 1000A							
Vs ≥ 400V	1.2/50μs & 8/20μs, 1000A, electrically connected with a resistor (1~2 Ω).							
Cold Resistance	Measurement after -40°C/1000 HRS & normal temperature/2 HRS.	Features are conformed to rated spec.						
Heat Resistance	Measurement after 125°C/1000 HRS & normal temperature/2 HRS.							
Humidity Resistance	Measurement after humidity 90~95°C (45°C) /1000 HRS & normal temperature/2 HRS.							
Temperature Cycle	10 times repetition of cycle -40°C/30min →normal, temp/2 min →125°C/30min, measurement after normal temp/2 HRS.							
Solder Ability	Apply flux and immerse in molten solder 230±5°C for 3sec up to the point of 1.5mm from body. Check for solder adhesion.	Lead wire is evenly covered by solder.						
Solder Heat	Measurement after lead wire is dipped up to the point of 1.5mm from body into 260±5°C solder for 10sec.	Conformed to rated spec.						
Pull Strength	Apply 0.5kg load for 10sec.	Lead shall not pull out to snap.						
Flexural Strength	Bend lead wire at the point of 2mm from body under 0.25 load and back to its original point. Repeat 1 time.							

Recommended Soldering Conditions

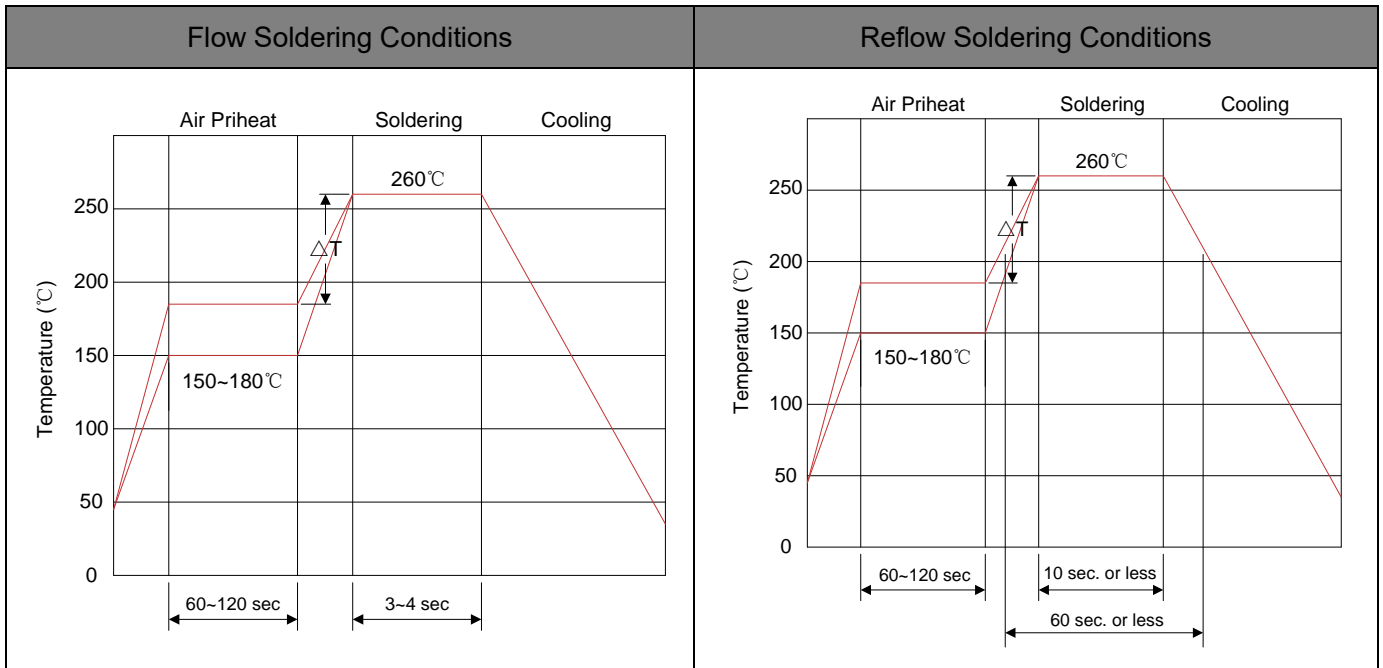

- 1) Time shown in the above figures is measured from the point when chip surface reaches temperature.
- 2) Temperature difference in high temperature part should be within 110°C.
- 3) After soldering, do not force cool, allow the parts to cool gradually.

Hand Soldering

Solder iron temperature: 350±5°C

Heating time: 3 seconds max.

General attention to soldering

- High soldering temperatures and long soldering times can cause leaching of the termination, decrease in adherence strength, and the change of characteristic may occur.
- For soldering, please refer to the soldering curves above. However, please keep exposures to temperatures exceeding 200°C to fewer than 50 seconds.
- Please use a mild flux (containing less than 0.2wt% Cl). Also, if the flux is water soluble, be sure to wash thoroughly to remove any residue from the underside of components that could affect resistance.

Cleaning

When using ultrasonic cleaning, the board may resonate if the output power is too high. Since this vibration can cause cracking or a decrease in the adherence of the termination, we recommend that you use the conditions below.

Frequency: 40kHz max.

Output power: 20W/liter

Cleaning time: 5 minutes max.

Packaging

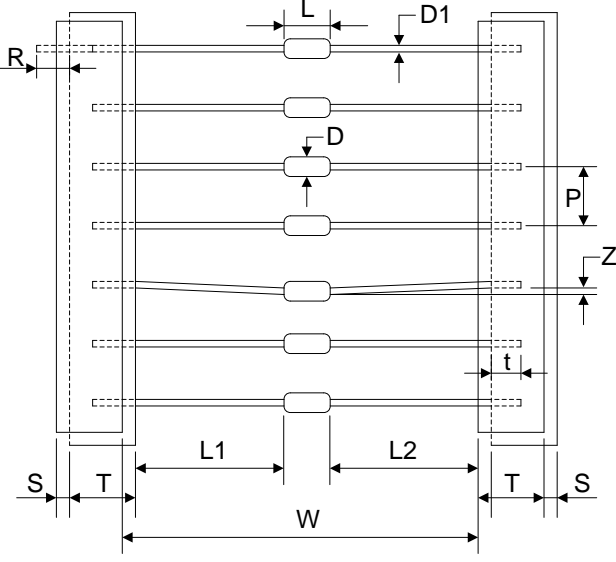
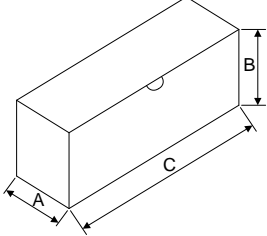
Tape	Symbol	Dimension (mm)	
	W	52.0±1.5	
	P	5.0±0.5	
	L1-L2	1.0max.	
	T	6.0±1.0	
	Z	1.2max.	
	R	Terminals must not project from tape.	
	t	3.2max.	
	S	0.8max.	
	D	Φ3.1max.	
	D1	Φ0.5±0.05	
	L	4.8max.	
	<p data-bbox="108 1016 231 1048">Inner Box</p> 	A	74.0±5.0
		B	77.0±5.0
		C	252.0±5.0
	Quantity: 2500PCS		