

# Reference Only

## Chip Ferrite Bead BLM03□□□□SZ1D

### Murata Standard Reference Specification [AEC-Q200]

#### 1.Scope

This reference specification applies to Chip Ferrite Bead BLM03\_SZ series for Automotive Electronics based on AEC-Q200 except for Power train and Safety.

#### 2.Part Numbering

(ex.) BL M 03 AG 102 S Z 1 D  
 (1) (2) (3) (4) (5) (6) (7) (8) (9)  
 (1)Product ID (4)Characteristics (7)Category(for Automotive Electronics)  
 (2)Type (5)Typical Impedance at 100MHz (8)Numbers of Circuit  
 (3)Dimension (L×W) (6)Performance (9)Packaging (D:Taping)

#### 3.Rating

| Customer Part Number | MURATA Part Number | Impedance (Ω)<br>(at 100MHz)(*1)<br>(refer to below comment) | Rated Current (mA) (*2) |                    | DC Resistance (Ω max.) (*1)<br>(refer to below comment) |                      | Remark                     | ESD Rank 2 :2kV |
|----------------------|--------------------|--|-------------------------|--------------------|---|----------------------|----------------------------|-----------------|
|                      |                    |  | at 85°C                 | at 125°C           | Initial Values  | Values After Testing |                            |                 |
|                      |                    |  |                         |                    |   |                      |                            |                 |
|                      | BLM03AG100SZ1D     | 5~15   | 500                     |                    | 0.1   | 0.15                 | For general use            |                 |
|                      | BLM03AG700SZ1D     | 40~100   | 200                     |                    | 0.4   | 0.5                  |                            |                 |
|                      | BLM03AG800SZ1D     | 80±25%   | 200                     |                    | 0.4   | 0.5                  |                            |                 |
|                      | BLM03AG121SZ1D     | 120±25%  | 200                     |                    | 0.5   | 0.6                  |                            |                 |
|                      | BLM03AG241SZ1D     | 240±25%  | 200                     |                    | 0.8   | 0.9                  |                            |                 |
|                      | BLM03AG601SZ1D     | 600±25%  | 100                     |                    | 1.5   | 1.6                  |                            |                 |
|                      | BLM03AG102SZ1D     | 1000±25%   | 100                     |                    | 2.5   | 2.6                  |                            |                 |
|                      | BLM03AX100SZ1D     | 5~15   | 1000                    |                    | 0.05  | 0.10                 |                            |                 |
|                      | BLM03AX800SZ1D     | 80±25%   | 500                     |                    | 0.18  | 0.23                 |                            |                 |
|                      | BLM03AX121SZ1D     | 120±25%  | 450                     |                    | 0.23  | 0.28                 |                            |                 |
|                      | BLM03AX241SZ1D     | 240±25%  | 350                     |                    | 0.38  | 0.43                 |                            |                 |
|                      | BLM03AX601SZ1D     | 600±25%  | 250                     |                    | 0.85  | 0.90                 |                            |                 |
|                      | BLM03AX102SZ1D     | 1000±25%   | 200                     |                    | 1.25  | 1.30                 |                            |                 |
|                      | BLM03BB100SZ1D     | 10±25%   | 300                     |                    | 0.4   | 0.5                  | For high speed signal Line | 2               |
|                      | BLM03BB220SZ1D     | 22±25%   | 200                     |                    | 0.5   | 0.6                  |                            |                 |
|                      | BLM03BB470SZ1D     | 47±25%   | 200                     |                    | 0.7   | 0.8                  |                            |                 |
|                      | BLM03BB750SZ1D     | 75±25%   | 200                     |                    | 1.0   | 1.1                  |                            |                 |
|                      | BLM03BB121SZ1D     | 120±25%  | 100                     |                    | 1.5   | 1.6                  |                            |                 |
|                      | BLM03BC330SZ1D     | 33±25%   | 150                     |                    | 0.85  | 0.90                 |                            |                 |
|                      | BLM03BC560SZ1D     | 56±25%   | 100                     |                    | 1.05  | 1.10                 |                            |                 |
|                      | BLM03BC800SZ1D     | 80±25%   | 100                     |                    | 1.40  | 1.45                 |                            |                 |
|                      | BLM03BD750SZ1D     | 75±25%   | 300                     |                    | 0.4   | 0.5                  |                            |                 |
|                      | BLM03BD121SZ1D     | 120±25%  | 250                     |                    | 0.5   | 0.6                  |                            |                 |
|                      | BLM03BD241SZ1D     | 240±25%  | 200                     |                    | 0.8   | 0.9                  |                            |                 |
|                      | BLM03BD471SZ1D     | 470±25%  | 215                     |                    | 1.5   | 1.6                  |                            |                 |
|                      | BLM03BD601SZ1D     | 600±25%  | 200                     |                    | 1.7   | 1.8                  |                            |                 |
|                      | BLM03PG220SZ1D     | 22±25%   | 900                     |                    | 0.065   | 0.115                | For DC power Line          |                 |
|                      | BLM03PG330SZ1D     | 33±25%   | 750                     |                    | 0.09  | 0.140                |                            |                 |
|                      | BLM03PX220SZ1D     | 22±25%   | 1800 <sup>*2</sup>      | 1450 <sup>*2</sup> | 0.040   | 0.045                |                            |                 |
|                      | BLM03PX330SZ1D     | 33±25%   | 1500 <sup>*2</sup>      | 1200 <sup>*2</sup> | 0.055   | 0.060                |                            |                 |
|                      | BLM03PX800SZ1D     | 80±25%   | 1000 <sup>*2</sup>      | 800 <sup>*2</sup>  | 0.130   | 0.135                |                            |                 |
|                      | BLM03PX121SZ1D     | 120±25%  | 900 <sup>*2</sup>       | 700 <sup>*2</sup>  | 0.160   | 0.210                |                            |                 |

■ Operating Temperature : -55°C to +125°C    ■ Storage Temperature : -55°C to +125°C

(\*1)

**Standard Testing Conditions**

< Unless otherwise specified >

Temperature : Ordinary Temp. (15 °C to 35 °C)

Humidity : Ordinary Humidity (25%(RH) to 85%(RH))

< In case of doubt >

Temperature : 20°C±2 °C

Humidity : 60%(RH) to 70%(RH)

Atmospheric pressure : 86kPa to 106kPa

(\*2)

As for the Rated current marked with \*2  
Rated Current is derated as right figure  
Depending on the operating temperature.

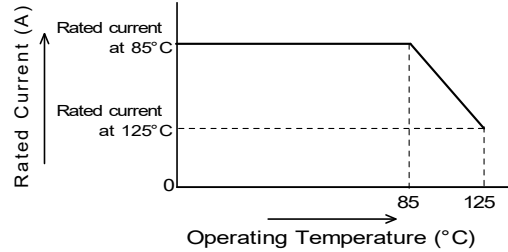

**4.Style and Dimensions**

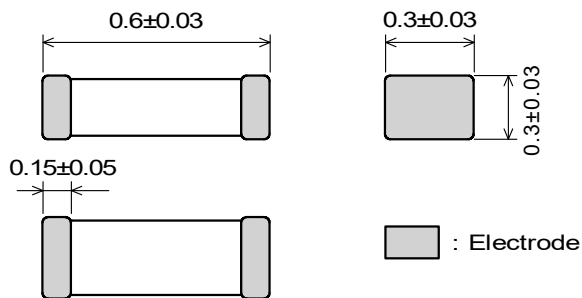

■ Equivalent Circuit

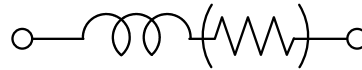

( Resistance element becomes dominant at high frequencies. )

■ Unit Mass (Typical value)  
0.3mg

**5.Marking**

No marking.

**6.Specifications**

**6-1.Electrical Performance**

| No.   | Item          | Specification | Test Method   |
|-------|---------------|---------------|---|
| 6-1-1 | Impedance     | Meet item 3.  | Measuring Frequency : 100MHz±1MHz<br>Measuring Equipment : KEYSIGHT4291A or the equivalent<br>Test Fixture : KEYSIGHT16192A or the equivalent |
| 6-1-2 | DC Resistance | Meet item 3.  | Measuring Equipment : Digital multi meter<br>* Except resistance of the Substrate and Wire  |

# Reference Only

**6-2.Mechanical Performance (based on Table 13 for FILTER EMI SUPPRESSORS/FILTERS)**  
**AEC-Q200 Rev.D issued June. 1 2010**

| AEC-Q200                     |                                 |  | Murata Specification / Deviation  |            |           |                              |             |               |              |
|------------------------------|---------------------------------|--|---|------------|-----------|------------------------------|-------------|---------------|--------------|
| No.                          | Stress                          | Test Method  |   |            |           |                              |             |               |              |
| 3                            | High Temperature Exposure       | 1000hours at 125 deg C<br>Set for 24hours at room temperature, then measured.                | Meet Table A after testing.<br><u>Table A</u><br><table border="1" style="margin-left: auto; margin-right: auto;"> <tr> <td style="padding: 2px;">Appearance</td> <td style="padding: 2px;">No damage</td> </tr> <tr> <td style="padding: 2px;">Impedance Change (at 100MHz)</td> <td style="padding: 2px;">Within ±30%</td> </tr> <tr> <td style="padding: 2px;">DC Resistance</td> <td style="padding: 2px;">Meet item 3.</td> </tr> </table> | Appearance | No damage | Impedance Change (at 100MHz) | Within ±30% | DC Resistance | Meet item 3. |
| Appearance                   | No damage                       |  |   |            |           |                              |             |               |              |
| Impedance Change (at 100MHz) | Within ±30%                     |  |   |            |           |                              |             |               |              |
| DC Resistance                | Meet item 3.                    |  |   |            |           |                              |             |               |              |
| 4                            | Temperature Cycling             | 1000cycles<br>-55 deg C to +125 deg C<br>Set for 24hours at room temperature, then measured. | Meet Table A after testing.   |            |           |                              |             |               |              |
| 5                            | Destructive Physical Analysis   | Per EIA469<br>No electrical tests  | No defects  |            |           |                              |             |               |              |
| 7                            | Biased Humidity                 | 1000hours at 85 deg C, 85%RH<br>Apply max rated current.                                     | Meet Table A after testing.   |            |           |                              |             |               |              |
| 8                            | Operational Life                | Apply 125 deg C 1000hours<br>Set for 24hours at room temperature, then measured              | Meet Table A after testing.<br>If the rated current of parts exceed 1A, the operating temperature should be 85 deg C.   |            |           |                              |             |               |              |
| 9                            | External Visual                 | Visual inspection  | No abnormalities  |            |           |                              |             |               |              |
| 10                           | Physical Dimension              | Meet ITEM 4<br>(Style and Dimensions)  | No defects  |            |           |                              |             |               |              |
| 12                           | Resistance to Solvents          | Per MIL-STD-202 Method 215   | Not Applicable  |            |           |                              |             |               |              |
| 13                           | Mechanical Shock                | Per MIL-STD-202 Method 213<br>Condition F:<br>1500g's(14.7N)/0.5ms/Half sine                 | Meet Table A after testing.   |            |           |                              |             |               |              |
| 14                           | Vibration                       | 5g's(0.049N) for 20 minutes<br>12cycles each of 3 orientations<br>Test from 10-2000Hz.       | Meet Table A after testing.   |            |           |                              |             |               |              |
| 15                           | Resistance to Soldering Heat    | Solder temperature 260C+/-5 deg C<br>Immersion time 10s                                      | Pre-heating: 150C +/-10 deg C, 60s to 90s<br><br>Meet Table A after testing.  |            |           |                              |             |               |              |
| 17                           | ESD                             | Per AEC-Q200-002   | Meet Table A after testing.<br>ESD Rank: Meet Item 3. (Rating)  |            |           |                              |             |               |              |
| 18                           | Solderability                   | Per J-STD-002  | Method b : Not Applicable<br>95% of the terminations is to be soldered.   |            |           |                              |             |               |              |
| 19                           | Electrical Characterization     | Measured : Impedance   | No defects  |            |           |                              |             |               |              |
| 20                           | Flammability                    | Per UL-94  | Not Applicable  |            |           |                              |             |               |              |
| 21                           | Board Flex                      | Epoxy-PCB(1.0mm)<br>Deflection 2mm(min)<br>60s minimum holding time                          | Meet Table A after testing.   |            |           |                              |             |               |              |
| 22                           | Terminal Strength               | Per AEC-Q200-006   | Murata deviation request: 5N<br>No defects  |            |           |                              |             |               |              |
| 30                           | Electrical Transient Conduction | Per ISO-7637-2   | Not Applicable  |            |           |                              |             |               |              |

## 7.Specification of Packaging

### 7-1.Appearance and Dimensions (8mm-wide paper tape)

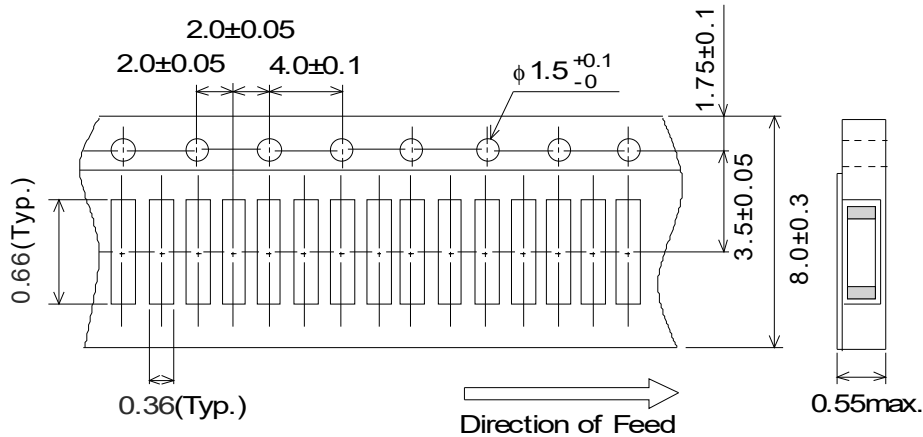

(1) Taping

Products shall be packaged in the cavity of the base tape of 8mm-wide, 2mm-pitch continuously and sealed by top tape and bottom tape.

(2) Sprocket hole: The sprocket holes are to the right as the tape is pulled toward the user.

(3) Spliced point: The base tape and top tape have no spliced point

(4) Cavity: There shall not be burr in the cavity.

(5) Missing components number

Missing components number within 0.025% of the number per reel or 1 pc., whichever is greater, and are not continuous. The specified quantity per reel is kept.

### 7-2.Tape Strength

(1) Pull Strength

|            |         |
|------------|---------|
| Cover tape | 5N min. |
|------------|---------|

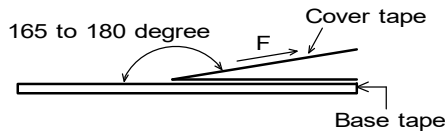

(2) Peeling off force of Cover tape

0.1N to 0.6N (Minimum value is typical.)

\*Speed of Peeling off: 300mm/min

### 7-3.Taping Condition

(1) Standard quantity per reel

|                         |                   |
|-------------------------|-------------------|
| Quantity per 180mm reel | 10000 pcs. / reel |
|-------------------------|-------------------|

(2) There shall be leader-tape(top tape and empty tape) and trailer-tape(empty tape) as follows.

(3) On paper tape, the top tape and the base tape shall not be adhered at the tip of the empty leader tape for more than 5 pitch.

(4) Marking for reel

The following items shall be marked on a label and the label is stuck on the reel.

(Customer part number, MURATA part number, Inspection number(\*1) , RoHS marking(\*2) , Quantity, etc)

\*1) « Expression of Inspection No. »  $\square\square$   $0000$   $\times\times\times$   
 (1) (2) (3)

(1) Factory Code

(2) Date

First digit : Year / Last digit of year

Second digit : Month / Jan. to Sep. → 1 to 9, Oct. to Dec. → O,N,D

Third, Fourth digit : Day

(3) Serial No.

\*2) « Expression of RoHS marking » ROHS - Y ( $\Delta$ )  
 (1) (2)

(1) RoHS regulation conformity parts.

(2) MURATA classification number

(5) Outside package

These reels shall be packed in the corrugated cardboard package and the following items shall be marked on a label and the label is stuck on the box.

(Customer name, Purchasing order number, Customer part number, MURATA part number,

RoHS marking(\*2) ,Quantity, etc)

(6)Dimensions of reel and taping(leader-tape, trailer-tape)

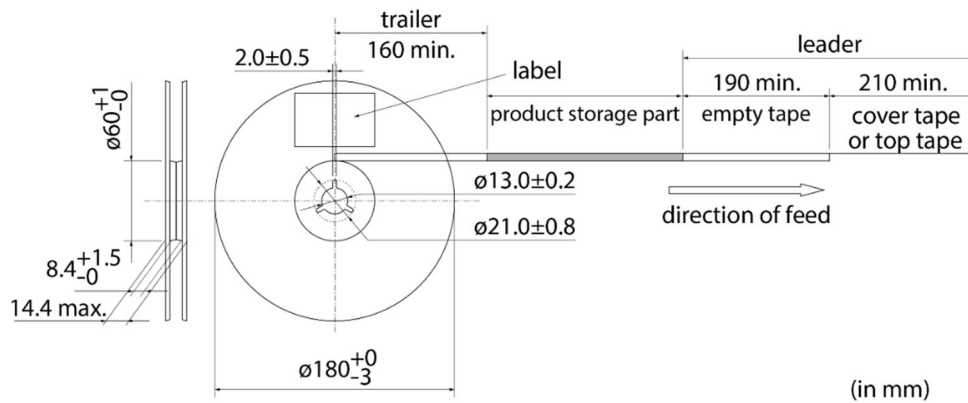

### 7-4. Specification of Outer Case

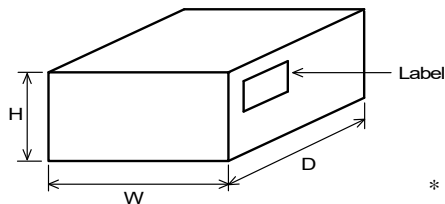

| Outer Case Dimensions (mm) |     |    | Standard Reel Quantity in Outer Case (Reel) |
|----------------------------|-----|----|---|
| W                          | D   | H  |   |
| 186                        | 186 | 93 | 5   |

\* Above Outer Case size is typical. It is depend on a quantity of an order.

## 8. ⚠ Caution

### 8-1.Rating

Do not use products beyond the Operating Temperature Range and Rated Current.

### 8-2.Surge current

Excessive surge current (pulse current or rush current) than specified rated current applied to the product may cause a critical failure, such as an open circuit, burnout caused by excessive temperature rise. Please contact us in advance in case of applying the surge current.

### 8-3.Fail Safe

Be sure to provide an appropriate fail-safe function on your product to prevent from a second damage that may be caused by the abnormal function or the failure of our products.

### 8-4.Limitation of Applications

Please contact us before using our products for the applications listed below which require especially high reliability for the prevention of defects which might directly cause damage to the third party's life, body or property.

- |                                  |   |
|----------------------------------|---|
| (1)Aircraft equipment            | (6)Disaster prevention / crime prevention equipment   |
| (2)Aerospace equipment           | (7)Traffic signal equipment   |
| (3)Undersea equipment            | (8)Transportation equipment (trains,ships,etc.)   |
| (4)Power plant control equipment | (9) Data-processing equipment   |
| (5)Medical equipment             | (10)Applications of similar complexity and /or reliability requirements to the applications listed in the above |

### 8-5. Corrosive gas

Please refrain from use since contact with environments with corrosive gases (sulfur gas [hydrogen sulfide, sulfur dioxide, etc.], chlorine, ammonia, etc.) or oils (cutting oil, silicone oil, etc.) that have come into contact with the previously stated corrosive gas environment will result in deterioration of product quality or an open from deterioration due to corrosion of product electrode, etc. We will not bear any responsibility for use under these environments.

## 9. Notice

This product is designed for solder mounting.

Please consult us in advance for applying other mounting method such as conductive adhesive.

### 9-1.Land pattern designing

- Standard land dimensions (Reflow soldering)

< For BLM03 series (except BLM03PG, BLM03PX, BLM03AX type) >

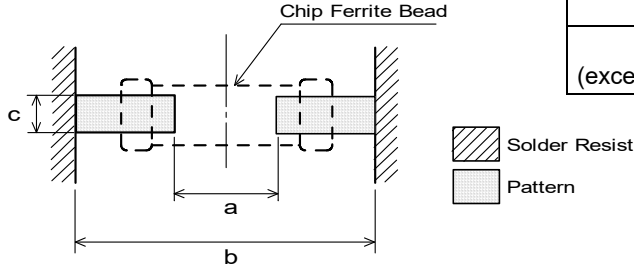

| Type                                | a    | b    | c    |
|-------------------------------------|------|------|------|
| BLM03<br>(except 03PG, PX, AX Type) | 0.25 | 0.80 | 0.30 |

(in mm)

< For BLM03PG, BLM03PX, BLM03AX type >

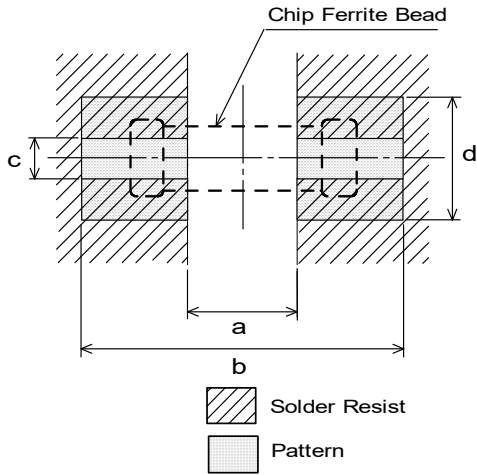

| Rated Current (A) | a    | b    | c    | Land pad thickness and dimension d |      |      |
|-------------------|------|------|------|------------------------------------|------|------|
|                   |      |      |      | 18μm                               | 35μm | 70μm |
| max.0.9           | 0.25 | 0.80 | 0.30 | 0.3                                | 0.3  | 0.3  |
| max.1.8           |      |      |      | 1.2                                | 0.7  | 0.3  |

(in mm)

\*The excessive heat by land pads may cause deterioration at joint of products with substrate.

## 9-2.Soldering Conditions

Products can be applied to reflow soldering.

### (1) Flux,Solder

|        |  |
|--------|--|
| Flux   | Use rosin-based flux, but not highly acidic flux (with chlorine content exceeding 0.2(wt)% . )<br>Do not use water-soluble flux. |
| Solder | Use Sn-3.0Ag-0.5Cu solder<br>Standard thickness of solder paste : 100 μm to 150 μm   |

### (2) Soldering conditions

- Pre-heating should be in such a way that the temperature difference between solder and ferrite surface is limited to 150°C max. Also cooling into solvent after soldering should be in such a way that the temperature difference is limited to 100°C max.

Insufficient pre-heating may cause cracks on the ferrite, resulting in the deterioration of product quality.

- Standard soldering profile and the limit soldering profile is as follows.

The excessive limit soldering conditions may cause leaching of the electrode and / or resulting in the deterioration of product quality.

### (3) Soldering profile

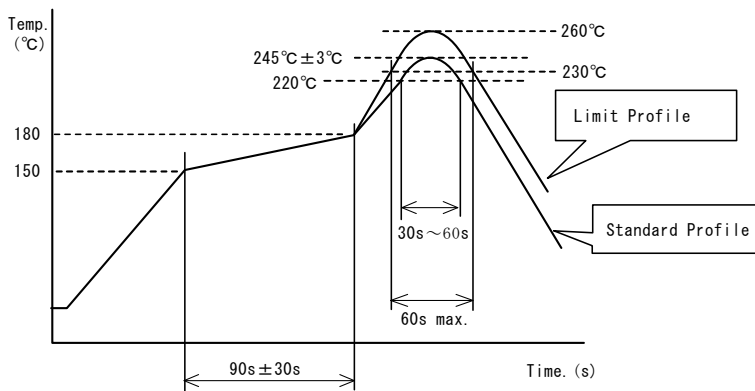

|                  | Standard Profile     | Limit Profile         |
|------------------|----------------------|-----------------------|
| Pre-heating      | 150~180°C 、 90s±30s  |                       |
| Heating          | above 220°C、 30s~60s | above 230°C、 60s max. |
| Peak temperature | 245±3°C              | 260°C,10s             |
| Cycle of reflow  | 2 times              | 2 times               |

## 9-3. Soldering iron

- Pre-heating: 150°C, 1 min
- Tip temperature: 350°C max.
- Soldering time : 3(+1,-0) seconds.
- Soldering iron output: 80W max.
- Tip diameter: φ 3mm max.
- Times : 2times max.

Note :Do not directly touch the products with the tip of the soldering iron in order to prevent the crack on the ferrite material due to the thermal shock.

## 9-4.Solder Volume

Solder shall be used not to be exceeded as shown below.

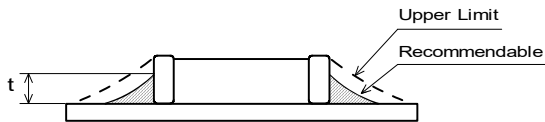

$$1/3T \leq t \leq T$$

(T:Chip thickness)

Accordingly increasing the solder volume, the mechanical stress to product is also increased. Exceeding solder volume may cause the failure of mechanical or electrical performance.

### 9-5.Attention regarding P.C.B. bending

The following shall be considered when designing and laying out P.C.B.'s.

- (1) P.C.B. shall be designed so that products are not subject to the mechanical stress for board warpage.  
 <Products direction>

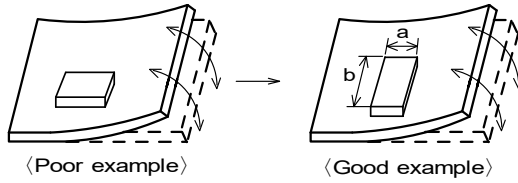

Products shall be located in the sideways direction (Length:a<b) to the mechanical stress.

- (2)Components location on P.C.B. separation.

It is effective to implement the following measures, to reduce stress in separating the board.

It is best to implement all of the following three measures; however, implement as many measures as possible to reduce stress.

| Contents of Measures   | Stress Level |
|--|--------------|
| (1) Turn the mounting direction of the component parallel to the board separation surface. | A > D *1     |
| (2) Add slits in the board separation part.  | A > B        |
| (3) Keep the mounting position of the component away from the board separation surface.    | A > C        |

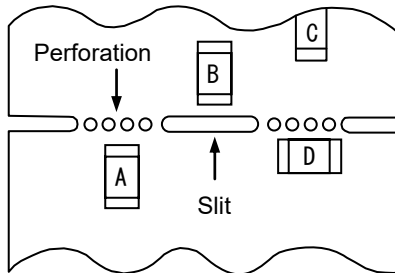

\*1 A > D is valid when stress is added vertically to the perforation as with Hand Separation.  
 If a Cutting Disc is used, stress will be diagonal to the PCB, therefore A > D is invalid.

- (3) Mounting Components Near Screw Holes

When a component is mounted near a screw hole, it may be affected by the board deflection that occurs during the tightening of the screw. Mount the component in a position as far away from the screw holes as possible.

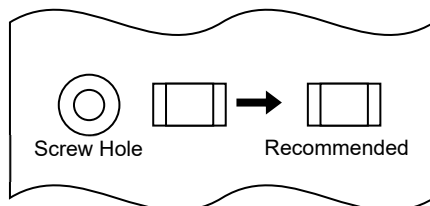

### 9-6.Mounting density

Add special attention to radiating heat of products when mounting the inductor near the products with heating.  
 The excessive heat by other products may cause deterioration at joint of this product with substrate.

### 9-7. Operating Environment

Do not use this product under the following environmental conditions, on deterioration of the Insulation Resistance of the Ferrite material and/or corrosion of Inner Electrode may result from the use.

- (1) in the corrodible atmosphere such as acidic gases, alkaline gases, chlorine, sulfur gases, organic gases and etc.  
 (the sea breeze, Cl<sub>2</sub>, H<sub>2</sub>S, NH<sub>3</sub>, SO<sub>2</sub>, NO<sub>2</sub>,etc)
- (2) in the atmosphere where liquid such as organic solvent, may splash on the products.
- (3) in the atmosphere where the temperature / humidity changes rapidly and it is easy to dew.