

CHIP FERRITE BEAD BLM15□□□□SH1□
Murata Standard Reference Specification [AEC-Q200]

1. Scope

This reference specification applies to chip ferrite bead BLM15_SH series for automotive electronics based on AEC-Q200.

2. Part Numbering

(Ex.)

BL	M	15	AG	102	S	H	1	D
Product ID	Type	Dimension (L × W)	Characteristics	Impedance (Typical value at 100 MHz)	Performance	Category (For automotive)	Numbers of circuit	Packaging (D: taping)

3. Part Number and Rating

Operating temperature range	-55°C to +125°C
Storage temperature range	-55°C to +125°C

Customer Part number	Murata Part number	Impedance (Ω) at 100 MHz	Rated current*1 (mA)		DC resistance (Ω) max.		Remark	ESD rank 2: 2 kV 5A:8 kV
			Ambient temperature 85°C	Ambient temperature 125°C	Initial values	Values after testing		
	BLM15AG100SH1D	5 to 15	-	1000	0.05	0.10	For general use	2
	BLM15AG700SH1D	40 to 100	-	500	0.15	0.20	For general use	2
	BLM15AG121SH1D	120±25%	-	500	0.25	0.35	For general use	2
	BLM15AG221SH1D	220±25%	-	300	0.35	0.45	For general use	2
	BLM15AG601SH1D	600±25%	-	300	0.6	0.70	For general use	2
	BLM15AG102SH1D	1000±25%	-	200	1.0	1.1	For general use	2
	BLM15BB050SH1D	5±25%	-	500	0.08	0.15	For high speed signal line	2
	BLM15BB100SH1D	10±25%	-	300	0.10	0.15	For high speed signal line	2
	BLM15BB220SH1D	22±25%	-	300	0.20	0.30	For high speed signal line	2
	BLM15BB470SH1D	47±25%	-	300	0.35	0.45	For high speed signal line	2
	BLM15BB750SH1D	75±25%	-	300	0.40	0.50	For high speed signal line	2
	BLM15BB121SH1D	120±25%	-	300	0.55	0.65	For high speed signal line	2
	BLM15BB221SH1D	220±25%	-	200	0.80	0.90	For high speed signal line	2
	BLM15BD471SH1D	470±25%	-	200	0.60	0.70	For high speed signal line	2
	BLM15BD601SH1D	600±25%	-	200	0.65	0.75	For high speed signal line	2
	BLM15BD102SH1D	1000±25%	-	200	0.90	1.0	For high speed signal line	2
	BLM15BD182SH1D	1800±25%	-	200	1.4	1.5	For high speed signal line	2
	BLM15PE300SH1D	30±25%	2300	1400	0.035	0.050	For DC power line	5A
	BLM15PE600SH1D	60±25%	1800	1100	0.060	0.075	For DC power line	5A
	BLM15PE800SH1D	80±25%	1700	1000	0.070	0.085	For DC power line	5A
	BLM15PE121SH1D	120±25%	1500	900	0.090	0.105	For DC power line	5A
	BLM15PE181SH1D	180±25%	1200	700	0.140	0.155	For DC power line	5A
	BLM15PE221SH1D	220±25%	1100	650	0.17	0.19	For DC power line	5A
	BLM15PE331SH1D	330±25%	1000	580	0.21	0.23	For DC power line	5A
	BLM15PE471SH1D	470±25%	750	450	0.35	0.37	For DC power line	5A
	BLM15PE601SH1D	600±25%	700	420	0.40	0.42	For DC power line	5A
	BLM15PX330SH1D	33±25%	3000	1700	0.022	0.037	For DC power line	5A
	BLM15PX600SH1D	60±25%	2500	1400	0.032	0.047	For DC power line	5A
	BLM15PX800SH1D	80±25%	2300	1300	0.038	0.053	For DC power line	5A

Customer Part number	Murata Part number	Impedance (Ω) at 100 MHz	Rated current*1 (mA)		DC resistance (Ω) max.		Remark	ESD rank 2: 2 kV 5A:8 kV
			Ambient temperature 85°C	Ambient temperature 125°C	Initial values	Values after testing		
	BLM15PX121SH1D	120±25%	2000	1100	0.055	0.070	For DC power line	5A
	BLM15PX181SH1D	180±25%	1500	800	0.090	0.105	For DC power line	5A
	BLM15PX221SH1D	220±25%	1400	800	0.100	0.115	For DC power line	5A
	BLM15PX331SH1D	330±25%	1200	700	0.150	0.165	For DC power line	5A
	BLM15PX471SH1D	470±25%	1000	600	0.200	0.220	For DC power line	5A
	BLM15PX601SH1D	600±25%	900	500	0.230	0.250	For DC power line	5A

*1 In case of BLM15PE series and BLM15PX series, as shown in the diagram below, derating is applied to the rated current based on the operating temperature.

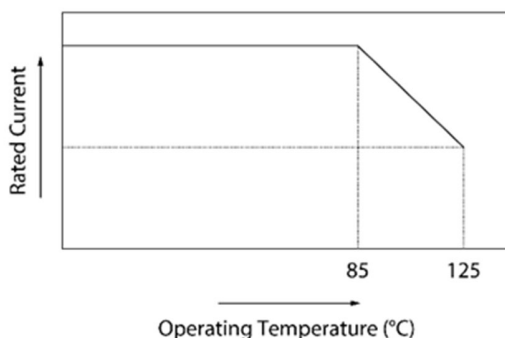

4. Testing Conditions

Unless otherwise specified	Temperature: ordinary temperature (15°C to 35°C) Humidity: ordinary humidity [25% to 85% (RH)]
In case of doubt	Temperature: 20°C±2°C Humidity: 60% to 70% (RH) Atmospheric pressure: 86 kPa to 106 kPa

5. Appearance and Dimensions

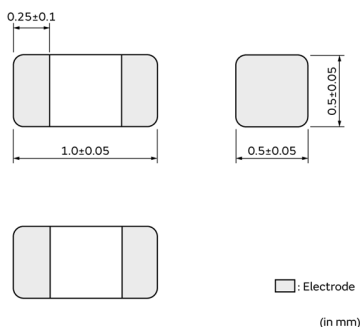

Equivalent circuit

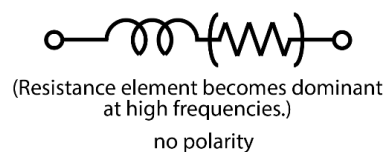

Unit mass (typical value): 0.001 g

6. Marking

No marking.

7. Electrical Performance

No.	Item	Specification	Test method
7.1	Impedance	Meet chapter 3 ratings.	Measuring equipment: Keysight 4291A or the equivalent Measuring frequency: 100 MHz±1 MHz Measuring fixture: Keysight 16192A or the equivalent
7.2	DC resistance	Meet chapter 3 ratings.	Measuring equipment: digital multimeter Substrate wiring resistance is excluded.

8. AEC-Q200 Requirement**8.1 Performance [(based on table 13 for filter EMI suppressors/filters) AEC-Q200 Rev.D issued June 1, 2010]**

AEC-Q200			Murata specification/deviation						
No.	Stress	Test method							
3	High temperature exposure	1000 h at 125°C Set for 24 h at room condition, then measured.	Meet table A after testing. Table A <table border="1"> <tr> <td>Appearance</td> <td>No damage</td> </tr> <tr> <td>Impedance change (at 100 MHz)</td> <td>Within ±30%</td> </tr> <tr> <td>DC Resistance</td> <td>Meet chapter 3 ratings.</td> </tr> </table>	Appearance	No damage	Impedance change (at 100 MHz)	Within ±30%	DC Resistance	Meet chapter 3 ratings.
Appearance	No damage								
Impedance change (at 100 MHz)	Within ±30%								
DC Resistance	Meet chapter 3 ratings.								
4	Temperature cycling	1000 cycles -55°C to +125°C Set for 24 h at room condition, then measured.	Meet table B after testing. Table B <table border="1"> <tr> <td>Appearance</td> <td>No damage</td> </tr> <tr> <td>Impedance change (at 100 MHz)</td> <td>Within ±30% (BLM15PE: within±60%) (BLM15PX: within±50%)</td> </tr> <tr> <td>DC Resistance</td> <td>Meet chapter 3 ratings.</td> </tr> </table>	Appearance	No damage	Impedance change (at 100 MHz)	Within ±30% (BLM15PE: within±60%) (BLM15PX: within±50%)	DC Resistance	Meet chapter 3 ratings.
Appearance	No damage								
Impedance change (at 100 MHz)	Within ±30% (BLM15PE: within±60%) (BLM15PX: within±50%)								
DC Resistance	Meet chapter 3 ratings.								
5	Destructive physical analysis	Per EIA469 No electrical tests	No defects						
7	Biased humidity	1000 h at 85°C, 85% (RH). Apply max rated current. Set for 24 h at room condition, then measured.	Meet table B after testing.						
8	Operational life	Apply 125°C 1000 h Set for 24 h at room condition, then measured.	Meet table B after testing.						
9	External visual	Visual inspection	No abnormalities						
10	Physical dimension	Meet chapter 5, "Appearance and Dimensions".	No defects						
12	Resistance to solvents	Per MIL-STD-202 Method 215	Not applicable						
13	Mechanical shock	Per MIL-STD-202 Method 213 Condition F: 1500 g's (14.7 N), 0.5 ms, half sine	Meet table A after testing.						
14	Vibration	5 g's (0.049 N) for 20 min, 12 cycles each of 3 orientations Test from 10 Hz to 2000 Hz	Meet table A after testing.						
15	Resistance to soldering heat	Solder temperature 260°C±5°C Immersion time 10 s	Pre-heating: 150°C±10°C, 60 s to 90 s Meet table C after testing. Table C <table border="1"> <tr> <td>Appearance</td> <td>No damage</td> </tr> <tr> <td>Impedance change (at 100 MHz)</td> <td>Within ±30% (BLM15PE: within±50%)</td> </tr> <tr> <td>DC Resistance</td> <td>Meet chapter 3 ratings.</td> </tr> </table>	Appearance	No damage	Impedance change (at 100 MHz)	Within ±30% (BLM15PE: within±50%)	DC Resistance	Meet chapter 3 ratings.
Appearance	No damage								
Impedance change (at 100 MHz)	Within ±30% (BLM15PE: within±50%)								
DC Resistance	Meet chapter 3 ratings.								
17	ESD	Per AEC-Q200-002	ESD rank: Refer to chapter 3 ratings. Meet table D after testing. Table D <table border="1"> <tr> <td>Appearance</td> <td>No damage</td> </tr> <tr> <td>Impedance change (at 100 MHz)</td> <td>Within ±30% (BLM15BB/BD: within ±40%) (BLM15PE: within±50%)</td> </tr> <tr> <td>DC Resistance</td> <td>Meet chapter 3 ratings.</td> </tr> </table>	Appearance	No damage	Impedance change (at 100 MHz)	Within ±30% (BLM15BB/BD: within ±40%) (BLM15PE: within±50%)	DC Resistance	Meet chapter 3 ratings.
Appearance	No damage								
Impedance change (at 100 MHz)	Within ±30% (BLM15BB/BD: within ±40%) (BLM15PE: within±50%)								
DC Resistance	Meet chapter 3 ratings.								
18	Solderability	Per J-STD-002	Method b: not applicable 95% of the terminations is to be soldered.						

AEC-Q200			Murata specification/deviation
No.	Stress	Test method	
19	Electrical characterization	Measured: impedance	No defects
20	Flammability	Per UL-94	Not applicable
21	Board flex	Epoxy-PCB (1.6 mm) Deflection 2 mm (min.) Holding time 60 s	Meet table A after testing.
22	Terminal strength	Per AEC-Q200-006	Murata deviation request: 5 N No defects
30	Electrical transient conduction	Per ISO-7637-2	Not applicable

9. Specification of Packaging

9.1 Appearance and dimensions of tape (8 mm width/paper tape)

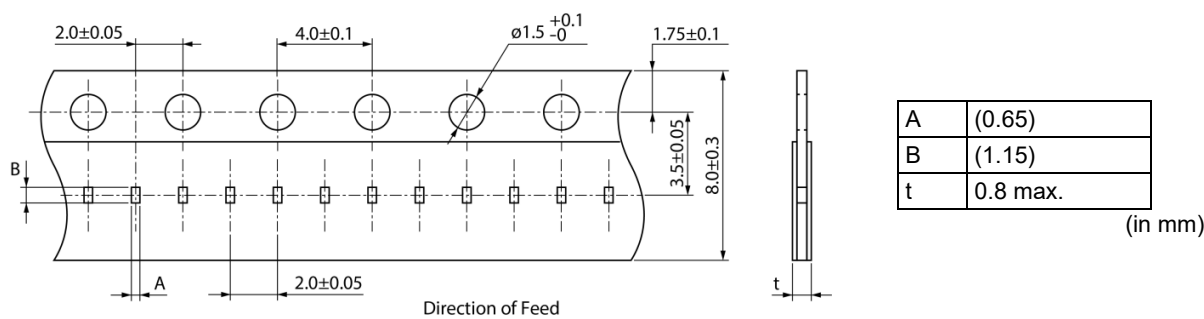

9.2 Taping specifications

Packing quantity (Standard quantity)	10000 pcs/reel
Packing method	The products are placed in cavities of a carrier tape and sealed by a cover tape (top tape and bottom tape when the cavities of the carrier tape are punched type).
Feed hole position	The feed holes on the carrier tape are on the right side when the cover tape (top tape when the cavities of the carrier tape are punched type) is pulled toward the user.
Joint	The carrier tape and cover tape (top tape when the cavities of the carrier tape are punched type) are seamless.
Number of missing products	Number of missing products within 0.025% of the number per reel or 1 pc., whichever is greater, and are not continuous. The specified quantity per reel is kept.

9.3 Break down force of tape

Cover tape (or top tape)	5 N min.
Bottom tape (only when the cavities of the carrier tape are punched type)	5 N min.

9.4 Peeling off force of tape

Speed of peeling off	300 mm/min
Peeling off force	0.1 N to 0.6 N (The lower limit is for typical value.)

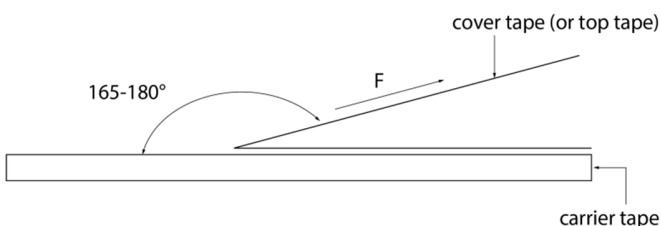

9.5 Dimensions of leader section, trailer section and reel

A vacant section is provided in the leader (start) section and trailer (end) section of the tape for the product. The leader section is further provided with an area consisting only of the cover tape (or top tape). (See the diagram below.)

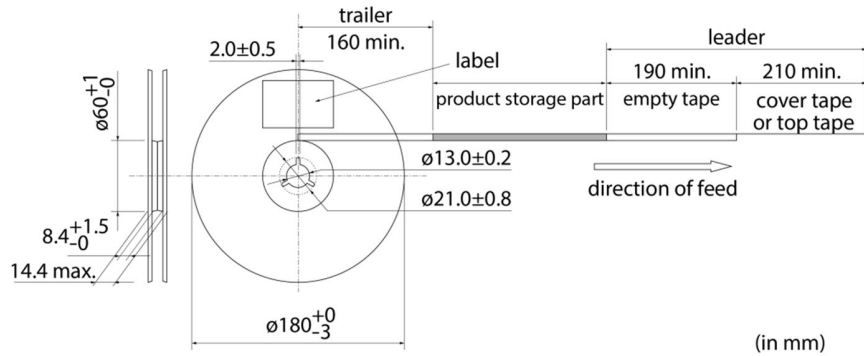

9.6 Marking for reel

Customer part number, Murata part number, inspection number (*1), RoHS marking (*2), quantity, etc.

*1 Expression of inspection No.: $\frac{\square\square}{(1)} \quad \frac{\circ\circ\circ\circ}{(2)} \quad \frac{\diamond\diamond\diamond}{(3)}$	(1) Factory code (2) Date First digit: year/last digit of year Second digit: month/Jan. to Sep.→1 to 9, Oct. to Dec.→O, N, D Third, Fourth digit: day (3) Serial No.
*2 Expression of RoHS marking: ROHS- $\frac{Y}{(1)} \quad \frac{(\Delta)}{(2)}$	(1) RoHS regulation conformity (2) Murata classification number

9.7 Marking on outer box (corrugated box)

Customer name, purchasing order number, customer part number, Murata part number, RoHS marking (*2), quantity, etc.

9.8 Specification of outer box

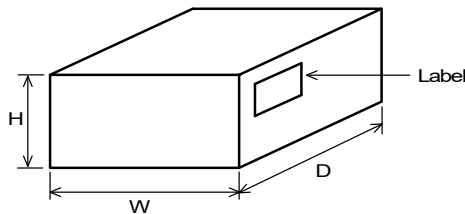

Dimensions of outer box (mm)			Standard reel quantity in outer box (reel)
W	D	H	
186	186	93	5
* Above outer box size is typical. It depends on a quantity of an order.			

10. ⚠Caution

10.1 Restricted applications

Please contact us before using our products for the applications listed below which require especially high reliability for the prevention of defects which might directly cause damage to the third party's life, body or property.

- | | | | |
|-------------------------------|---|------------------------------|---|
| (1) Aircraft equipment | (2) Aerospace equipment | (3) Undersea equipment | (4) Power plant control equipment |
| (5) Medical equipment | (6) Transportation equipment (trains, ships, etc.) | (7) Traffic signal equipment | (8) Disaster/crime prevention equipment |
| (9) Data-processing equipment | (10) Applications of similar complexity and/or reliability requirements to the applications listed in the above | | |

10.2 Precautions on rating

Avoid using in exceeded the rated temperature range, rated voltage, or rated current. Usage when the ratings are exceeded could lead to wire breakage, burning, or other serious fault.

10.3 Fail-safe

Be sure to provide an appropriate fail-safe function on your product to prevent a second damage that may be caused by the abnormal function or the failure of our product.

10.4 Inrush current

If an inrush current (or pulse current or rush current) that significantly exceeds the rated current is applied to the product, overheating could occur, resulting in wire breakage, burning, or other serious fault.

10.5 Corrosive gas

Please refrain from use since contact with environments with corrosive gases (sulfur gas [hydrogen sulfide, sulfur dioxide, etc.], chlorine, ammonia, etc.) or oils (cutting oil, silicone oil, etc.) that have come into contact with the previously stated corrosive gas environment will result in deterioration of product quality or an open from deterioration due to corrosion of product electrode, etc. We will not bear any responsibility for use under these environments.

11. Precautions for Use

This product is for use only with reflow soldering. It is designed to be mounted by soldering. If you want to use other mounting method, for example, using a conductive adhesive, please consult us beforehand. Also, if repeatedly subjected to temperature cycles or other thermal stress, due to the difference in the coefficient of thermal expansion with the mounting substrate, the solder (solder fillet part) in the mounting part may crack. The occurrence of cracks due to thermal stress is affected by the size of the land where mounted, the solder volume, and the heat dissipation of the mounting substrate. Carefully design it when a large change in ambient temperature is assumed.

11.1 Land dimensions

The following diagram shows the recommended land dimensions for reflow soldering:

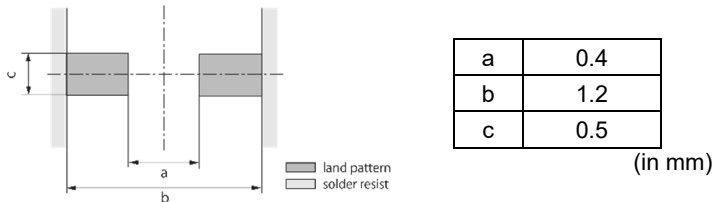
**11.2 Flux and solder used**

Flux	<ul style="list-style-type: none"> • Use a rosin-based flux. • Do not use a highly acidic flux with a halide content exceeding 0.2(wt)% (chlorine conversion value). • Do not use a water-soluble flux.
Solder	<ul style="list-style-type: none"> • Use Sn-3.0Ag-0.5Cu solder. • Standard thickness of solder paste: 100 μm to 200 μm

If you want to use a flux other than the above, please consult our technical department.

11.3 Soldering conditions (reflow)

- Pre-heating should be in such a way that the temperature difference between solder and product surface is limited to 150°C max.
Cooling into solvent after soldering also should be in such a way that the temperature difference is limited to 100°C max. Insufficient pre-heating may cause cracks on the product, resulting in the deterioration of product quality.
- Standard soldering profile and the limit soldering profile is as follows.
The excessive limit soldering conditions may cause leaching of the electrode and/or resulting in the deterioration of product quality.

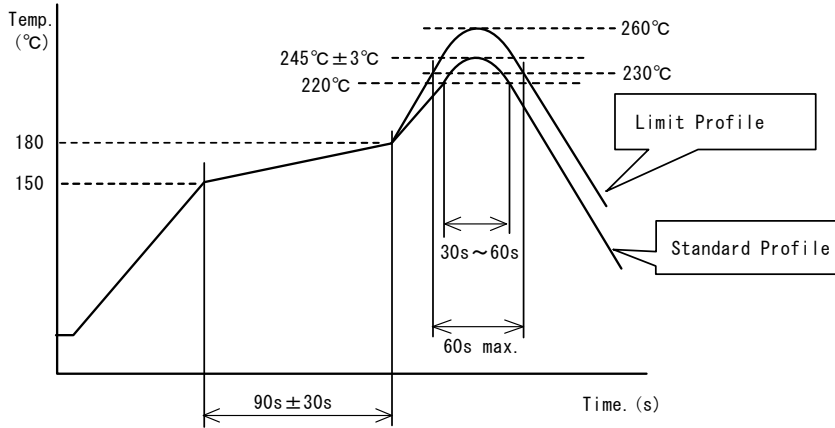

	Standard profile	Limit profile
Pre-heating	150°C to 180°C/90 s ± 30 s	150°C to 180°C/90 s ± 30 s
Heating	Above 220°C/30 s to 60 s	Above 230°C/60 s max.
Peak temperature	245°C ± 3°C	260°C/10 s
Number of reflow cycles	2 times	2 times

11.4 Reworking with soldering iron

The following requirements must be met to rework a soldered product using a soldering iron.

Item	Requirement
Pre-heating	150°C/approx. 1 min
Tip temperature of soldering iron	350°C max.
Power consumption of soldering iron	80 W max.
Tip diameter of soldering iron	ø3 mm max.
Soldering time	3 s (+1 s, -0 s)
Number of reworking operations	2 times max.
* Avoid a direct contact of the tip of the soldering iron with the product. Such a direction contact may cause cracks in the ceramic body due to thermal shock.	

11.5 Solder volume

Solder shall be used not to be exceeded the upper limits as shown below.

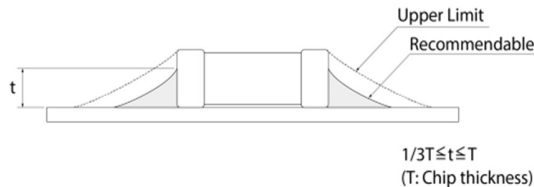

An increased solder volume increases mechanical stress on the product. Exceeding solder volume may cause the failure of mechanical or electrical performance.

11.6 Product's location

The following shall be considered when designing and laying out PCBs.

(1) PCB shall be designed so that products are not subject to mechanical stress due to warping the board.

[Products direction]

Products shall be located in the sideways direction (length: $a < b$) to the mechanical stress.

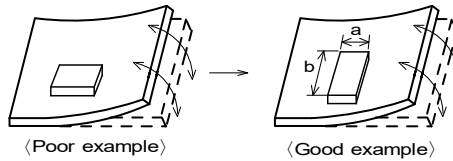

(2) Components location on PCB separation

It is effective to implement the following measures, to reduce stress in separating the board.

It is best to implement all of the following three measures; however, implement as many measures as possible to reduce stress.

Contents of measures	Stress level
(1) Turn the mounting direction of the component parallel to the board separation surface.	$A > D^*1$
(2) Add slits in the board separation part.	$A > B$
(3) Keep the mounting position of the component away from the board separation surface.	$A > C$
*1 $A > D$ is valid when stress is added vertically to the perforation as with hand separation. If a cutting disc is used, stress will be diagonal to the PCB, therefore $A > D$ is invalid.	

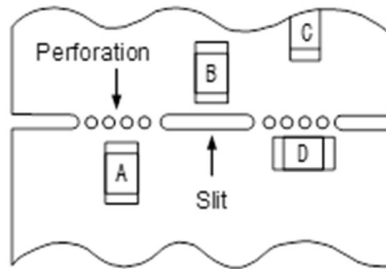

(3) Mounting components near screw holes

When a component is mounted near a screw hole, it may be affected by the board deflection that occurs during the tightening of the screw.

Mount the component in a position as far away from the screw holes as possible.

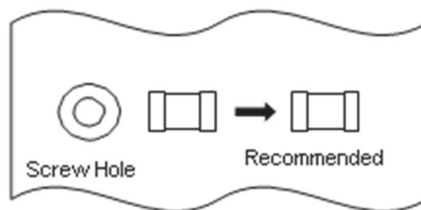

11.7 Handling of substrate

After mounting products on a substrate, do not apply any stress to the product caused by bending or twisting to the substrate when cropping the substrate, inserting and removing a connector from the substrate or tightening screw to the substrate. Excessive mechanical stress may cause cracking in the product.

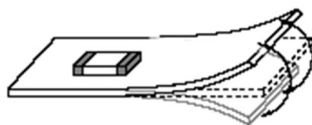

Bending

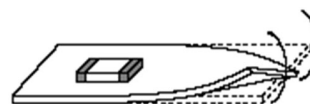

Twisting

11.8 Cleaning

When cleaning this product, observe the following conditions.

Any cleaning may cause deterioration in the quality of the product, so please check the quality of this product before use.

- (1) The cleaning temperature shall be 60°C max. If isopropyl alcohol (IPA) is used, the cleaning temperature shall be 40°C max.
- (2) When ultrasonic cleaning is used, under some cleaning conditions, the substrate could resonate and the substrate vibrations could result in chip cracks, solder breakage, and other problems. Be sure to always perform a test cleaning beforehand using an actual cleaning device, and then check the quality of the products.
- (3) Cleaner
Alcohol-based cleaner: IPA
Aqueous agent: PINE ALPHA ST-100S
- (4) There shall be no residual flux or residual cleaner.

When using aqueous agent, rinse the product with deionized water adequately and completely dry it so that no cleaner is left.

* For other cleaning, please consult our technical department.

11.9 Storage and transportation

Storage period	Use the product within 6 months after delivery. If you do not use the product for more than 6 months, check solderability before using it.
Storage conditions	<ul style="list-style-type: none"> • The products shall be stored in a room not subject to rapid changes in temperature and humidity. The recommended temperature range is -10°C to +40°C. The recommended relative humidity range is 15% to 85%. • Keeping the product in corrosive gases, such as sulfur, chlorine gas or acid may cause the poor solderability. • Do not place the products directly on the floor; they should be placed on a palette so that they are not affected by humidity or dust. • Avoid keeping the products in a place exposed to direct sunlight, heat or vibration. • Do not keep products in bulk packaging. Bulk storage could result in collisions between the products or between the products and other parts, resulting in chipping or wire breakage. • Avoid storing the product by itself bare (i.e. exposed directly to air).
Transportation	Excessive vibration and impact reduces the reliability of the products. Exercise caution when handling the products.

11.10 Resin coating (including moisture-proof coating)

When the product is coated/molded with resin, its electrical characteristics may change.

A wire breakage issue may occur by mechanical stress caused by the resin, amount/cured shape of resin, or operating condition etc.

Some resins contain impurities or hydrolyzable chlorine, which could result in corrosion of the conducting materials, leading to wire breakage.

So, please pay your careful attention when you select resin in case of coating/molding the products with the resin.

Prior to use the coating resin, please make sure no reliability issue is observed by evaluating products mounted on your board.

11.11 Mounting conditions

Check the mounting condition before using.

Using mounting conditions (nozzles, equipment conditions, etc.) that are not suitable for products may lead to pick up errors, misalignment, or damage to the product.

11.12 Operating environment

Do not use this product under the following environmental conditions as it may cause deterioration of product quality.

- (1) In the corrodible atmosphere such as acidic gases, alkaline gases, chlorine, sulfur gases, organic gases and etc. (the sea breeze, Cl₂, H₂S, NH₃, SO₂, NO₂, etc)
- (2) In the atmosphere where liquid such as organic solvent, may splash on the products.
- (3) In the atmosphere where the temperature/humidity changes rapidly and it is easy to dew.

11.13 Mounting density

If this product is placed near heat-generating products, be sure to implement sufficient heat-dissipating measures.

If this product is subjected to a significant amount of heat from other products, this could adversely affect product quality, resulting in a circuit malfunction or failure of the mounted section. Also, be sure that the product is used in a manner so that the heat that the product is subjected to from other products does not exceed the upper limit of the rated operating temperature for the product.