

## Chip Ferrite Bead BLM15PX□□□BH1□ Murata Standard Reference Specification [AEC-Q200]

### 1. Scope

This reference specification applies to chip ferrite bead BLM15PX□□□BH1□ series for automotive electronics based on AEC-Q200.

### 2. Part Numbering

(Ex.)

BL	M	15	PX	330	B	H	1	D
Product ID	Type	Dimension (L × W)	Application and characteristic	Impedance	Performance	Category H: for automotive electronics	Number of line	Packaging D: taping *B: bulk

\*B: Bulk packing is also available.

### 3. Part Number and Rating

Operating temperature range	-55°C to +150°C
Storage temperature range	-55°C to +150°C

Customer Part number	Murata Part number	Impedance (Ω) at 100 MHz	Rated current (mA)			DC resistance (Ω max.)		ESD rank
			Ambient temperature 85°C	Ambient temperature 125°C	Ambient temperature 150°C	Initial value	Value after testing	
	BLM15PX330BH1D	33±25%	3000	1700	10	0.022	0.037	5A
	BLM15PX600BH1D	60±25%	2500	1400	10	0.032	0.047	5A
	BLM15PX800BH1D	80±25%	2300	1300	10	0.038	0.053	5A
	BLM15PX121BH1D	120±25%	2000	1100	10	0.055	0.070	5A
	BLM15PX181BH1D	180±25%	1500	800	10	0.090	0.105	5A
	BLM15PX221BH1D	220±25%	1400	800	10	0.100	0.115	5A
	BLM15PX331BH1D	330±25%	1200	700	10	0.150	0.165	5A
	BLM15PX471BH1D	470±25%	1000	600	10	0.200	0.220	5A
	BLM15PX601BH1D	600±25%	900	500	10	0.230	0.250	5A

\* As shown in the diagram below, derating is applied to the rated current based on the operating temperature.

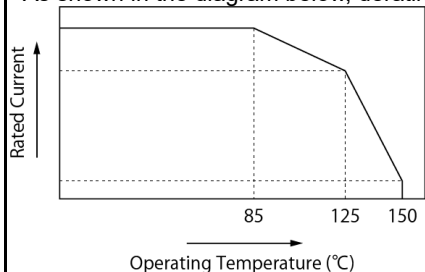

ESD Rank	Maximum Withstand Voltage
5A	8000 V (DC) to < 12,000 V (AD)

**4. Testing Conditions**

Unless otherwise specified	Temperature: ordinary temperature (15°C to 35°C) Humidity: ordinary humidity [25% to 85% (RH)]
In case of doubt	Temperature: 20°C±2°C Humidity: 60% to 70% (RH) Atmospheric pressure: 86 kPa to 106 kPa

**5. Appearance and Dimensions**

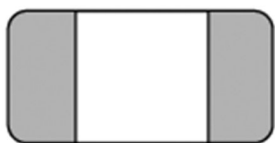
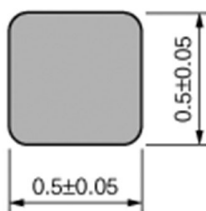
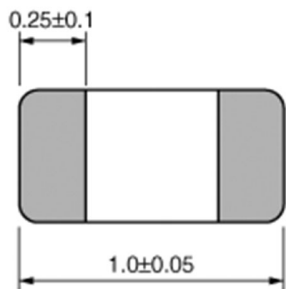

■: Electrode  
(in mm)

■ Equivalent Circuit

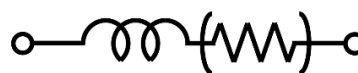

(Resistance element becomes dominant at high frequencies.)  
no polarity

Unit mass (typical value): 0.001g

**6. Marking**

No marking.

**7. Electrical Performance**

No.	Item	Specification	Test method
7.1	Impedance	Meet chapter 3 ratings.	Measuring equipment: Keysight 4291A or the equivalent Measuring frequency: 100 MHz Measuring fixture: Keysight 16192A, 16197A
7.2	DC resistance	Meet chapter 3 ratings.	Measuring equipment: digital multimeter Except resistance of the substrate and wire.

**8. Q200 Requirement**

Performance(based on Table 13 for FILTER EMI SUPPRESSORS/FILTERS)

AEC-Q200 Rev.D issued June 1, 2010

AEC-Q200			Murata Specification / Deviation
No.	Stress	Test Method	
3	High temperature exposure	1000 h at 150°C Set for 24 h at room condition, then measured.	Appearance: No damage Impedance change rate: within $\pm 30\%$ DC resistance: Meet chapter 3, "Part Number and Rating".
4	Temperature cycling	1000 cycles -55°C to +150°C Set for 24 h at room condition, then measured.	Appearance: No damage Impedance change rate: within $\pm 50\%$ DC resistance: Meet chapter 3, "Part Number and Rating".
5	Destructive physical analysis	Per EIA469 No electrical tests	No defects
7	Biased humidity	1000 h at 85°C, 85% (RH). Apply max rated voltage and rated current. Set for 24 h at room condition, then measured.	Apply max rated current. Appearance: No damage Impedance change rate: within $\pm 50\%$ DC resistance: Meet chapter 3, "Part Number and Rating".
8	Operational life	Apply 150°C 1000 h Set for 24 h at room condition, then measured.	Appearance: No damage Impedance change rate: within $\pm 50\%$ DC resistance: Meet chapter 3, "Part Number and Rating".
9	External visual	Visual inspection	No abnormalities
10	Physical dimension	Meet chapter 5, "Appearance and Dimensions".	No defects
12	Resistance to solvents	Per MIL-STD-202 Method 215	Not applicable
13	Mechanical shock	Per MIL-STD-202 Method 213 Condition F: 1500 g's/0.5 ms/half sine	Appearance: No damage Impedance change rate: within $\pm 30\%$ DC resistance: Meet chapter 3, "Part Number and Rating".
14	Vibration	5 g's for 20 min, 12 cycles each of 3 orientations Test from 10 Hz to 2000 Hz	Appearance: No damage Impedance change rate: within $\pm 30\%$
15	Resistance to Soldering Heat	No-heating Solder temperature 260°C $\pm$ 5°C Immersion time 10 s	Appearance: No damage Impedance change rate: within $\pm 30\%$ DC resistance: Meet chapter 3, "Part Number and Rating".  <u>Deviation for AEC-Q200</u> Pre-heating: 150°C/60s to 90s
17	ESD	Per AEC-Q200-002	ESD Rank: Refer to chapter 3, "Part Number and Rating". Appearance: No damage Impedance change rate: within $\pm 30\%$ DC resistance: Meet chapter 3, "Part Number and Rating".
18	Solderability	Per J-STD-002	95% or more of the outer electrode shall be covered with new solder seamlessly.  <u>Deviation for AEC-Q200</u> Method b: Not applicable Pre-heating: 150°C/60s

AEC-Q200			Murata Specification / Deviation
No.	Stress	Test Method	
19	Electrical Characterization	Measured: impedance	No defects
20	Flammability	Per UL-94	Not applicable
21	Board Flex	Epoxy-PCB (1.6 mm) Deflection 2 mm (min.) 60 s minimum holding time	Appearance: No damage Impedance change rate: within ±30%
22	Terminal Strength	Per AEC-Q200-006 A force of 17.7 N for 60 s	Appearance: No damage  <u>Deviation for AEC-Q200</u> Applying force: 5 N
30	Electrical characterization conduction	Per ISO-7637-2	Not applicable

**9. Specification of Packaging**

**9.1 Appearance and dimensions of tape (8 mm width/paper tape)**

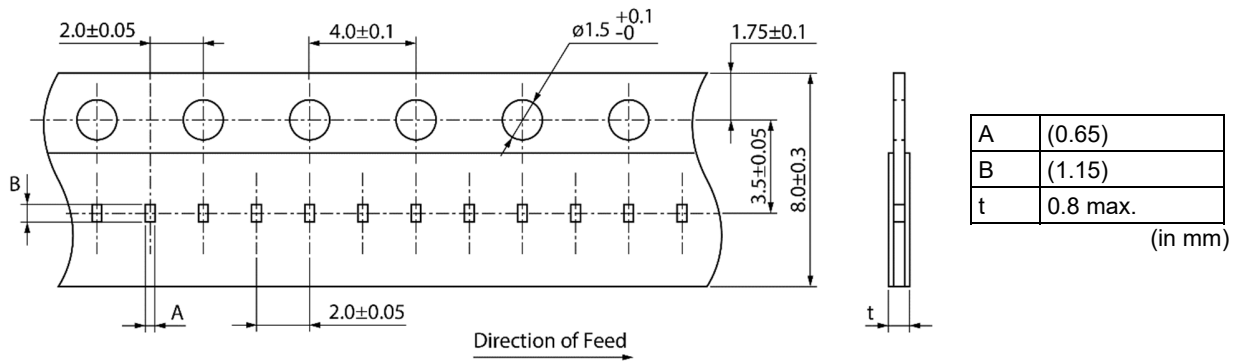

**9.2 Taping specifications**

Packing quantity (Standard quantity)	10000 pcs/reel
Packing method	The products are placed in cavities of a carrier tape and sealed by a cover tape (top tape and bottom tape when the cavities of the carrier tape are punched type).
Feed hole position	The feed holes on the carrier tape are on the right side when the cover tape (top tape when the cavities of the carrier tape are punched type) is pulled toward the user.
Joint	The carrier tape and cover tape (top tape when the cavities of the carrier tape are punched type) are seamless.
Number of missing products	Number of missing products within 0.025% of the number per reel or 1 pc., whichever is greater, and are not continuous. The specified quantity per reel is kept.

**9.3 Break down force of tape**

Cover tape (or top tape)	5 N min.
Bottom tape (only when the cavities of the carrier tape are punched type)	5 N min.

**9.4 Peeling off force of tape**

Speed of peeling off	300 mm/min
Peeling off force	0.1 N to 0.7 N (The lower limit is for typical value.)

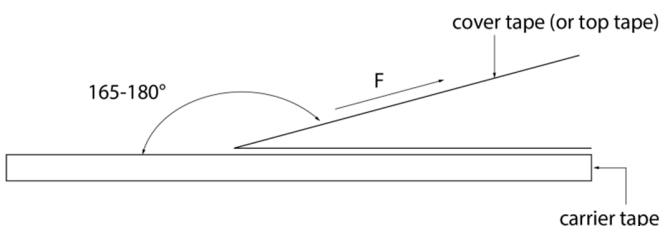

**9.5 Dimensions of leader section, trailer section and reel**

A vacant section is provided in the leader (start) section and trailer (end) section of the tape for the product. The leader section is further provided with an area consisting only of the cover tape (or top tape). (See the diagram below.)

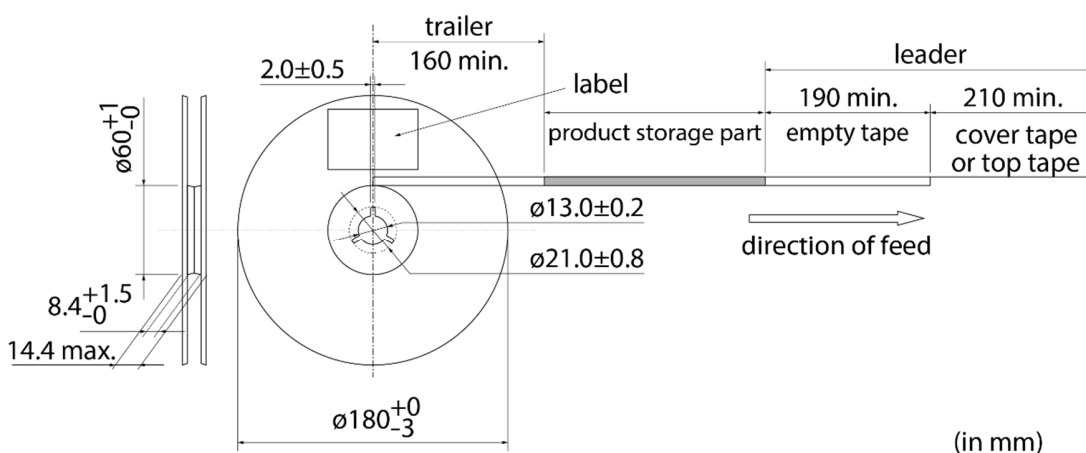

(in mm)

**9.6 Marking for reel**

Customer part number, Murata part number, inspection number (\*1), RoHS marking (\*2), quantity, etc.

<p>*1 Expression of inspection No.:</p> <p>□□    ○○○○    ◇◇◇◇</p> <p>(1)    (2)    (3)</p>	<p>(1) Factory code</p> <p>(2) Date</p> <p>First digit: year/last digit of year</p> <p>Second digit: month/Jan. to Sep.→1 to 9, Oct. to Dec.→O, N, D</p> <p>Third, Fourth digit: day</p> <p>(3) Serial No.</p>
<p>*2 Expression of RoHS marking:</p> <p>ROHS-    Y    (△)</p> <p>(1)    (2)</p>	<p>(1) RoHS regulation conformity</p> <p>(2) Murata classification number</p>

**9.7 Marking on outer box (corrugated box)**

Customer name, purchasing order number, customer part number, Murata part number, RoHS marking (\*2), quantity, etc.

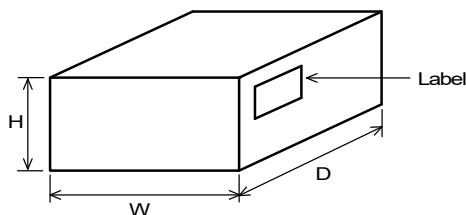
**9.8 Specification of outer box**

Dimensions of outer box (mm)			Standard reel quantity in outer box (reel)
W	D	H	
186	186	93	5
* Above outer box size is typical. It depends on a quantity of an order.			

**10. ⚠Caution****10.1 Restricted applications**

Please contact us before using our products for the applications listed below which require especially high reliability for the prevention of defects which might directly cause damage to the third party's life, body or property.

- |                                   |                                                                                                                 |
|-----------------------------------|-----------------------------------------------------------------------------------------------------------------|
| (1) Aircraft equipment            | (6) Transportation equipment (trains, ships, etc.)                                                              |
| (2) Aerospace equipment           | (7) Traffic signal equipment                                                                                    |
| (3) Undersea equipment            | (8) Disaster/crime prevention equipment                                                                         |
| (4) Power plant control equipment | (9) Data-processing equipment                                                                                   |
| (5) Medical equipment             | (10) Applications of similar complexity and/or reliability requirements to the applications listed in the above |

**10.2 Precautions on rating**

Avoid using in exceeded the rated temperature range, rated voltage, or rated current.

Usage when the ratings are exceeded could lead to wire breakage, burning, or other serious fault.

**10.3 Inrush current**

If an inrush current (or pulse current or rush current) that significantly exceeds the rated current is applied to the product, overheating could occur, resulting in wire breakage, burning, or other serious fault.

**10.4 Fail-safe**

Be sure to provide an appropriate fail-safe function on your product to prevent a second damage that may be caused by the abnormal function or the failure of our product.

**11.5 Corrosive gas**

Please refrain from use since contact with environments with corrosive gases (sulfur gas [hydrogen sulfide, sulfur dioxide, etc.], chlorine, ammonia, etc.) or oils (cutting oil, silicone oil, etc.) that have come into contact with the previously stated corrosive gas environment will result in deterioration of product quality or an open from deterioration due to corrosion of product electrode, etc. We will not bear any responsibility for use under these environments.

**11. Precautions for Use**

This product is for use only with reflow soldering. It is designed to be mounted by soldering. If you want to use other mounting method, for example, using a conductive adhesive, please consult us beforehand.

Also, if repeatedly subjected to temperature cycles or other thermal stress, due to the difference in the coefficient of thermal expansion with the mounting substrate, the solder (solder fillet part) in the mounting part may crack.

The occurrence of cracks due to thermal stress is affected by the size of the land where mounted, the solder volume, and the heat dissipation of the mounting substrate. Carefully design it when a large change in ambient temperature is assumed.

**11.1 Land dimensions**

The following diagram shows the recommended land dimensions for reflow soldering.

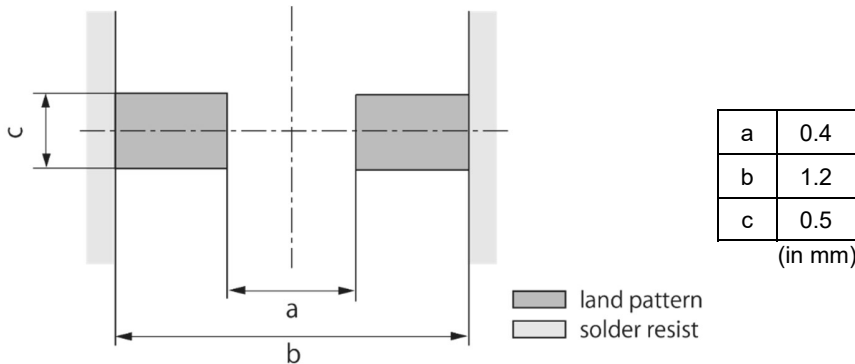

**11.2 Flux and solder used**

Flux	<ul style="list-style-type: none"> <li>• Use a rosin-based flux.</li> <li>• Do not use a highly acidic flux with a halide content exceeding 0.2(wt)% (chlorine conversion value).</li> <li>• Do not use a water-soluble flux.</li> </ul>
Solder	<ul style="list-style-type: none"> <li>• Use Sn-3.0Ag-0.5Cu solder.</li> <li>• Standard thickness of solder paste: 100 μm to 200 μm</li> </ul>

If you want to use a flux other than the above, please consult our technical department.

**11.3 Soldering conditions (reflow)**

- Pre-heating should be in such a way that the temperature difference between solder and product surface is limited to 100°C max. Cooling into solvent after soldering also should be in such a way that the temperature difference is limited to 100°C max. Insufficient pre-heating may cause cracks on the product, resulting in the deterioration of product quality.
- Standard soldering profile and the limit soldering profile is as follows. The excessive limit soldering conditions may cause leaching of the electrode and/or resulting in the deterioration of product quality.

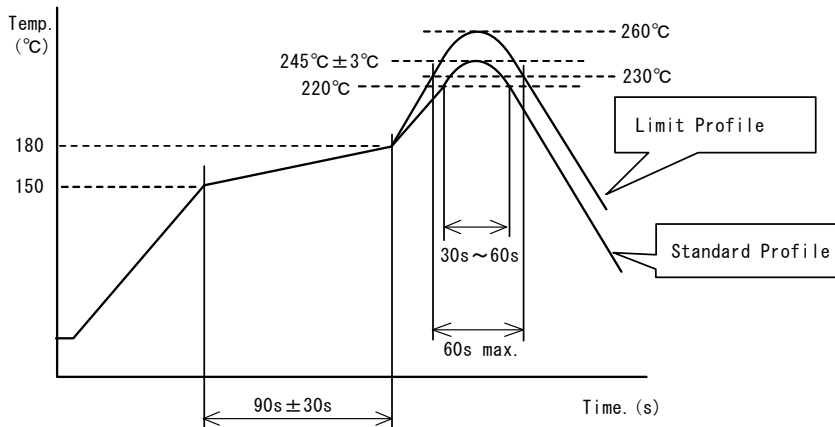

	Standard profile	Limit profile
Pre-heating	150°C to 180°C/90 s±30 s	150°C to 180°C/90 s±30 s
Heating	Above 220°C/30 s to 60 s	Above 230°C/60 s max.
Peak temperature	245°C±3°C	260°C/10 s
Number of reflow cycles	2 times	2 times

**11.4 Reworking with soldering iron**

The following requirements must be met to rework a soldered product using a soldering iron.

Item	Requirement
Pre-heating	150°C/approx. 1 min
Tip temperature of soldering iron	350°C max.
Power consumption of soldering iron	80 W max.
Tip diameter of soldering iron	ø3 mm max.
Soldering time	3 s (+1 s, -0 s)
Number of reworking operations	2 times max.
* Avoid a direct contact of the tip of the soldering iron with the product. Such a direction contact may cause cracks in the ceramic body due to thermal shock.	

**11.5 Solder volume**

Solder shall be used not to increase the volume too much.

An increased solder volume increases mechanical stress on the product. Exceeding solder volume may cause the failure of mechanical or electrical performance.

**11.6 Product's location**

The following shall be considered when designing and laying out PCBs.

(1) PCB shall be designed so that products are not subject to mechanical stress due to warping the board.

[Products direction]

Products shall be located in the sideways direction (length:  $a < b$ ) to the mechanical stress.

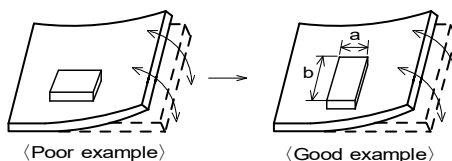

(2) Components location on PCB separation

It is effective to implement the following measures, to reduce stress in separating the board.

It is best to implement all of the following three measures; however, implement as many measures as possible to reduce stress.

Contents of measures	Stress level
(1) Turn the mounting direction of the component parallel to the board separation surface.	$A > D^1$
(2) Add slits in the board separation part.	$A > B$
(3) Keep the mounting position of the component away from the board separation surface.	$A > C$
*1 $A > D$ is valid when stress is added vertically to the perforation as with hand separation. If a cutting disc is used, stress will be diagonal to the PCB, therefore $A > D$ is invalid.	

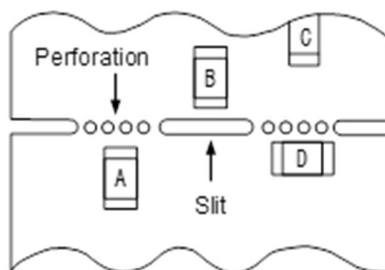



(3) Mounting components near screw holes

When a component is mounted near a screw hole, it may be affected by the board deflection that occurs during the tightening of the screw.

Mount the component in a position as far away from the screw holes as possible.

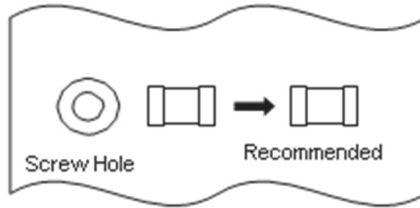

**11.7 Handling of substrate**

After mounting products on a substrate, do not apply any stress to the product caused by bending or twisting to the substrate when cropping the substrate, inserting and removing a connector from the substrate or tightening screw to the substrate. Excessive mechanical stress may cause cracking in the product.

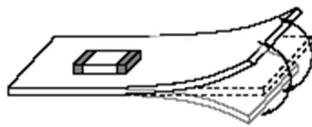

Bending

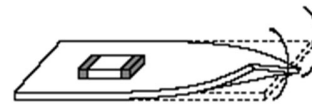

Twisting

**11.8 Cleaning**

When cleaning this product, observe the following conditions.

Any cleaning may cause deterioration in the quality of the product, so please check the quality of this product before use.

- (1) The cleaning temperature shall be 60°C max. If isopropyl alcohol (IPA) is used, the cleaning temperature shall be 40°C max.
- (2) When ultrasonic cleaning is used, under some cleaning conditions, the substrate could resonate and the substrate vibrations could result in chip cracks, solder breakage, and other problems. Be sure to always perform a test cleaning beforehand using an actual cleaning device, and then check the quality of the products.

(3) Cleaner

Alcohol-based cleaner: IPA

Aqueous agent: PINE ALPHA ST-100S

(4) There shall be no residual flux or residual cleaner.

When using aqueous agent, rinse the product with deionized water adequately and completely dry it so that no cleaner is left.

\* For other cleaning, please consult our technical department.

**11.9 Storage and transportation**

Storage period	Use the product within 12 months after delivery. If you do not use the product for more than 12 months, check solderability before using it.
Storage conditions	<ul style="list-style-type: none"> <li>• The products shall be stored in a room not subject to rapid changes in temperature and humidity. The recommended temperature range is -10°C to +40°C. The recommended relative humidity range is 15% to 85%. Keeping the product in corrosive gases, such as sulfur, chlorine gas or acid may cause the poor solderability.</li> <li>• Do not place the products directly on the floor; they should be placed on a palette so that they are not affected by humidity or dust.</li> <li>• Avoid keeping the products in a place exposed to direct sunlight, heat or vibration.</li> <li>• Do not keep products in bulk packaging. Bulk storage could result in collisions between the products or between the products and other parts, resulting in chipping or wire breakage.</li> <li>• Avoid storing the product by itself bare (i.e. exposed directly to air).</li> </ul>
Transportation	Excessive vibration and impact reduces the reliability of the products. Exercise caution when handling the products.