

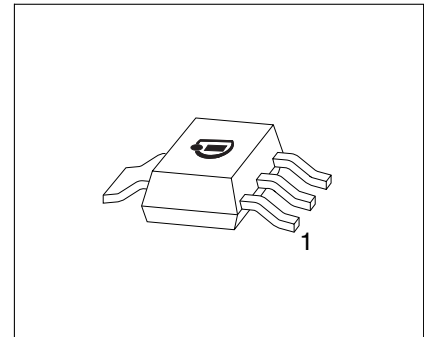

- High-side switch
- Short-circuit protection
- Input protection
- Overtemperature protection with hysteresis
- Overload protection
- Overvoltage protection
- Switching inductive load
- Clamp of negative output voltage with inductive loads
- Undervoltage shutdown
- Maximum current internally limited
- **Electrostatic discharge (ESD)** protection
- Reverse battery protection¹⁾
- AEC qualified
- Green product (RoHS compliant)



PG-SOT-223

Application

- μC compatible power switch for 12 V DC grounded loads
- All types of resistive, inductive and capacitive loads
- Replaces electromechanical relays and discrete circuits

General Description

N channel vertical power FET with charge pump, ground referenced CMOS compatible input, monolithically integrated in Smart SIPMOS® technology. Fully protected by embedded protection functions.

Blockdiagramm:

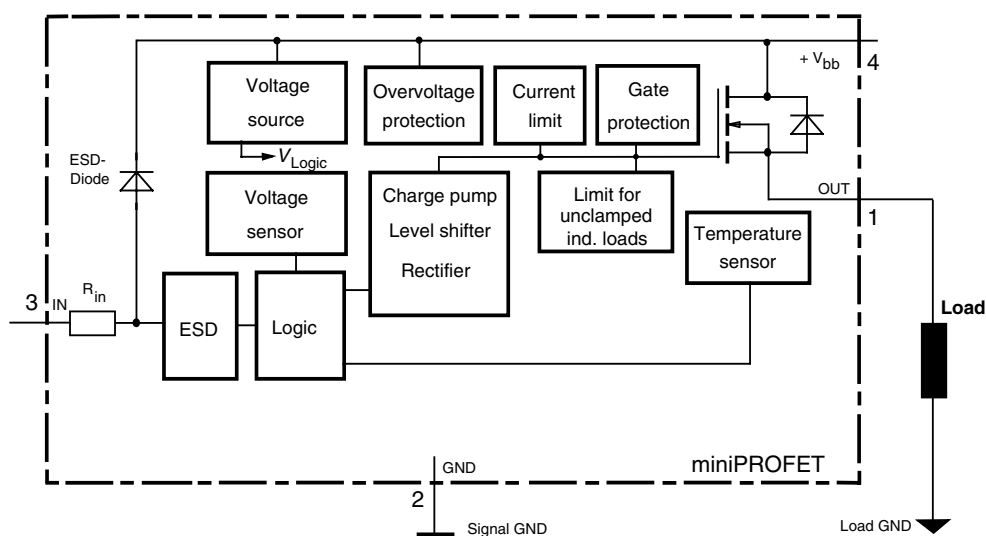

¹⁾ With resistor $R_{\text{GND}}=150 \Omega$ in GND connection, resistor in series with IN connections reverse load current limited by connected load.

Pin	Symbol		Function
1	OUT	O	Output to the load
2	GND	-	Logic ground
3	IN	I	Input, activates the power switch in case of logical high signal
4	Vbb	+	Positive power supply voltage

Maximum Ratings at $T_j = 25\text{ °C}$ unless otherwise specified

Parameter		Symbol	Values	Unit
Supply voltage		V_{bb}	40	V
Load current	self-limited	I_L	$I_{L(SC)}$	A
Maximum input voltage ²⁾		V_{IN}	-5.0... V_{bb}	V
Maximum input current		I_{IN}	± 5	mA
Inductive load switch-off energy dissipation, single pulse (not tested, specified by design)	$I_L = 0.5\text{A}$, $T_A = 150\text{°C}$	E_{AS}	0.5	J
Load dump protection ³⁾ $V_{LoadDump} = U_A + V_S$ $R_L = 24\Omega$ $R_I = 2\Omega$, $t_d = 400\text{ms}$, IN = low or high, $U_A = 13.5\text{V}$ $R_L = 80\Omega$ (not tested, specified by design)		$V_{Load\ dump}^{4)}$	60 80	V
Electrostatic discharge capability (ESD) ⁵⁾	PIN 3 PIN 1,2,4	V_{ESD}	± 1 ± 2	kV
Operating temperature range		T_j	-40 ... +150	°C
Storage temperature range		T_{stg}	-55 ... +150	°C
Max. power dissipation (DC) ⁶⁾	$T_A = 25\text{ °C}$	P_{tot}	1.8	W
Thermal resistance	chip - soldering point: chip - ambient: ⁶⁾	R_{thJS} R_{thJA}	7 70	K/W

²⁾ At $V_{IN} > V_{bb}$, the input current is not allowed to exceed ± 5 mA.

³⁾ Supply voltages higher than $V_{bb(AZ)}$ require an external current limit for the GND pin, e.g. with a $150\ \Omega$ resistor in the GND connection. A resistor for the protection of the input is integrated.

⁴⁾ $V_{Load\ dump}$ is setup without the DUT connected to the generator per ISO 7637-1 and DIN 40839

⁵⁾ HBM according to MIL-STD 883D, Methode 3015.7

⁶⁾ BSP 452 on epoxy pcb 40 mm x 40 mm x 1.5 mm with 6 cm² copper area for V_{bb} connection

Electrical Characteristics

Parameter and Conditions at $T_j = 25^\circ\text{C}$, $V_{bb} = 13.5\text{V}$ unless otherwise specified	Symbol	Values			Unit
		min	typ	max	

Load Switching Capabilities and Characteristics

On-state resistance (pin 4 to 1) $I_L = 0.5\text{ A}$, $V_{in} = \text{high}$	$T_j = 25^\circ\text{C}$ $T_j = 150^\circ\text{C}$	R_{ON}	-- --	0.16 --	0.2 0.4	Ω
Nominal load current (pin 4 to 1) ⁷⁾ ISO Standard: $V_{ON} = V_{bb} - V_{OUT} = 0.5\text{ V}$ $T_S = 85^\circ\text{C}$		$I_{L(ISO)}$	0.7	--	--	A
Turn-on time Turn-off time $R_L = 24\ \Omega$	to 90% V_{OUT} to 10% V_{OUT}	t_{on} t_{off}	-- --	60 60	100 150	μs
Slew rate on 10 to 30% V_{OUT} , $R_L = 24\ \Omega$		dV/dt_{on}	--	2	4	$\text{V}/\mu\text{s}$
Slew rate off 70 to 40% V_{OUT} , $R_L = 24\ \Omega$		$-dV/dt_{off}$	--	2	4	$\text{V}/\mu\text{s}$

Input

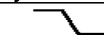
Allowable input voltage range, (pin 3 to 2)		V_{IN}	-3.0	--	V_{bb}	V
Input turn-on threshold voltage  $T_j = -40\dots+150^\circ\text{C}$		$V_{IN(T+)}$	--	--	3.5	V
Input turn-off threshold voltage  $T_j = -40\dots+150^\circ\text{C}$		$V_{IN(T-)}$	1.5	--	--	V
Input threshold hysteresis		$\Delta V_{IN(T)}$	--	0.5	--	V
Off state input current (pin 3) $V_{IN(off)} = 1.2\text{ V}$ $T_j = -40\dots+150^\circ\text{C}$		$I_{IN(off)}$	10	--	60	μA
On state input current (pin 3) $V_{IN(on)} = 3.0\text{ V to } V_{bb}$ $T_j = -40\dots+150^\circ\text{C}$		$I_{IN(on)}$	10	--	100	μA
Input resistance		R_{IN}	1.5	2.8	3.5	$\text{k}\Omega$

⁷⁾ $I_{L(ISO)}$ is limited by current limitation, see $I_{L(SC)}$, next page

Parameter and Conditions at $T_j = 25^\circ\text{C}$, $V_{bb} = 13.5\text{V}$ unless otherwise specified	Symbol	Values			Unit	
		min	typ	max		
Operating Parameters						
Operating voltage ⁸⁾	$T_j = -40\dots+150^\circ\text{C}$	$V_{bb(\text{on})}$	5.0	--	34	V
Undervoltage shutdown	$T_j = -40\dots+150^\circ\text{C}$	$V_{bb(\text{under})}$	3.5	--	5	V
Undervoltage restart	$T_j = -40\dots+25^\circ\text{C}$ $T_j = +150^\circ\text{C}$	$V_{bb(\text{u rst})}$	--	--	6.5 7.0	V
Undervoltage restart of charge pump see diagram page 7		$V_{bb(\text{ucp})}$	--	5.6	7	V
Undervoltage hysteresis $\Delta V_{bb(\text{under})} = V_{bb(\text{u rst})} - V_{bb(\text{under})}$		$\Delta V_{bb(\text{under})}$	--	0.3	--	V
Overvoltage shutdown	$T_j = -40\dots+150^\circ\text{C}$	$V_{bb(\text{over})}$	34	--	42	V
Overvoltage restart	$T_j = -40\dots+150^\circ\text{C}$	$V_{bb(\text{o rst})}$	33	--	--	V
Overvoltage hysteresis	$T_j = -40\dots+150^\circ\text{C}$	$\Delta V_{bb(\text{over})}$	--	0.7	--	V
Standby current (pin 4), $V_{in} = \text{low}$	$T_j = -40\dots+150^\circ\text{C}$	$I_{bb(\text{off})}$	--	10	25	μA
Operating current (pin 2), $V_{in} = 5\text{V}$		I_{GND}	--	1	1.6	mA
leakage current (pin 1) $V_{in} = \text{low}$	$T_j = -40\dots+25^\circ\text{C}$ $T_j = 150^\circ\text{C}$	$I_{L(\text{off})}$	--	2	5 7	μA

Protection Functions

Current limit (pin 4 to 1) $V_{bb} = 20\text{V}$	$T_j = 25^\circ\text{C}$ $T_j = -40\dots+150^\circ\text{C}$	$I_L(\text{SC})$	0.7 0.7	1.5 --	2 2.4	A
Overvoltage protection $I_{bb}=4\text{mA}$	$T_j = -40\dots+150^\circ\text{C}$	$V_{bb(\text{AZ})}$	41	--	--	V
Output clamp (ind. load switch off) at $V_{\text{OUT}}=V_{bb}-V_{\text{ON}(\text{CL})}$, $I_{bb} = 4\text{mA}$		$V_{\text{ON}(\text{CL})}$	41	47	--	V
Thermal overload trip temperature		T_{jt}	150	--	--	$^\circ\text{C}$
Thermal hysteresis		ΔT_{jt}	--	10	--	K
Inductive load switch-off energy dissipation ⁹⁾ $T_{j \text{ Start}} = 150^\circ\text{C}$, single pulse, $I_L = 0.5\text{A}$, $V_{bb} = 12\text{V}$ (not tested, specified by design)		E_{AS}	--	--	0.5	J
Reverse battery (pin 4 to 2) ¹⁰⁾ (not tested, specified by design)		$-V_{bb}$	--	--	30	V

⁸⁾ At supply voltage increase up to $V_{bb}=5.6\text{V}$ typ without charge pump, $V_{\text{OUT}} \approx V_{bb} - 2\text{V}$

⁹⁾ While demagnetizing load inductance, dissipated energy in PROFET is $E_{\text{AS}} = \int V_{\text{ON}(\text{CL})} \cdot i_L(t) dt$, approx.

$$E_{\text{AS}} = \frac{1}{2} \cdot L \cdot I_L^2 \cdot \left(\frac{V_{\text{ON}(\text{CL})}}{V_{\text{ON}(\text{CL})} - V_{bb}} \right)$$

¹⁰⁾ Requires $150\ \Omega$ resistor in GND connection. Reverse load current (through intrinsic drain-source diode) is normally limited by the connected load.

Max. allowable power dissipation

$$P_{tot} = f(T_A, T_{SP})$$

P_{tot} [W]

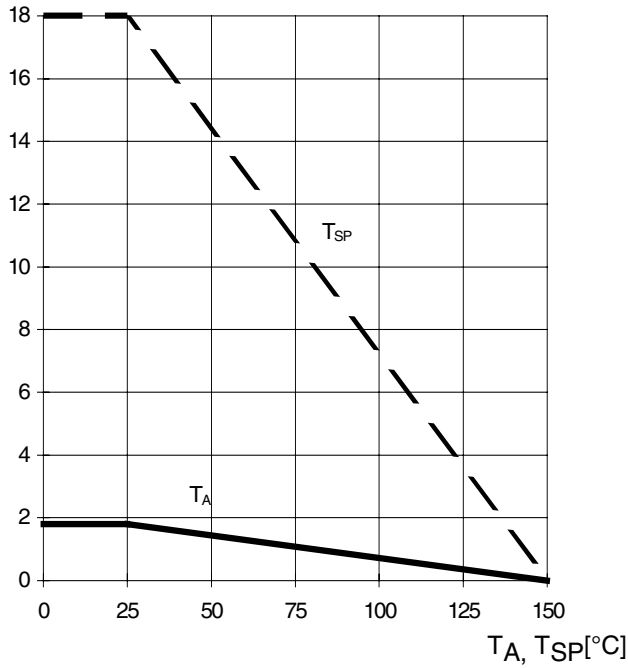

Current limit characteristic

$$I_{L(SC)} = f(V_{on}); (V_{on} \text{ see testcircuit})$$

$I_{L(SC)}$ [A]

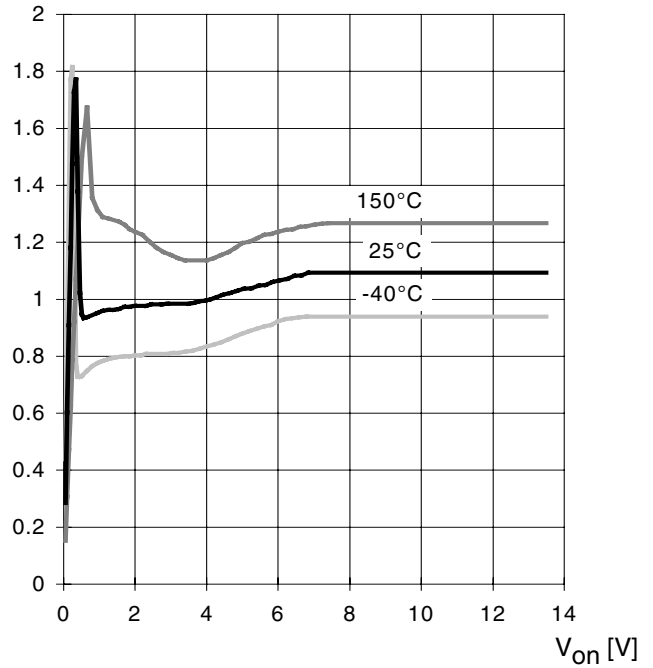

On state resistance (Vbb-pin to OUT-pin)

$$R_{ON} = f(T_j); V_{bb} = 13.5 \text{ V}; I_L = 0.5 \text{ A}$$

R_{ON} [Ω]

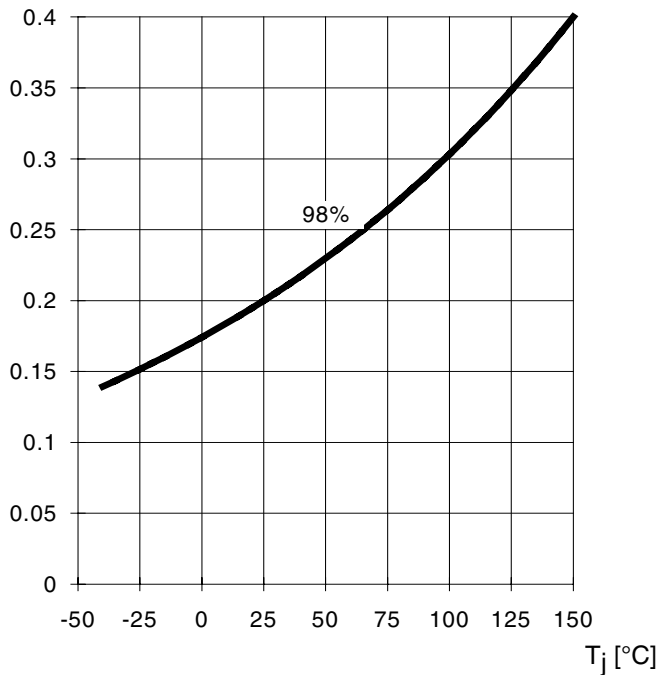

Typ. input current

$$I_{IN} = f(V_{IN}); V_{bb} = 13.5 \text{ V}$$

I_{IN} [μA]

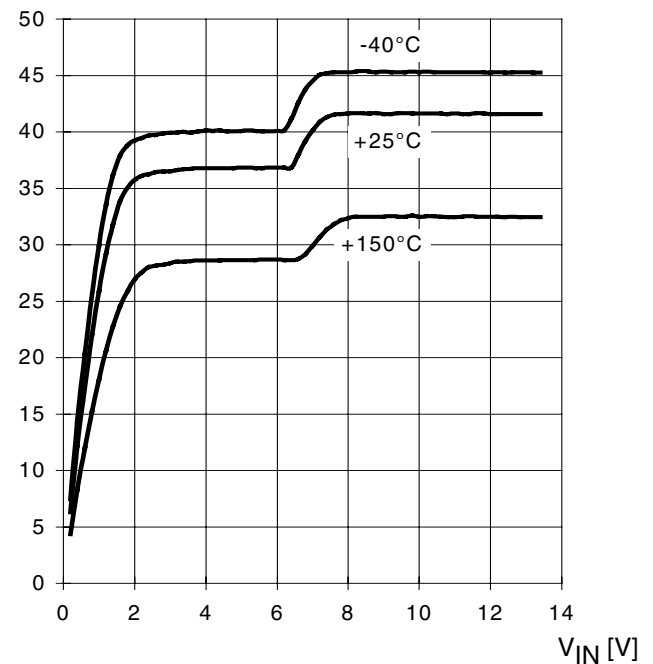

Typ. operating current

$I_{GND} = f(T_j)$; $V_{bb} = 13,5\text{ V}$; $V_{IN} = \text{high}$

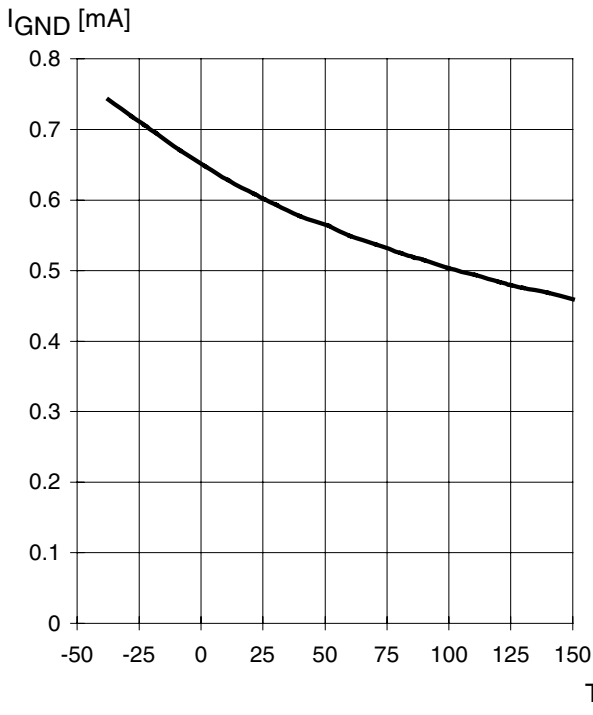

Typ. overload current

$I_{L(\text{lim})} = f(t)$; $V_{bb} = 13,5\text{ V}$, no heatsink, Param.: $T_{j\text{start}}$

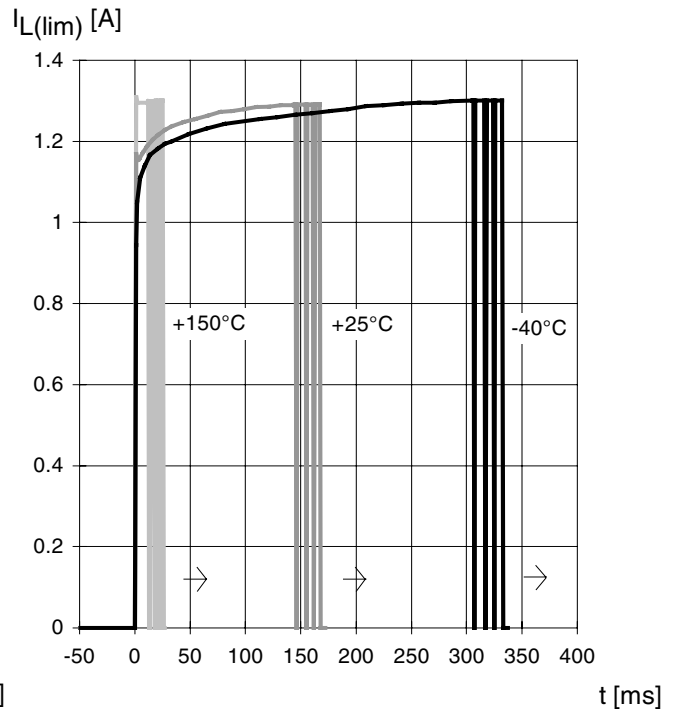

Typ. standby current

$I_{bb(\text{off})} = f(T_j)$; $V_{bb} = 13,5\text{ V}$; $V_{IN} = \text{low}$

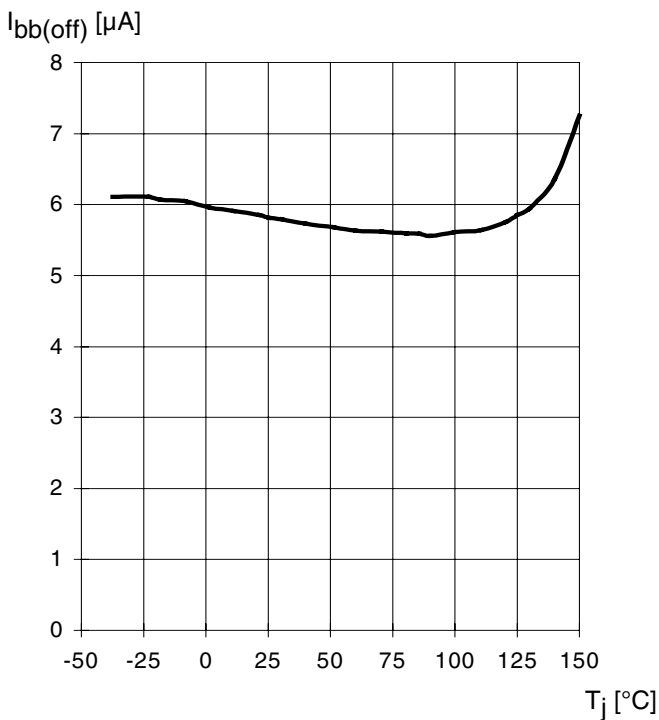

Short circuit current

$I_{L(\text{SC})} = f(T_j)$; $V_{bb} = 13,5\text{ V}$

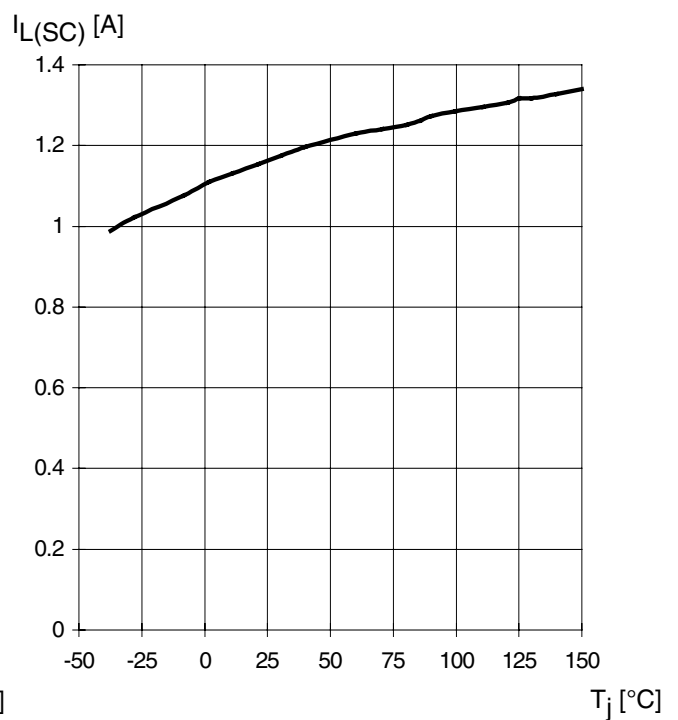

Typ. input turn on voltage threshold

$$V_{IN(T+)} = f(T_j);$$

$V_{IN(T+)} [V]$

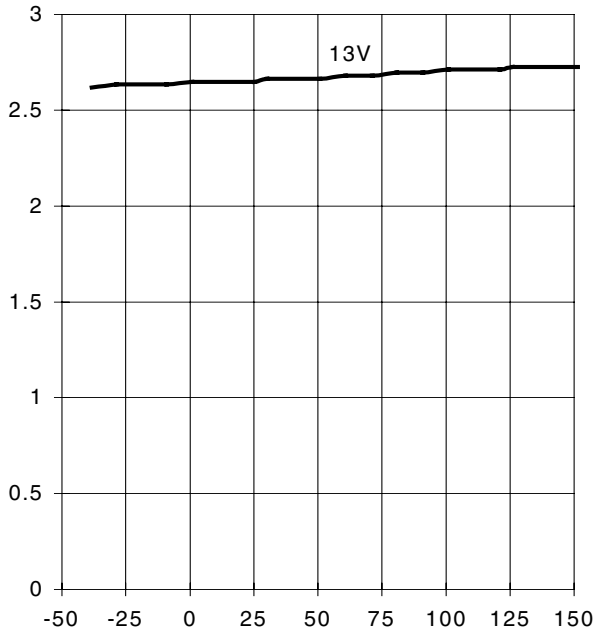

$T_j [^{\circ}C]$

Figure 6: Undervoltage restart of charge pump

$V_{ON} [V]$

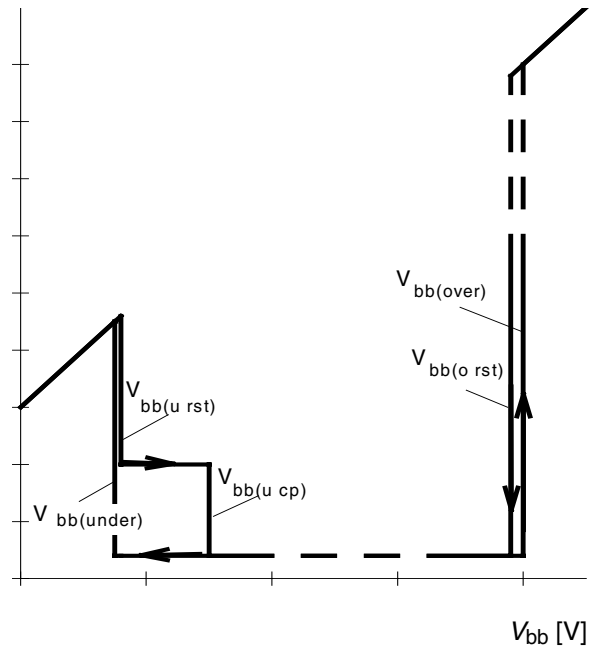

charge pump starts at $V_{bb(ucp)}$ about 7 V typ.

$V_{bb} [V]$

Typ. on-state resistance (V_{bb} -Pin to Out-Pin)

$$R_{ON} = f(V_{bb}, I_L); I_L = 0.5A, T_j = 25^{\circ}C$$

$R_{ON} [m\Omega]$

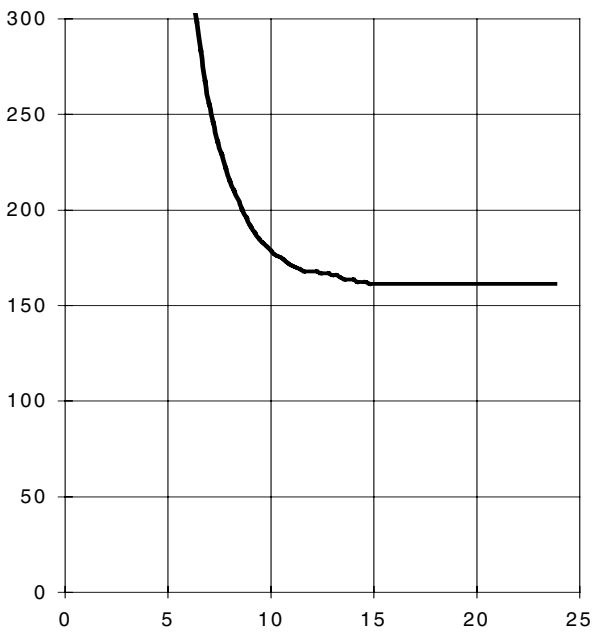

$V_{bb} [V]$

Test circuit

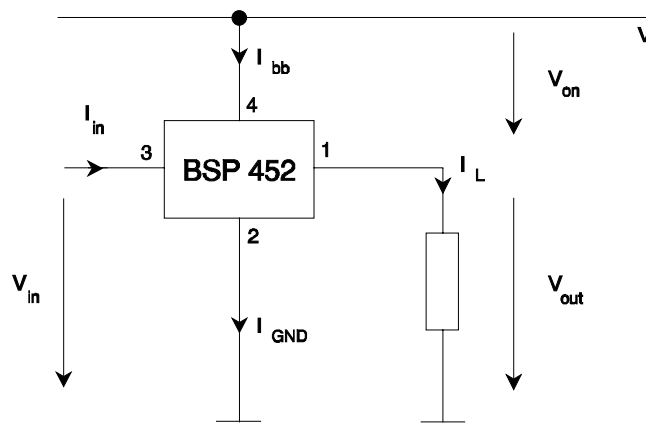

Revision History

Version	Date	Changes
1.0	2007-05-25	Creation of the green datasheet. First page : Adding the green logo and the AEC qualified Adding the bullet AEC qualified and the RoHS compliant features Package page Modification of the package to be green.