



BTA04 T/D/S/A BTB04 T/D/S/A

SENSITIVE GATE TRIACS

FEATURES

- Very low $I_{GT} = 10\text{mA max}$
- Low $I_H = 15\text{mA max}$
- BTA Family:
Insulating voltage = $2500V_{(RMS)}$
(UL recognized: E81734)

DESCRIPTION

The BTA/BTB04 T/D/S/A triac family are high performance glass passivated PNP devices. These parts are suitable for general purpose applications where gate high sensitivity is required. Application on 4Q such as phase control and static switching.

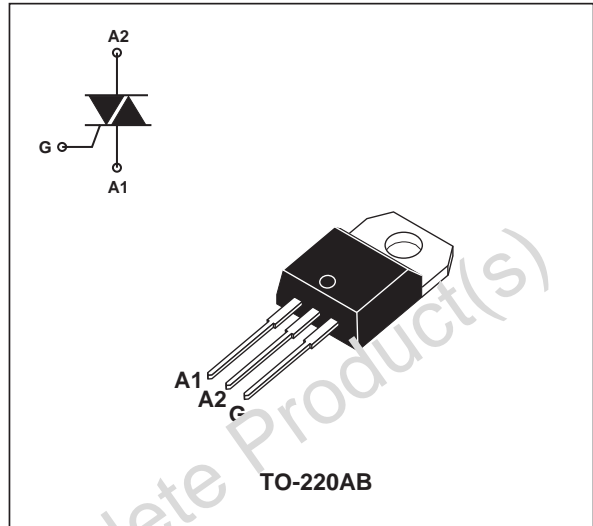

ABSOLUTE RATINGS (limiting values)

Symbol	Parameter		Value	Unit	
$I_{T(RMS)}$	RMS on-state current (360° conduction angle)	BTA	$T_c = 90^\circ\text{C}$	4	A
		BTB	$T_c = 95^\circ\text{C}$		
I_{TSM}	Non repetitive surge peak on-state current (T_j initial = 25°C)		$t_p = 8.3\text{ms}$	42	A
			$t_p = 10\text{ms}$		
I^2t	I^2t value		$t_p = 10\text{ms}$	8	A^2s
di/dt	Critical rate of rise of on-state current Gate supply: $I_G = 50\text{mA}$ $di_G/dt = 0.1\text{A}/\mu\text{s}$		Repetitive $F = 50\text{Hz}$	10	$\text{A}/\mu\text{s}$
			Non repetitive	50	
T_{stg} T_j	Storage and operating junction temperature range			-40 to +150 -40 to +110	$^\circ\text{C}$
T_l	Maximum lead soldering temperature during 10s at 4.5mm from case			260	$^\circ\text{C}$

Symbol	Parameter	BTA / BTB04-			Unit
		400 T/D/S/A	600 T/D/S/A	700 T/D/S/A	
V_{DRM} V_{RRM}	Repetitive peak off-state voltage $T_j = 110^\circ\text{C}$	400	600	700	V

THERMAL RESISTANCE

Symbol	Parameter	Value	Unit
Rth (j-a)	Junction to ambient	60	°C/W
Rth (j-c) DC	Junction to case for DC	BTA	4.4
		BTB	3.2
Rth (j-c) AC	Junction to case for 360° conduction angle (F = 50Hz)	BTA	3.3
		BTB	2.4

GATE CHARACTERISTICS (maximum values)

$P_{G(AV)} = 1W$ $P_{GM} = 40W$ (tp = 20µs) $I_{GM} = 4A$ (tp = 20µs) $V_{GM} = 16V$ (tp = 20µs)

ELECTRICAL CHARACTERISTICS

Symbol	Test conditions	Quadrant		BTA / BTB04				Unit
				T	D	S	A	
I _{GT}	V _D = 12V (DC) R _L = 33Ω T _j = 25°C	I - II - III	MAX.	5	5	10	10	mA
		IV	MAX.	5	10	10	25	
V _{GT}	V _D = 12V (DC) R _L = 33Ω T _j = 25°C	I - II - III - IV	MAX.	1.5				V
V _{GD}	V _D = V _{DRM} R _L = 3.3kΩ T _j = 110°C	I - II - III - IV	MIN.	0.2				V
tgt	V _D = V _{DRM} I _G = 40mA di _G /dt = 0.5A/µs T _j = 25°C	I - II - III - IV	TYP.	2				µs
I _L	I _G = 1.2I _{GT} T _j = 25°C	I - III - IV	TYP.	10	10	20	20	mA
		II		20	20	40	40	
I _H *	I _T = 100mA Gate open T _j = 25°C		MAX.	15	15	25	25	mA
V _{TM} *	I _{TM} = 5.5A tp = 380µs T _j = 25°C		MAX.	1.65				V
I _{DRM} I _{RRM}	V _{DRM} rated V _{RRM} rated T _j = 25°C		MAX.	0.01				mA
			MAX.	0.75				
dV/dt*	Linear slope up to V _D = 67% V _{DRM} gate open T _j = 110°C		TYP.	10	10	-	-	V/µs
			MIN.	-	-	10	10	
(di/dt)c*	(di/dt)c = 1.8A/ms T _j = 110°C		TYP.	1	1	5	5	V/µs

* For either polarity of electrode A₂ voltage with reference to electrode A₁

PRODUCT INFORMATION

Package	$I_{T(RMS)}$	V_{DRM} / V_{RRM}	Sensitivity Specification			
	A	V	T	D	S	A
BTA (Insulated)	4	400	X			X
		600	X	X		
		700	X		X	
BTB (Uninsulated)	4	400	X	X		
		600	X		X	

ORDERING INFORMATION

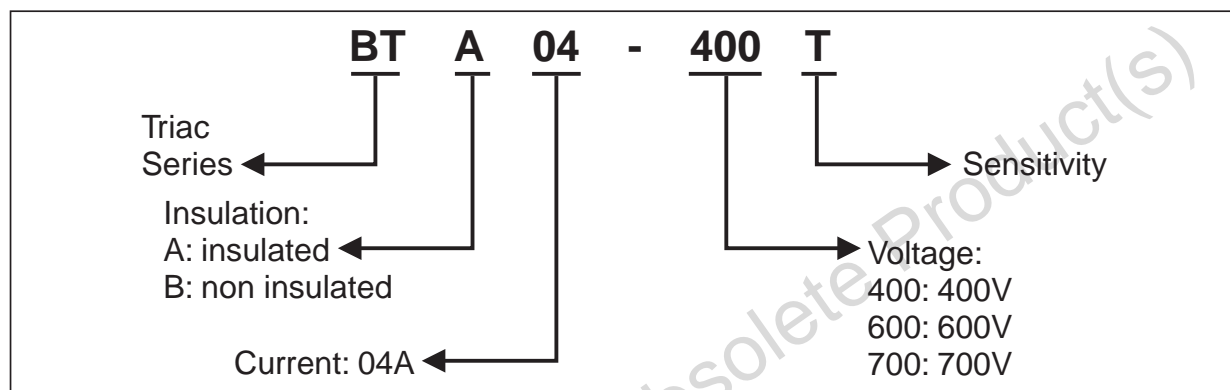

Fig. 1: Maximum RMS power dissipation versus RMS on-state current ($F = 50\text{Hz}$). (Curves are cut off by $(di/dt)_c$ limitation)

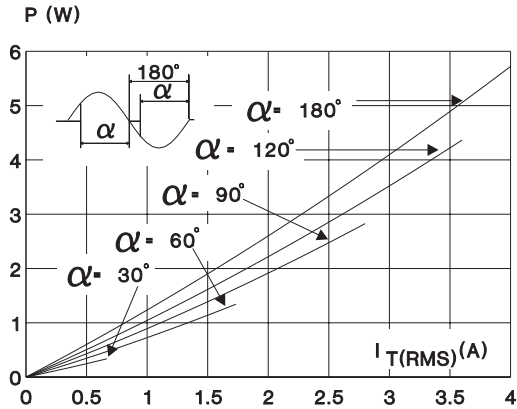

Fig. 2: Correlation between maximum RMS power dissipation and maximum allowable temperature (T_{amb} and T_{case}) for different thermal resistances heatsink + contact (BTA).

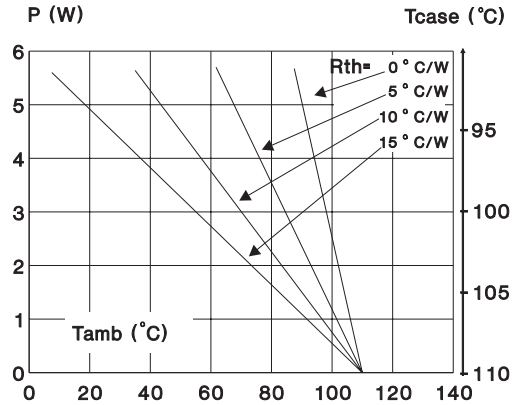

Fig. 3: Correlation between maximum RMS power dissipation and maximum allowable temperature (T_{amb} and T_{case}) for different thermal resistances heatsink + contact (BTB).

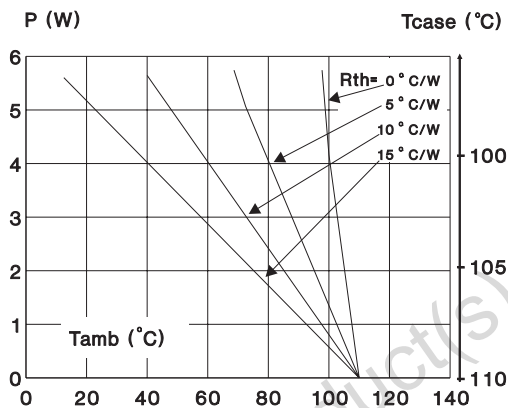

Fig. 4: RMS on-state current versus case temperature.

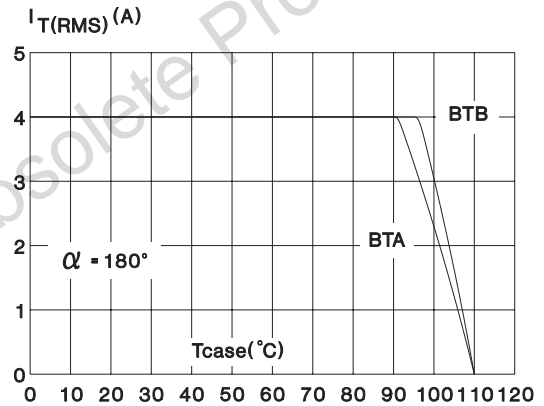

Fig. 5: Relative variation of thermal impedance versus pulse duration.

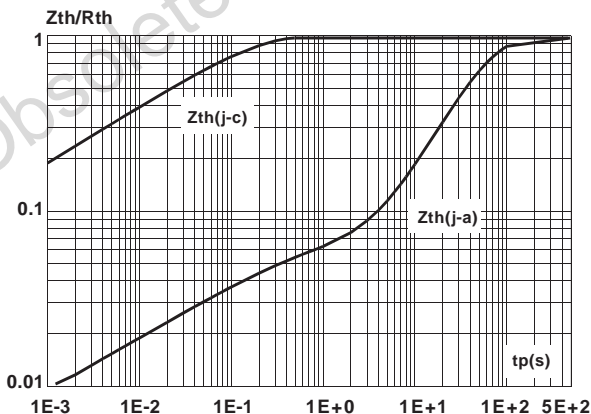

Fig. 6: Relative variation of gate trigger current and holding current versus junction temperature.

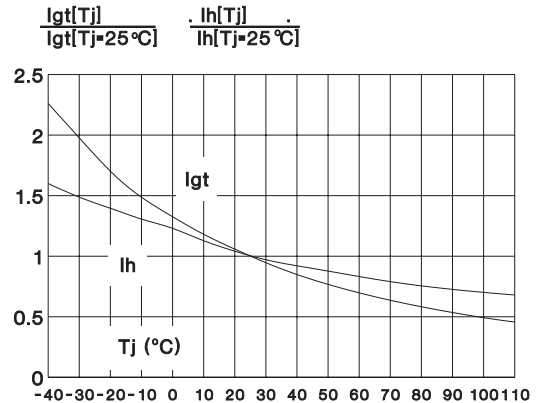

Fig. 7: Non repetitive surge peak on-state current versus number of cycles.

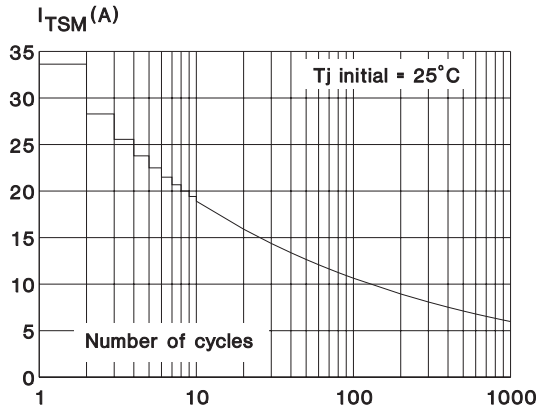

Fig. 8: Non repetitive surge peak on-state current for a sinusoidal pulse with width: $t \leq 10\text{ms}$, and corresponding value of I^2t .

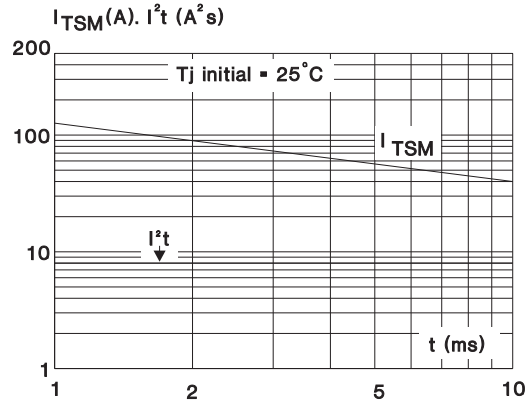
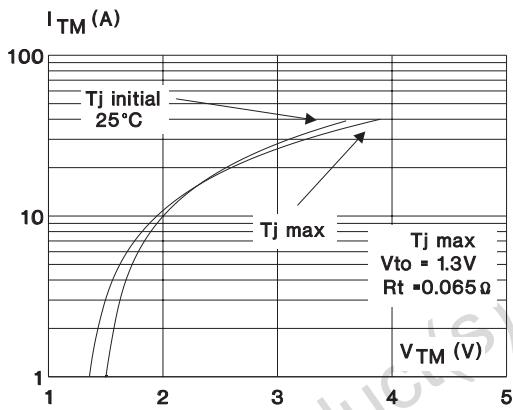

Fig. 9: On-state characteristics (maximum values).



Obsolete Product(s) - Obsolete Product(s)