

## 10 A Snubberless™, logic level and standard Triacs

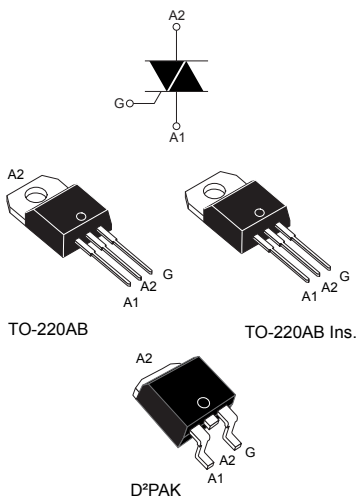

### Features

- Medium current Triac
- Low thermal resistance with clip bonding
- Low thermal resistance insulation ceramic for insulated BTA
- High commutation (4Q) or very high commutation (3Q, Snubberless™) capability
- BTA series UL1557 certified (file ref: 81734)
- Packages are RoHS (2002/95/EC) compliant

### Description

Available either in through-hole or surface mount packages, the BTA10, BTB10 and T10xx Triac series are suitable for general purpose mains power AC switching. They can be used as ON/OFF function in applications such as static relays, heating regulation or induction motor starting circuit. They are also recommended for phase control operations in light dimmers and appliance motors speed controllers.

The Snubberless™ versions (W suffix and T10xx) are especially recommended for use on inductive loads, because of their high commutation performance. By using an internal ceramic pad, the Snubberless™ series provide an insulated tab (rated at 2500 V<sub>RMS</sub>) complying with UL standards (file reference: E81734).

#### Product status link

[BTA10, BTB10, T1035, T1050](#)

#### Product summary

|                   |               |
|-------------------|---------------|
| $I_{T(RMS)}$      | 10 A          |
| $V_{DRM}/V_{RRM}$ | 600 and 800 V |
| $I_{GT}$          | 25 to 50 mA   |

# 1 Characteristics

**Table 1. Absolute maximum ratings**

| Symbol            | Parameters   |                                   |                                   | Value                   | Unit                   |                  |
|-------------------|--|-----------------------------------|-----------------------------------|-------------------------|------------------------|------------------|
| $I_{T(RMS)}$      | RMS on-state current (full sine wave)  | TO-220AB                          | $T_c = 105\text{ }^\circ\text{C}$ | 10                      | A                      |                  |
|                   |  | TO-220AB Ins.                     | $T_c = 95\text{ }^\circ\text{C}$  |                         |                        |                  |
| $I_{TSM}$         | Non repetitive surge peak on-state current (full cycle, $T_j$ initial = $25\text{ }^\circ\text{C}$ ) | F = 50 Hz                         | $t_p = 20\text{ ms}$              | 100                     | A                      |                  |
|                   |  | F = 60 Hz                         | $t_p = 16.7\text{ ms}$            | 105                     |                        |                  |
| $I^2t$            | $I^2t$ value for fusing  | $t_p = 10\text{ ms}$              |                                   | 55                      | $\text{A}^2\text{s}$   |                  |
| $di/dt$           | Critical rate of rise of on-state current<br>$I_G = 2 \times I_{GT}$ , $t_r \leq 100\text{ ns}$      | F = 120 Hz                        | $T_j = 125\text{ }^\circ\text{C}$ | 50                      | $\text{A}/\mu\text{s}$ |                  |
| $V_{DSM}/V_{RSM}$ | Non repetitive surge peak off-state voltage  | $t_p = 10\text{ ms}$              | $T_j = 25\text{ }^\circ\text{C}$  | $V_{DRM}/V_{RRM} + 100$ | V                      |                  |
| $I_{GM}$          | Peak gate current  | $t_p = 20\text{ }\mu\text{s}$     | $T_j = 125\text{ }^\circ\text{C}$ | 4                       | A                      |                  |
| $P_{G(AV)}$       | Average gate power dissipation   | $T_j = 125\text{ }^\circ\text{C}$ |                                   | 1                       | W                      |                  |
| $T_{stg}$         | Storage junction temperature range   |                                   |                                   |                         | -40 to +150            | $^\circ\text{C}$ |
| $T_j$             | Operating junction temperature range   |                                   |                                   |                         | -40 to +125            | $^\circ\text{C}$ |

**Table 2. Static electrical characteristics**

| Symbol            | Test conditions   | $T_j$                       |      | Value | Unit             |
|-------------------|---|-----------------------------|------|-------|------------------|
| $V_T^{(1)}$       | $I_{TM} = 14\text{ A}$ , $t_p = 380\text{ }\mu\text{s}$ | $25\text{ }^\circ\text{C}$  | Max. | 1.55  | V                |
| $V_{TO}$          | threshold on-state voltage                              | $125\text{ }^\circ\text{C}$ | Max. | 0.85  | V                |
| $R_D$             | Dynamic resistance                                      | $125\text{ }^\circ\text{C}$ | Max. | 40    | $\text{m}\Omega$ |
| $I_{DRM}/I_{RRM}$ | $V_{DRM} = V_{RRM}$                                     | $25\text{ }^\circ\text{C}$  | Max. | 5     | $\mu\text{A}$    |
|                   |   | $125\text{ }^\circ\text{C}$ |      | 1     | $\text{mA}$      |

1. For both polarities of A2 referenced to A1

**Table 3. Electrical characteristics ( $T_j = 25\text{ }^\circ\text{C}$ , unless otherwise specified) - Snubberless™ (3 quadrants)**

| Symbol        | Parameters   | Quadrant     |      | T1035 | BTA10-xCW<br>BTB10-xCW | T1050<br>BTA10-xBW<br>BTB10-xBW | Unit                   |
|---------------|--|--------------|------|-------|------------------------|---------------------------------|------------------------|
|               |  |              |      |       |                        |                                 |                        |
| $I_{GT}$      | $V_D = 12\text{ V}$ , $R_L = 33\text{ }\Omega$                                   | I - II - III | Max. | 35    |                        | 50                              | $\text{mA}$            |
| $V_{GT}$      |  | I - II - III | Max. | 1.3   |                        |                                 | V                      |
| $V_{GD}$      | $V_D = V_{DRM}$ , $R_L = 3,3\text{ k}\Omega$ , $T_j = 125\text{ }^\circ\text{C}$ | I - II - III | Min. | 0.2   |                        |                                 | V                      |
| $I_H$         | $I_T = 500\text{ mA}$  | I - II - III | Max. | 35    |                        | 50                              | $\text{mA}$            |
| $I_L$         | $I_G = 1.2 I_{GT}$   | I - III      | Max. | 50    |                        | 70                              | $\text{mA}$            |
|               |  | II           | Max. | 80    | 60                     | 80                              |                        |
| $dV/dt^{(2)}$ | $V_D = 67\text{ \% } V_{DRM}$ gate open, $T_j = 125\text{ }^\circ\text{C}$       |              | Min. | 500   |                        | 1000                            | $\text{V}/\mu\text{s}$ |

| Symbol            | Parameters                             | Quadrant |      | T1035 | BTA10-xCW<br>BTB10-xCW | T1050<br>BTA10-xBW<br>BTB10-xBW | Unit |
|-------------------|--|----------|------|-------|------------------------|---------------------------------|------|
| $(di/dt)_c^{(2)}$ | Without snubber, $T_j = 125\text{ °C}$ |          | Min. | 5.5   |                        | 9                               | A/ms |

1. Minimum  $I_{GT}$  is guaranteed at 5 % of  $I_{GT}$  max.
2. For both polarities of A2 referenced to A1

**Table 4. Electrical characteristics ( $T_j = 25\text{ °C}$ , unless otherwise specified) - standard Triac (4 quadrants)**

| Symbol            | Parameters   | Quadrant     |      | Value |     | Unit       |
|-------------------|--|--------------|------|-------|-----|------------|
|                   |  |              |      | C     | B   |            |
| $I_{GT}^{(1)}$    | $V_D = 12\text{ V}$ , $R_L = 33\ \Omega$                             | I - II - III | Max. | 25    | 50  | mA         |
|                   |  | IV           | Max. | 50    | 100 |            |
| $V_{GT}$          |  | All          | Max. | 1.3   |     | V          |
| $V_{GD}$          | $V_D = V_{DRM}$ , $R_L = 3,3\text{ k}\Omega$ , $T_j = 125\text{ °C}$ | I - II - III | Min. | 0.2   |     | V          |
| $I_H^{(2)}$       | $I_T = 500\text{ mA}$  | I - II - III | Max. | 25    | 50  | mA         |
| $I_L$             | $I_G = 1.2\ I_{GT}$  | I - III      | Max. | 40    | 50  | mA         |
|                   |  | II           | Max. | 80    | 100 |            |
| $dV/dt^{(2)}$     | $V_D = 67\% V_{DRM}$ gate open, $T_j = 125\text{ °C}$                |              | Min. | 200   | 400 | V/ $\mu$ s |
| $(dV/dt)_c^{(2)}$ | $(di/dt)_c = 4.4\text{ A/ms}$ , $T_j = 125\text{ °C}$                |              | Min. | 5     | 10  | V/ $\mu$ s |

1. Minimum  $I_{GT}$  is guaranteed at 5 % of  $I_{GT}$  max.
2. For both polarities of A2 referenced to A1

**Table 5. Thermal resistance**

| Symbol               | Parameters  | Value                         | Unit |
|----------------------|---|-------------------------------|------|
| $R_{th(j-c)}$ (typ.) | Junction to case (AC)                             | TO-220AB / D <sup>2</sup> PAK | 1.5  |
|                      |   | TO-220AB insulated            | 2.4  |
| $R_{th(j-a)}$ (max.) | Junction to ambient ( $S^{(1)} = 2\text{ cm}^2$ ) | D <sup>2</sup> PAK            | 45   |
|                      | Junction to ambient                               | TO-220AB / TO-220AB ins       | 60   |

1. Copper surface under tab.

**1.1 Characteristics (curves)**
**Figure 2. Maximum power dissipation versus on-state RMS current (full cycle)**

**Figure 3. RMS on-state current cycle versus case temperature (full cycle)**

**Figure 4. Relative variation of thermal impedance versus pulse duration**

**Figure 5. On-state characteristics (maximum values)**

**Figure 6. Surge peak on-state current versus number of cycles**

**Figure 7. Non repetitive surge peak on-state current versus sinusoidal pulse width (tp < 10 ms)**

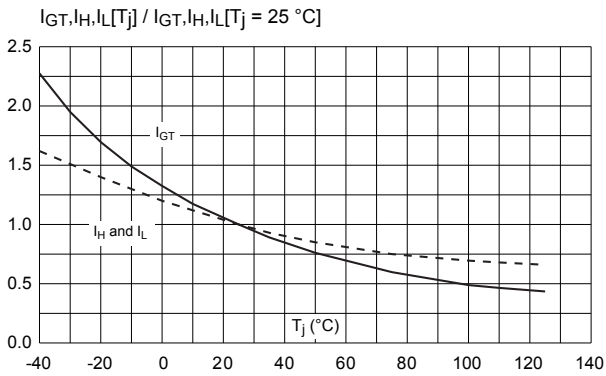
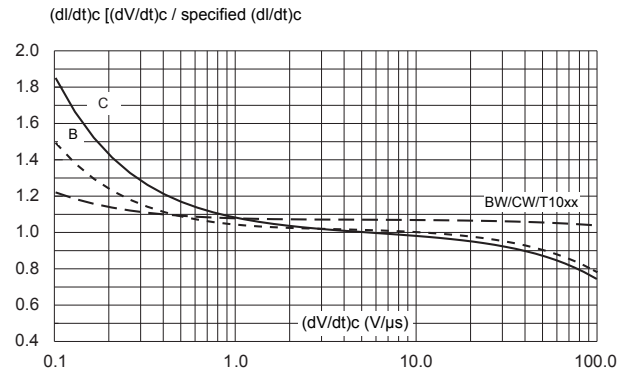
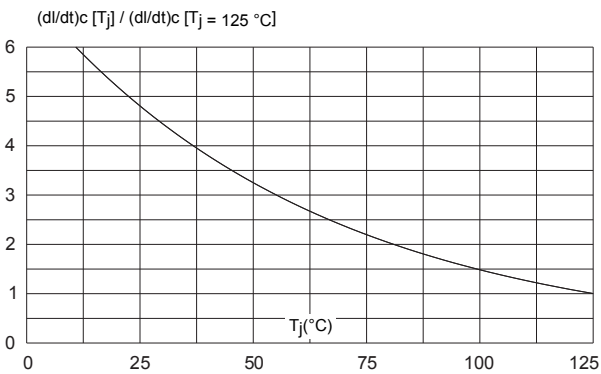
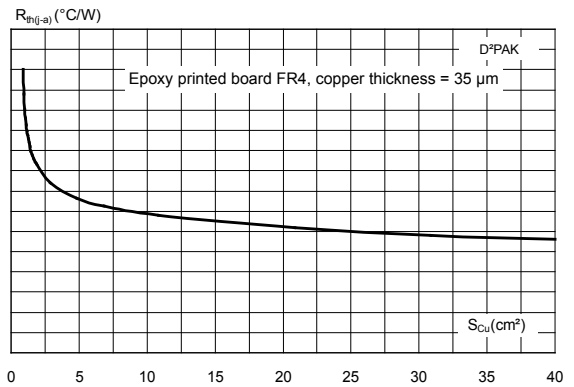
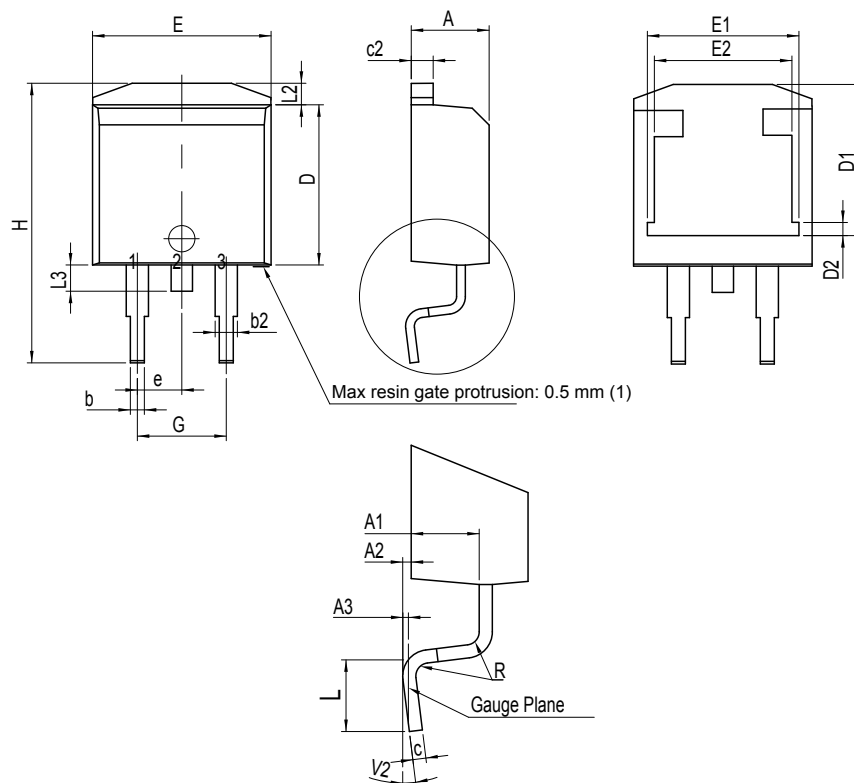

**Figure 8. Relative variation of gate trigger current, holding current and latching current versus junction temperature (typical values)**

**Figure 9. Relative variation of critical rate of decrease of main current versus  $(dV/dt)_c$  (typical values)**

**Figure 10. Relative variation of critical rate of decrease of main current versus junction temperature**

**Figure 11. D<sup>2</sup>PAK thermal resistance junction to ambient versus copper surface under tab**

## 2 Package information

In order to meet environmental requirements, ST offers these devices in different grades of **ECOPACK®** packages, depending on their level of environmental compliance. ECOPACK® specifications, grade definitions and product status are available at: [www.st.com](http://www.st.com). ECOPACK® is an ST trademark.

### 2.1 D<sup>2</sup>PAK package information

**Figure 12. D<sup>2</sup>PAK package outline**



(1) Resin gate is accepted in each of position shown on the drawing, or their symmetrical.

**Table 6. D<sup>2</sup>PAK package mechanical data**

| Ref. | Dimensions  |      |      |                       |        |        |
|------|-------------|------|------|-----------------------|--------|--------|
|      | Millimeters |      |      | Inches <sup>(1)</sup> |        |        |
|      | Min.        | Typ. | Max. | Min.                  | Typ.   | Max.   |
| A    | 4.30        |      | 4.60 | 0.1693                |        | 0.1811 |
| A1   | 2.49        |      | 2.69 | 0.0980                |        | 0.1059 |
| A2   | 0.03        |      | 0.23 | 0.0012                |        | 0.0091 |
| A3   |             | 0.25 |      |                       | 0.0098 |        |
| b    | 0.70        |      | 0.93 | 0.0276                |        | 0.0366 |
| b2   | 1.25        |      | 1.7  | 0.0492                |        | 0.0669 |

| Ref. | Dimensions  |      |       |                       |        |        |
|------|-------------|------|-------|-----------------------|--------|--------|
|      | Millimeters |      |       | Inches <sup>(1)</sup> |        |        |
|      | Min.        | Typ. | Max.  | Min.                  | Typ.   | Max.   |
| c    | 0.45        |      | 0.60  | 0.0177                |        | 0.0236 |
| c2   | 1.21        |      | 1.36  | 0.0476                |        | 0.0535 |
| D    | 8.95        |      | 9.35  | 0.3524                |        | 0.3681 |
| D1   | 7.50        |      | 8.00  | 0.2953                |        | 0.3150 |
| D2   | 1.30        |      | 1.70  | 0.0512                |        | 0.0669 |
| e    | 2.54        |      |       | 0.1                   |        |        |
| E    | 10.00       |      | 10.28 | 0.3937                |        | 0.4047 |
| E1   | 8.30        |      | 8.70  | 0.3268                |        | 0.3425 |
| E2   | 6.85        |      | 7.25  | 0.2697                |        | 0.2854 |
| G    | 4.88        |      | 5.28  | 0.1921                |        | 0.2079 |
| H    | 15          |      | 15.85 | 0.5906                |        | 0.6240 |
| L    | 1.78        |      | 2.28  | 0.0701                |        | 0.0898 |
| L2   | 1.27        |      | 1.40  | 0.0500                |        | 0.0551 |
| L3   | 1.40        |      | 1.75  | 0.0551                |        | 0.0689 |
| R    |             | 0.40 |       |                       | 0.0157 |        |
| V2   | 0°          |      | 8°    | 0°                    |        | 8°     |

1. Dimensions in inches are given for reference only

**Figure 13. D<sup>2</sup>PAK recommended footprint (dimensions are in mm)**

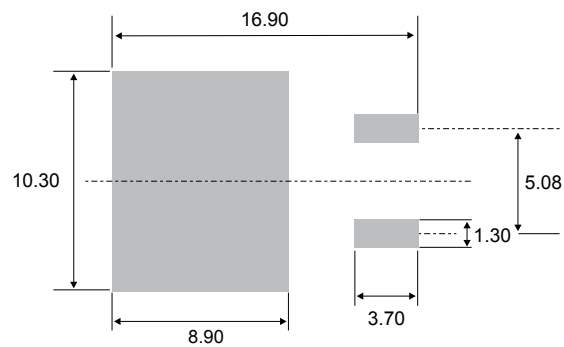

## 2.2 TO-220AB non ins. and insulated package information

Figure 14. TO-220AB non ins. and insulated package outline

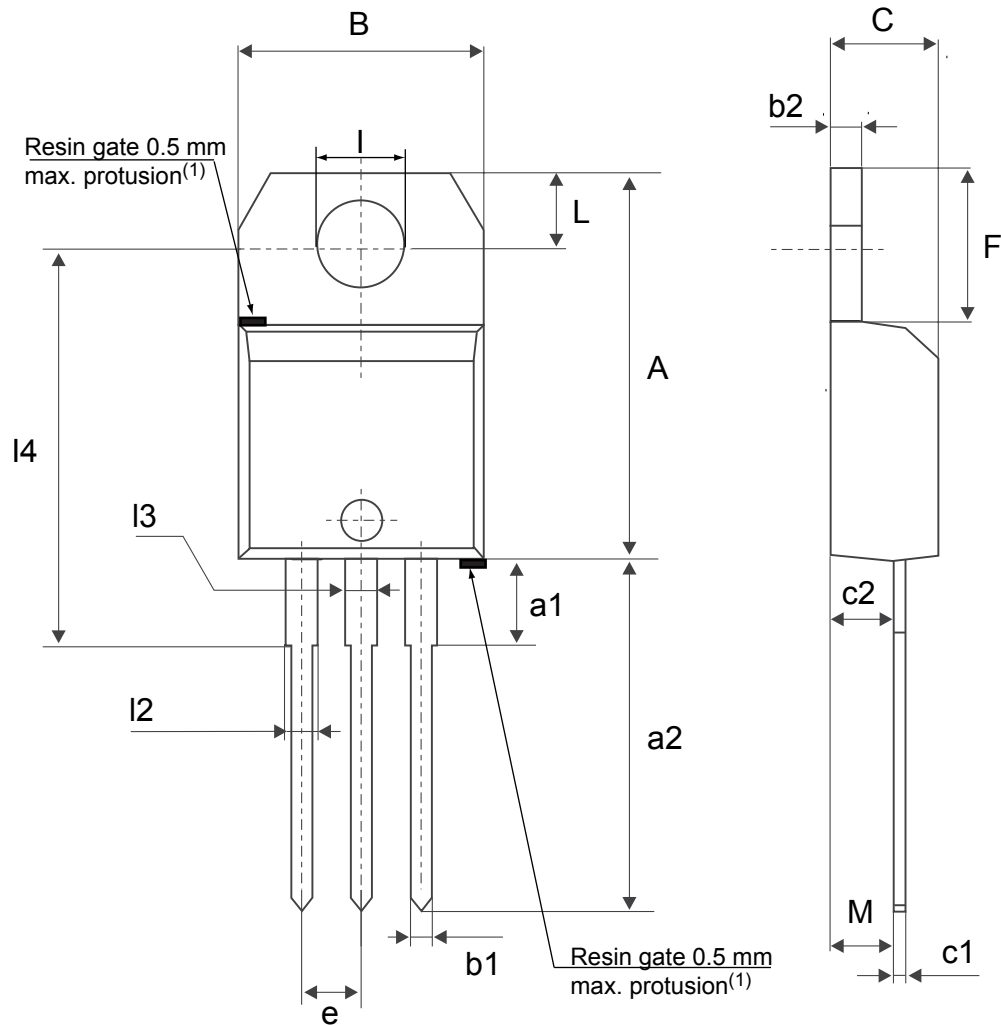

(1) Resin gate position accepted in one of the two positions or in the symmetrical opposites.

Table 7. TO-220AB non ins. and insulated package mechanical data

| Ref. | Dimensions  |      |       |                     |        |        |
|------|-------------|------|-------|---------------------|--------|--------|
|      | Millimeters |      |       | Inches <sup>1</sup> |        |        |
|      | Min.        | Typ. | Max.  | Min.                | Typ.   | Max.   |
| A    | 15.20       |      | 15.90 | 0.5984              |        | 0.6260 |
| a1   |             | 3.75 |       |                     | 0.1476 |        |
| a2   | 13.00       |      | 14.00 | 0.5118              |        | 0.5512 |
| B    | 10.00       |      | 10.40 | 0.3937              |        | 0.4094 |
| b1   | 0.61        |      | 0.88  | 0.0240              |        | 0.0346 |
| b2   | 1.23        |      | 1.32  | 0.0484              |        | 0.0520 |
| C    | 4.40        |      | 4.60  | 0.1732              |        | 0.1811 |



| Ref. | Dimensions  |       |       |                     |        |        |
|------|-------------|-------|-------|---------------------|--------|--------|
|      | Millimeters |       |       | Inches <sup>1</sup> |        |        |
|      | Min.        | Typ.  | Max.  | Min.                | Typ.   | Max.   |
| c1   | 0.49        |       | 0.70  | 0.0193              |        | 0.0276 |
| c2   | 2.40        |       | 2.72  | 0.0945              |        | 0.1071 |
| e    | 2.40        |       | 2.70  | 0.0945              |        | 0.1063 |
| F    | 6.20        |       | 6.60  | 0.2441              |        | 0.2598 |
| l    | 3.73        |       | 3.88  | 0.1469              |        | 0.1528 |
| L    | 2.65        |       | 2.95  | 0.1043              |        | 0.1161 |
| l2   | 1.14        |       | 1.70  | 0.0449              |        | 0.0669 |
| l3   | 1.14        |       | 1.70  | 0.0449              |        | 0.0669 |
| l4   | 15.80       | 16.40 | 16.80 | 0.6220              | 0.6457 | 0.6614 |
| M    |             | 2.6   |       |                     | 0.1024 |        |

1. Inch dimensions are for reference only.

### 3 Ordering information

**Figure 15. BTA10 and BTB10 series ordering information scheme**

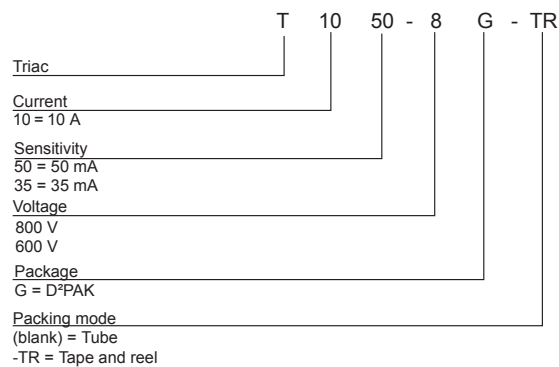
**Figure 16. T10xx series ordering information scheme**

**Table 8. Ordering information**

| Order code    | Marking     | Package            | Weight | Base qty. | Delivery mode     |
|---------------|-------------|--------------------|--------|-----------|-------------------|
| BTA10-600BRG  | BTA10-600B  | TO-220AB Ins.      | 2.3 g  | 50        | Tube              |
| BTA10-600CRG  | BTA10-600C  |                    |        |           |                   |
| BTA10-600BWRG | BTA10-600BW |                    |        |           |                   |
| BTA10-600CWRG | BTA10-600CW |                    |        |           |                   |
| BTA10-800BWRG | BTA10-800BW |                    |        |           |                   |
| BTA10-800CWRG | BTA10-800CW |                    |        |           |                   |
| BTB10-600BWRG | BTB10-600BW | TO-220AB           |        |           |                   |
| BTB10-800BWRG | BTB10-800BW |                    |        |           |                   |
| T1035-6G      | T1035-6G    | D <sup>2</sup> PAK | 1.50 g |           | Tape and reel 13" |
| T1050-8G      | T1050-8G    |                    |        |           |                   |
| T1035-6G-TR   | T1035-6G    |                    |        | 1000      |                   |
| T1050-8G-TR   | T1050-8G    |                    |        |           |                   |

## Revision history

**Table 9. Document revision history**

| Date        | Revision | Changes  |
|-------------|----------|--|
| Sep-2002    | 5A       | Last update.   |
| 13-Feb-2006 | 6        | TO-220AB delivery mode changed from bulk to tube. ECOPACK statement added.   |
| 06-Feb-2017 | 7        | Added D <sup>2</sup> PAK package information.  |
| 15-Mar-2018 | 8        | Updated Table 3. Electrical characteristics (T <sub>J</sub> = 25 °C, unless otherwise specified) - Snubberless™ (3 quadrants), Section 3 Ordering information and Section 2.1 D <sup>2</sup> PAK package information.<br>Added RPNs T1035 and T1050. |
| 01-Mar-2019 | 9        | Updated Links syntax.  |