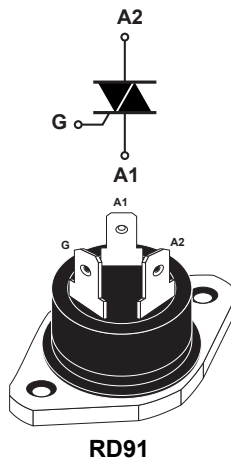


## 800 V and 600 V, 25 A standard Triacs in RD91 package



### Features

- High current Triac
- Low thermal resistance with clip bonding
- High commutation (4 quadrants) or very high commutation (3 quadrants) capability
- UL1557 recognized components (file ref: 81734)
- RoHS (2002/95/EC) compliant packages

### Applications

- On/off function in static relays, heating regulation, induction motor starting circuits
- Phase control operations in light dimmers and motor speed controllers

### Description

Available in the Faston terminal RD91 package, the BTA25 is suitable for general purpose AC switching and provides an insulated tab (rated at 2500  $V_{RMS}$ ). Representative samples of these components have been evaluated by UL and meet applicable UL requirements for UL 1557 standard (file ref. 81734).



#### Product status link

<a href="#">BTA25</a>	RD91 insulated package
-----------------------	------------------------

#### Product summary

$I_{T(RMS)}$	25 A
$V_{DRM}/V_{RRM}$	600 V to 800 V
$I_{GT}$	50 mA

# 1 Characteristics

**Table 1. Absolute maximum ratings**

Symbol	Parameters			Value	Unit
$I_{T(RMS)}$	RMS on-state current (180° conduction angle)		$T_c = 100\text{ °C}$	25	A
$I_{TSM}$	Non repetitive surge peak on-state current (full cycle, $T_j$ initial = 25 °C)	f = 60 Hz	$t_p = 16,7\text{ ms}$	260	A
		f = 50 Hz	$t_p = 20\text{ ms}$	250	
$I^2t$	$I^2t$ value for fusing		$t_p = 10\text{ ms}$	340	A <sup>2</sup> s
$di/dt$	Critical rate of rise of on-state current $I_G = 2 \times I_{GT}$ , $t_r \leq 100\text{ ns}$		f = 120 Hz $T_j = 125\text{ °C}$	50	A/ $\mu$ s
$V_{DRM}$ , $V_{RRM}$	Repetitive peak off-state voltage		$T_j = 125\text{ °C}$	600 and 800	V
$V_{DSM}$ , $V_{RSM}$	Non repetitive surge peak off-state voltage		$t_p = 20\text{ ms}$ $T_j = 25\text{ °C}$	$V_{DRM}$ , $V_{RRM}$ + 100	V
$I_{GM}$	Peak gate current		$t_p = 20\text{ }\mu$ s $T_j = 125\text{ °C}$	4	A
$P_{G(AV)}$	Average gate power dissipation		$T_j = 125\text{ °C}$	1	W
$T_{stg}$	Storage junction temperature range				-40 to +150 °C
$T_j$	Operating junction temperature range				-40 to +125 °C
$V_{INS}$	Insulation RMS voltage, 1 minute				2500 V

**Table 2. Electrical characteristics ( $T_j = 25\text{ °C}$ , unless otherwise specified) - Snubberless (3 quadrants)**

Symbol	Parameters	Quadrant		Value	Unit
$I_{GT}^{(1)}$	$V_D = 12\text{ V}$ , $R_L = 33\text{ }\Omega$	I - II - III	Max.	50	mA
$V_{GT}$		I - II - III	Max.	1.3	
$V_{GD}$	$V_D = V_{DRM}$ , $R_L = 3.3\text{ k}\Omega$ , $T_j = 125\text{ °C}$	I - II - III	Min.	0.2	V
$I_H^{(2)}$	$I_T = 500\text{ mA}$			Max.	75 mA
$I_L$	$I_G = 1.2 I_{GT}$	I - III	Max.	80	mA
		II	Max.	100	
$dV/dt^{(2)}$	$V_D = 67\% V_{DRM}$ gate open, $T_j = 125\text{ °C}$			Min.	1000 V/ $\mu$ s
$(di/dt)_c^{(2)}$	Without snubber, $T_j = 125\text{ °C}$			Min.	22 A/ms

1. Minimum  $I_{GT}$  is guaranteed at 5 % of  $I_{GT}$  max.
2. For both polarities of A2 referenced to A1

**Table 3. Electrical characteristics ( $T_j = 25\text{ }^\circ\text{C}$ , unless otherwise specified) - standard (4 quadrants)**

Symbol	Parameters	Quadrant		Value	Unit
$I_{GT}^{(1)}$	$V_D = 12\text{ V}, R_L = 33\ \Omega$	I - II - III IV	Max.	50 100	mA
$V_{GT}$		All	Max.	1.3	V
$V_{GD}$	$V_D = V_{DRM}, R_L = 3.3\text{ k}\Omega, T_j = 125\text{ }^\circ\text{C}$	All	Min.	0.2	V
$I_H^{(2)}$	$I_T = 500\text{ mA}$		Max.	80	mA
$I_L$	$I_G = 1.2\ I_{GT}$	I - III - IV	Max.	70	mA
		II	Max.	160	
$dV/dt^{(2)}$	$V_D = 67\% V_{DRM}$ gate open, $T_j = 125\text{ }^\circ\text{C}$		Min.	500	V/ $\mu\text{s}$
$(dV/dt)_c^{(2)}$	$(dI/dt)_c = 13.3\text{ A/ms}, T_j = 125\text{ }^\circ\text{C}$		Min.	10	V/ $\mu\text{s}$

1. Minimum  $I_{GT}$  is guaranteed at 5 % of  $I_{GT}$  max.
2. For both polarities of A2 referenced to A1

**Table 4. Static electrical characteristics**

Symbol	Test conditions	$T_j$		Value	Unit
$V_{TM}^{(1)}$	$I_{TM} = 35\text{ A}, t_p = 380\ \mu\text{s}$	$25\text{ }^\circ\text{C}$	Max.	1.55	V
$V_{TO}^{(1)}$	threshold on-state voltage	$125\text{ }^\circ\text{C}$	Max.	0.85	V
$R_D^{(1)}$	Dynamic resistance	$125\text{ }^\circ\text{C}$	Max.	16	m $\Omega$
$I_{DRM}/I_{RRM}$	$V_T = V_{DRM}, V_T = V_{RRM}$	$25\text{ }^\circ\text{C}$	Max.	5	$\mu\text{A}$
		$125\text{ }^\circ\text{C}$		3	mA

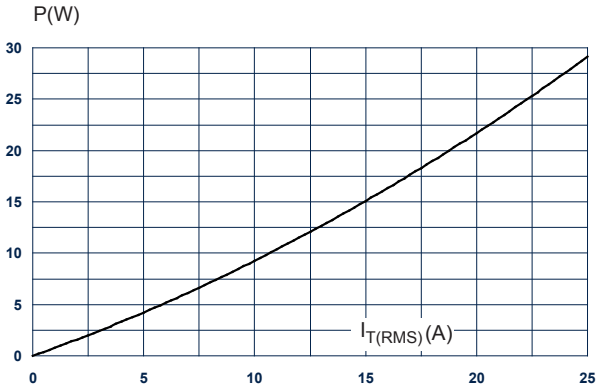
1. For both polarities of A2 referenced to A1

**Table 5. Thermal resistance**

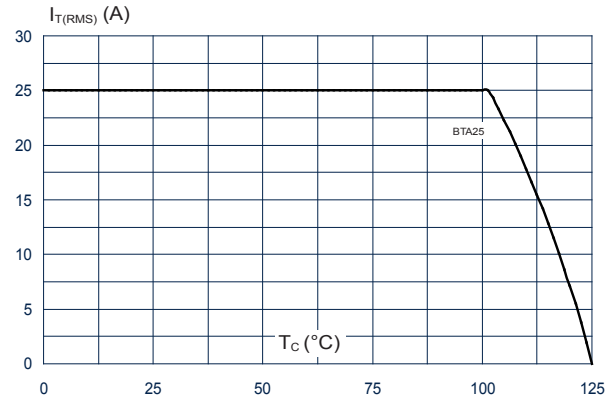
Symbol	Parameters		Value	Unit
$R_{th(j-c)}$	Junction to case (AC)	Max.	0.9	$^\circ\text{C/W}$

### 1.1 Characteristics (curves)

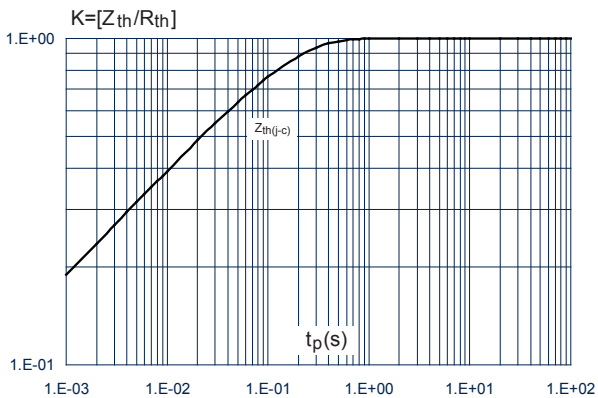
**Figure 1. Maximum power dissipation versus on-state RMS current (full cycle)**



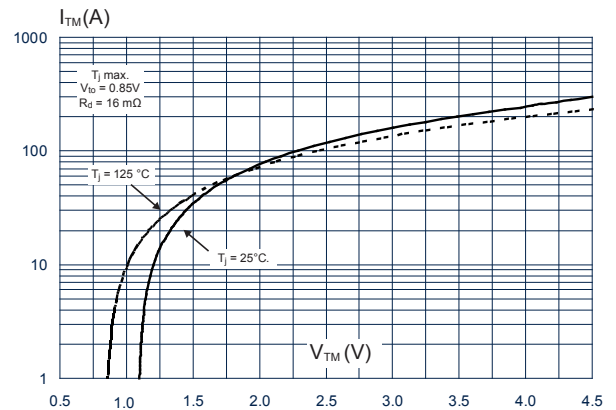
**Figure 2. RMS on-state current versus case temperature (full cycle)**



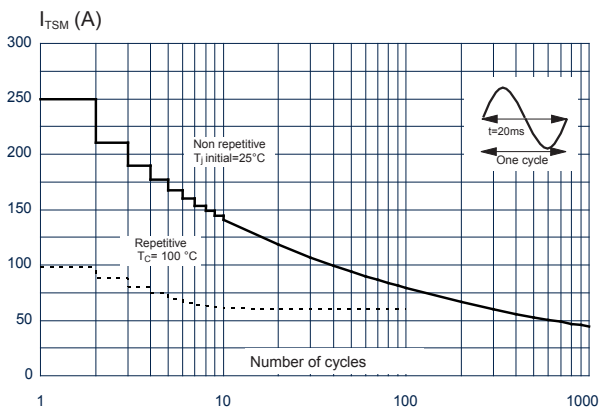
**Figure 3. Relative variation of thermal impedance versus pulse duration**



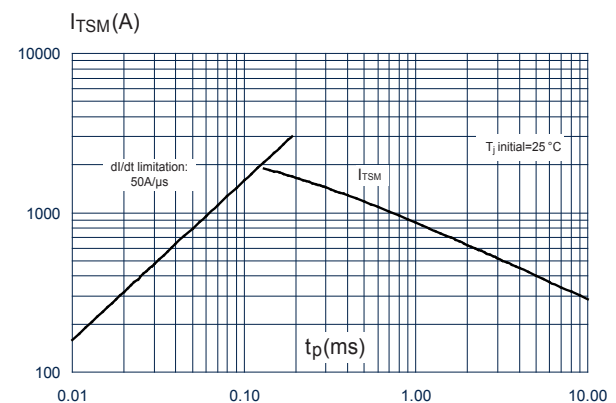
**Figure 4. On-state characteristics (maximum values)**

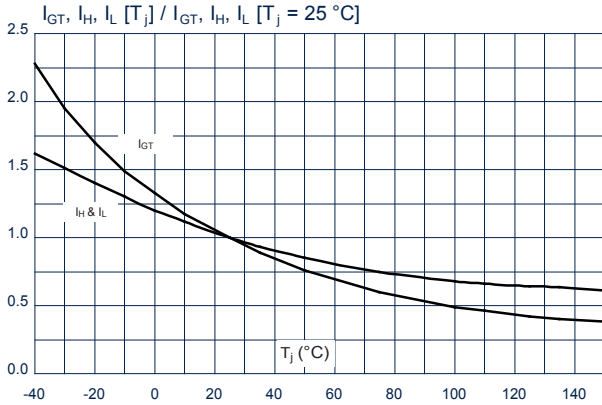
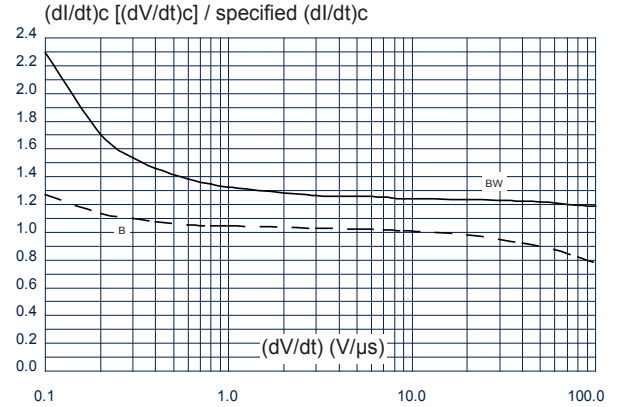
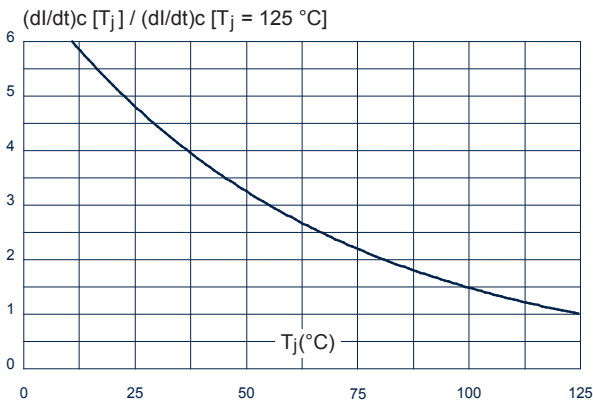
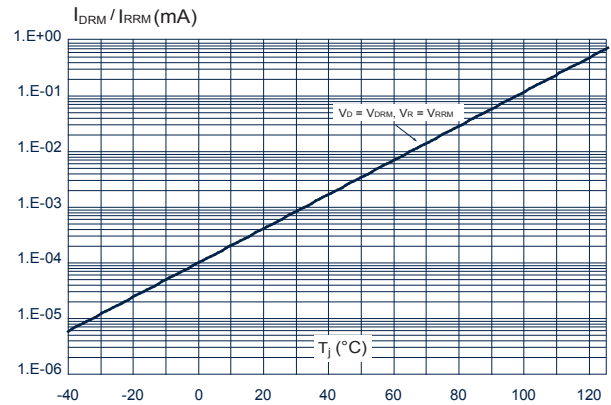


**Figure 5. Surge peak on-state current versus number of cycles**



**Figure 6. Non-repetitive surge peak on-state current for a sinusoidal pulse with width  $t_p < 10\text{ms}$**



**Figure 7. Relative variation of gate trigger current, holding and latching current versus junction temperature (typical values)**

**Figure 8. Relative variation of critical rate of decrease of main current versus (dV/dt) (typical values)**

**Figure 9. Relative variation of critical rate of decrease of main current versus junction temperature**

**Figure 10. Leakage current versus junction temperature for different values of blocking voltage (typical values)**


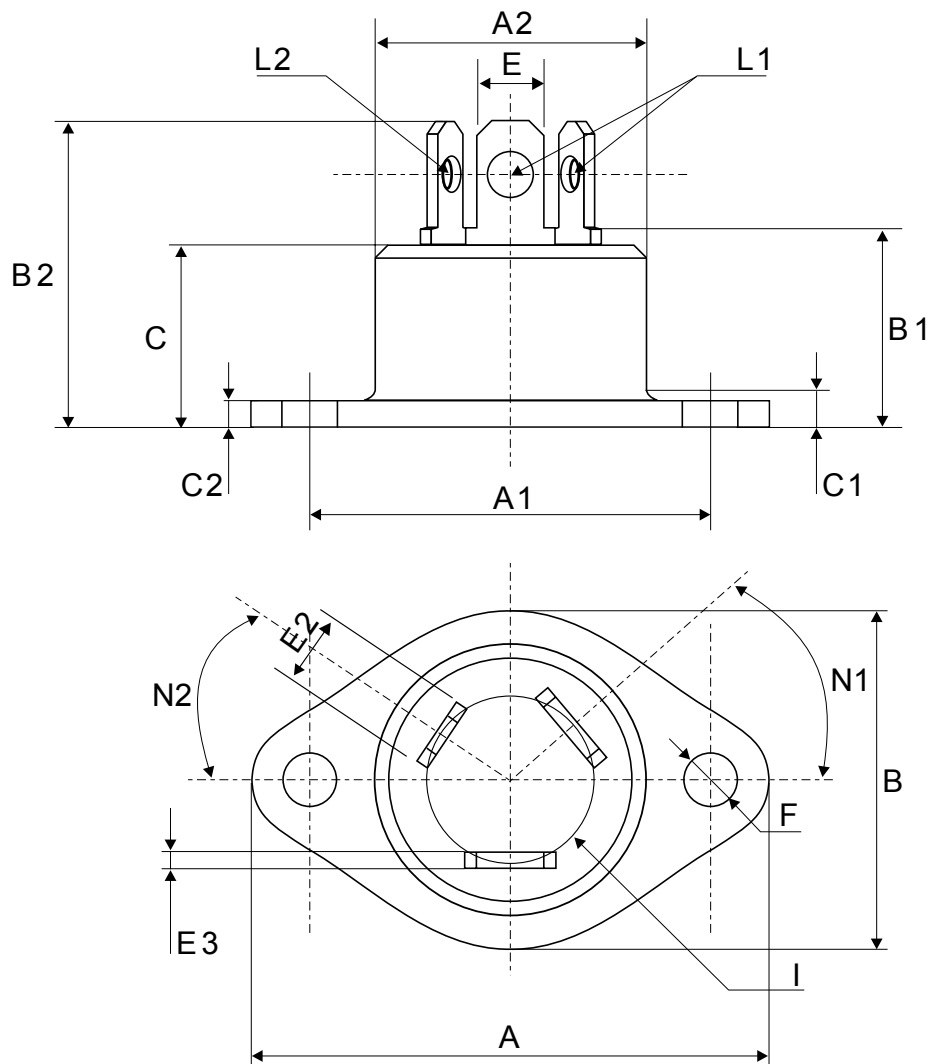
## 2 Package information

In order to meet environmental requirements, ST offers these devices in different grades of **ECOPACK** packages, depending on their level of environmental compliance. ECOPACK specifications, grade definitions and product status are available at: [www.st.com](http://www.st.com). ECOPACK is an ST trademark.

### 2.1 RD91 package information

- Epoxy meets UL94, V0
- Cooling method: Conduction
- Recommended torque: 0.9 to 1.2 N·m

**Figure 11. RD91 package outline**



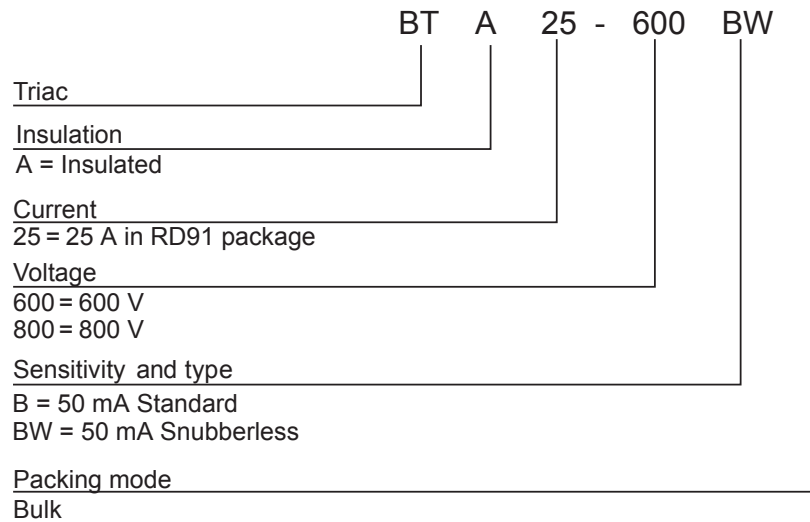
**Table 6. RD91 mechanical data**

Ref.	Dimensions					
	mm			Inches <sup>(1)</sup>		
	Min.	Typ.	Max.	Min.	Typ.	Max.
A			40.00			1.575
A1	30.10		30.30	1.185		1.193
A2			22.00			0.867
B			27.00			1.063
B1	13.50		16.50	0.531		0.650
B2			24.00			0.945
C			14.00			0.552
C1			3.50			0.138
C2	1.90		2.10	0.074		0.083
E	6.10		6.50	0.240		0.256
E2	4.80		5.20	0.188		0.205
E3	0.70		0.90	0.027		0.036
F	4.00		4.30	0.157		0.170
I	11.20		11.60	0.440		0.536
L1	3.10		3.50	0.122		0.138
L2	1.70		1.90	0.066		0.075
N1	33°		43°	33°		43°
N2	28°		38°	28°		38°

1. Inches given for reference only

### 3 Ordering information

**Figure 12. Ordering information scheme**



**Table 7. Ordering information**

Order code	Marking	Package	Weight	Base qty.	Delivery mode
BTA25-600B	BTA25600B	RD91	20 g	25	Bulk
BTA25-600BW	BTA25600BW				
BTA25-800B	BTA25800B				
BTA25-800BW	BTA25800BW				



## Revision history

**Table 8. Document revision history**

Date	Revision	Changes
03-Aug-2021	1	Initial release.