

## 800 V and 600 V, 25 A standard Triacs in TOP3 package

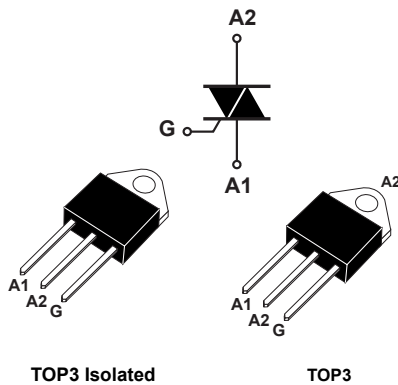

### Features

- High current Triac
- Low thermal resistance with clip bonding
- Standard commutation (4 quadrants) or snubberless (3 quadrants), both with high turn-off commutation
- BTA26 UL1557 recognized components (file ref: 81734)
- RoHS (2002/95/EC) compliant packages

### Applications

- On/off function in static relays, heating regulation, induction motor starting circuits
- Phase control operations in light dimmers and motor speed controllers

### Description

Available in TOP3 insulated and non-insulated package, BTA26 and BTB26 are suitable for general purpose AC switching.

BTA26 and BTB26 provide an insulated tab (rated at 2500 V<sub>RMS</sub>). These components are UL recognized and meet UL 1557 (file ref. 81734).



Product status link	
BTA26	TOP3 isolated package
BTB26	TOP3 package

Product summary	
$I_{T(RMS)}$	25 A
$V_{DRM}/V_{RRM}$	600 V to 800 V
$I_{GT(standard)}$	50 mA
$I_{GT(Snubberless)}$ BTA26 <sup>(1)</sup>	35 / 50 mA

1. 600 V version available only with  $I_{GT} = 50$  mA (Snubberless and Standard)

# 1 Characteristics

**Table 1. Absolute maximum ratings**

Symbol	Parameters	Value	Unit	
$I_{T(RMS)}$	RMS on-state current (180° conduction angle)	BTA26 (TOP3 Ins.) $T_c = 100\text{ °C}$	25	A
		BTB26 (TOP3) $T_c = 105\text{ °C}$		
$I_{TSM}$	Non repetitive surge peak on-state current (full cycle, $T_j$ initial = 25 °C)	f = 60 Hz $t_p = 16,7\text{ ms}$	260	A
		f = 50 Hz $t_p = 20\text{ ms}$	250	
$I^2t$	$I^2t$ value for fusing	$t_p = 10\text{ ms}$	340	A <sup>2</sup> s
$di/dt$	Critical rate of rise of on-state current $I_G = 2 \times I_{GT}$ , $t_r \leq 100\text{ ns}$	f = 120 Hz $T_j = 125\text{ °C}$	50	A/ $\mu$ s
$V_{DSM}, V_{RSM}$	Non repetitive surge peak off-state voltage	$t_p = 20\text{ ms}$ $T_j = 25\text{ °C}$	$V_{DRM}, V_{RRM} + 100$	V
$I_{GM}$	Peak gate current	$t_p = 20\text{ }\mu$ s $T_j = 125\text{ °C}$	4	A
$P_{G(AV)}$	Average gate power dissipation	$T_j = 125\text{ °C}$	1	W
$T_{stg}$	Storage junction temperature range		-40 to +150	°C
$T_j$	Operating junction temperature range		-40 to +125	°C
$T_L$	Maximum lead temperature for soldering during 10 s		250	°C
$V_{INS}$	Insulation RMS voltage, 1 minute		2500	V

**Table 2. Electrical characteristics ( $T_j = 25\text{ °C}$ , unless otherwise specified) - Snubberless and Standard (3 quadrants)**

Symbol	Parameters	Quadrant		BTA/BTB		Unit
				CW	BW	
$I_{GT}^{(1)}$	$V_D = 12\text{ V}, R_L = 33\text{ }\Omega$	I - II - III	Max.	35	50	mA
$V_{GT}$		I - II - III	Max.	1.3		V
$V_{GD}$	$V_D = V_{DRM}, R_L = 3.3\text{ k}\Omega, T_j = 125\text{ °C}$	I - II - III	Min.	0.2		V
$I_H^{(2)}$	$I_T = 500\text{ mA}$		Max.	50	75	mA
$I_L$	$I_G = 1.2 I_{GT}$	I - III	Max.	70	80	mA
		II	Max.	80	100	
$dV/dt^{(2)}$	$V_D = 67\% V_{DRM}$ gate open, $T_j = 125\text{ °C}$		Min.	500	1000	V/ $\mu$ s
$(di/dt)_c^{(2)}$	$(di/dt)_c = 20\text{ A/ms}$ , without snubber at $T_j = 125\text{ °C}$		Min.	13	22	A/ms

1. Minimum  $I_{GT}$  is guaranteed at 5 % of  $I_{GT}$  max.
2. For both polarities of A2 referenced to A1

**Table 3. Electrical characteristics ( $T_j = 25\text{ }^\circ\text{C}$ , unless otherwise specified) - Standard (4 quadrants)**

Symbol	Parameters	Quadrant		Value	Unit
$I_{GT}^{(1)}$	$V_D = 12\text{ V}$ , $R_L = 33\ \Omega$	I - II - III IV	Max.	50	mA
$V_{GT}$				100	
$V_{GD}$	$V_D = V_{DRM}$ , $R_L = 3.3\text{ k}\Omega$ , $T_j = 125\text{ }^\circ\text{C}$	All	Max.	1.3	V
$I_H^{(2)}$	$I_T = 500\text{ mA}$	All	Min.	0.2	V
$I_L$	$I_G = 1.2\ I_{GT}$	I - III - IV	Max.	70	mA
		II	Max.	160	
$dV/dt^{(2)}$	$V_D = 67\% V_{DRM}$ gate open, $T_j = 125\text{ }^\circ\text{C}$		Min.	500	V/ $\mu\text{s}$
$(dI/dt)_c^{(2)}$	$(dI/dt)_c = 13.3\text{ A/ms}$ , $T_j = 125\text{ }^\circ\text{C}$		Min.	10	V/ $\mu\text{s}$

1. Minimum  $I_{GT}$  is guaranteed at 5 % of  $I_{GT}$  max.
2. For both polarities of A2 referenced to A1

**Table 4. Static electrical characteristics**

Symbol	Test conditions	$T_j$		Value	Unit
$V_{TM}^{(1)}$	$I_{TM} = 35\text{ A}$ , $t_p = 380\ \mu\text{s}$	$25\text{ }^\circ\text{C}$	Max.	1.55	V
$V_{TO}^{(1)}$	threshold on-state voltage	$125\text{ }^\circ\text{C}$	Max.	0.85	V
$R_D^{(1)}$	Dynamic resistance	$125\text{ }^\circ\text{C}$	Max.	16	m $\Omega$
$I_{DRM}/I_{RRM}$	$V_T = V_{DRM}$ , $V_T = V_{RRM}$	$25\text{ }^\circ\text{C}$	Max.	5	$\mu\text{A}$
		$125\text{ }^\circ\text{C}$		3	mA

1. For both polarities of A2 referenced to A1

**Table 5. Thermal resistance**

Symbol	Parameters			Value	Unit
$R_{th(j-c)}$	Junction to case (AC)	BTA26 (TOP3 Ins.)	Max.	0.9	$^\circ\text{C/W}$
		BTB26 (TOP3)		0.6	
$R_{th(j-a)}$	Junction to ambient	BTA26 (TOP3 Ins.) / BTB26 (TOP3)	Typ.	50	

### 1.1 Characteristics (curves)

**Figure 1. Maximum power dissipation versus on-state RMS current (full cycle)**

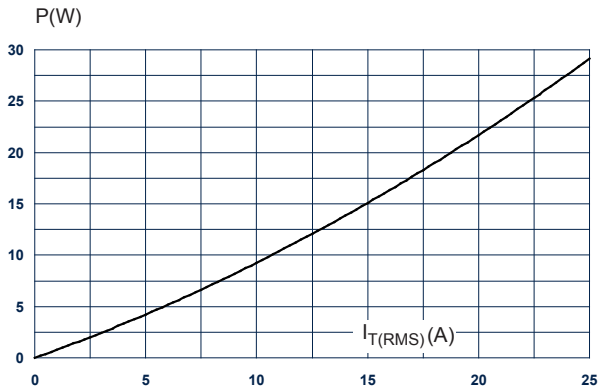

**Figure 2. RMS on-state current versus case temperature (full cycle)**

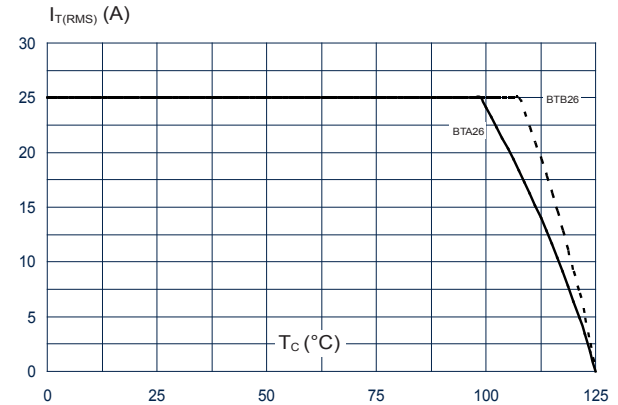

**Figure 3. Relative variation of thermal impedance versus pulse duration**

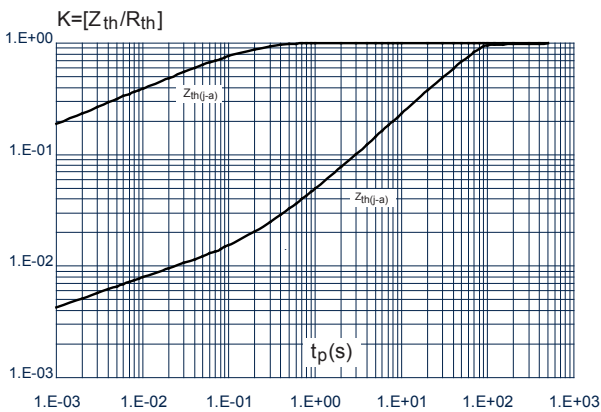

**Figure 4. On-state characteristics (maximum values)**

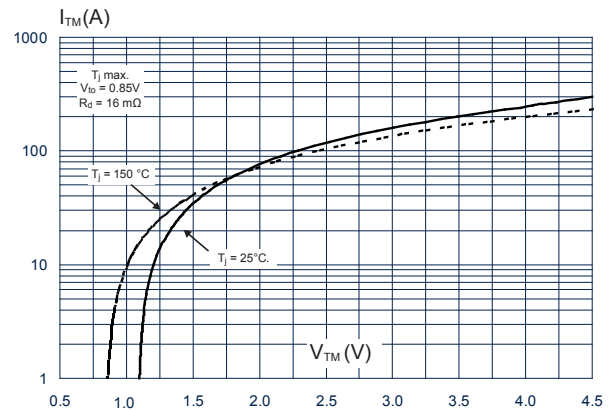

**Figure 5. Surge peak on-state current versus number of cycles**

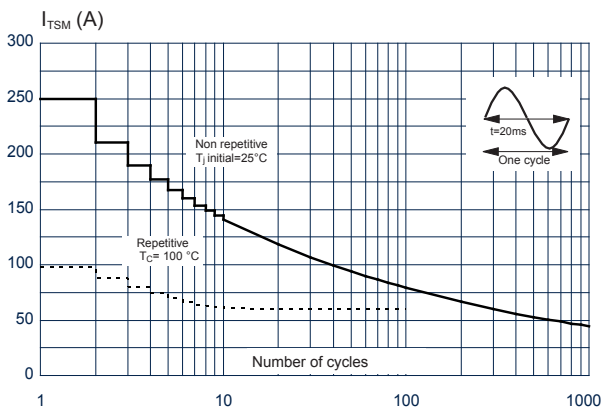

**Figure 6. Non-repetitive surge peak on-state current for a sinusoidal pulse with width  $t_p < 10$  ms**

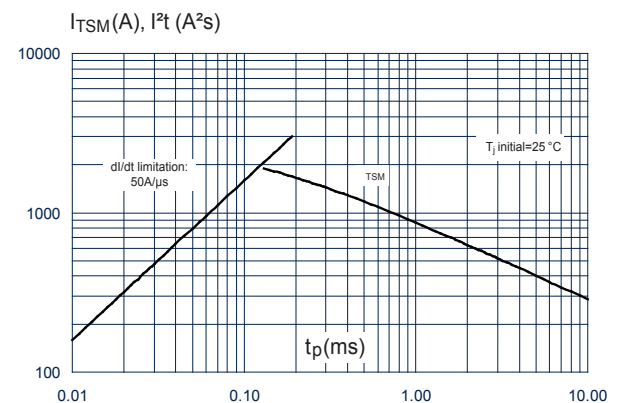

**Figure 7. Relative variation of gate trigger current, holding and latching current versus junction temperature (typical values)**

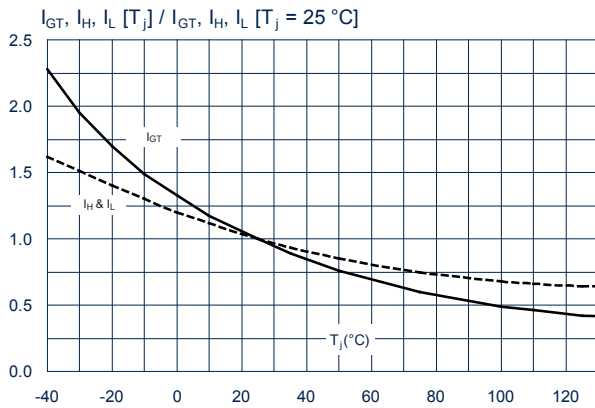

**Figure 8. Relative variation of critical rate of decrease of main current versus (dV/dt) (typical values)**

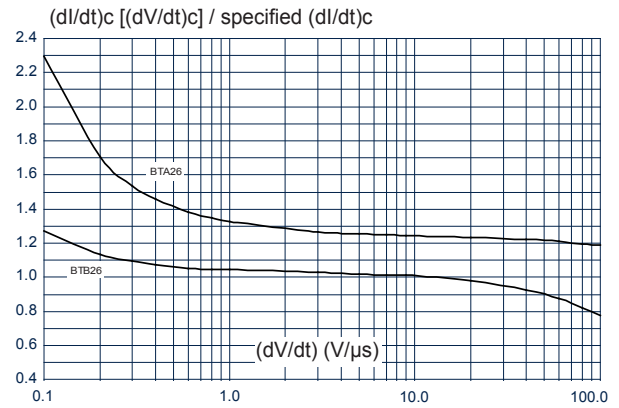

**Figure 9. Relative variation of critical rate of decrease of main current versus junction temperature**

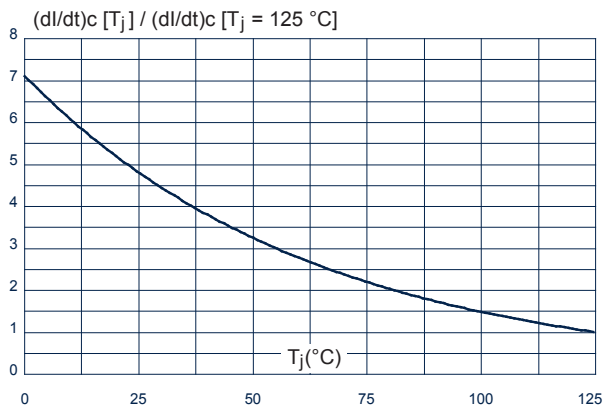

**Figure 10. Relative variation of leakage current versus junction temperature for different values of blocking voltage**

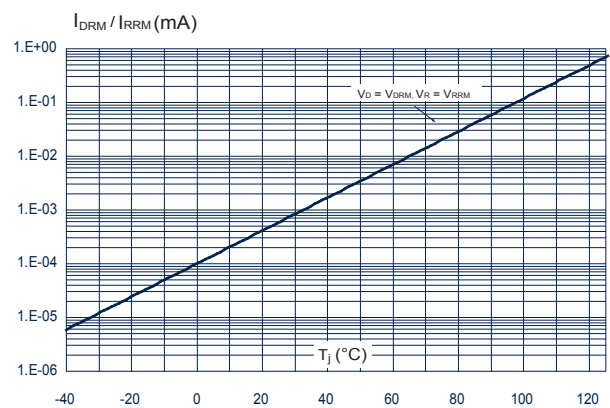

## 2 Package information

In order to meet environmental requirements, ST offers these devices in different grades of **ECOPACK** packages, depending on their level of environmental compliance. ECOPACK specifications, grade definitions and product status are available at: [www.st.com](http://www.st.com). ECOPACK is an ST trademark.

### 2.1 TOP3 insulated and non-insulated package information

- Epoxy meets UL94, V0
- Lead-free packages
- Recommended torque: 1.05 N·m (max. torque: 1.2 N·m)

Figure 11. TOP3 insulated and non-insulated package outline

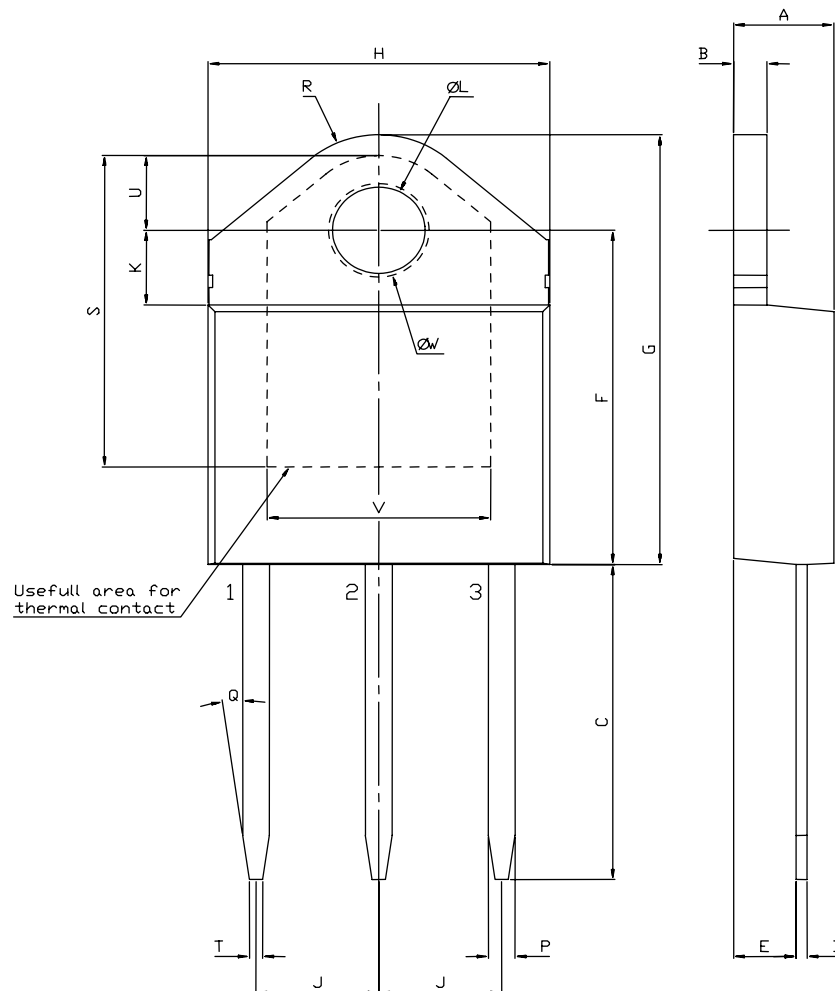

**Table 6. TOP3 insulated and non-insulated mechanical data**

Ref.	Dimensions					
	mm			Inches <sup>(1)</sup>		
	Min.	Typ.	Max.	Min.	Typ.	Max.
A	4.40		4.60	0.1732		0.1812
B	1.45		1.55	0.0570		0.0611
C	14.35		15.60	0.5649		0.6142
D	0.50		0.70	0.0196		0.0276
E	2.70		2.90	0.1062		0.1142
F	15.80		16.50	0.6220		0.6497
G	20.40		21.10	0.8031		0.8308
H	15.10		15.50	0.5944		0.6103
J	5.40		5.65	0.2125		0.2225
K	3.40		3.65	0.1338		0.1438
L	4.08		4.17	0.1606		0.1642
M	1.20		1.40	0.0472		0.0552
R		4.60			0.1811	

1. Inches given for reference only

### 3 Ordering information

Figure 12. Ordering information scheme (BTA26 and BTB26)

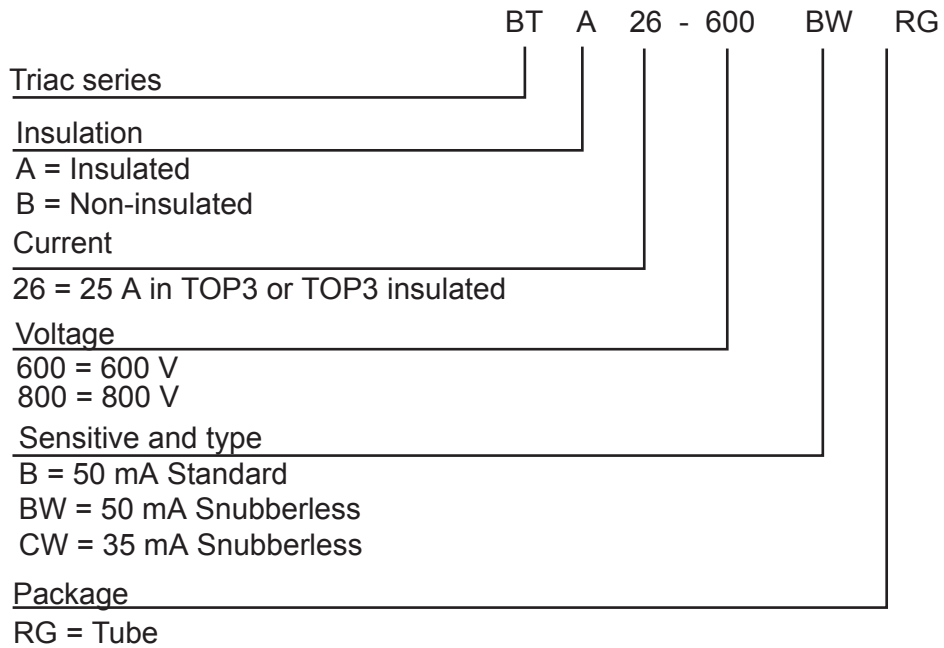

Table 7. Ordering information

Order code	Marking	Package	Weight	Base qty.	Delivery mode
BTA26-600BRG	BTA26600B	TOP3 Ins.	4.5 g	30	Tube
BTA26-600BWRG	BTA26600BW				
BTA26-800BRG	BTA26800B				
BTB26-800BWRG	BTB26800BW	TOP3			
BTB26-800CWRG	BTB26800CW				
BTB26-600BRG	BTB26600B				



## Revision history

**Table 8. Document revision history**

Date	Revision	Changes
03-Aug-2021	1	Initial release.