

50 A, 1000 V SCR thyristor in RD91

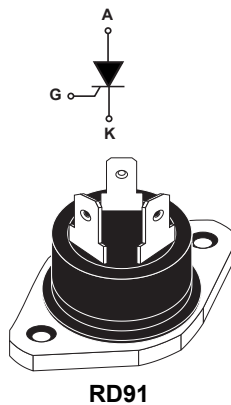

Features

- High current SCR
- High commutation capability
- Low thermal resistance with clip bonding
- Insulated package RD91 high power:
 - Low thermal resistance with clip bonding
 - Insulated voltage: 2500 V_{RMS}
 - Complies with UL 1557 (File ref : E81734)
- RoHS (2002/95/EC) compliant

Applications

- Solid state relays
- Welding equipment
- High power motor control

Description

Available in 2500 V insulated high power package, the 50 A and 1000 V SCR BTW67 is suitable in applications where power handling and power dissipation are critical, such as solid state relays, welding equipment and high power motor control.

Based on a clip assembly technology, they offer a superior performance in surge current handling capabilities.

Product status link

[BTW67](#)

Product summary

$I_{T(RMS)}$	50 A
V_{DRM}/V_{RRM}	1000 V
I_{GT}	80 mA

1 Characteristics

Table 1. Absolute maximum ratings

Symbol	Parameters		Value	Unit	
$I_{T(RMS)}$	RMS on-state current (full sine wave)		$T_c = 70\text{ °C}$	50	A
$I_{T(AV)}$	Average on-state current (180° conduction angle)		$T_c = 70\text{ °C}$	32	A
I_{TSM}	Non repetitive surge peak on-state current (full cycle, T_j initial = 25 °C)		$t_p = 8.3\text{ ms}$	610	A
I^2t	I^2t value for fusing	$t_p = 10\text{ ms}$		1680	A ² s
di/dt	Critical rate of rise of on-state current $I_G = 2 \times I_{GT}$, $t_r \leq 100\text{ ns}$	$F = 60\text{ Hz}$	$T_j = 125\text{ °C}$	50	A/ μ s
I_{GM}	Peak gate current	$t_p = 20\text{ }\mu$ s	$T_j = 125\text{ °C}$	8	A
$P_{G(AV)}$	Average gate power dissipation		$T_j = 125\text{ °C}$	1	W
T_{stg}	Storage junction temperature range			-40 to +150	°C
T_j	Operating junction temperature range			-40 to +125	°C
V_{GRM}	Maximum peak reverse gate voltage			5	V
V_{ins}	Insulation RMS voltage, 1 minute			2500	V

Table 2. Electrical characteristics ($T_j = 25\text{ °C}$, unless otherwise specified)

Symbol	Test conditions	T_j		Value	Unit
I_{GT}	$V_D = 12\text{ V}$, $R_L = 33\text{ }\Omega$	25 °C	Min.	8	mA
			Max	80	
V_{GT}			Max	1.3	V
V_{GD}	$V_D = V_{DRM}$, $R_L = 3.3\text{ k}\Omega$	125 °C	Min.	0.2	V
I_H	$I_T = 500\text{ mA}$, gate open		Max.	150	mA
I_L	$I_G = 1.2 \times I_{GT}$		Max.	200	mA
dV/dt	$V_D = 67\%$, V_{DRM} gate open	125 °C	Min.	1000	V/ μ s
V_{TM}	$I_{TM} = 100\text{ A}$, $t_p = 380\text{ }\mu$ s	25 °C	Max.	1.9	V
V_{TO}	threshold on-state voltage	125 °C	Max.	1.0	V
R_D	Dynamic resistance	125 °C	Max.	8.5	m Ω
I_{DRM}/I_{RRM}	$V_D = V_{DRM}$, $V_R = V_{RRM}$	25 °C	Max.	10	μ A
		125 °C		5	mA

Table 3. Thermal resistance

Symbol	Parameters	Value	Unit
$R_{th(j-c)}$	Junction to case (D.C)	1.0	°C/W

1.1 Characteristics curves

Figure 1. Maximum average power dissipation versus average on-state current

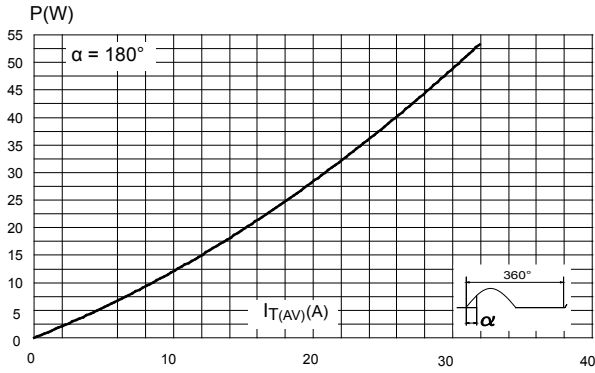

Figure 2. Average on-state current versus case temperature

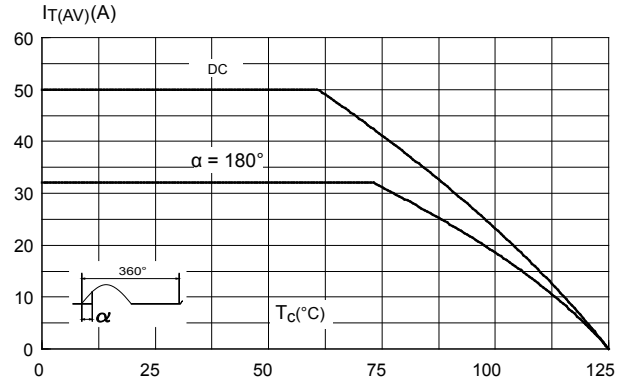

Figure 3. Relative variation of thermal impedance versus pulse duration

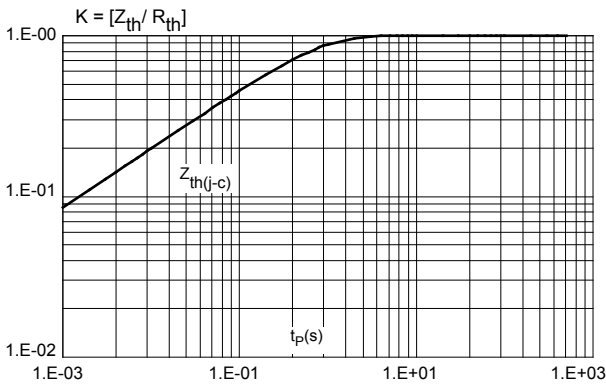

Figure 4. Relative variation of gate trigger current, holding current and latching current versus junction temperature

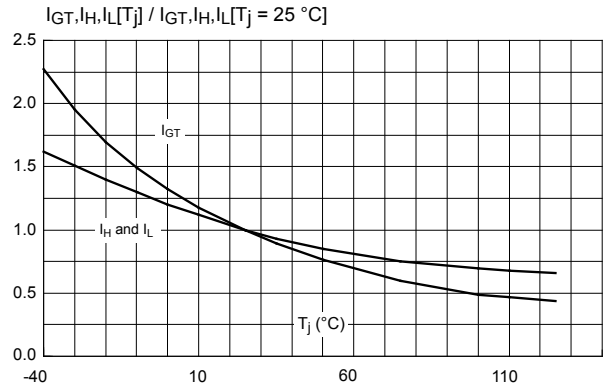

Figure 5. Surge peak on-state current versus number of cycles

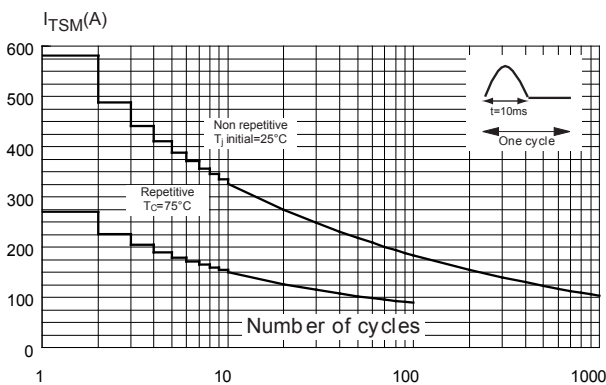

Figure 6. Non repetitive surge peak on-state current for a sinusoidal pulse with width $t_p < 10ms$, and corresponding value of I^2t

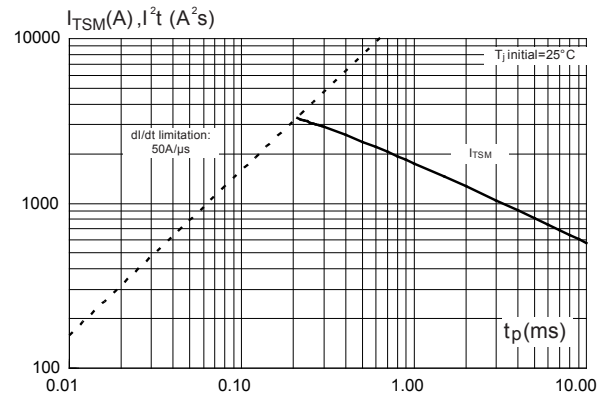
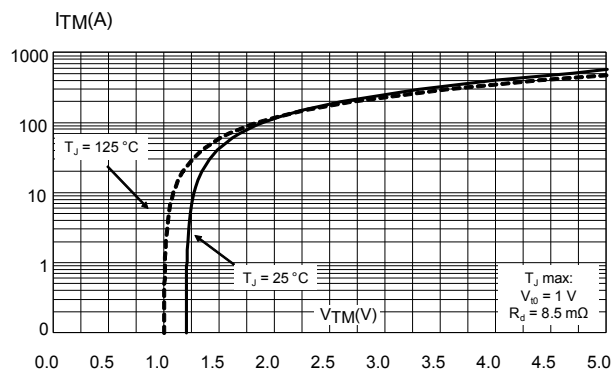

Figure 7. On-state characteristics (maximum values)



2 Package information

In order to meet environmental requirements, ST offers these devices in different grades of **ECOPACK** packages, depending on their level of environmental compliance. ECOPACK specifications, grade definitions and product status are available at: www.st.com. ECOPACK is an ST trademark.

2.1 RD91 package information

- Epoxy meets UL94, V0
- Cooling method: Conduction
- Recommended torque: 0.9 to 1.2 N·m

Figure 8. RD91 package outline

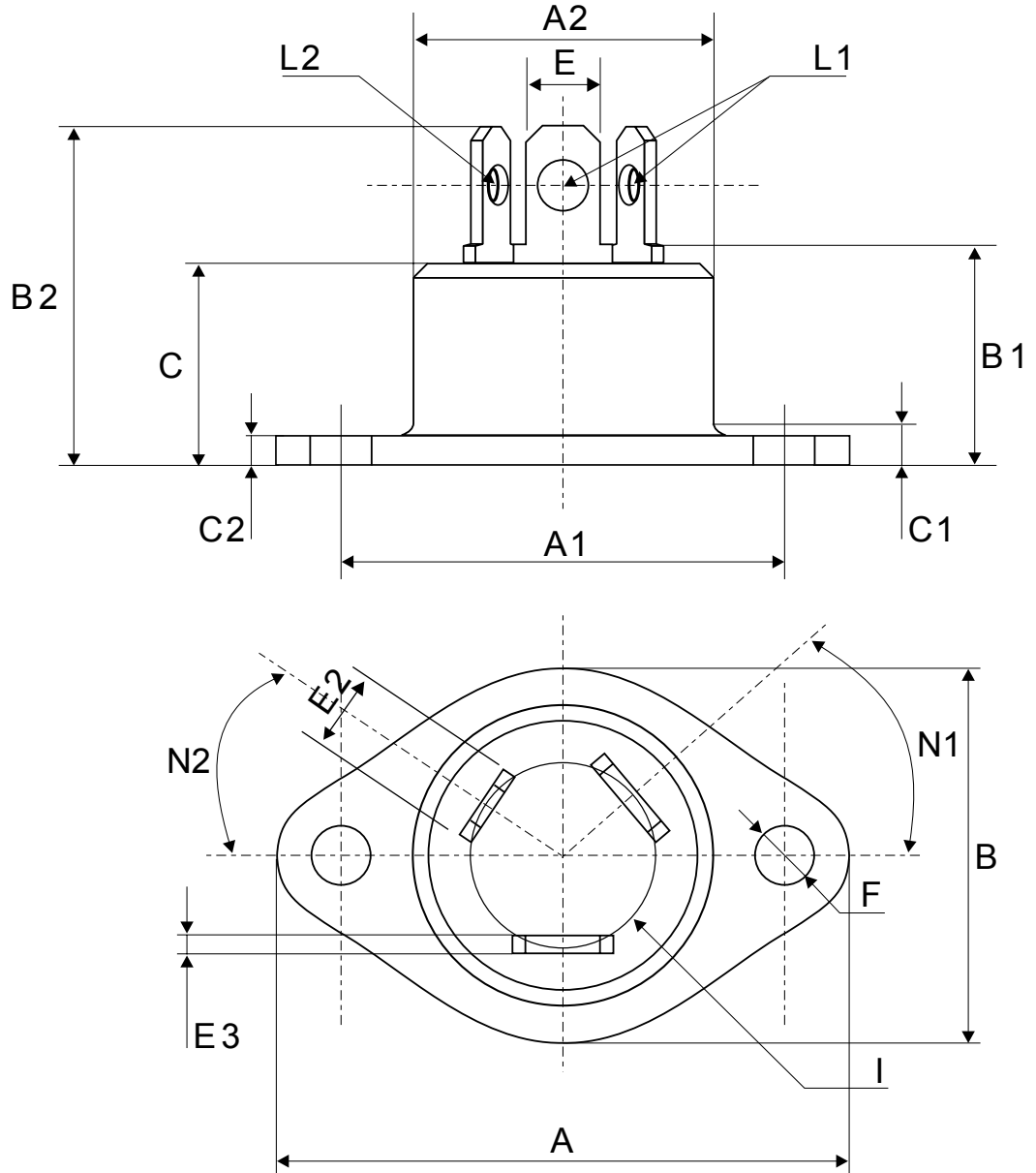

Table 4. RD91 mechanical data

Ref.	Dimensions					
	mm			Inches ⁽¹⁾		
	Min.	Typ.	Max.	Min.	Typ.	Max.
A			40.00			1.575
A1	30.10		30.30	1.185		1.193
A2			22.00			0.867
B			27.00			1.063
B1	13.50		16.50	0.531		0.650
B2			24.00			0.945
C			14.00			0.552
C1			3.50			0.138
C2	1.90		2.10	0.074		0.083
E	6.10		6.50	0.240		0.256
E2	4.80		5.20	0.188		0.205
E3	0.70		0.90	0.027		0.036
F	4.00		4.30	0.157		0.170
I	11.20		11.60	0.440		0.536
L1	3.10		3.50	0.122		0.138
L2	1.70		1.90	0.066		0.075
N1	33°		43°	33°		43°
N2	28°		38°	28°		38°

1. Inches given for reference only

3 Ordering information

Figure 9. Ordering information scheme

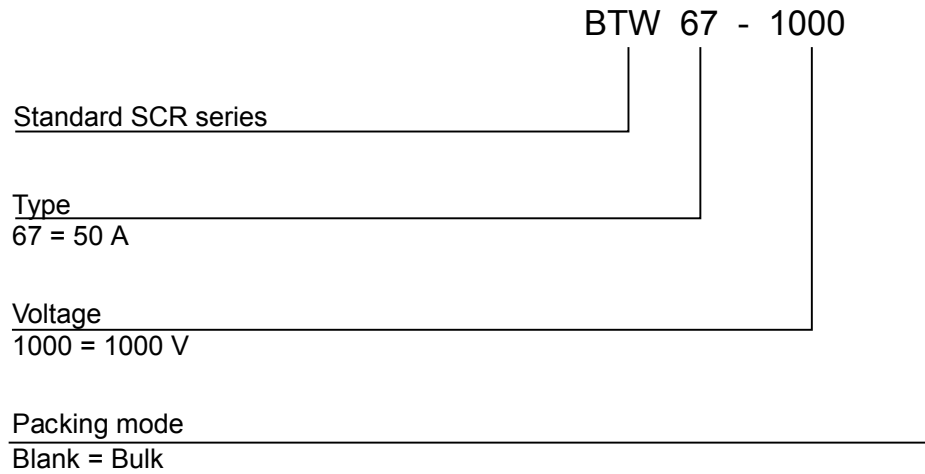

Table 5. Ordering information

Order code	Marking	Package	Weight	Base qty.	Delivery mode
BTW67-1000	BTW671000	RD91	20 g	25	Bulk

Revision history

Table 6. Document revision history

Date	Revision	Changes
Apr-2001	4A	Last update.
13-Feb-2006	5	TOP3 Insulated delivery mode changed from bulk to tube. ECOPACK statement added.
26-Jun-2019	6	Removed TOP3 Ins. package information. Minor text changed.