

## 50 A 600 V SCR in TOP3 insulated

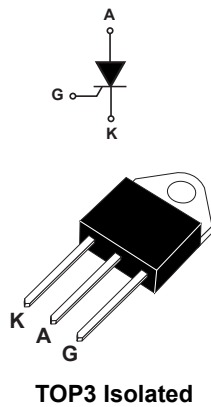

### Features

- Max. repetitive blocking voltage:  $V_{DRM}$ ,  $V_{RRM} = 600\text{ V}$
- $I_{GT}$  maximum = 80 mA
- ECOPACK<sup>®</sup>2 component (RoHS and HF compliance)
- Complies with UL 1557 standard (File ref : E81734)

### Applications

- Solid state relays
- Welding equipment
- High power motor control
- Heating systems
- Controlled AC/DC bridge

### Description

Available in a high power package TOP3-I, the **BTW69-600** is suitable in applications where power handling and power dissipation are critical, such as solid state relays, welding equipment, high power motor control and power converters.

This device offers a superior performance in surge current handling capabilities, allowing usage in industrial environment.

Thanks to its internal ceramic pad, it provide high voltage insulation ( $2500V_{RMS}$ ), complying with UL standards (file ref: E81734).

#### Product status link

[BTW69-600](#)

#### Product summary

$I_{T(RMS)}$	50 A
$V_{DRM}/V_{RRM}$	600 V
$I_{GT}$	80 mA

# 1 Characteristics

**Table 1. Absolute maximum ratings**

Symbol	Parameters		Value	Unit	
$I_{T(RMS)}$	RMS on-state current (180° conduction angle)		$T_C = 75\text{ °C}$	50	A
$I_{T(AV)}$	Average on-state current (180° conduction angle)		$T_C = 75\text{ °C}$	32	A
$I_{TSM}$	Non repetitive surge peak on-state current (full cycle, $T_j$ initial = 25 °C, $V_R = 0$ V)		$t_p = 8.3$ ms	610	A
			$t_p = 10$ ms	580	
$I^2t$	$I^2t$ value for fusing	$t_p = 10$ ms, $T_j = 25\text{ °C}$		1680	A <sup>2</sup> s
$di/dt$	Critical rate of rise of on-state current $I_G = 2 \times I_{GT}$ , $t_r \leq 100$ ns	F = 60 Hz	$T_j = 125\text{ °C}$	50	A/ $\mu$ s
$I_{GM}$	Peak gate current	$t_p = 20\ \mu$ s	$T_j = 125\text{ °C}$	8	A
$P_{G(AV)}$	Average gate power dissipation		$T_j = 125\text{ °C}$	1	W
$T_{stg}$	Storage junction temperature range			-40 to +150	°C
$T_j$	Operating junction temperature range			-40 to +125	°C
$V_{GRM}$	Maximum peak reverse gate voltage			5	V
$V_{ins}$	Insulation RMS voltage, 1 minute			2500	V

**Table 2. Electrical characteristics ( $T_j = 25\text{ °C}$ , unless otherwise specified)**

Symbol	Test conditions	$T_j$		Value	Unit
$I_{GT}$	$V_D = 12$ V, $R_L = 33\ \Omega$		Min.	8	mA
			Max	80	
$V_{GT}$			Max	1.3	V
$V_{GD}$	$V_D = V_{DRM}$ , $R_L = 3.3$ k $\Omega$	125 °C	Min.	0.2	V
$I_H$	$I_T = 500$ mA, gate open		Max.	150	mA
$I_L$	$I_G = 1.2 \times I_{GT}$		Max.	200	mA
$dV/dt$	$V_D = 67\%$ , $V_{DRM}$ gate open	125 °C	Min.	1000	V/ $\mu$ s
$V_{TM}$	$I_{TM} = 100$ A, $t_p = 380\ \mu$ s		Max.	1.9	V
$V_{TO}$	Threshold on-state voltage	125 °C	Max.	1.0	V
$R_D$	On-state dynamic resistance	125 °C	Max.	8.5	m $\Omega$
$I_{DRM}/I_{RRM}$	$V_D = V_{DRM}$ , $V_R = V_{RRM}$	25 °C	Max.	10	$\mu$ A
		125 °C		5	mA

**Table 3. Thermal resistance**

Symbol	Parameters	Value	Unit
$R_{th(j-c)}$	Junction to case (D.C)	0.9	°C/W
$R_{th(j-a)}$	Junction to ambient (D.C)	50	

## 1.1 Characteristics (curves)

**Figure 1. Maximum average power dissipation versus average on-state current**

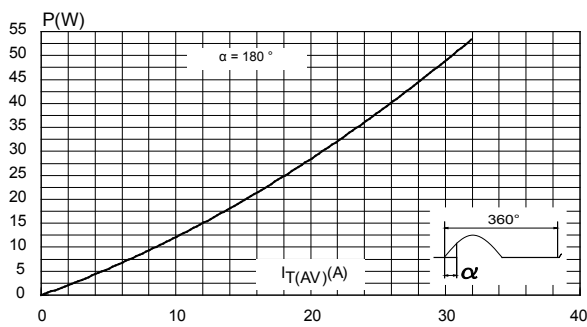

**Figure 2. Average on-state current versus case temperature**

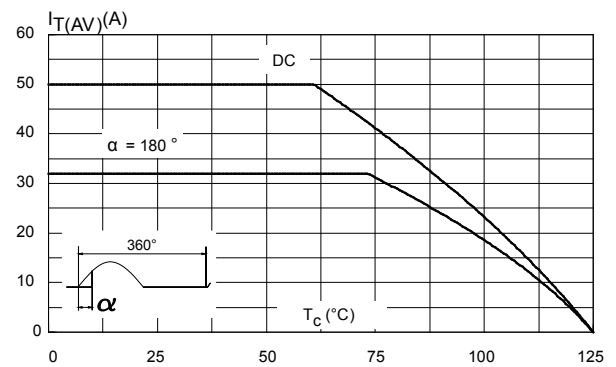

**Figure 3. Relative variation of thermal impedance versus pulse duration**

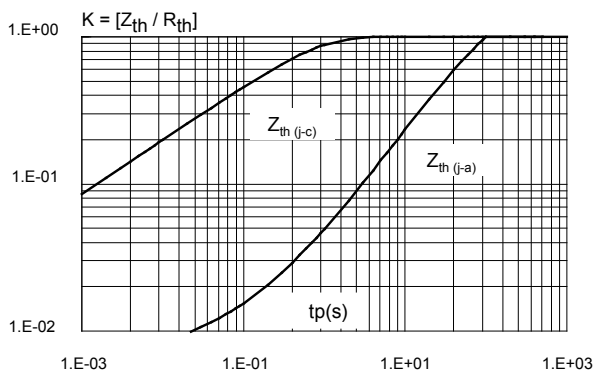

**Figure 4. Relative variation of gate trigger current, holding current and latching current versus junction temperature**

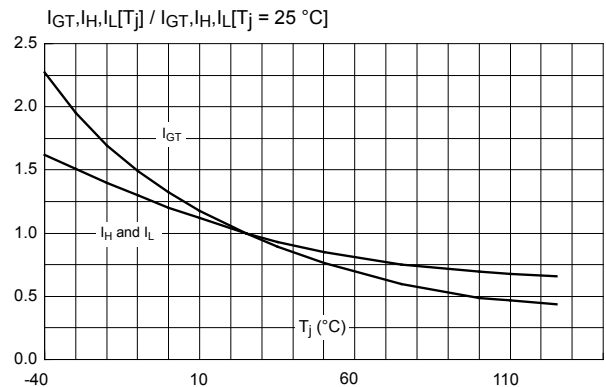

**Figure 5. Surge peak on-state current versus number of cycles ( $V_R = 0$  V)**

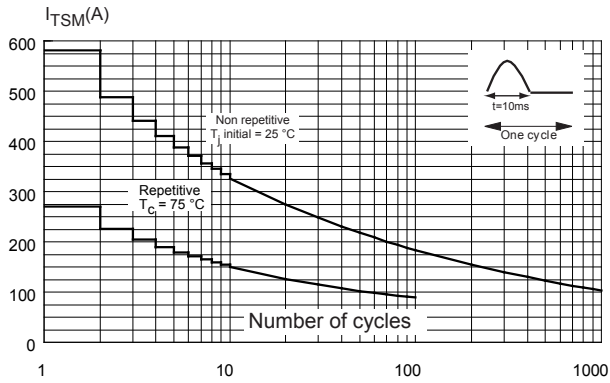

**Figure 6. Non repetitive surge peak on-state current for a sinusoidal pulse with width  $t_p < 10$  ms, and corresponding value of  $I^2t$  ( $V_R = 0$  V)**

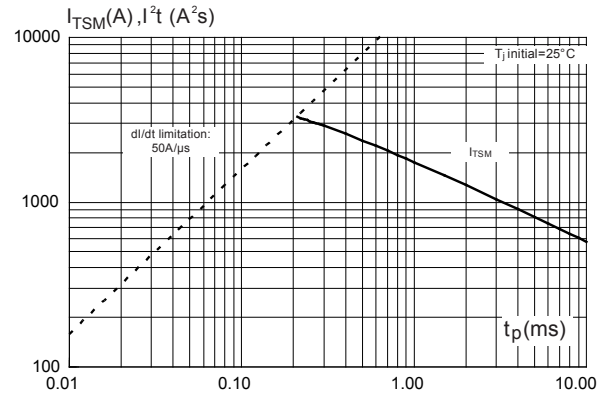

**Figure 7. On-state characteristics (maximum values)**

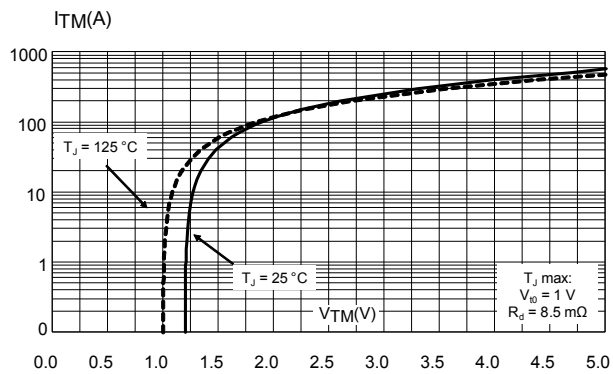

## 2 Package information

In order to meet environmental requirements, ST offers these devices in different grades of **ECOPACK** packages, depending on their level of environmental compliance. ECOPACK specifications, grade definitions and product status are available at: [www.st.com](http://www.st.com). ECOPACK is an ST trademark.

### 2.1 TOP3 Ins. package information

- **ECOPACK®** (Lead-free plating and Halogen free package compliance)
- Lead-free package leads finishing
- Halogen-free molding compound resin meets UL94 standard level V0
- Recommended torque: 1.05 N·m (max. torque: 1.2 N·m)

**Figure 8. TOP3 Isolated package outline**

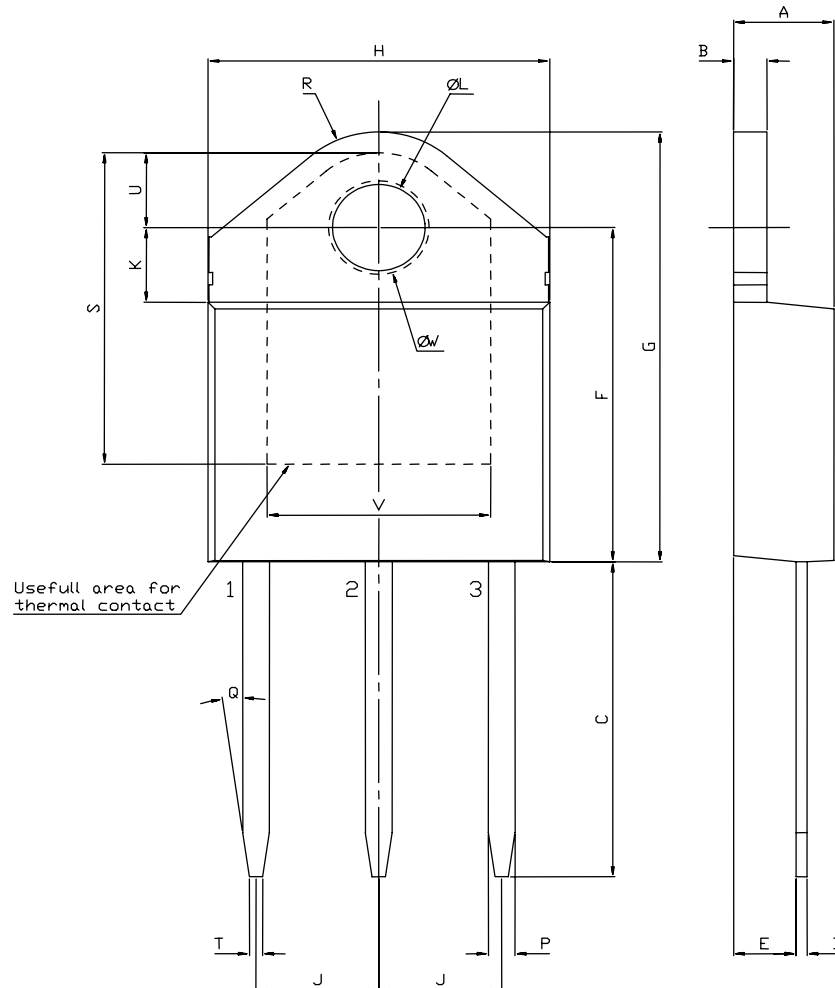

**Table 4. TOP3 Isolated mechanical data**

Ref.	Dimensions					
	mm			Inches <sup>(1)</sup>		
	Min.	Typ.	Max.	Min.	Typ.	Max.
A	4.40		4.60	0.1732		0.1811
B	1.45		1.55	0.0571		0.0610
C	14.35		15.60	0.5650		0.6142
D	0.50		0.70	0.0197		0.0276
E	2.70		2.90	0.1063		0.1142
F	15.80		16.50	0.6220		0.6496
G	20.40		21.10	0.8031		0.8307
H	15.10		15.50	0.5945		0.6102
J	5.40		5.65	0.2126		0.2224
K	3.40		3.65	0.1339		0.1437
L	4.08		4.17	0.1606		0.1642
M	1.20		1.40	0.0472		0.0551
R		4.60			0.1811	

1. Inches given for reference only

### 3 Ordering information

Figure 9. Ordering information scheme

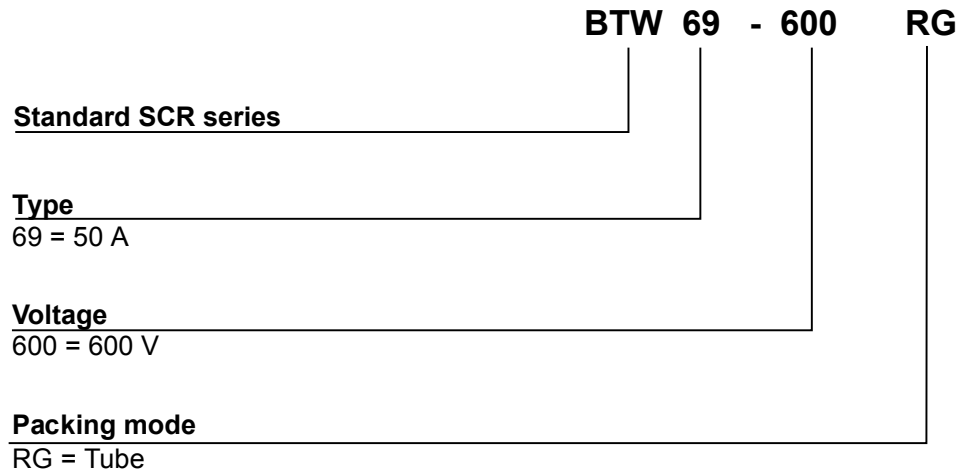

Table 5. Ordering information

Order code	Marking	Package	Weight	Base qty.	Delivery mode
BTW69-600RG	BTW69600	TOP3 Ins.	4.5 g	30	Tube

## Revision history

**Table 6. Document revision history**

Date	Revision	Changes
09-Sep-2019	1	Initial release.