

BU-1420761891 (CONN SMA JACK STR 50OHM EDGE MNT)

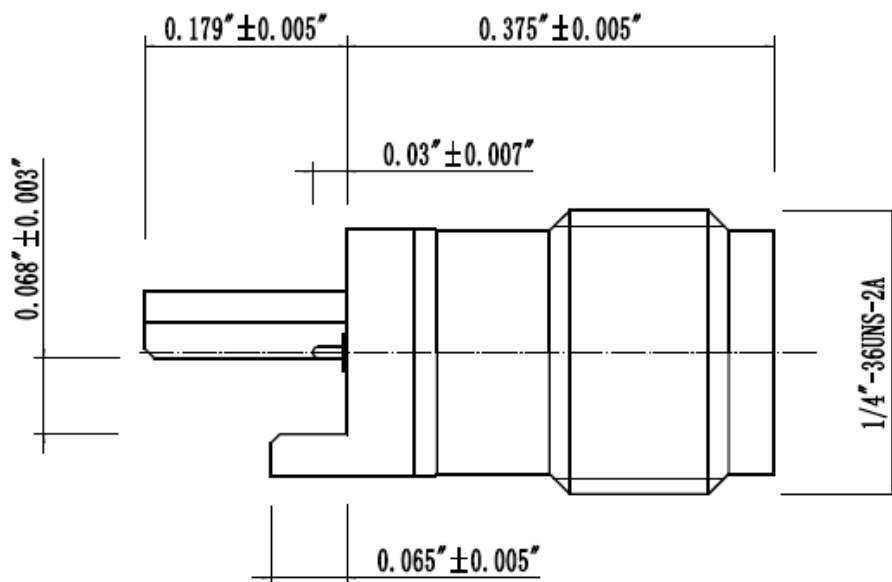

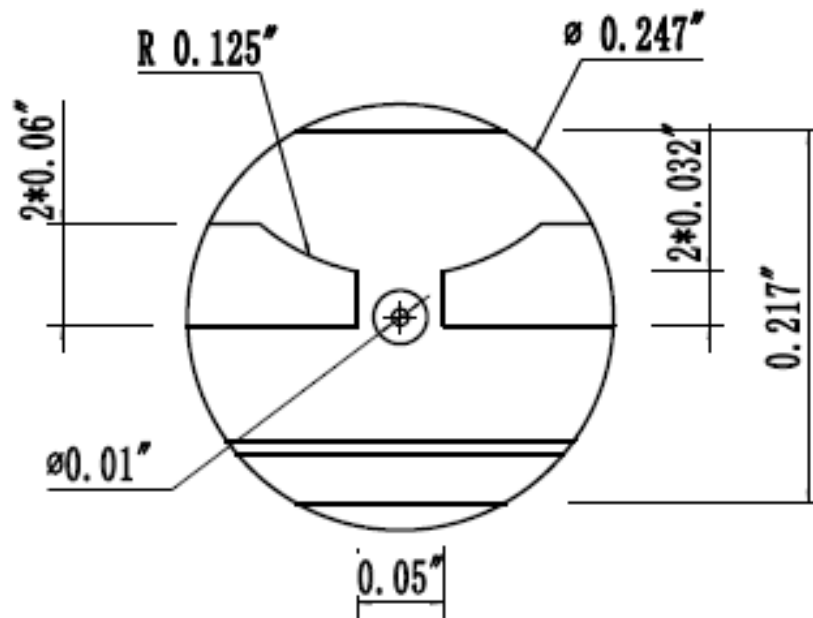

(Dimensions in Inches)

- Impedance: 50 Ohms
- Frequency Range: 0-26.5G
- VSWR: 1.4 Max at 0-18G
- Working Voltage: 170V At Sea Level
- Dielectric withstanding Voltage: 335V Min at Sea Level
- Contact Resistance at Center Contact: < 3.0 milliohms
- Material:
 - Body: "1U" Gold plated Brass
 - Contact: "5U" Gold plated Beryllium Copper
 - Insulator: Teflon
- Meets or exceeds the applicable paragraph of Mil-C-39012
- Operating Temperature: -65°C (-85°F) to 150°C (302°F)
- RoHS 3 Compliant