

## Overview

The C/CT series clamp-on current sensors can be used to measure currents in live wires.

## Applications

Typical applications include EMS current measurement, high performance distributions boards, power conditioners, power monitoring systems, inverters and industrial machinery.

## Benefits

- Compact and slim design
- Flat temperature characteristics
- UL 94 V-0 flame retardant rated case
- RoHS compliant

## Ordering Information

C/CT-	12	16
Series	Rated Current AC (A)	Diameter (mm)
C/CT	03 = 30 12 = 120 25 = 250	06 = 6 16 = 16 24 = 24

C/CT-0306



C/CT-1216



C/CT-2524



## Dimensions in mm

**C/CT-0306**

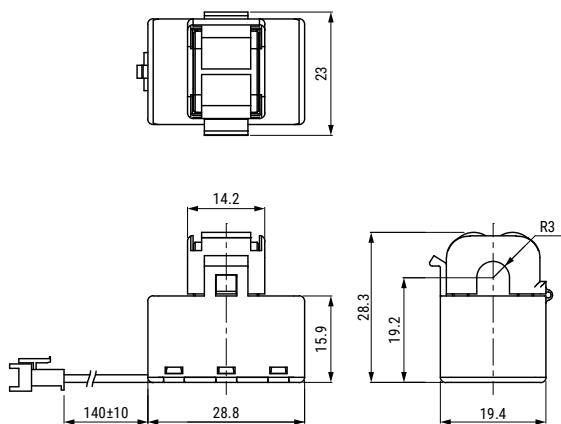

**Primary Current Direction**

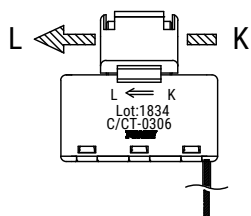

**Secondary Current Direction**

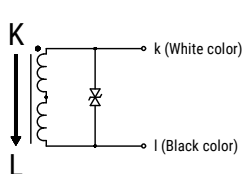

**C/CT-1216**

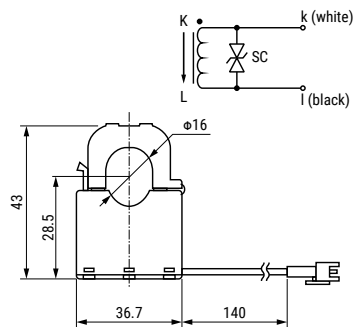

Connector SMR-02V-B (J.S.T)  
(Mating Connector: SMP-02V-B)

**C/CT-2524**

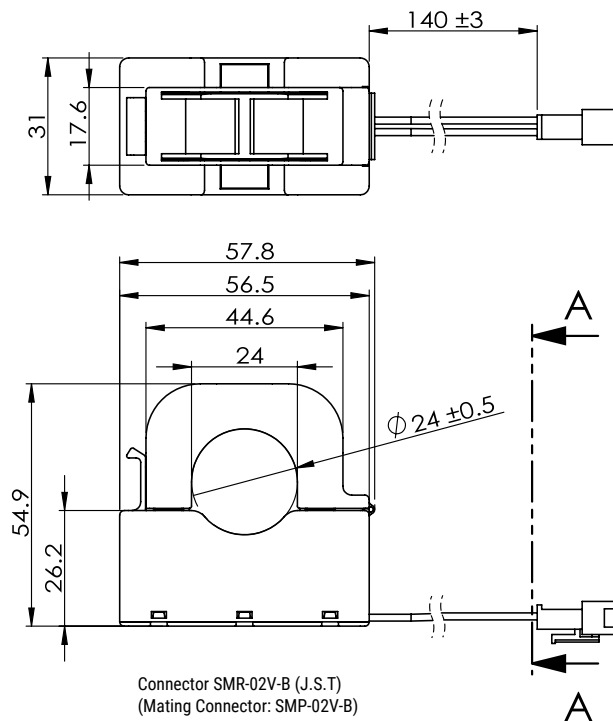

Connector SMR-02V-B (J.S.T)  
(Mating Connector: SMP-02V-B)

## AC Output Voltage Characteristics

C/CT-0306

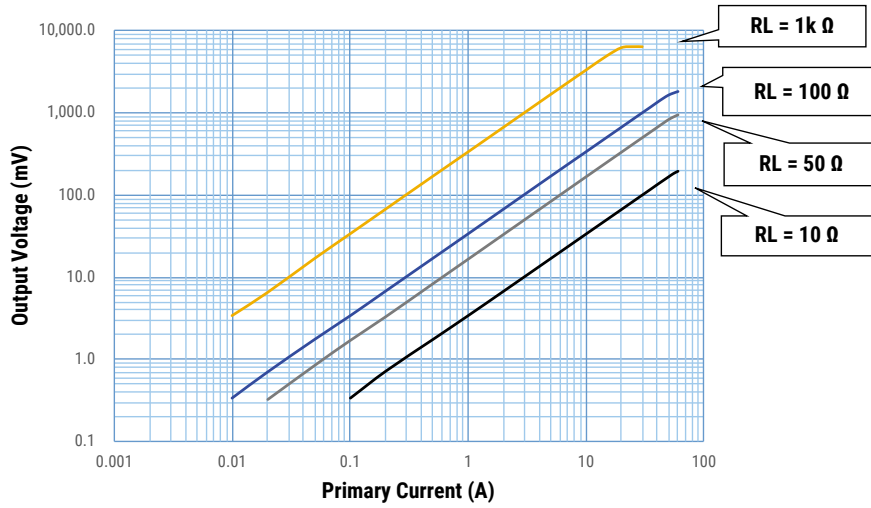

C/CT-1216

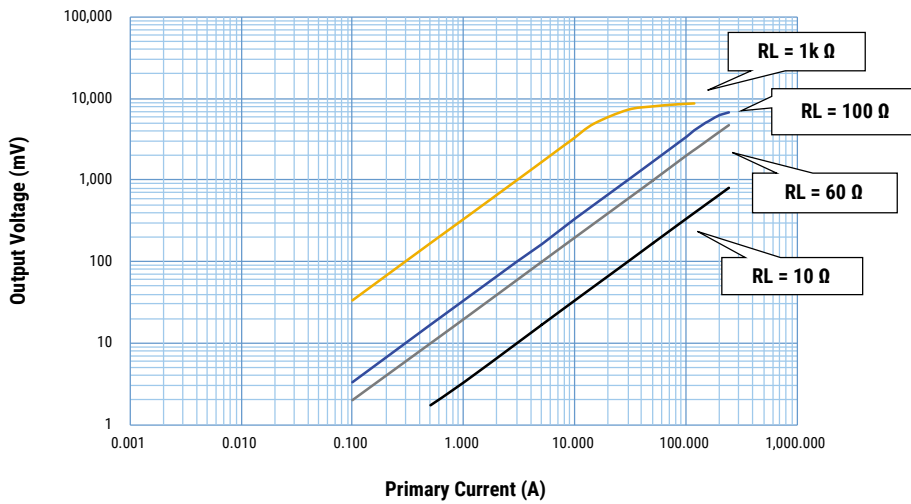

## AC Output Voltage Characteristics cont.

C/CT-2524

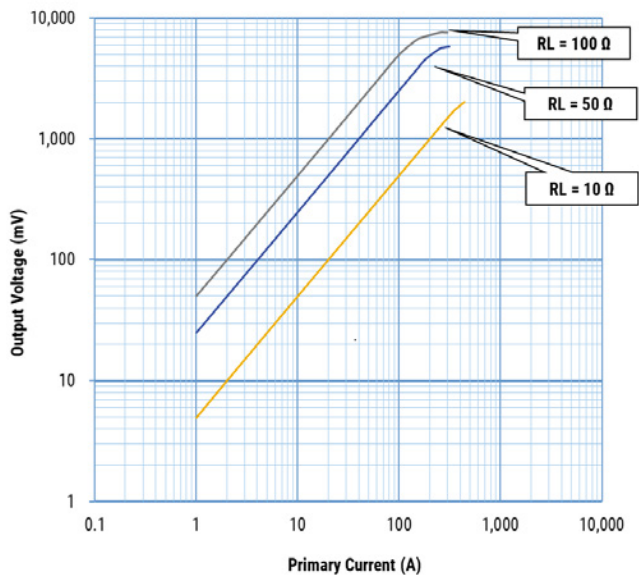

## Environmental Compliance

All C/CT sensors are RoHS compliant.



## Specifications

Item	Performance Characteristics
Rated Current	30 - 250 A
Applicable Current	0.1 – 340 A
Output Voltage	100 ±2 mV for C/CT-0306 400 ±8 mV for C/CT-1216 1,250 ±25 mV for C/CT-2524
Current Transformation Ratio	3,000 for C/CT-0306 and C/CT-1216 2,000 for C/CT-2524
Output Protection	7.5 V
Insulation Resistance	100 MΩ at 500 VDC (between core and terminal)
Operating Temperature Range	-10°C to +60°C
Storage Temperature Range	-20°C to +75°C

### Table 1 – Ratings & Part Number Reference

Part Number	Rated Current <sup>1</sup> (A)	Applicable Current <sup>1</sup> (A)	Output Voltage <sup>2</sup> (mV)	Current Transformation Ratio	Output Protection (V)	Insulation Resistance <sup>3</sup>	Weight (g)
C/CT-0306	30	0.1 – 50.0	100 ±2	3,000	7.5	100 MΩ	23.7
C/CT-1216	120	0.1 – 150.0	400 ±8	3,000	7.5	100 MΩ	63.3
C/CT-2524	250	0.1 – 340.0	1,250 ±25	2,000	7.5	100 MΩ	137.0

<sup>1</sup> 50 Hz/60 Hz

<sup>2</sup> Measurement conditions from output voltage:  $f = 50 \text{ Hz}$ ,  $R_L = 10 \Omega$ ,  $I_o = 30 \text{ A}$  for C/CT-0306 & 120 A for C/CT-1216 & 250 A for C/CT-2524

<sup>3</sup> At 500 VDC, between core and terminal

## Packaging

Part Number	Packaging Type	Pieces Per Box
C/CT-0306	Tray	144
C/CT-1216		108
C/CT-2524		48

## Handling Precautions

### Precautions for Product Storage

Current sensors should be stored in normal working environments. While the sensors are quite robust in other environments, exposure to high temperatures, high humidity, corrosive atmospheres, and long-term storage degrade solderability.

KEMET recommends that maximum storage temperature not exceed 75°C, and that atmospheres should be free of chlorine and sulfur-bearing compounds. Temperature fluctuations should be minimized to avoid condensation on the parts. Avoid storage near strong magnetic fields, as they can magnetize the product and cause its characteristics to change.

The stock of current sensors should be used within 24 months of receipt.

### Before Using High Alternating Current Sensors, Snap-on Type

- Do NOT drop or apply any other mechanical stress, as such stresses may change performance characteristics.
- Conduct a preliminary study when heating by current conduction (required).
- Do NOT use the high alternating current sensors, snap-on type, opened between secondary output terminals. Heat build-up in the magnetic core may occur, resulting in damage to the parts by coil melting.
- Install at room temperature. Open/close operation at below 5°C may break hinge of the case.