

c-enx™
EN 4644 Electrical & Fiber Interconnect Solutions Catalog



cinch
CONNECTIVITY SOLUTIONS
a bel group

belfuse.com/cinch

About Cinch Connectivity Solutions

For 100 years, Cinch Connectivity Solutions has manufactured high quality & reliable high performance connectors & cable assemblies to the Aerospace, Military/Defense, Commercial, Rugged Harsh Environments & Communication markets. Our custom solutions deliver creative, hands-on engineering whilst utilizing multiple contact technologies including fiber optic expanded beam and QPL listed products. We aim to exceed our customers' expectations & continually provide innovative solutions to the rapidly changing needs of the markets & customers we serve.

Table of Contents

Introduction

| | |
|----------------------------|---|
| Disconnect Application | 4 |
| Rack and Panel Application | 5 |

c-enx™ Series

| | |
|---|---|
| Technical Characteristics for Disconnect Connectors | 6 |
| Technical Characteristics for Rack & Panel Connectors | 7 |
| Technical Characteristics: Inserts & Contacts | 8 |
| Mechanical Characteristics: Inserts & Contacts | 9 |

Inserts

| | |
|-----------------------------|----|
| Insert Selection Table | 10 |
| How to Order C-ENX Inserts | 11 |
| C-ENX A Insert Arrangements | 12 |
| C-ENX B Insert Arrangements | 12 |
| C-ENX B Insert Arrangements | 13 |

Contacts

| | |
|--|----|
| Power & Signal Crimp Contacts | 14 |
| Oversized & Reduced Crimp Barrel Contacts | 15 |
| Coaxial Crimp Contacts | 16 |
| Twinax & Triax Crimp Contacts | 17 |
| Quadrax & BMA Crimp Contacts | 18 |
| Signal PC Tail Contacts | 20 |
| Filler/Sealing Plugs & QuadraxPC Tail Contacts | 21 |
| Contacts for GBE Links | 22 |

Disconnect Application

| | |
|--|----|
| c-enx™ A & c-enx™ B1 Product Overview | 23 |
| How to Order C-ENX A & C-ENX B1 Shell | 24 |
| How to Order C-ENX A & C-ENX B1 Assembly Kit | 25 |
| Contacts Termination for C-ENX B1 | 26 |
| C-ENX A Shell Dimensions | 27 |
| C-ENX B1 Shell Dimensions | 28 |
| Polarization Code | 29 |

| | |
|--------------------------------------|----|
| C-ENX A & C-ENX B1 Accessories | 30 |
| C-ENX B2 Disconnect Connectors | 31 |
| c-enx™ B2 Product Overview | 32 |
| How to Order C-ENX B2 Shell | 33 |
| How to Order C-ENX B2 Assembly Kit | 34 |
| Contacts Termination for Receptacles | 35 |
| C-ENX B2 Metallic Shell Dimensions | 36 |
| C-ENX B2 Composite Shell Dimensions | 37 |
| C-ENX B2 Polarization Code | 38 |
| C-ENX B2 Polarization Code | 39 |
| C-ENX B2 Accessories | 40 |
| C-ENX B2 Spare Parts | 41 |
| Tools | 42 |

Rack & Panel Application

| | |
|---|----|
| c-enx™ B1 Product Overview | 43 |
| c-enx™ B2 Product Overview | 43 |
| c-enx™ B3 Product Overview | |
| How to Order C-ENX B1, B2, B3 & B4 Shell | 44 |
| c-enx™ B4 Product Overview | 45 |
| How to Order C-ENX B1, B2, B3 & B4 Assembly Kits | 46 |
| Contacts Termination for C-ENX B1, B2, B3, B4 Plugs | 47 |
| C-ENX B1 Shell Dimensions & Panel Cut-Outs | 48 |
| C-ENX B2 Shell Dimensions & Panel Cut-Outs | 49 |
| C-ENX B3 Shell Dimensions & Panel Cut-Outs | 50 |
| C-ENX B4 Shell Dimensions & Panel Cut-Outs | 51 |
| C-ENX B Panel Cut-Out Coding | 52 |
| C-ENX B Polarization Code | 53 |
| Rack & Panel Accessories | 54 |
| Rack & Panel tools | 55 |
| c-enx™ Galley Product Overview | 56 |
| How to Order C-ENX Galley Equipment Connector | 57 |
| Dimensions and Panel Cut Out | 58 |
| Multi-Gang C-ENX Connectors | 59 |

YOU NEED A SPACE, WEIGHT & COST SAVING SOLUTION. WE HAVE ONE.

Cinch is an established provider of interconnect products. We understand and solve engineering challenges in Commercial Aerospace and Military applications.

Our c-enx™ series EN 4644 modular connectors are ideal for applications with limited space and weight restrictions. Cinch manufactures harnesses equipped with c-enx™ for Avionics, Radar, Power and Flight management applications.

Save Time and Money with our Simple Installation

- Easy to install with our common panel cut-out
- Wire your insert in the workshop, install in the shells later
- Simple insert installation and removal from shells
- No more mis-mating with our keyed shells and inserts
- Crimp contacts which are inserted and extracted with standard mil spec tools
- Sub-assemblies are field replaceable
- Self-locking threads are vibration resistant



Modular solution

- Shell accommodate inserts for signal, power, coax, data bus, fiber optic and high frequency BMA contacts
- Ground block option for FAA HIRF requirements
- Plug and receptacle shells accommodate pin and socket inserts installation (pin contacts are fitted in the pin insert)

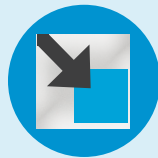

Two insert sizes, Two Materials

Shell materials include aluminum and composite material providing solutions for many applications.

Space Saving

Slim, high density, stackable design. No need for extra room to lock and unlock connectors.

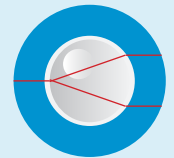

EBOSA Available

Our c-enx™ Series is available with electrical and optical interfaces including, Cinch EBOSA™ Expanded Beam Technology. Our patented active alignment technology which aligns a standard LC ferrule to Cinch's EBOSA™ with ultra-high precision.

How C-ENX™ stacks up against circular connectors

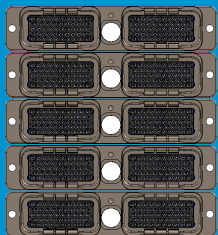

C-ENX B:

5 shells #2 with 2*48 Cts
 » Total Cts: 480
 » Total surface:
 $96.90 * 91.80 = 8895.42 \text{ mm}^2$
 Gives $18.53 \text{ mm}^2/\text{contact}$

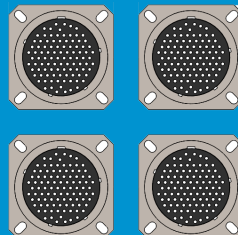

38999 :

4 shells #23 with 100 Cts
 » Total Cts: 400
 » Total surface: $96.00 * 96.00 = 9216 \text{ mm}^2$
 Gives $23.04 \text{ mm}^2/\text{contact}$

DISCONNECT APPLICATION

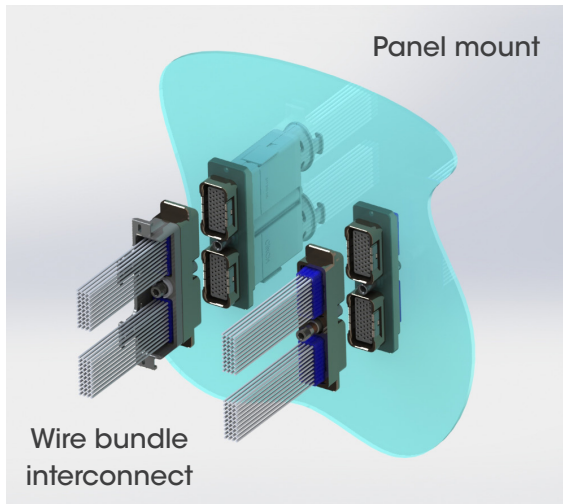

The Cinch c-enx™ connector series is designed for use in a PCB-cable disconnect and in cable-cable disconnect applications.

Each connector in our C-ENX A, C-ENX B1 and C-ENX B2 line has a locking system on the connector itself.

Compact, Modular, and Easy to Use.

- Compact: Access our locking system design from the back of the shell. Space is saved and connectors can be stacked.
- Modular: Use the same tools and accessories; spare parts are reduced.
- Easy assembly: Mate the connector on panel with a standard Allen wrench tool.

Configurable components create high performance connectors (environmental, grounding blocks, shell mountings, etc). Harnesses can be developed utilizing several types of accessories including backshells.

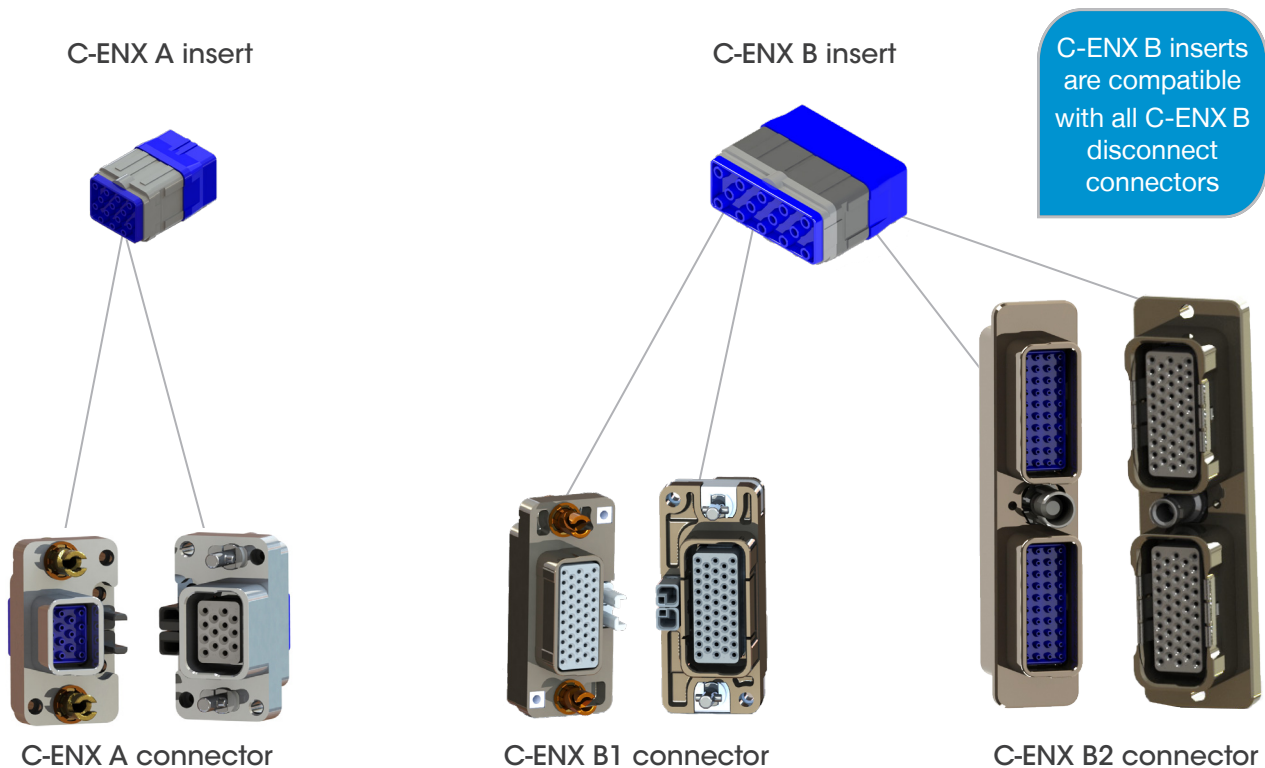

RACK AND PANEL APPLICATION

Cinch offers rack and panel connectors accommodating new equipment design and miniaturization requirements for Line Replaceable Module (LRM) applications.

These connectors are designed for blind mate applications. The receptacle is installed on the aircraft rack while the plug connector is used in an LRM. Locking mechanisms are part of aircraft equipment interface; not the blind mate connectors.

c-enx™: Wide range, Reliable, ARINC 600 functionality

- Offered in sizes 1 to 4 in a wide range of connectors based on the same design.
- Series uses same standard accessories, polarization and mounting style.
- Our system prevents mismatching between panel and receptacle shell, as well as between the plug receptacle shells. Electronic system mounting mistake proofing with Cinch's polarization device.
- Save space: our modular mounting c-enx® connectors are offered in several styles (fixed or float mount).
- Rack and panel receptacles feature ARINC 600 functionality.

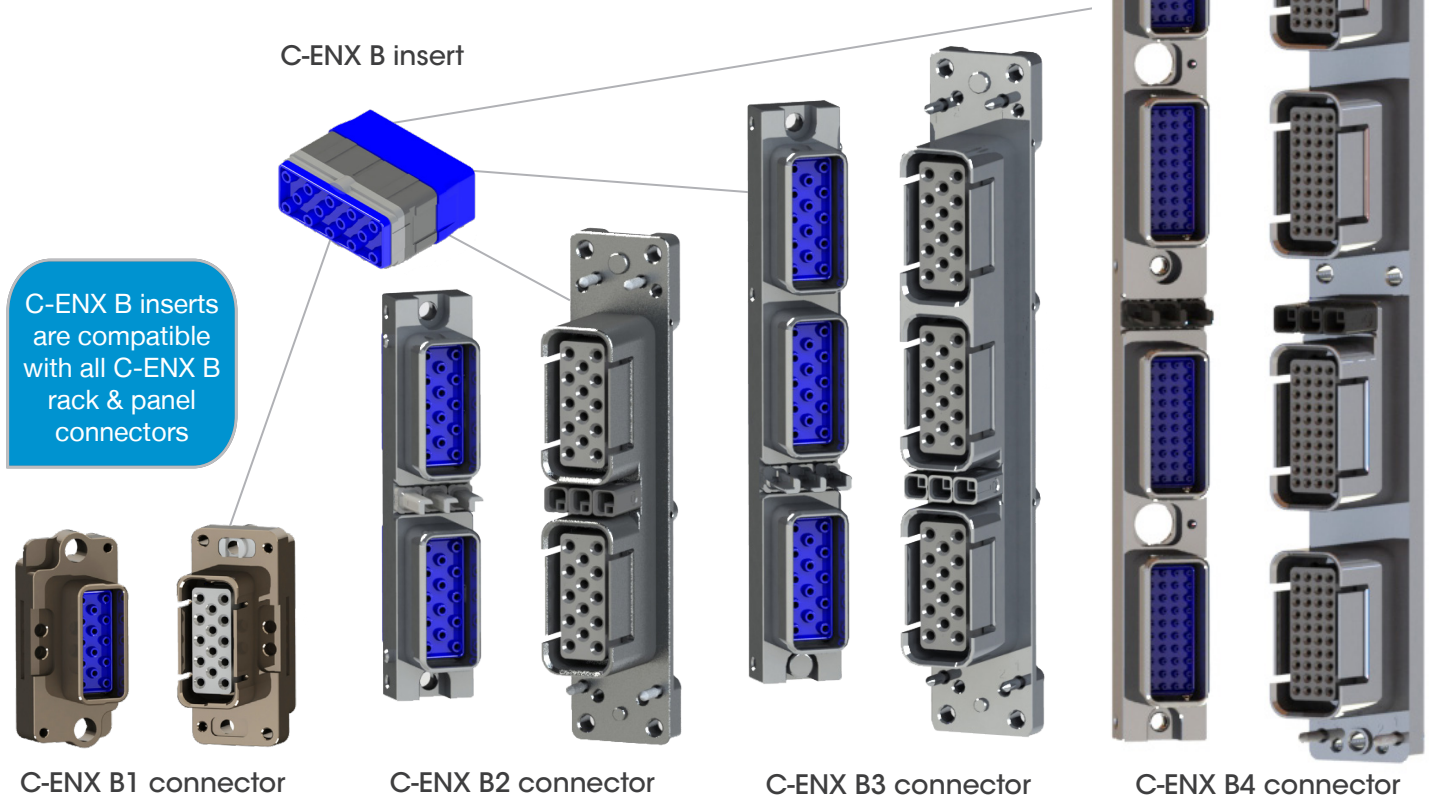
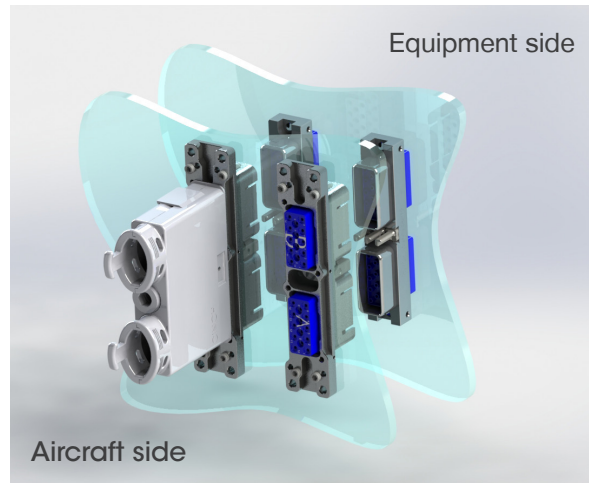

TECHNICAL CHARACTERISTICS FOR DISCONNECT CONNECTORS

Electrical Characteristics

EMI Shielding Effectiveness per EN 2591-213

| Frequency (MHz) | Leakage Attenuation (dB) |
|-----------------|--------------------------|
| 100 | 65 |
| 200 & 300 | 63 |
| 400 | 62 |
| 500 & 600 | 60 |

Other Characteristics

- **Shell to shell conductivity** < 2.5 mΩ, operating voltage: 400 Vrms or 500 Vdc at sea level, according to EN 2591-205
- **Voltage stability (ground block):** Maximum variation 4mV according to SAE AS 81714 (MIL-T-81714)
- **Lightning strike:**
 - 5kA - 1600V for C-ENX connectors in aluminum version
 - 3kA - 1600V for C-ENX connectors in composite version

Mechanical Characteristics

Mating/unmating

| Shell type | Material | Mating/Unmating |
|------------|-----------|---------------------------|
| C-ENX A | Aluminum | 100 cycles |
| C-ENX B1 | Aluminum | 100 cycles |
| C-ENX B1 | Composite | 100 cycles |
| C-ENX B2 | Composite | 100 cycles ⁽¹⁾ |
| C-ENX B2 | Aluminum | 100 cycles ⁽¹⁾ |

Shock & Vibration

| Shell Type | Material | Vibration | Shock |
|--|-----------|---|--|
| | | For 8 hrs on each of the 3 axis/ interruption <1μs EN 2591-403 EIA 364-28 | 3 shocks on each axis EN 2591-402 EIA 364-27 |
| C-ENX A | Aluminum | Acceleration 27.8g (test condition 6 letter G) | Shock amplitude 50g /duration 11ms |
| C-ENX B1 | Aluminum | Acceleration 27.8g (test condition 6 letter G) | Shock amplitude 50g /duration 11ms |
| C-ENX B1 | Composite | Acceleration 27.8g (test condition 6 letter G) | Shock amplitude 50g /duration 11ms |
| C-ENX B2 | Composite | Acceleration 27.8g (test condition 6 letter G) | Shock amplitude 50g /duration 11ms |
| C-ENX B2 | Aluminum | Shock amplitude 300g /duration 3ms | Shock amplitude 300g /duration 3ms |
| Disconnect C-ENX with Quadrax contacts | / | Acceleration 16.9g (test condition 5 letter E) | Shock amplitude 50g /duration 11ms |

NOTE:

(1) 500 mating cycles possible when using lubricant (as per the standard Mil-spec DOD G 24508) on locking device

TECHNICAL CHARACTERISTICS FOR RACK & PANEL CONNECTORS

Electrical Characteristics

EMI Shielding Effectiveness per EN 2591-213

| Frequency (MHz) | Leakage Attenuation (dB) |
|-----------------|--------------------------|
| 100 | 65 |
| 200 & 300 | 63 |
| 400 | 62 |
| 500 & 600 | 60 |

Other Characteristics

- **Shell to shell conductivity** < 2.5 m Ω, operating voltage: 400 Vrms or 500 Vdc at sea level, according to EN 2591-205
- **Voltage stability (ground block):** Maximum variation 4mV according to SAE AS 81714 (MIL-T-81714)
- **Lightning strike:**
 - 5kA - 1600V for C-ENX connectors in Aluminum version
 - 3kA - 1600V for C-ENX connectors in composite version

Mechanical Characteristics

Mating/unmating

| Shell Type | Material | Mating/Unmating |
|------------|----------|-----------------|
| C-ENX B1 | Aluminum | 500 cycles |
| C-ENX B2 | Aluminum | 500 cycles |
| C-ENX B3 | Aluminum | 500 cycles |
| C-ENX B4 | Aluminum | 500 cycles |

The minimum mating forces are described in the EN 4644 standard and depends on the connector size and insert arrangement. Consult Cinch for more information.

Shock & Vibration

| Shell Type | Material | Vibration | Shock |
|------------|----------|--|--|
| | | For 8 hrs on each of the 3 axis / interruption <1μs EN 2591-403 EIA 364-28 | 3 shocks on each axis EN 2591-402 EIA 364-27 |
| C-ENX B1 | Aluminum | Acceleration 16.9g (test condition 5 letter E) | Shock amplitude 50g /duration 11ms |
| C-ENX B2 | Aluminum | Acceleration 16.9g (test condition 5 letter E) | Shock amplitude 50g /duration 11ms |
| C-ENX B3 | Aluminum | Acceleration 16.9g (test condition 5 letter E) | Shock amplitude 50g /duration 11ms |
| C-ENX B4 | Aluminum | Acceleration 16.9g (test condition 5 letter E) | Shock amplitude 50g /duration 11ms |

TECHNICAL CHARACTERISTICS: INSERTS & CONTACTS

Electrical Characteristics

Electrical characteristics conform to SAE AS 39029 (MIL-C-39029 type A)

Contacts conform to EN3155-076 and EN3155-077

Contacts

| Contact Size | Wire Size | Max Current Amps |
|--------------|-----------|-------------------|
| 22 | AWG 22 | 5 |
| | AWG 24 | 3 |
| | AWG 26 | 2 |
| 20 | AWG 20 | 7.5 |
| | AWG 22 | 5 |
| | AWG 24 | 3 |
| 16 | AWG 16 | 13 |
| | AWG 18 | 10 |
| | AWG 20 | 7.5 |
| 12 | AWG 12 | 23 |
| | AWG 14 | 17 |
| | AWG 16 | 13 |
| 8 | AWG 8 | 46 |
| | AWG 10 | 33 |
| 5 | AWG 8 | 80 ⁽¹⁾ |
| | AWG 10 | 33 |

NOTE:

(1) Size 5 contacts are not part of SAE AS 39029 (MIL-C-39029 type A). They are qualified by Cinch to 80 Amps.

Ground Block Contact

| | Contact with Wire Size | Max Current Amps |
|-----------------------------|------------------------|------------------|
| Contact to contact | Contact + AWG 20 | 7.5 |
| Contact to mounting surface | Contact + AWG 20 | 7.5 |

Dielectric Withstanding Voltage per EN 2591-207/EIA 364-20 with leakage current < 1mA

| Level | Environmental Inserts Voltage (VRMS) | Non-environmental Voltage (VRMS) |
|-------------|--------------------------------------|----------------------------------|
| Sea level | 1500 | 1500 |
| 50,000 feet | 800 | 600 |
| 70,000 feet | 800 | 300 |

Insulation Resistance per EN 2591-206/EIA 364-21

| Temperature | Insulation Resistance |
|---------------------|-----------------------|
| Ambient temperature | > 5000 MΩ |
| 175°C (+347°F) | > 200 MΩ |

MECHANICAL CHARACTERISTICS: INSERTS & CONTACTS

Retention Characteristics

Contact retention force tested per EN 2591-409 and EIA 364-29 for terminated connectors.

| Contact Size | Retention Force | Max Displacement |
|--------------|------------------|------------------|
| Ground block | 89 N (20.0 lbs) | 0.30mm (.012 in) |
| 22 | 53 N (11.9 lbs) | 0.38mm (.015 in) |
| 20 | 89 N (20.0 lbs) | 0.38mm (.015 in) |
| 16 | 111 N (25.0 lbs) | 0.38mm (.015 in) |
| 12 | 133 N (29.9 lbs) | 0.38mm (.015 in) |
| 8 | 156 N (35.1 lbs) | 0.38mm (.015 in) |
| 5 | 133 N (29.9 lbs) | 0.38mm (.015 in) |

- **Insert retention:** 400N (90 lbs) EN 2591-410 / EIA 364-35
- **Maximum insert displacement in the shell cavity:** 0.30mm (.012 in)

Environmental Characteristics

Temperature

- **Temperature range:** -65°C/+175°C (-85°F/+347°F) according to EN 2591-305 and EIA 364-32
- **Temperature range:** -65°C/+125°C (-85°F/+257°F) for C-ENX B2 composite shell and for Rack & Panel C-ENX B
- **Temperature life:** 1000 hours at maximum temperature

Other Characteristics

- **Salt spray:** 96 hours (nickel-plated Aluminum and composite) EN 2591-307 and EIA 364-26 test condition A
- **Humidity:** 10 days with temperature variation from -10°C to +65°C EIA 364-31 Method 4, test condition B
- **Altitude immersion:** 3 cycles at 50,000 feet EN 2591-314 and EIA 364-03

INSERT SELECTION TABLE

Indicate insert name when ordering C-ENX insert. Indicate insert code when ordering kit assembly.

| Series | Insert Name | Insert Code | Contact Size & Type ⁽¹⁾ | | | | | | | | | | Total Contacts | |
|---------|-------------|-------------|------------------------------------|-------|---------------|-----------------------------|---------------|-------|-------------------|-----|---------------|-------|----------------|----|
| | | | 22* | 20* | 15 or 16* | 16 | 12* | 8 | 8 | 8 | 5 | 5 | | |
| | | | Signal | Power | Power or Coax | Power in Fiber Optic Cavity | Power or Coax | Power | Quadrax or Twinax | BMA | Coax or Triax | Power | | |
| C-ENX A | 00 | 0 | | | | | | | | | | | | 0 |
| | 1C1 | A | | | | | | | | | | 1 | | 1 |
| | 1P1 | B | | | | | | | | | | | 1 | 1 |
| | 04 | C | | | 2 | | 2 | | | | | | | 4 |
| | 09 | D | | 3 | 6 | | | | | | | | | 9 |
| | 14 | E | | 14 | | | | | | | | | | 14 |
| | 14M | F | 8 | 3 | 3 | | | | | | | | | 14 |
| | 17 | G | 12 | 5 | | | | | | | | | | 17 |
| | 20 | H | 20 | | | | | | | | | | | 20 |
| C-ENX B | 00 | 0 | | | | | | | | | | | | 0 |
| | C3 | A | | | | | | | | | | 3 | | 3 |
| | P3 | B | | | | | | | | | | | 3 | 3 |
| | 3Q3 | C | | | | | | | | 3 | | | | 3 |
| | 06 | D | | | | | 6 | | | | | | | 6 |
| | 10Q2 | E | | 8 | | | | | | 2 | | | | 10 |
| | 12F6 | F | | | | 6 | | | | | | | | 12 |
| | F12C | G | | | | | | | | | | | | 12 |
| | 13C1 | H | | 6 | 4 | | 2 | | | | | 1 | | 13 |
| | 13P1 | J | | 6 | 4 | | 2 | | | | | | 1 | 13 |
| | 14 | K | | | 14 | | | | | | | | | 14 |
| | 17 | L | | 14 | | | 3 | | | | | | | 17 |
| | 20C1 | M | | 19 | | | | | | | | 1 | | 20 |
| | 20P1 | N | | 19 | | | | | | | | | 1 | 20 |
| | 22 | P | | 16 | 6 | | | | | | | | | 22 |
| | 22V | Q | | 16 | 6 | | | | | | | | | 22 |
| | 25P1 | R | 24 | | | | | | 1 | | | | | 25 |
| | 25Q1 | S | 24 | | | | | | | 1 | | | | 25 |
| | 28 | T | 22 | | 6 | | | | | | | | | 28 |
| | 30 | U | | 30 | | | | | | | | | | 30 |
| 34 | W | 18 | 16 | | | | | | | | | | 34 | |
| 40 | X | 40 | | | | | | | | | | | 40 | |
| 48 | Y | 48 | | | | | | | | | | | 48 | |
| 3T3 | Z | | | | | | | | | 3 | | | 3 | |

NOTE:

(1) Only contacts marked with an asterisk (*) are included with C-ENX inserts
 All other contacts must be ordered separately (coax, twinax, quadrax and fiber optic contacts)

HOW TO ORDER c-enx™ INSERTS

Environmental Insert

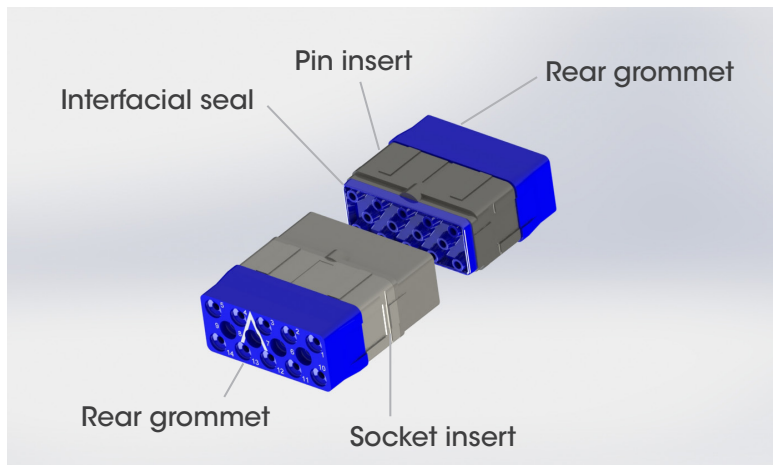

Insert Keying Detail

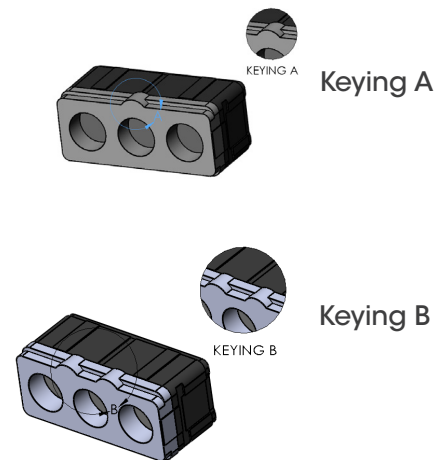

Crimp contacts only can be delivered with insert.

| | | | | | | | |
|--|--|---|---|----|---|---|---|
| Series Prefix | C-ENX | B | E | 40 | P | B | S |
| Cinch C-ENX™ Connector ⁽¹⁾ | | | | | | | |
| Insert size | A: Insert for C-ENX A B: Insert for C-ENX B1, C-ENX B2, C-ENX B3 or C-ENX B4 | | | | | | |
| Class⁽²⁾ | E: Environmental N: Non-environmental (no rear grommet, no interfacial seal) H: Non-environmental with a rear grommet, available for pin insert only (recommended for crimp contacts) T: Non-environmental with an interfacial seal, available for pin insert only (recommended for PC tail contacts) | | | | | | |
| Insert name | Refer to table on page 10 for insert arrangements | | | | | | |
| Insert type | P: Pin S: Socket | | | | | | |
| Insert keying⁽³⁾ | A: Keying A B: Keying B | | | | | | |
| Contact | Without code: insert delivered without contacts S: Signal and power contacts are delivered with inserts but are uninstalled (refer to page 10). Inserts 00, 1C1, 1P1, C3, P3, 3Q3, 12F6, F12C and 3T3 are not available in S contact version | | | | | | |

NOTES:

(1) Inserts are designed for rear release & rear removable contacts

(2) Pin and socket inserts can be installed in either plug or receptacle shell F6, F12C and 12F6 are only available in E class, Insert 00 is only available in N class

(3) For C-ENX A, C-ENX B1, C-ENX B3 and C-ENX B4 shells, use only insert keyed A (for C-ENX B2 shells, use one insert keyed A and one insert keyed B)

c-enx™ A INSERT ARRANGEMENTS ⁽³⁾



Insert Name 00
Insert Code 0
Blank insert⁽¹⁾

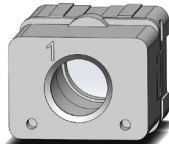

Insert Name 1C1
Insert Code A
1 x size 5 coax contact

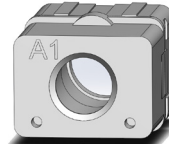

Insert Name 1P1
Insert Code B
1 x size 5 power contact

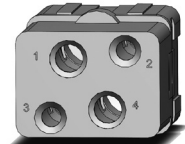

Insert Name 04
Insert Code C
2 x size 15 or 16 contacts
2 x size 12 contacts

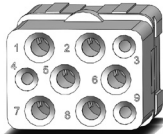

Insert Name 09
Insert Code D
3 x size 20 contacts
6 x size 15 or 16 contacts

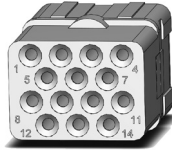

Insert Name 14
Insert Code E
14 x size 20 contacts



Insert Name 14M
Insert Code F
8 x size 22 contacts
3 x size 20 contacts
3 x size 15 or 16 contacts

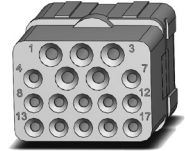

Insert Name 17
Insert Code G
12 x size 22 contacts
5 x size 20 contacts

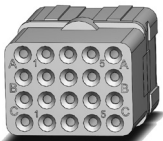

Insert Name 20
Insert Code H
20 x size 22 contacts

c-enx™ B INSERT ARRANGEMENTS ⁽³⁾

Full size inserts arrangements per EN 4644



Insert Name 00
Insert Code 0
Blank insert⁽²⁾

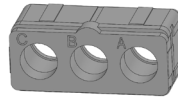

Insert Name C3
Insert Code A
3x size 5 coax contacts

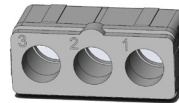

Insert Name P3
Insert Code B
3 x size 5 power contacts



Insert Name 3Q3
Insert Code C
3 x size 8 quadrax contacts

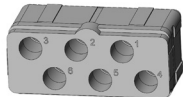

Insert Name 06
Insert Code D
6 x size 12 medium power contacts

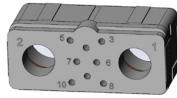

Insert Name 10Q2
Insert Code E
8 x size 20 contacts
2 x size 8 quadrax contacts

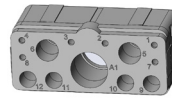

Insert Name 13C1
Insert Code H
6 x size 20 contacts
4 x size 15 or 16 contacts
2 x size 12 contacts
1 x size 5 coax contact

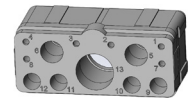

Insert Name 13P1
Insert Code J
6 x size 20 contacts
4 x size 15 or 16 contacts
2 x size 12 contacts
1 x size 5 power contact

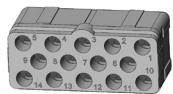

Insert Name 14
Insert Code K
14 x size 15 or 16 contacts

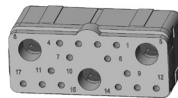

Insert Name 17
Insert Code L
14 x size 20 contacts
3 x size 12 contacts

NOTE: (1) P/N for blank insert is C-ENXAN00 (2) P/N for blank insert is C-ENXBN00 (3) Non-environmental inserts shown

c-enx™ B INSERT ARRANGEMENTS

Full size inserts arrangements per EN 4644

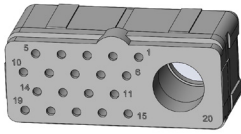

Insert Name 20C1
Insert Code M
 19 x size 20 contacts
 1 x size 5 coax contact

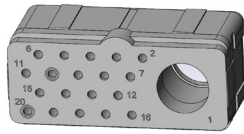

Insert Name 20P1
Insert Code N
 19 x size 20 contacts
 1 x size 5 power contact

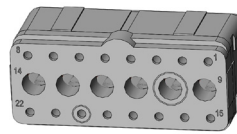

Insert Name 22
Insert Code P
 16 x size 20 contacts
 6 x size 15 or 16 contacts

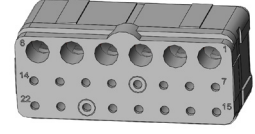

Insert Name 22V
Insert Code Q
 16 x size 20 contacts
 6 x size 16 contacts

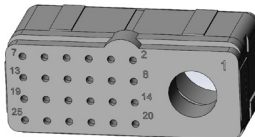

Insert Name 25P1
Insert Code R
 24 x size 22 contacts
 1 x size 8 power contact

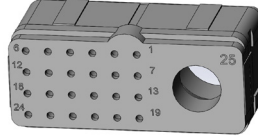

Insert Name 25Q1
Insert Code S
 24 x size 22 contacts
 1 x size 8 quadrax contact

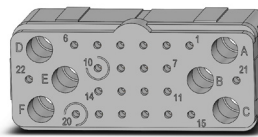

Insert Name 28
Insert Code T
 22 x size 22 contacts
 6 x size 15 or 16 contacts

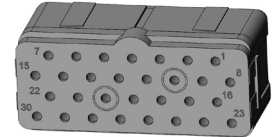

Insert Name 30
Insert Code U
 30 x size 20 contacts

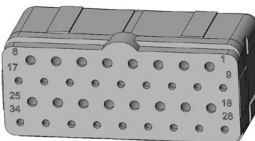

Insert Name 34
Insert Code W
 18 x size 22 contacts
 16 x size 20 contacts

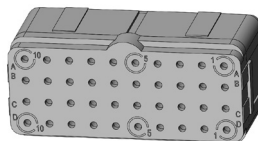

Insert Name 40
Insert Code X
 40 x size 22 contacts

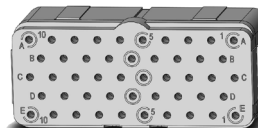

Insert Name 48
Insert Code Y
 48 x size 22 contacts

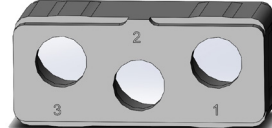

Insert Name 3T3 (1)
Insert Code Z
 3 x size 8 BMA pin contacts

NOTE:

(1) 3T3 pin insert only is available. It is mateable with 3Q3 socket insert

POWER & SIGNAL CRIMP CONTACTS

c-enx™ series is available in a wide range of contacts compliant with EN3155 and SAE AS 39029. Gold plating also available.

Contacts available in cable and PCB termination

- Power and signal contacts
- Coax, twinax and triax high frequency contacts
- Quadrx contact ethernet links

Benefits

- Significant cost reduction
- Decreased gold rate fluctuation dependence
- Contact crimping and soldering process does not change

Specifications

- Contact design identical to full plated version
- 1.27µm (50µin) gold plated contact interface
- Crimp version does not require crimping process changes
- Use of selective plated contacts on PC tail version does not impact PCB design
- Contact Cinch for product qualification information

| Contact Size | Wire Size (AWG) | Type | Part Number Full Plated | Part Number Selectively Plated | Crimping Tool | Positioner | Selector | Ins / ext Tool | Type of Tool | |
|--------------|--------------------------------------|--------|----------------------------------|--------------------------------|--|--------------------------|----------------------------|--------------------------------|----------------------------|---------|
| 22 | 22 | Pin | C-617200 | C-617200100 | C-282281 M22520/2-01 | C-282970 M22520/2-23 | 4 | C-282522 (M81969/14-01) | Plastic | |
| | 24 | | | | | | 3 | | | |
| | 26 | Socket | C-617300 | C-617300100 | | | 3 | | | |
| 20 | 20 | Pin | C-617221 | C-617221100 | C-282281 M22520/2-01 | C-282971 M22520/2-08 | 7 | C-282522001 (M81969/39-01)) | Plastic | |
| | 22 | | | | | | 6 | | | |
| | 24 | Socket | C-617320 | C-617320100 | | | 5 | | | |
| 16 | 16 | Pin | C-617240 | C-617240100 | C-282291 M22520/1-01 | C-282972 M22520/1-02 | 6 | C-282522001 (M81969/39-01) | Plastic | |
| | | 18 | Socket | C-617340 | | | C-617340100 | | | 5 |
| | | 20 | | | | | | | | 4 |
| | Ground block | 20 | Pin | C-617221050 | N/A | C-282281 M225520/2-01 | C-282581015 M22520/2-11 | 7 | C-282886 | Metal |
| | | | Socket | N/A | N/A | N/A | N/A | N/A | N/A | N/A |
| | for optical/ electrical insert | 16 | Pin | C-617235003(1) | N/A | C-282291 M22520/1-01 | C-282581013 | 6 | C-282515 (M81969/14-03) | Plastic |
| | | 18 | | | | | | 5 | | |
| 20 | | 4 | | | | | | | | |
| 12 | 12 | Pin | C-617250 | C-617250100 | C-282291 M22520/1-01 | C-282972 M22520/1-02 | 8 | C-282549004 (M81969/14-04) | Plastic | |
| | 14 | Socket | C-617350 | C-617350100 | | | 7 | | | |
| | 16 | | | | | | 6 | | | |
| 8 | 8 | Pin | C-617291002 ^(2&3) | N/A | C-R282600000 M22520/23-01 + Die set C-R282650000 M22520/23-02 | C-282588 | N/A | C-282549001 | Metal | |
| | 10 | Socket | C-617391002 ^(2&3) | N/A | | | N/A | | | |
| 5 | 8 | Pin | C-617280 ^(2&4) | N/A | C-282557020 | C-282557021 | N/A | C-282946 (M81969/28-01) | Metal | |
| | 10 | Socket | C-617390 ^(2&4) | N/A | | | N/A | | | |
| | 12 | Pin | C-617260001 ^(2&4) | N/A | C-282613 | C-282586003 | 6 | C-282946 (M81969/28-01) | Metal | |
| | 16 | Socket | C-617370001 ^(2&4) | N/A | | | 6 | | | |

NOTES:

- (1) Electrical contacts for optical inserts are always pin contacts (hermaphrodite)
- (2) In order to make these contacts environmental, it is necessary to add a sealing boot. Please contact us for additional information
- (3) These power contacts can be used in power inserts only (25P1)
- (4) These power contacts can be used in power inserts only (P3, 13P1 and 20P1)

OVERSIZED & REDUCED CRIMP BARREL CONTACTS

| Contact Size | Wire Size (AWG) | Type | Part Number Fully Plated | Crimping Tool | Positioner | Selector | Ins / ext Tool | Type of Tool | |
|--------------|--|------|--------------------------|-----------------|-------------------------|-------------------------|----------------|-------------------------------|---------|
| 22 | reduced crimp barrel | 28 | Pin | C-617201 (1) | C-282281 M22520/2-01 | C-282970 M22520/2-23 | 5 | C-282522 (M81969/14-01) | Plastic |
| | | 30 | Socket | C-617301(1) | | | 4 | | |
| | oversize crimp barrel | 20 | Pin | C-617200200 | C-282281 M22520/2-01 | C-282970 M22520/2-23 | 5 | C-282522 (M81969/14-01) | Plastic |
| | | 22 | Socket | C-617300200 | | | 4 | | Plastic |
| | | 24 | | | | | 3 | | Plastic |
| 20 | reduced crimp barrel | 22 | Pin | C-617224001 (1) | C-282281 M22520/2-01 | C-282970 M22520/2-23 | 4 | C-282522001 (M81969/39-01) | Plastic |
| | | 24 | Socket | C-617224001 (1) | | | 4 | | |
| | | 26 | | | | | 3 | | |
| | oversize crimp barrel | 18 | Pin | C-617221200 | C-282281 M22520/2-01 | C-282970 M22520/2-23 | 5 | C-282522001 (M81969/39-01) | Plastic |
| | | 20 | Socket | C-617320200 | | | 5 | | |
| | | 22 | | | | | 4 | | |
| 16 | reduced crimp barrel | 20 | Pin | C-617241 (1) | C-282291 M22520/1-01 | C-282972 M22520/1-02 | 5 | C-282515 (M81969/14-03) | Plastic |
| | | 22 | Socket | C-617341 (1) | | | 5 | | |
| | | 24 | | | | | 4 | | |
| | reduced crimp barrel for optical electrical insert | 20 | Pin | C-617235002 (2) | C-282291 M22520/1-01 | C-282581013 | 5 | C-282515 (M81969/14-03) | Plastic |
| | | 22 | | | | | 5 | | |
| | | 24 | | | | | 4 | | |
| | oversize crimp barrel | 14 | Pin | C-617240200 | C-282291 M22520/1-01 | C-282972 M22520/1-02 | 6 | C-282515 (M81969/14-03) | Plastic |
| | | 16 | Socket | C-617340200 | | | 5 | | |
| | | 18 | | | | | 5 | | |

NOTES:

(1) When smaller wire sizes are used on contacts with reduced crimp barrel, the wire will not provide sealing to the grommet.

If sealing is required, please contact Cinch.

(2) Electrical contacts for optical inserts are always pin contacts (hermaphrodite)

COAXIAL CRIMP CONTACTS

| Contact Size | Cable Type | Type | Environmental Part Number | Non-environmental Part Number | Ins/ext Tool | Type of Tool |
|--------------|---|--------|---------------------------|-------------------------------|-------------------------------|--------------|
| 15-16 | RG174-RG179 RG316 | Pin | C-617130 | C-617130 | C-282512 | Metal |
| | | Socket | C-617030 | C-617030 | | |
| | RG178 | Pin | C-617131 | C-617131 | | |
| | | Socket | C-617031 | C-617031 | | |
| | GORE/AXON P812817 FILECA F1703-134 FILOTEX SP132868 | Pin | C-617132 | C-617132 | | |
| | | Socket | C-617032 | C-617032 | | |
| | RG178 DT | Pin | C-617133 | C-617133 | | |
| | | Socket | C-617033 | C-617033 | | |
| | UT 047 | Pin | C-617135 | C-617135 | | |
| | | Socket | C-617035 | C-617035 | | |
| 12 | UT 085-RG405 | Pin | C-617160 | C-617160 | C-282549004 (M81969/14-04) | Plastic |
| | | Socket | C-617060 | C-617060 | | |
| 5 | RG58-RG141 | Pin | C-617101001 | C-617101 | C-282946 (M81969/28-01) | Metal |
| | | Socket | C-617001001 | C-617001 | | |
| | RG142 - RG400 | Pin | C-617102001 | C-617102 | | |
| | | Socket | C-617002001 | C-617002 | | |
| | RG174-RG316 RG188 | Pin | C-617103001 | C-617103 | | |
| | | Socket | C-617003001 | C-617003 | | |
| | RG178-RG196 | Pin | C-617104001 | C-617104 | | |
| | | Socket | C-617004001 | C-617004 | | |
| | RG180 | Pin | C-617105001 | C-617105 | | |
| | | Socket | C-617005001 | C-617005 | | |

TWINAX & TRIAX CRIMP CONTACTS

| Contact Size | Cable Type | Type | Environmental Part Number | Non-environmental Part Number | Ins/ext Tool | Type of Tool |
|--------------|-------------------------------------|--------|---------------------------|-------------------------------|-------------------------------|--------------|
| 12 Triax | ECS0700 | Pin | C-617190010 | C-617190010 | C-282549004 (M81969/14-04) | Plastic |
| | | Socket | C-617090010 | C-617090010 | C-282549004 (M81969/14-04) | Plastic |
| | M17/176-00002 | Pin | C-617190012 | C-617190012 | C-282549004 (M81969/14-04) | Plastic |
| | | Socket | C-617090012 | C-617090012 | C-282549004 (M81969/14-04) | Plastic |
| 8 Triax | TENSOLITE 24473/03159X-2 | Pin | C-617165021 | C-617165020 | C-282549001 | Metal |
| | | Socket | C-617065021 | C-617065020 | C-282549001 | Metal |
| | WHITMOR W26751575 | Pin | C-617165 | C-617165001 | C-282549001 | Metal |
| | | Socket | C-617065 | C-617065001 | C-282549001 | Metal |
| 8 Twinax | ABS0386WF24 & TYCO 1726A1424A | Pin | C-617165011 | C-620165010 | C-282549001 | Metal |
| | | Socket | C-617065011 | C-620065010 | C-282549001 | Metal |
| 5 Triax | M17/176-0002 | Pin | C-617150001 | C-617150 | C-282946 (M81969/28-01) | Metal |
| | | Socket | C-617050001 | C-617050 | C-282946 (M81969/28-01) | Metal |
| | PAN6421 | Pin | C-617152001 | C-617152 | C-282946 (M81969/28-01) | Metal |
| | | Socket | C-617052001 | C-617052 | C-282946 (M81969/28-01) | Metal |



QUADRAX & BMA CRIMP CONTACTS

Quadrax Contacts



| Contact Size | Cable Type | Type | Environmental Part Number | Non-environmental Part Number | Extraction Tool in Metal |
|--------------|-------------------------------------|--------|---------------------------|-------------------------------|--------------------------|
| 8 | Ethernet cable ABS0972 & ABS1503 | Pin | C-617175011 | C-617175012 | C-282549001 |
| | | Socket | C-617075011 | C-620075010 | |
| | TENSOLITE NF24Q100 | Pin | C-617175051 | C-617175052 | |
| | | Socket | C-617075051 | C-620075050 | |
| | Tensolite NF26Q100 JSF Y18 | Pin | C-617175053 | C-617175054 | |
| | | Socket | C-617075053 | C-620075021 | |

BMA Contacts

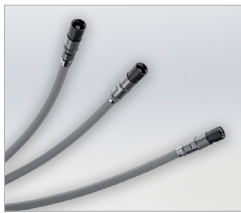

| Contact Size | Cable Type | Connector Type | Environmental Part Number | Non-environmental Part Number | Frequency Range | Max VSWR | Insertion Loss |
|--------------|--|--------------------|---------------------------|-------------------------------|-----------------|----------|-------------------------------------|
| 8 | SHF5 - SHF5M ⁽¹⁾ | Pin ⁽²⁾ | C-617171011 | C-617171010 | DC-18.0 GHz | 1.35 | 0.13 dB at max frequency (18.0 GHz) |
| | RG142 | Pin ⁽²⁾ | C-617171021 | C-617171020 | DC-12.4 GHz | 1.35 | 0.11 dB at max frequency (12.4 GHz) |
| | SHF2 4M ⁽¹⁾ /UT 0.085 Harbour SS405 Times Tflex405 | Pin ⁽²⁾ | C-617171031 | C-617171030 | DC-18.0 GHz | 1.35 | 0.13 dB at max frequency (18.0 GHz) |
| | SHF5 - SHF5M ⁽¹⁾ | Socket | C-617071011 | C-617071010 | DC-18.0 GHz | 1.35 | 0.13 dB at max frequency (18.0 GHz) |
| | RG142 | Socket | C-617071021 | C-617071020 | DC-12.4 GHz | 1.35 | 0.11 dB at max frequency (12.4 GHz) |
| | SHF3 ⁽¹⁾ | Socket | C-617071041 | C-617071040 | DC-18.0 GHz | 1.35 | 0.13 dB at max frequency (18.0 GHz) |

Extraction tool **282549001** is used for size 8 BMA contacts

Environmental BMA contacts are all provided with sealing boots

NOTES:

(1) The BMA contacts which can accommodate SHF cables requires a termination by Cinch

(2) BMA can only be installed in modified C-ENX B Quadrax insert such as 3T3P Ex: C-ENX B E3T3PA

Mechanical and Environmental Characteristics

| | Standard | Performances |
|-----------------------|----------------------------|---|
| Thermal cycling | SAE AS 13441 method 1003.1 | -55°C/+125°C (cable dependent) |
| Temperature endurance | TIA/EIA 455-4 | 1000 h @ 125°C (cable dependent) |
| Vibration | TIA/EIA 455-11 | 27 Grms |
| Shock | TIA/EIA 455-14 | 50 G, 11 ms |
| Durability | TIA/EIA 364-09 | 500 cycles (1) |
| Maintenance | SAE AS 13441 method 2002.1 | 10 cycles |
| Cable retention | | 68 N |
| 1.8 mm diameter | SAE AS 13441 method 2009.1 | 7 N |
| 900 µm diameter | | |
| Humidity | TIA EIA 455-5 | 10 cycles / 24 h 90% RH -25°C / +65°C |

NOTES:

(1) Mating cycles are dependent on connector series
Cinch can support you with your cable and harness assemblies
Please contact your Cinch sales representative

SIGNAL PC TAIL CONTACTS

Selection table for straight PC tail contacts

| Contact Termination | Contact Type | Size 22 | Size 20 | Size 16 | Size 12 | Size 8 | Size 5 |
|---------------------|--------------|--------------------------|-----------------------------|--------------------------|-----------------------------|-----------------------------|--------------------------|
| RA | Pin | C-617205510 | C-617222514 | C-617242510 | C-617259505 | C-617291501 | C-617289506 |
| | Socket | C-617305500 | C-617322505 | C-617342510 | C-617359505 | C-617391501 | C-617389506 |
| YA | Pin | C-617205010 | C-617222014 | C-617242010 | C-617259005 | C-617291001 | C-617289006 |
| | Socket | C-617305 | C-617322005 | C-617342010 | C-617359005 | C-617391001 | C-617389006 |
| ZA | Pin | C-617205710 | C-617222714 | C-617242710 | C-617259705 | C-617291701 | C-617289706 |
| | Socket | C-617305700 | C-617322705 | C-617342710 | C-617359705 | C-617391701 | C-617389706 |
| RB | Pin | C-617205501 | C-617222512 | C-617242508 | C-617259506 | C-617291503 | C-617289504 |
| | Socket | C-617305501 | C-617322506 | C-617342511 | C-617359506 | C-617391503 | C-617389504 |
| YB | Pin | C-617205001 | C-617222012 | C-617242008 | C-617259006 | C-617291003 | C-617289004 |
| | Socket | C-617305001 | C-617322006 | C-617342011 | C-617359006 | C-617391003 | C-617389004 |
| ZB | Pin | C-617205701 | C-617222712 | C-617242708 | C-617259706 | C-617291703 | C-617289704 |
| | Socket | C-617305701 | C-617322706 | C-617342711 | C-617359706 | C-617391703 | C-617389704 |
| RC | Pin | C-617205515 | C-617222513 | C-617242517 | C-617259503 | C-617291504 | C-617289503 |
| | Socket | C-617305508 | C-617322507 | C-617342513 | C-617359503 | C-617391504 | C-617389503 |
| YC | Pin | C-617205015 | C-617222013 | C-617242017 | C-617259003 | C-617291004 | C-617289003 |
| | Socket | C-617305008 | C-617322007 | C-617342013 | C-617359003 | C-617391004 | C-617389003 |
| ZC | Pin | C-617205715 | C-617222713 | C-617242717 | C-617259703 | C-617291704 | C-617289703 |
| | Socket | C-617305708 | C-617322707 | C-617342713 | C-617359703 | C-617391704 | C-617389703 |
| RD | Pin | C-617205509 | C-617222510 | C-617242509 | C-617259507 | C-617291505 | C-617289507 |
| | Socket | C-617305502 | C-617322509 | C-617342515 | C-617359507 | C-617391505 | C-617389507 |
| YD | Pin | C-617205009 | C-617222010 | C-617242009 | C-617259007 | C-617291005 | C-617289007 |
| | Socket | C-617305002 | C-617322009 | C-617342015 | C-617359007 | C-617391005 | C-617389007 |
| ZD | Pin | C-617205709 | C-617222710 | C-617242709 | C-617259707 | C-617291705 | C-617289707 |
| | Socket | C-617305702 | C-617322709 | C-617342715 | C-617359707 | C-617391705 | C-617389707 |
| Ins/ext. tool | | C-282522 M81969/14-01 | C-282522001 M81969/39-01 | C-282515 M81969/14-03 | C-282549004 M81969/14-04 | C-282549001 M81969/28-03 | C-282946 M81969/28-01 |

FILLER/SEALING PLUGS & QUADRAX SIZE 8 PC TAIL CONTACTS

Filler Plugs & Sealing Plugs

Sealing plugs are dedicated to environmental inserts and filler plugs are dedicated to non-environmental inserts.

| Contact Size | Filler Plug | Sealing Plug |
|--------------|-------------|--------------|
| Size 22 | C-620920 | C-616910 |
| Size 20 | C-610941 | C-616911 |
| Size 16 | C-620922 | C-616912 |
| Size 12 | C-620923 | C-616913 |
| Size 8 | Socket | C-619950 |
| Size 8 | Pin | C-619953 |
| Size 5 | Socket | C-617931 |
| Size 5 | Pin | C-617930 |

Selection table for straight PC tail contacts

| Contact Termination | Contact Type | Part Number Size 8 |
|---------------------|--------------|-----------------------|
| RA | Pin | C-617177512 |
| | Socket | C-617077512 |
| YA | Pin | C-617177012 |
| | Socket | C-617077012 |
| ZA | Pin | C-617177712 |
| | Socket | C-617077712 |
| RB | Pin | C-617177501 |
| | Socket | C-617077502 |
| YB | Pin | C-617177001 |
| | Socket | C-617077002 |
| ZB | Pin | C-617177701 |
| | Socket | C-617077702 |
| RC | Pin | C-617177508 |
| | Socket | C-617077508 |
| YC | Pin | C-617177008 |
| | Socket | C-617077008 |
| ZC | Pin | C-617177708 |
| | Socket | C-617077708 |
| RD | Pin | C-617177513 |
| | Socket | C-617077513 |
| YD | Pin | C-617177013 |
| | Socket | C-617077013 |
| ZD | Pin | C-617177713 |
| | Socket | C-617077713 |
| Extraction tool | | C-282549001 |



CONTACTS FOR GBE LINKS

Cinch's gigabit ethernet solutions deliver peak performance for applications requiring high speed transfers of digital, audio and video signals.

Quadrax Solution

- Available with all C-ENX B connectors
- One gigabit link requires two quadrax contacts
- Quadrax 3Q3 or 10Q2 inserts available
- Speeds up to 2 Gbit/sec

High Density Solution

- Available with all C-ENX B connectors
- One gigabit link requires four twisted pairs and eight #22 contacts
- 40 and 25Q1 inserts available
- Ensure ground continuity with additional size 22 contacts
- EMI backshell (recommended by Cinch)
- Speeds up to 1 Gbit/sec
- Short strip dimensions and easy maintenance availability are combined to get minimum impedance disturbance.

Contact Cinch customer service for additional information.

Detailed view of inserts including contacts for gigabit ethernet link.

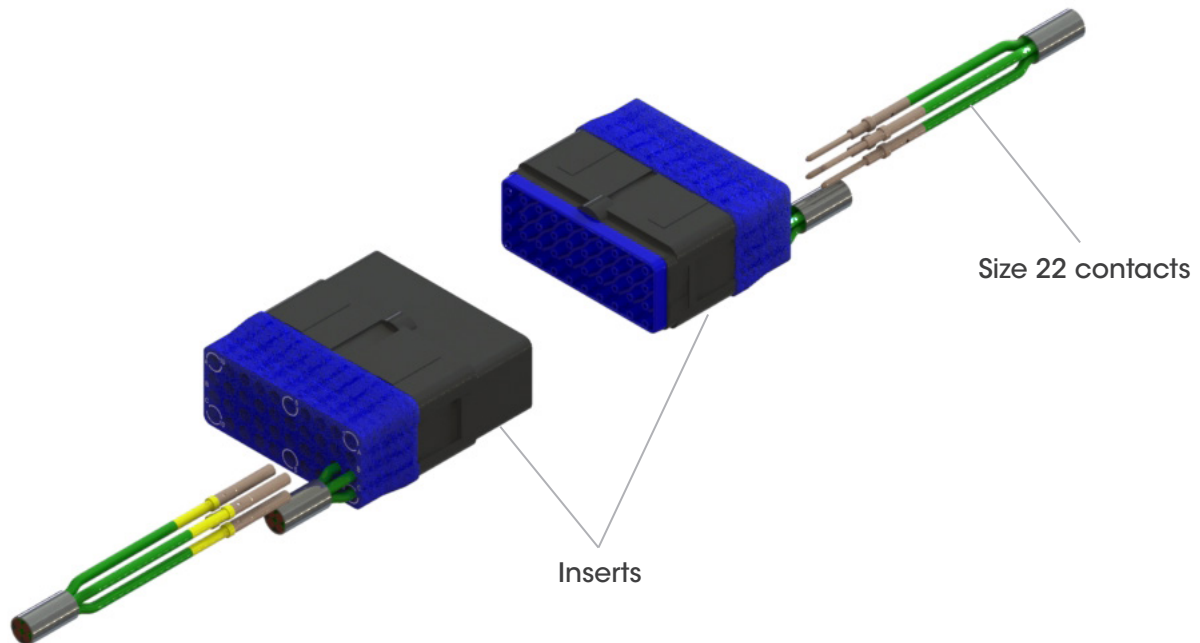

c-enx™ A & c-enx™ B1 PRODUCT OVERVIEW

Detailed view of receptacle and plug with accessories for the C-ENX A connector.

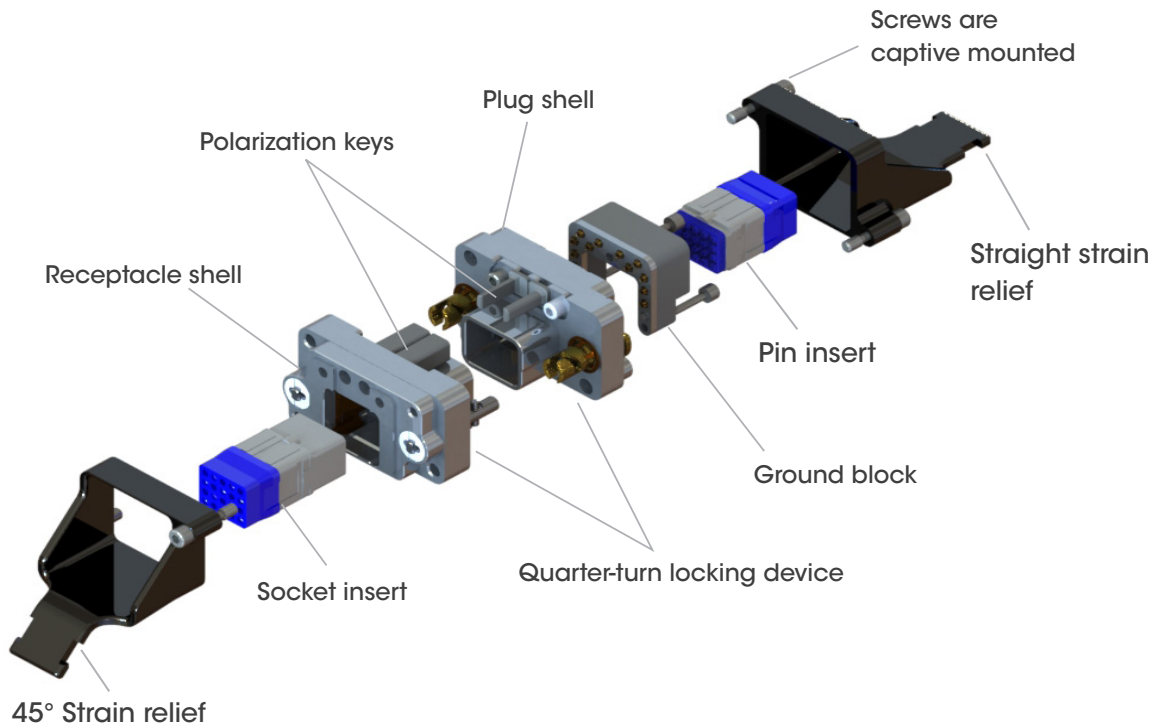

Detailed view of receptacle and plug with accessories for the C-ENX B1 connector.

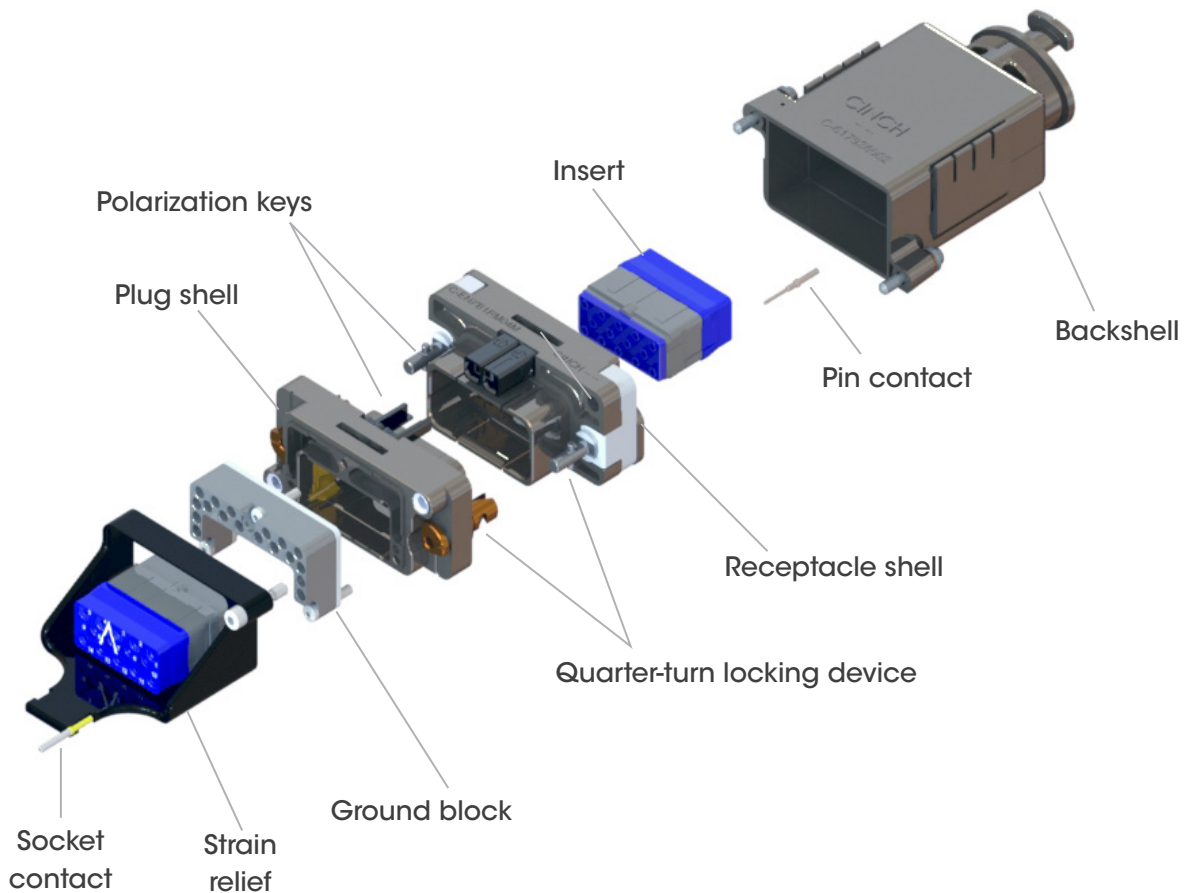

HOW TO ORDER c-enx™ A & c-enx™ B1 SHELL

| Series Prefix | C-ENX | B1 | P | B | 0 | 4 | M |
|--|-------|----|---|---|---|---|---|
| Cinch C-ENX™ Connector | | | | | | | |
| Shell size A1: Single small cavity shell B1: Single large cavity shell | | | | | | | |
| Shell style P: Plug R: Receptacle W: Plug with ground block Z: Receptacle with ground block and ground spring fingers | | | | | | | |
| Shell mounting option ⁽¹⁾ B: Plug without mounting holes M: Receptacle with 2 mounting holes 6-32 UNC for rear panel ⁽²⁾ | | | | | | | |
| Locking device 0: Quarter-turn fastener | | | | | | | |
| Polarization code ⁽³⁾ 4: Shell delivered with polarizing hardware unassembled 5: Shell delivered with no polarizing hardware | | | | | | | |
| Shell plating M: Nickel-plated composite for C-ENX B1 K: Nickel-plated Aluminum for C-ENX B1 (mateable with version M composite shell) N: Nickel-plated Aluminum for C-ENX A | | | | | | | |

NOTES:

- (1) Recommended locking torque: 1.6Nm (14.16 in-lbs) for metallic shell and 1.1Nm (9.73 in-lbs) max for composite shell
- (2) Self-locking mounting holes are designed for rear panel mounting
- (3) Please see page 29 on how to use the polarization device



HOW TO ORDER c-enx™ A & c-enx™ B1 ASSEMBLY KIT

| Shell Selection Part | C-ENX | B1 | R | 4 | M | E | M | YA |
|---|-------|----|---|---|---|---|---|----|
| Cinch C-ENX™ Connector | | | | | | | | |
| Shell size | | | | | | | | |
| A1: Single small cavity shell | | | | | | | | |
| B1: Single large cavity shell | | | | | | | | |
| Shell style | | | | | | | | |
| P: Plug | | | | | | | | |
| R: Receptacle | | | | | | | | |
| W: Plug with ground block | | | | | | | | |
| Z: Receptacle with ground block and ground fingers | | | | | | | | |
| Polarization code | | | | | | | | |
| 4: Shell delivered with polarizing hardware unassembled | | | | | | | | |
| 5: Shell delivered with no polarizing hardware | | | | | | | | |
| Shell plating | | | | | | | | |
| M: Nickel-plated composite for C-ENX B1 | | | | | | | | |
| K: Nickel-plated Aluminum for C-ENX B1 (mateable with version M composite shell) | | | | | | | | |
| N: Nickel-plated Aluminum for C-ENX A | | | | | | | | |
| Insert Selection Part | | | | | | | | |
| Insert class | | | | | | | | |
| E: Environmental | | | | | | | | |
| N: Non-environmental (no rear grommet, no interfacial seal) | | | | | | | | |
| H: Non-environmental insert with a rear grommet, available for pin insert only (recommended for crimp contact) | | | | | | | | |
| T: Non-environmental insert with an interfacial seal, available for pin insert only (recommended for PC tail contact) | | | | | | | | |
| Insert code | | | | | | | | |
| Refer to page 10 to select insert code | | | | | | | | |
| Contacts termination | | | | | | | | |
| XS: Socket insert without contacts | | | | | | | | |
| XP: Pin insert without contacts | | | | | | | | |
| SS: Socket insert with crimp contacts | | | | | | | | |
| SP: Pin insert with crimp contacts | | | | | | | | |
|] These contacts are delivered uninstalled | | | | | | | | |
| YA: Gold PC tail contacts length A | | | | | | | | |
| ZA: Tin-lead PC tail contacts length A | | | | | | | | |
| RA: Pure tin (RoHS) PC tail contacts length A | | | | | | | | |
|] Refer to page 26 to select PC tail contacts for receptacle | | | | | | | | |

Delivery includes fully assembled kit with insert mounted into shell. Contacts included only if specified in your order.

Tips to help you in your selection

- Pin or socket inserts may be used in C-ENX A & C-ENX B1 plug or receptacles.
- Crimp contacts available for delivery in a kit, see page 10.
- When PC tail is selected, all cavities are populated (including signal, power and quadrax). Size 5 coax cavities are not populated.
- PC tail contacts are available as pin straight PC tail contacts in receptacles only.

CONTACTS TERMINATION FOR c-enx™ B1

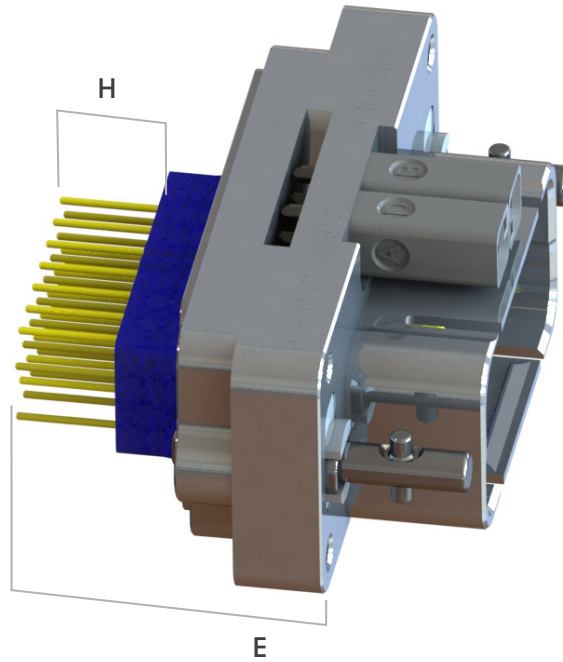

c-enx™ B1 Receptacles (Aluminum and composite shell version)

| Straight PC Tail contact termination | | | | |
|--------------------------------------|------------------------|------|----------|-----------------|
| Min Length E mm (inch) | Min Length H mm (inch) | Gold | Tin-lead | Pure Tin (RoHS) |
| 16.20 (0.637) ⁽¹⁾ | / | YA | ZA | RA |
| 19.40 (0.763) ⁽¹⁾ | / | YB | ZB | RB |
| 21.25 (0.836) ⁽¹⁾ | / | YC | ZC | RC |
| 25.20 (0.992) | 5.40 (0.212) | YD | ZD | RD |

NOTE:

(1) These PC tail lengths are not compatible with C-ENX BE and C-ENX BH inserts

c-enx™ A SHELL DIMENSIONS

WITHOUT GROUND BLOCK

Receptacle

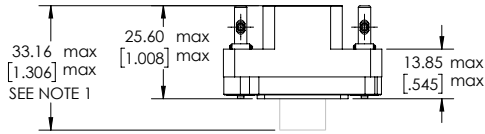

PANEL MOUNTING HOLES 2 x 6-32 UNC

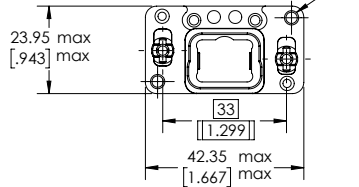

Plug

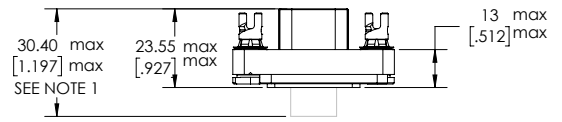

BACKSHELL MOUNTING HOLES

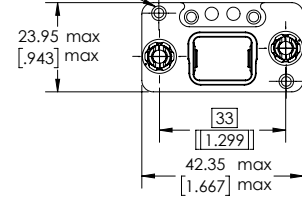

WITH GROUND BLOCK

Receptacle

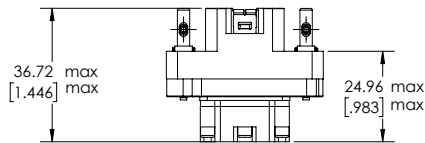

PANEL MOUNTING HOLES 2 x 6-32 UNC

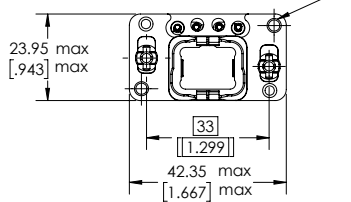

Plug

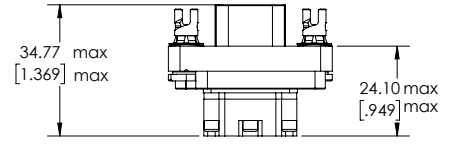

BACKSHELL MOUNTING HOLES

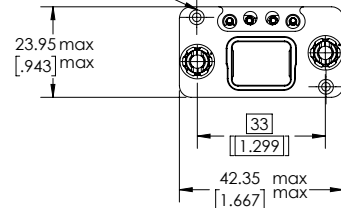

SINGLE PANEL CUT OUT (2)

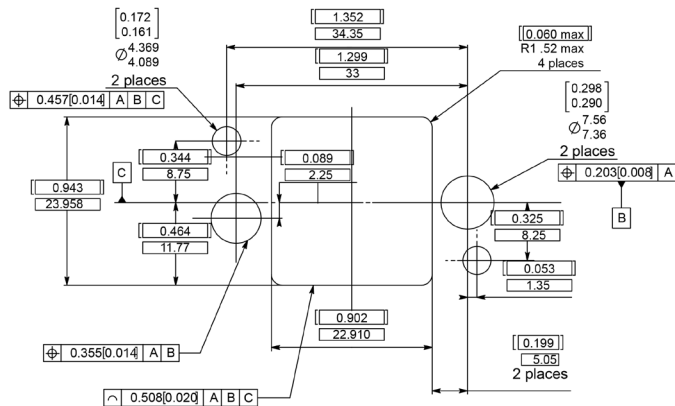

MULTIPLE PANEL CUT OUT (2)

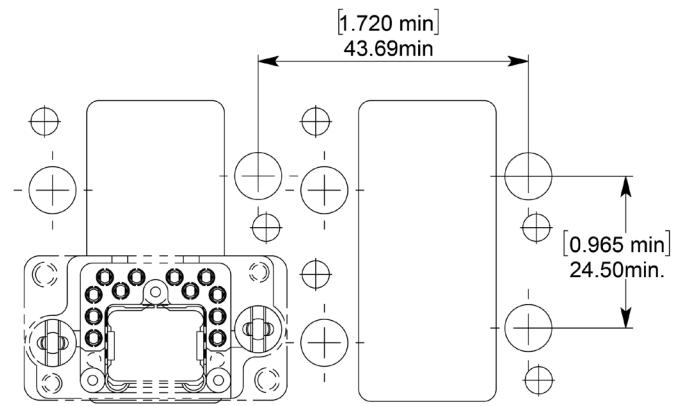

NOTES:

- (1) Maximum dimension for insert with grommets; for inserts without grommets maximum dimensions will be for receptacle 25.55mm (1.006in) and for the plug 23.52mm (0.926in) (2) Rear mounting panel view with key post oriented to the upper side

c-enx™ B1 SHELL DIMENSIONS

WITHOUT GROUND BLOCK

Receptacle

Plug

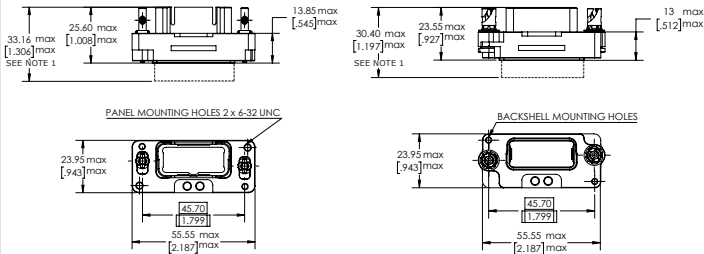

WITH GROUND BLOCK

Receptacle

Plug

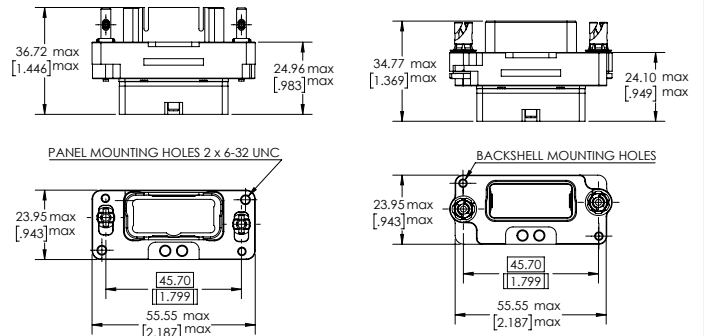

SINGLE PANEL CUT OUT (2)

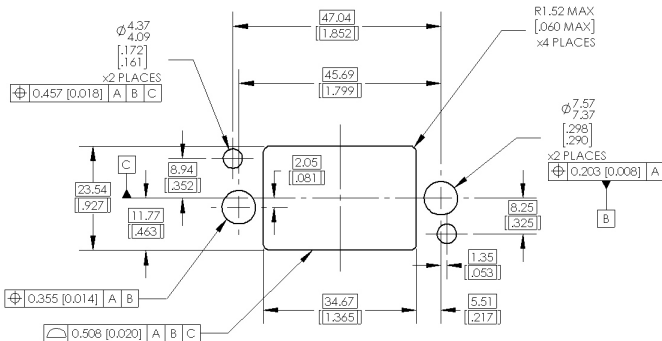

MULTIPLE PANEL CUT OUT (2)

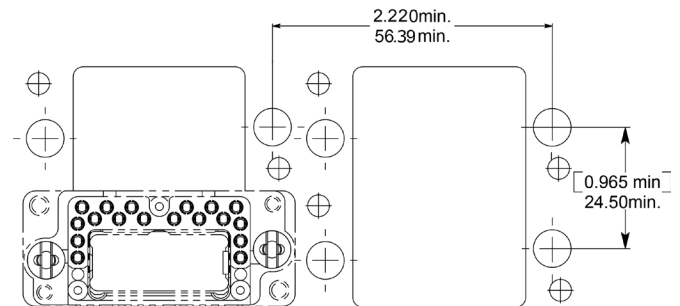

NOTES:

- (1) Maximum dimension for insert with grommets.
For inserts without grommets: Insert is flush to the shell.
Maximum dimension for the receptacle is 25.60 mm (1.006 in) and for the plug is 23.55 mm (0.926 in)
- For inserts with optical contacts: the maximum dimension for the receptacle is 38.70 mm (1.524 in) and the plug is 36.00 mm (1.418 in)
- (2) Rear mounting side view with key post oriented to the upper side

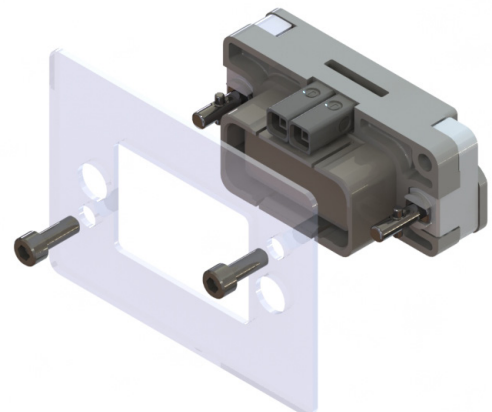

POLARIZATION CODE

Easy Reading of Polarization Code













Caution: Read the polarization code from left to right, the same way the part number marking can be read on the connector

| | Plug | Receptacle |
|---------------|------------------------------|------------------------------|
| C-ENX A | | |
| C-ENX B1 | | |
| Coding device | View A & B View C & D | View A & D View C & B |





| 16 possible codings: | | | | | | | | | | | | | | | | |
|----------------------|---|---|---|---|---|---|---|---|---|---|---|---|---|---|---|---|
| Key position 1 | A | A | A | A | B | B | B | B | C | C | C | C | D | D | D | D |
| Key position 2 | A | B | C | D | A | B | C | D | A | B | C | D | A | B | C | D |

c-enx™ A & c-enx™ B1 ACCESSORIES

Spare Parts & Dust Caps

| | Part number | | Description | Assembly Tool | Assembly Torque |
|---|-------------|-------------|---|---------------|----------------------|
| | C-ENX A | C-ENX B1 | | | |
|  | C-617980032 | - | Polarization kit for plug connector | C-282666002 | 0.8 Nm (7 In-lbs) |
|  | C-617980033 | - | Polarization kit for receptacle connector | C-282666002 | 0.8 Nm (7 In-lbs) |
|  | - | C-617980030 | Polarization post | N/A | N/A |
|  | - | C-617980031 | Polarization key | N/A | N/A |
|  | C-617954006 | C-617954008 | Dust cap for plug shell (pink color) | N/A | N/A |
|  | C-617954007 | C-617954009 | Dust cap for receptacle shell (pink color) | N/A | N/A |
|  | C-617954044 | C-617954034 | ESD dust cap for plug shell (black color) | N/A | N/A |
|  | C-617954045 | C-617954028 | ESD dust cap for receptacle shell (black color) | N/A | N/A |
|  | C-617929033 | - | Sealing inserts for fly away applications: mateable with pin insert | N/A | N/A |
|  | - | C-617929023 | Sealing inserts for fly away applications: mateable with pin insert | N/A | N/A |
|  | C-617929032 | - | Sealing inserts for fly away applications: mateable with socket insert | N/A | N/A |
|  | - | C-617929022 | Sealing inserts for fly away applications: mateable with socket insert | N/A | N/A |

Strain Relief and EMI Backshells

| | Part number | | Description | Assembly Tool | Assembly Torque |
|---|-------------|-------------|--|---------------|----------------------|
| | C-ENX A | C-ENX B1 | | | |
|  | C-617921030 | C-617921029 | Straight strain relief (composite) | C-282666002 | 0.8 Nm (7 In-lbs) |
|  | C-617921032 | C-617921031 | 45° strain relief (composite) | | |
|  | - | C-617921035 | Strain relief for fiber optic (anodized Aluminum) | | |
|  | - | C-617924016 | Straight EMI backshell (Nickel-plated Aluminum) | | |
|  | - | C-617928002 | Straight EMI backshell (Nickel-plated composite) | | |

NOTE: Contact Cinch for mounting instructions.

c-enx™ B2 DISCONNECT CONNECTORS

More for less

As industry demands high density and weight saving, connectors continue to grow in size. Cinch c-enx® B2 disconnect connectors are used in aerospace applications the world over. Cinch's engineering expertise designs and delivers innovative, effective and dependable solutions.

Weight Saving Offerings

Cinch offers cable to cable and PCB to cable connections available when design calls for lighter weight application

- C-ENX B2 class M (Nickel plated composite)

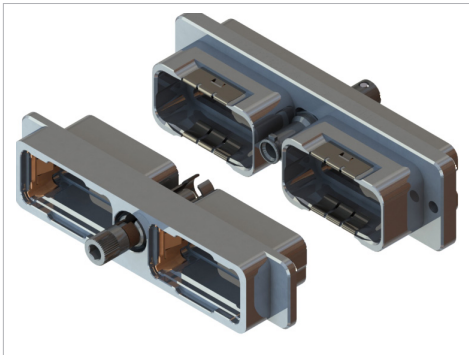

C-ENX B2 class N

Performances

- T° range -65°C / +175°C



C-ENX B2 class M

Performances

- Weight saving compared to class N C-ENX B2 : -15%

- T° range: -65°C / +125°C

c-enx™ B2 PRODUCT OVERVIEW

C-ENX B2 disconnect connector receptacle and plug with accessories.

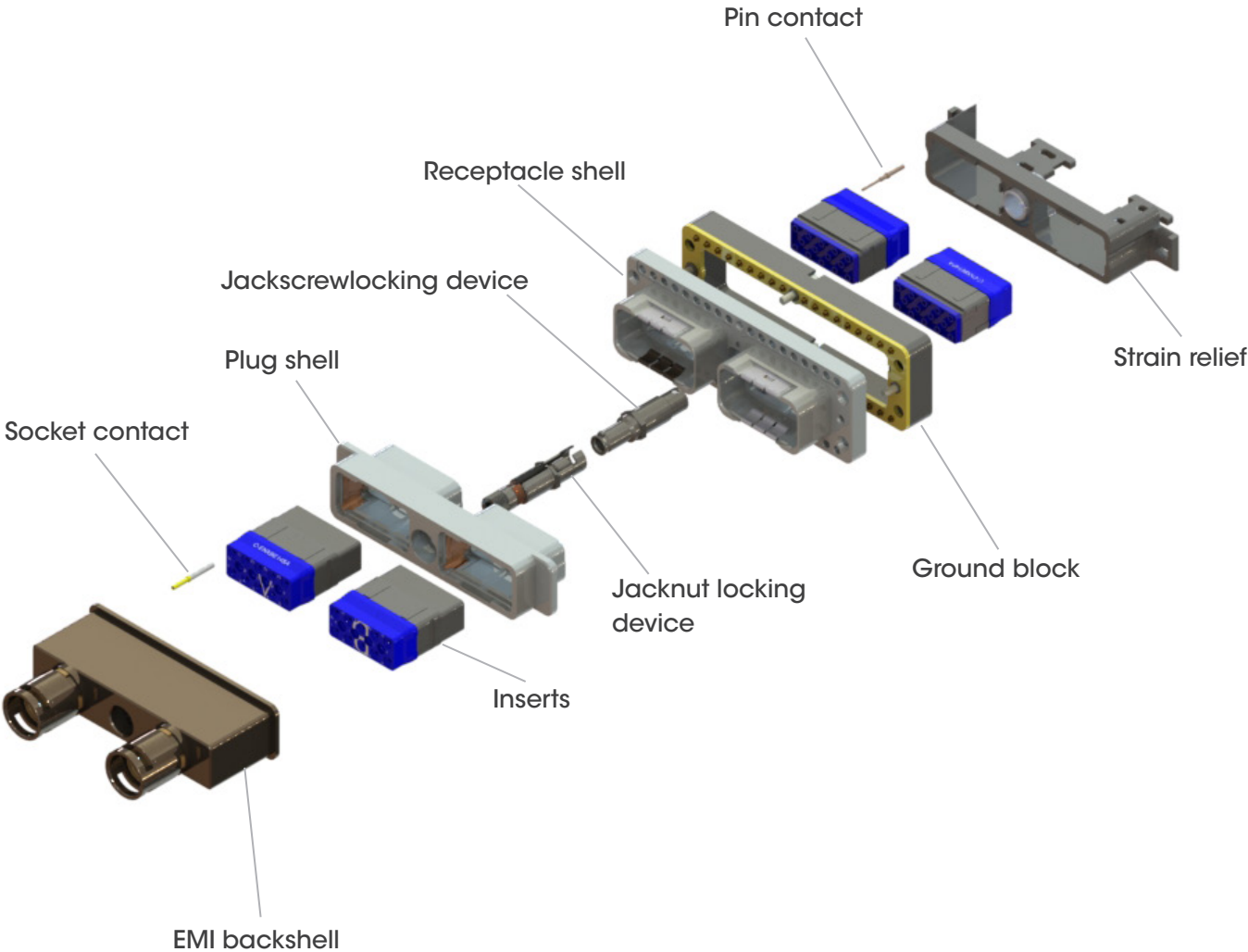

HOW TO ORDER c-enx™ B2 SHELL

| | | | | | | | |
|---|-------|----|---|---|---|---|---|
| Shell Selection Part | C-ENX | B2 | H | L | 2 | 2 | N |
| Cinch C-ENX™ Connector | | | | | | | |
| Shell size B2: Two cavity shell | | | | | | | |
| Shell style For option compatibility, see the table below L: Receptacle with flange and ground fingers H: Receptacle with ground fingers Z: Receptacle with ground block and ground fingers R: Receptacle without ground fingers P: Plug W: Plug with ground block | | | | | | | |
| Shell Mounting A: Panel rear mounted connector with 4 x 6-32 mounting holes B: No mounting holes D: Connector with 2 x Ø3.10 mm thru holes F: Panel rear mounted connector with 2 x 6-32 mounting holes L: Panel rear mounted connector with 2 x 4-40 mounting holes | | | | | | | |
| Locking & polarization device ⁽¹⁾ 1: Jackscrew 2: Jacknut 3: Without locking device 4: Pin centering guide for plug shell for LRU (Line Replaceable Unit) application only (2) 5: Socket centering guide for receptacle shell for LRU (Line Replaceable Unit) application only (2) | | | | | | | |
| Polarization code ⁽³⁾ 2: Polarizing device A to F delivered unassembled 3: Polarizing device N to Z delivered unassembled | | | | | | | |
| Shell plating N: Nickel-plated Aluminum M: Nickel-plated composite | | | | | | | |

Available Shell Mounting

| | Shell style | A (4 x 6-32 UNC) | B (no holes) | D (2 x Ø3.10mm) | F (2 x 6-32 UNC) | L (2 x 4-40 UNC) |
|---------------------|-------------|------------------|--------------|-----------------|------------------|------------------|
| Class N (Aluminum) | L | | | √ | √ | √ |
| | H | | √ | √ | √ | √ |
| | Z | √ | √ | | | |
| | R | √ | | | | |
| | P | | √ | √ | | √ |
| | W | √ | √ | | | |
| Class M (composite) | L | | | √ | | √ |
| | P | | √ | √ | | √ |

NOTES:

(1) Jackscrew/Jacknut can be mounted on either plug or receptacle shell. However, the standard options are:

- Jackscrew for plug shells
- Jacknut for receptacle shells

(2) Pin/Socket centering guides can be mounted on either plug or receptacle shells. However, the standard options are:

- Pin centering guide for plug shells
- Socket centering guide for receptacle shells

(3) Please see page 39 for how to use the polarization coding

HOW TO ORDER c-enx™ B2 ASSEMBLY KIT

| Shell Selection Part | C-ENX | B2 | H | B | 2 | N | N | BC | ZB |
|--|-------|----|--|---|---|---|---|----|----|
| Cinch C-ENX™ Connector | | | | | | | | | |
| Shell size B2: Two cavity shell | | | | | | | | | |
| Shell style For option compatibility, see table on page 1-36 L: Receptacle with flange and ground fingers H: Receptacle with ground fingers Z: Receptacle with ground block and ground fingers R: Receptacle without ground fingers P: Plug W: Plug with ground block | | | | | | | | | |
| Shell mounting A: Rear panel mounted connector with 4x 6-32 mounting holes B: No mounting holes D: Connector with 2 x Ø3.10 mm thru holes F: Rear panel mounted connector with 2 x 6-32 mounting holes L: Rear panel mounted connector with 2 x 4-40 mounting holes | | | | | | | | | |
| Polarization 1: Jackscrew polarizing device A to F 2: Jacknut polarizing device A to F 3: Without locking device 4: Pin centering guide for plug shell for LRU application only, polarizing device A to F 5: Socket centering guide for receptacle shell for LRU application only, polarizing device A to F 6: Jackscrew polarizing device N to Z 7: Jacknut polarizing device N to Z 8: Pin centering guide for plug shell for LRU application only, polarizing device N to Z 9: Socket centering guide for receptacle shell for LRU application only, polarizing device N to Z | | | | | | | | | |
| Shell plating N: Nickel-plated Aluminum M: Nickel-plated composite | | | | | | | | | |
| Insert Selection Part | | | | | | | | | |
| Insert class E: Environmental N: Non-environmental H: Non-environmental insert with a rear grommet, available for pin insert only (recommended for crimp contact) T: Non-environmental insert with interfacial seal, available for pin insert only (recommended for PC tail contact) | | | | | | | | | |
| Insert code Refer to page 10 to select code insert | | | | | | | | | |
| Contacts termination XS: Socket insert without contacts XP: Pin insert without contacts SS: Socket insert with crimp contacts SP: Pin insert with crimp contacts YA: Gold PC tail contacts length A ZA: Tin-lead PC tail contacts length A RA: Pure tin (RoHS) PC tail contacts length A | | | | | | | | | |
| | | |] These contacts are delivered uninstalled | | | | | | |
| | | |] Refer to page 35 to select PC tail contacts for receptacle | | | | | | |

Delivery includes fully assembled kit with insert mounted into shell. Contacts included only if specified in your order. Place insert codes in the order you want them assembled. Locking and polarizing devices are delivered uninstalled.

Tips to help you in your selection

- Pin or socket inserts may be used in C-ENX B2 plug or receptacle.
- Crimp contacts available for delivery in a kit, see page 10.
- When PC tail is selected, all cavities are populated (including signal, power and quadrax).
Size 5 coax cavities are not populated.
- PC tail contacts are available as pin straight PC tail contacts in receptacles only.

All connector inserts will use the same insert class and contact termination.

CONTACTS TERMINATION FOR RECEPTACLES

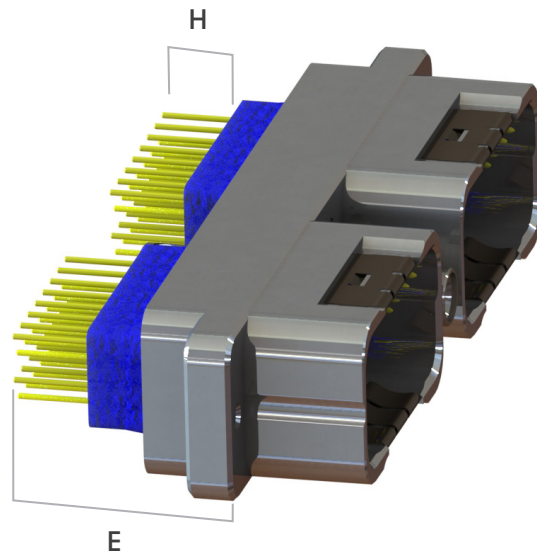

c-enx™ B2 Composite Shell

| Straight PC Tail contact termination | | | | | |
|--------------------------------------|------------------------|------|----------|-----------------|--|
| Min Length E mm (inch) | Min Length H mm (inch) | Gold | Tin-lead | Pure Tin (RoHS) | |
| 14.20 (0.559) (1) | / | YA | ZA | RA | |
| 17.35 (0.683) (1) | / | YB | ZB | RB | |
| 19.20 (0.755) (1) | / | YC | ZC | RC | |
| 23.10 (0.909) | 5.0 (0.212) | YD | ZD | RD | |

c-enx™ B2 Weight Optimized Aluminum and Aluminum Shell

| Straight PC Tail contact termination | | | | | |
|--------------------------------------|------------------------|------|----------|-----------------|--|
| Min Length E mm (inch) | Min Length H mm (inch) | Gold | Tin-lead | Pure Tin (RoHS) | |
| 14.55 (0.572) (1) | / | YA | ZA | RA | |
| 17.75 (0.698) (1) | / | YB | ZB | RB | |
| 19.55 (0.769) (1) | / | YC | ZC | RC | |
| 23.50 (0.925) | 5.40 (0.212) | YD | ZD | RD | |

NOTE:

(1) These PC tail lengths are not compatible with C-ENX BE and C-ENX BH inserts

c-enx™ B2 METALLIC SHELL DIMENSIONS

WITHOUT GROUND BLOCK CLASS N

Receptacle

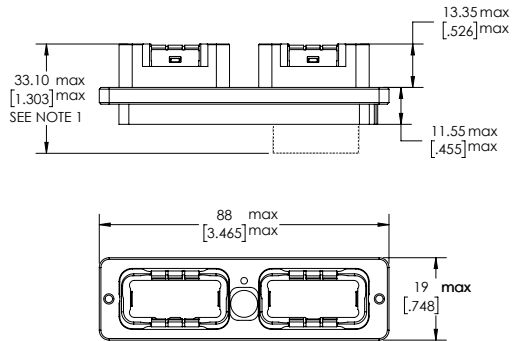

Plug

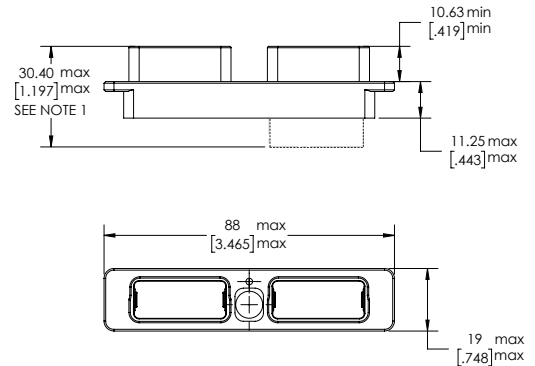

WITH GROUND BLOCK CLASS N

Receptacle

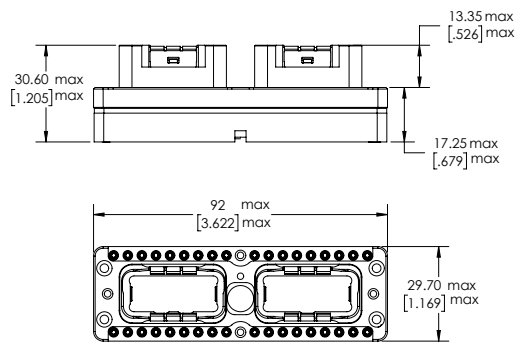

Plug

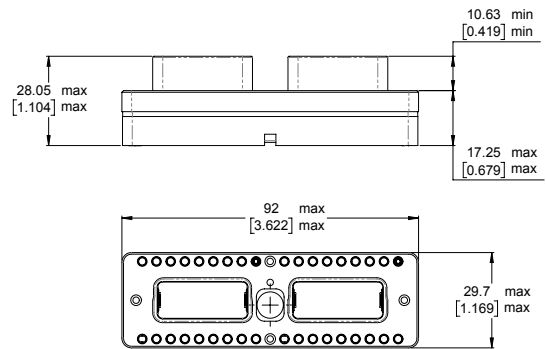

PANEL CUT OUT CLASS N

Shell mounting code D, F and L

Shell mounting code A

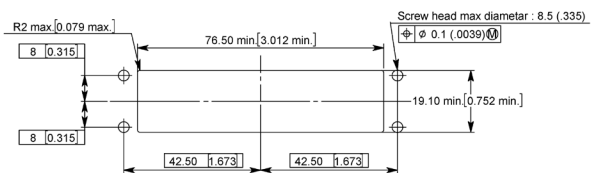
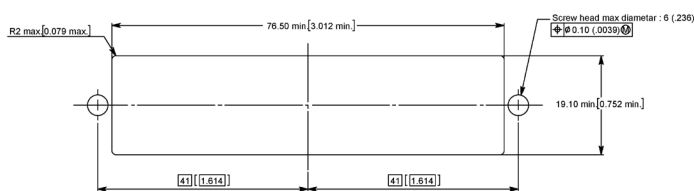

NOTES:

For inserts with grommets : maximum dimension is shown in the diagram

(1) For inserts without grommets: Insert is flush to the shell Maximum dimension for the receptacle is 25.55 mm (1.006 in) and for the plug is 23.52 mm (0.926 in)

For inserts with optical contacts : the maximum dimension for the receptacle is 38.70 mm (1.524 in) and for the plug is 36.00 mm (1.418 in)

C-ENX™ B2 COMPOSITE SHELL DIMENSIONS

PLUG

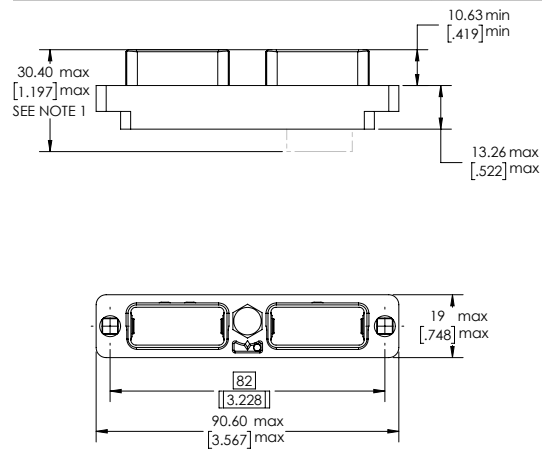

RECEPTACLE

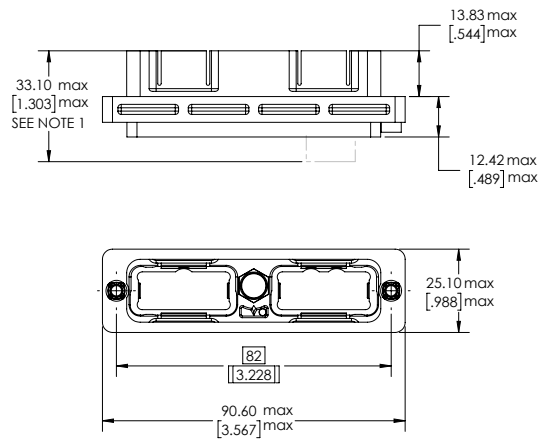

PANEL CUT OUT

Shell mounting code D and L

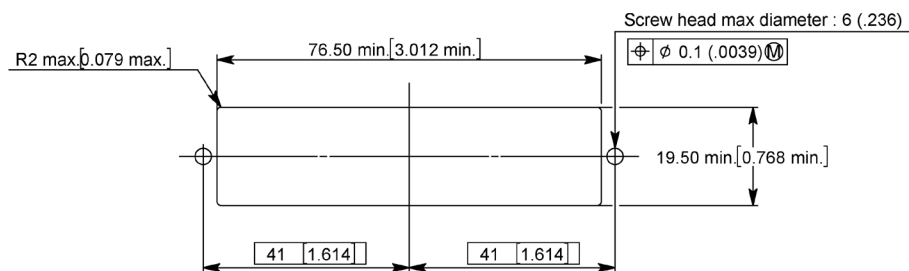

NOTE:

(1) For inserts with grommets (C-ENX BE and C-ENX BH) : maximum dimension is shown in the diagram

For inserts without grommets (C-ENX BN): Insert is flush to the shell

Maximum dimension for the receptacle is 25.55 mm (1.006 in) and for the plug is 23.52 mm (0.926 in)





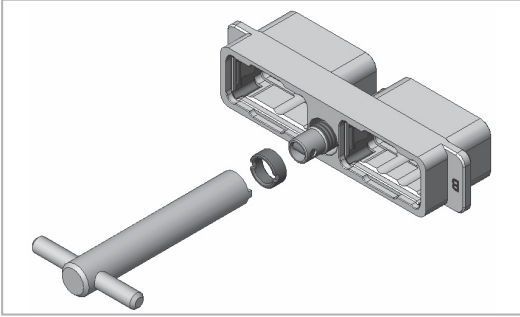





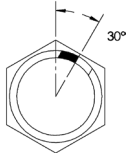

For inserts with optical contacts: the maximum dimension for the receptacle is 38.70 mm (1.524 in) and the plug is 36.00 mm (1.418 in)

c-enx™ B2 POLARIZATION CODE

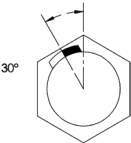

Jackscrews are installed in plugs and jacknuts in receptacle shells. Operator must lock the polarizing device at 1.2 Nm (10.62 Lb-In) for metallic shell and 0.8Nm (7.08 Lb-In) for composite shell. Use LOCTITE® 272 to assemble hardware components.

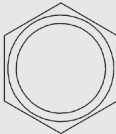
Nut may be fixed with an automatic screwdriver along with the tool bit we provide (PN C-282 664).

| Designation | Polarization Code | Coding Device Key | Part Number | |
|-------------|--|---|-------------|---|
| Jackscrew | From A to F |  | C-617980012 |  |
| | From N to Z 30° offset compared to the key of jackscrew P/N C-617980012 |  | C-617980013 |  |
| | Universal |  | C-617980023 |  |
| Jacknut | From A to F |  | C-617980029 |  |
| | From N to Z 30° offset compared to the key of jacknut C-617980029 |  | C-617980028 |  |
| | Universal |  | C-617980022 |  |

c-enx™ B2 POLARIZATION CODE

PLUG SHELL

Shell reference mark



- = Shell reference mark
- = Coding device key

| A | B | C | D | E | F |
|---|---|---|---|---|---|
| ○ | ○ | ○ | ○ | ○ | ○ |
| | | | | | |
| N | R | W | X | Y | Z |
| ○ | ○ | ○ | ○ | ○ | ○ |
| | | | | | |

RECEPTACLE SHELL

Shell reference mark



- = Shell reference mark
- = Coding device key

| A | B | C | D | E | F |
|---|---|---|---|---|---|
| ○ | ○ | ○ | ○ | ○ | ○ |
| | | | | | |
| N | R | W | X | Y | Z |
| ○ | ○ | ○ | ○ | ○ | ○ |
| | | | | | |

c-enx™ B2 ACCESSORIES

| | Part Number | Description | Assembly Tool ⁽²⁾ | Assembly Torque |
|---|-------------|---|---------------------------------------|-----------------------|
|  | C-617922007 | Straight strain relief (composite) | C-282664 or C-282665 | 0.8 Nm (7.08 in-lbs) |
|  | C-617922014 | Straight strain relief for fiber optic cable (anodized Aluminum) | C-282664 or C-282665 | 1.2 Nm (10.62 in-lbs) |
|  | C-617928100 | Straight EMI backshell (nickel-plated composite) | Allen wrench 1/4 inch | 1.2 Nm (10.62 in-lbs) |
|  | C-617925052 | EMI backshell for braid shield termination (nickel-plated Aluminum) | C-282664 or C-282665 | 1.2 Nm (10.62 in-lbs) |
|  | C-617925054 | EMI backshell for screened twisted pair cables (nickel-plated Aluminum) | C-282664 or C-282665 | 1.2 Nm (10.62 in-lbs) |
|  | C-617925056 | Backshell for large sized wire harnesses (nickel-plated Aluminum) (1) | C-282664 or C-282665 and Allen wrench | 1.2 Nm (10.62 in-lbs) |







NOTE: (1) Not compatible with jackscrew (2) For more details, refer to page 42

c-enx™ B2 SPARE PARTS

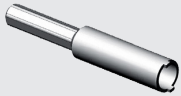
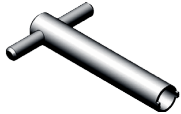
| | Part Number | Description |
|---|-------------|--|
|  | C-617954101 | Grounding spring (for C-ENX B2 Aluminum only) |
|  | C-617980029 | Jacknut – A/B/C/D/E/F |
| | C-617980028 | Jacknut – N/R/W/X/Y/Z |
| | C-617980022 | Universal jacknut |
|  | C-617980012 | Jackscrew – A/B/C/D/E/F |
| | C-617980013 | Jackscrew – N/R/W/X/Y/Z |
| | C-617980023 | Universal jackscrew |
|  | C-617954002 | Dust cap for plug shell (pink color) |
| | C-617954003 | Dust cap for receptacle shell (pink color) |
| | C-617954004 | ESD dust cap plug shell (black color) |
| | C-617954005 | ESD dust cap receptacle shell (black color) |

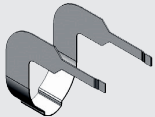
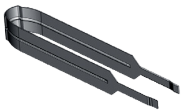
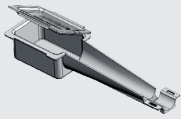

TOOLS

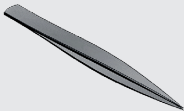
| | Part Number | Description | To be Used With | | |
|---|--------------|---|-----------------|----------|----------|
| | | | C-ENX A | C-ENX B1 | C-ENX B2 |
|  | C-282664 | 1/4 inch hex screwdriver bit to affix the nut of the jackscrew or the jacknut to the C-ENX B2 accessories | | | X |
|  | C-282665 | Spigot wrench to affix the nut of the jackscrew or the jacknut to the C-ENX B2 accessories | | | X |
|  | C-282666 | Allen wrench for 1/4 turn fastener (3/32 inch) | X | X | |
|  | C-282666002 | Allen wrench for rear accessories (5/64 inch) | | X | |
|  | C-282666001 | Allen wrench for jackscrew (9/64 inch) | | | X |
|  | C-282521002 | Insert extraction tool | | X | X |
|  | C-282521004 | Right angle insert extraction tool | | X | X |
|  | C-282521005 | Insert extraction tool | X | | |
|  | C-617954020 | Plastic box to protect wired inserts during handling | X | X | X |
|  | C-F780855000 | Hexagonal key 2mm (5/64inch) Flats for sleeve holder removal | | X | X |
|  | C-282668001 | Tweezers to change polarizing posts and keys | | X | |

c-enx™ B1 PRODUCT OVERVIEW

C-ENX B1 rack and panel connector receptacle and plug with accessories.

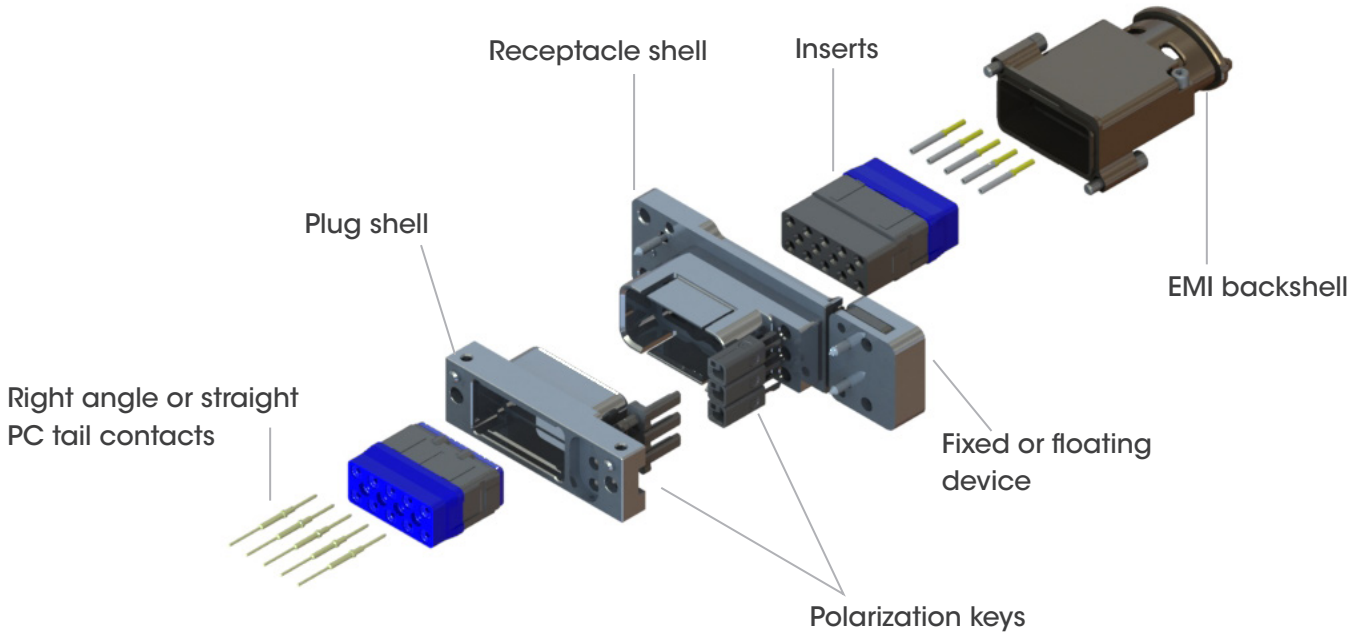

c-enx™ B2 PRODUCT OVERVIEW

Detailed view of receptacle and plug with accessories for the C-ENX B2 rack and panel connector.

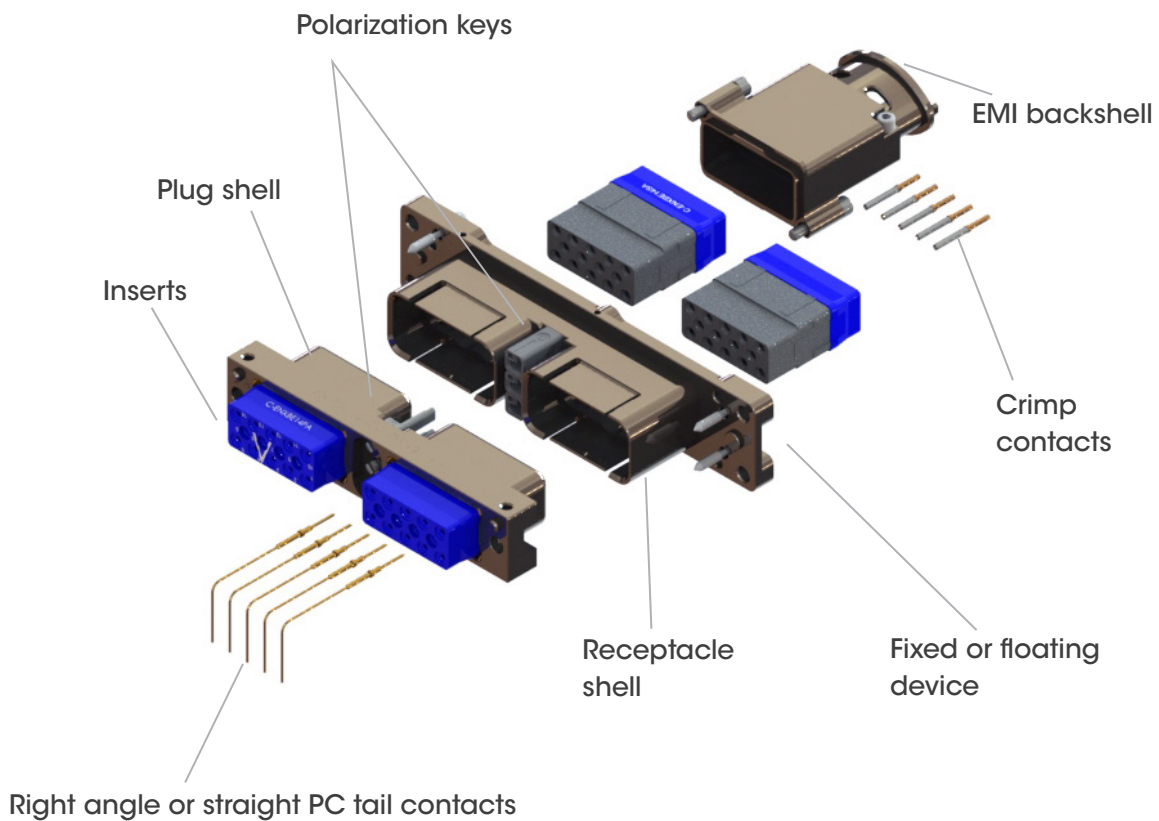

c-enx™ B3 PRODUCT OVERVIEW

C-ENX B3 rack and panel connector receptacle and plug with accessories.

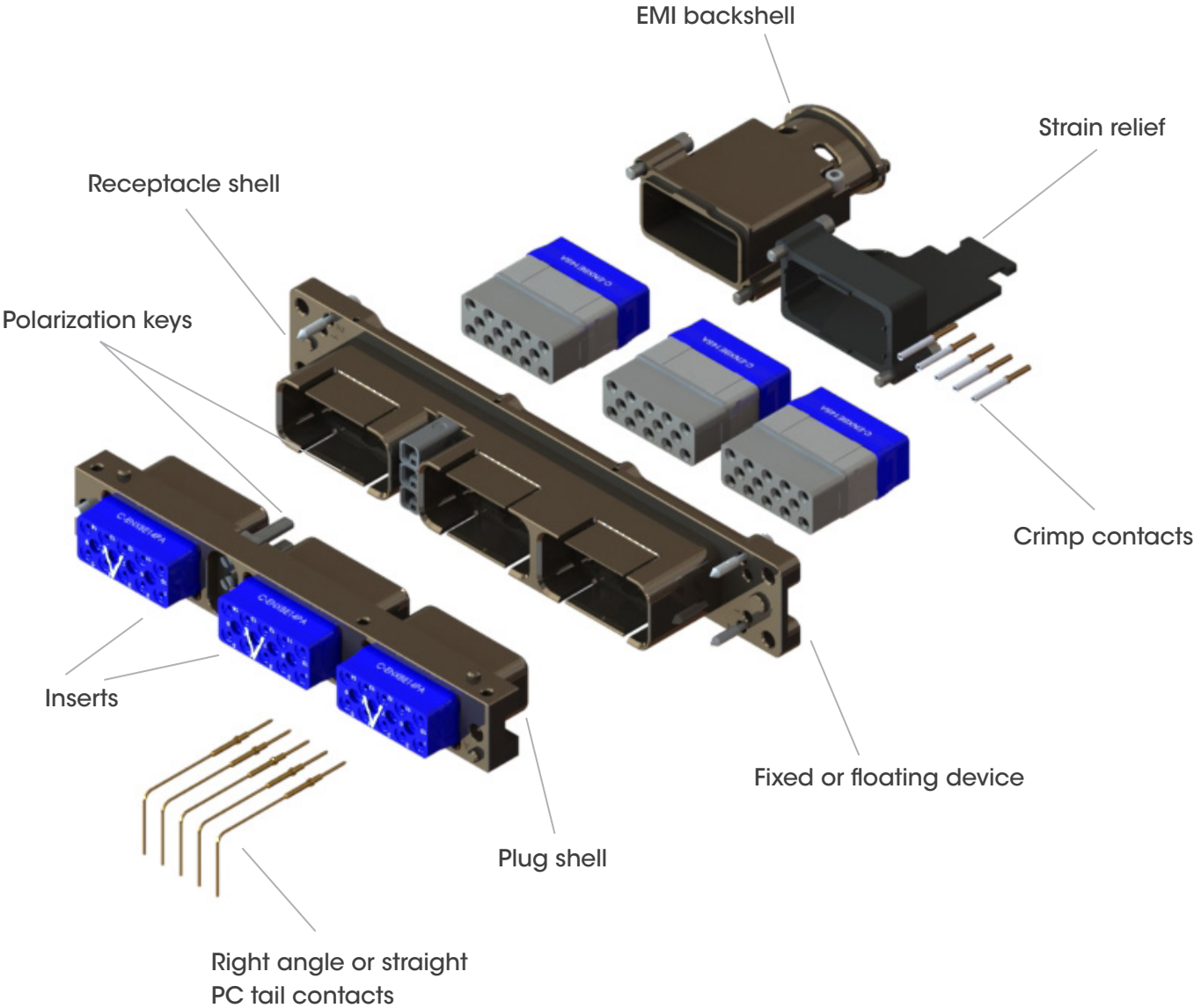

c-enx™ B4 PRODUCT OVERVIEW

C-ENX B4 rack and panel connector receptacle and plug with accessories.

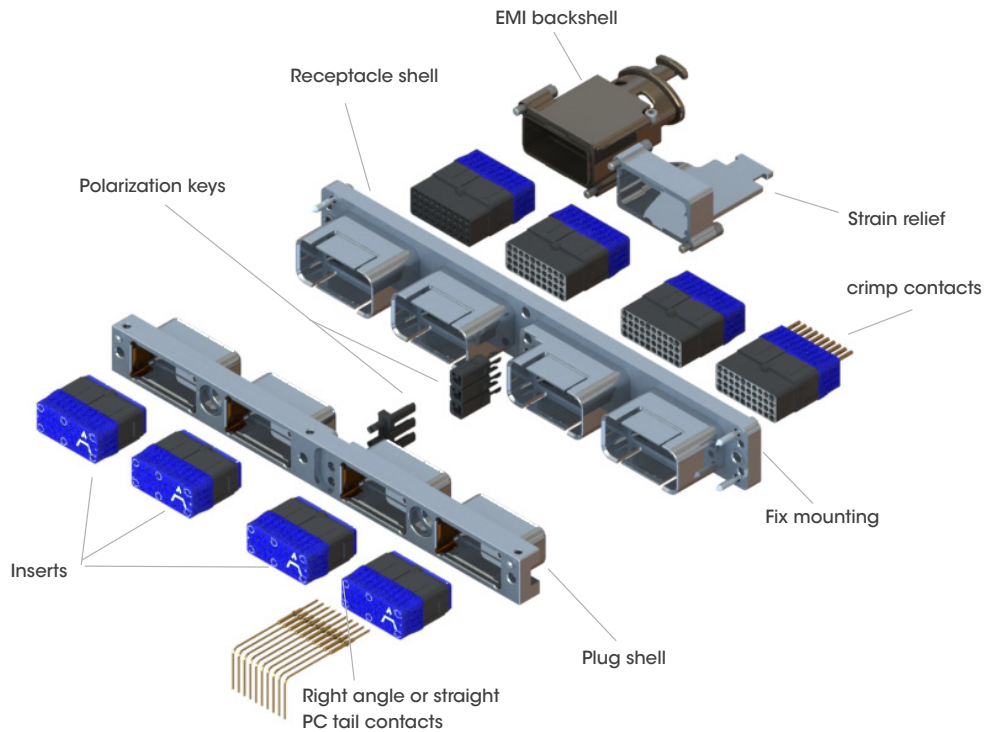

HOW TO ORDER c-enx® B1, B2, B3 & B4 SHELL

| Shell Selection Part | C-ENX | B3 | P | N | 1 | 0 |
|---|-------|----|---|---|---|---|
| Cinch C-ENX™ Connector | | | | | | |
| Shell size | | | | | | |
| B1: One cavity shell | | | | | | |
| B2: Two cavity shell | | | | | | |
| B3: Three cavity shell | | | | | | |
| B4: Four cavity shell | | | | | | |
| Shell style | | | | | | |
| P: Plug, nickel-plated | | | | | | |
| R: Receptacle, nickel-plated | | | | | | |
| Shell mounting | | | | | | |
| (refer to page 42 for coding) | | | | | | |
| M: Plug, fixed connector with Ø3.96mm holes & 4-40UNC on side | | | | | | |
| N: Plug, fixed connector with 8-32 UNC & 4-40UNC on side | | | | | | |
| S: Receptacle, fixed with 4 x 8-32UNC | | | | | | |
| T: Receptacle, two axis floating with 4 x 8-32 UNC (1) | | | | | | |
| Polarization Code | | | | | | |
| 1: Shell delivered with polarizing keys unassembled | | | | | | |
| 2: Shell delivered with no polarizing keys | | | | | | |
| Panel cut-out coding | | | | | | |
| A to Z: Receptacle, refer to page 52 for the code selection | | | | | | |
| 0 (zero): Plug, no panel cut out coding | | | | | | |

NOTE: (1) This floating option is not available in C-ENX B4 version

HOW TO ORDER c-enx™ B1, c-enx™ B2, B3 & B4 ASSEMBLY KIT

| Shell Selection Part | C-ENX | B4 | P | N | 0 | E | ABCD | YA |
|---|-------|----|---|---|---|---|------|----|
| Cinch C-ENX™ Connector | | | | | | | | |
| Shell size | | | | | | | | |
| B1: One cavity shell | | | | | | | | |
| B2: Two cavity shell | | | | | | | | |
| B3: Three cavity shell | | | | | | | | |
| B4: Four cavity shell | | | | | | | | |
| Shell style | | | | | | | | |
| P: Plug, nickel-plated | | | | | | | | |
| R: Receptacle, nickel-plated | | | | | | | | |
| Shell mounting (refer to page 47 for codes) | | | | | | | | |
| M: Plug, fixed connector with Ø3.96mm holes & 4-40UNC on side | | | | | | | | |
| N: Plug, fixed connector with 8-32 UNC & 4-40 UNC on side | | | | | | | | |
| S: Receptacle, fixed with 4 x 8-32 UNC | | | | | | | | |
| T: Receptacle, two axis floating with 4 x 8-32 UNC (1) | | | | | | | | |
| Panel cut-out coding | | | | | | | | |
| A to Z: For receptacle, refer to page 52 for the code selection | | | | | | | | |
| 0 (zero): For plug, no panel cut out coding | | | | | | | | |
| Insert Selection Part | | | | | | | | |
| Insert class | | | | | | | | |
| E: Environmental | | | | | | | | |
| N: Non-environmental (no rear grommet, no interfacial seal) | | | | | | | | |
| H: Non-environmental insert with a rear grommet (recommended for crimp contact) | | | | | | | | |
| T: Non-environmental insert with interfacial seal (recommended for PC tail contact) | | | | | | | | |
| Insert code | | | | | | | | |
| Refer to page 10 to select code insert | | | | | | | | |
| Contacts termination | | | | | | | | |
| XS: Female insert without contacts | | | | | | | | |
| XP: Male insert without contacts | | | | | | | | |
| SS: Female insert with crimp contacts | | | | | | | | |
| SP: Male insert with crimp contacts | | | | | | | | |
|] These contacts are delivered uninstalled | | | | | | | | |
| YA: Gold PC tail contacts length A | | | | | | | | |
| ZA: Tin-lead PC tail contacts length A | | | | | | | | |
| RA: Pure tin (RoHS) PC tail contacts length A | | | | | | | | |
|] Refer to page 47 to select PC tail contacts for plug | | | | | | | | |

Delivery includes fully assembled kit with insert mounted into shell. Contacts included only if specified in your order. Place insert codes in the order you want them assembled. Locking and polarizing devices are delivered uninstalled.

Tips to help you in your selection

- Pin or socket inserts may be used in C-ENX B1, B2, B3, B4 plug or receptacles.
- Crimp contacts available for delivery in a kit, see page 10.
- When PC tail is selected, all cavities are populated (including signal, power and quadrx). Size 5 coax cavities are not populated.
- PC tail contacts are available as pin straight PC tail contacts in receptacles only.

All connector inserts will use the same insert class and contact termination.

NOTE: (1) This floating option is not available in C-ENX B4 version

CONTACTS TERMINATION FOR C-ENX B1, C-ENX B2, C-ENX B3 and C-ENX B4 Plugs

| Straight PC Tail contact termination | | | | |
|--------------------------------------|----------------------------|------|----------|--------------------|
| Mini Length E mm (inch) | Mini Length H mm (inch) | Gold | Tin-lead | Pure Tin (RoHS) |
| 10.60 (0.417) (1) | / | YA | ZA | RA |
| 13.80 (0.543) (1) | / | YB | ZB | RB |
| 15.60 (0.614) (1) | / | YC | ZC | RC |
| 19.55 (0.769) | 5.40 (0.212) | YD | ZD | RD |

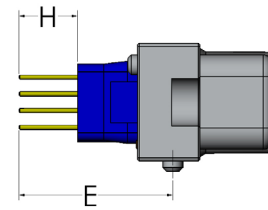

| Right Angle PC Tail contact termination ⁽²⁾ | | | | |
|--|---------------------------|------|----------|--------------------|
| Mini Length F mm (inch) | Mini Length Emm (inch) | Gold | Tin-lead | Pure Tin (RoHS) |
| 2.20 (0.086) | 12.85 (0.505) (1) | GA | LA | TA |
| 3.60 (0.141) | 20.10 (0.791) | GB | LB | TB |
| 3.60 (0.141) | 12.85 (0.505) (1) | GC | LC | TC |
| 2.20 (0.141) | 20.10 (0.791) | GD | LD | TD |

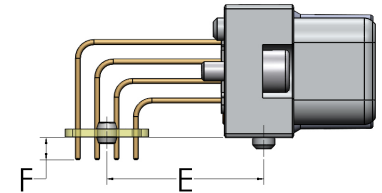

c-enx™ B Shell Mounting

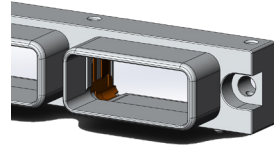
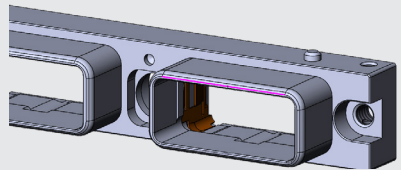
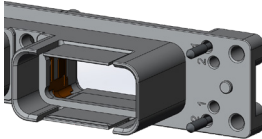
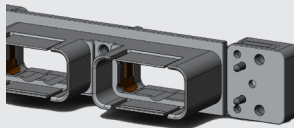
| Receptacle Side | Code | Plug Sides |
|---|------|---|
| N/A | M | Fixed connector with Ø 3.96 mm holes & 4-40 UNC front or side mount |
|  | | |
| N/A | N | Connector with 8-32 UNC & 4-40 UNC front or side mount |
|  | | |
| Fixed with 4 x 8-32 UNC panel rear mount | S | N/A |
|  | | |
| Floating with 4 x 8-32 UNC panel rear mount | T | N/A |
|  | | |

NOTES:

(1) These PC tail lengths are not compatible with C-ENX BE and C-ENX BH inserts

(2) Right angle PC tail lengths GA, LA, TA and GD, LD, TD are not available for #5 and #8 power contacts

c-enx™ B1 SHELL DIMENSIONS & PANEL CUT-OUTS

RECEPTACLE

Fixed Mount

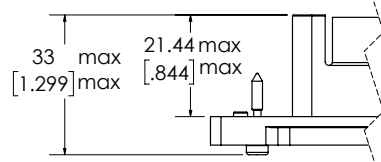

Floating Mount

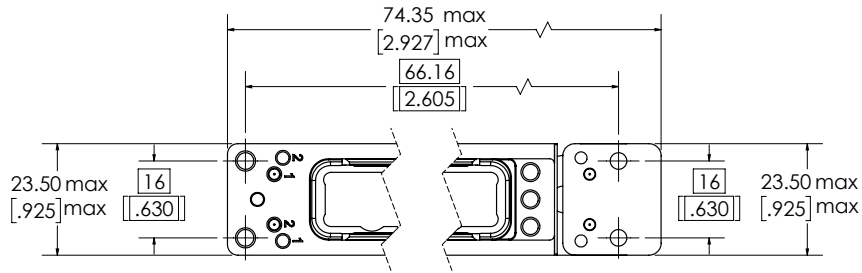
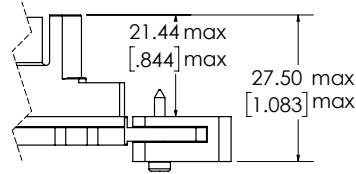

PLUG

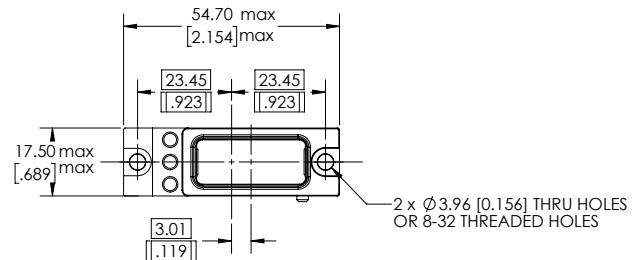
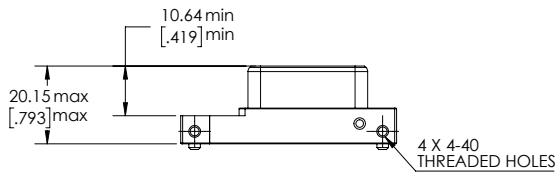

PANEL CUT OUT (1)

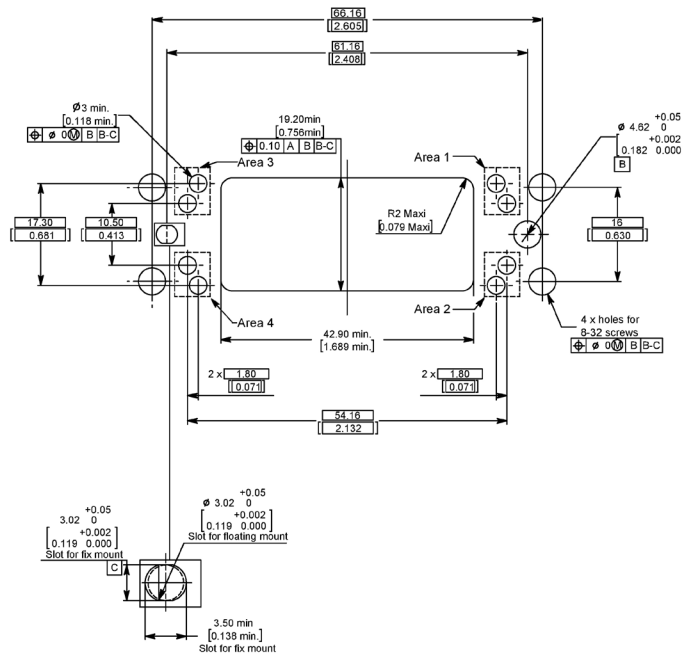

NOTE:

(1) The panel cut-out is shown from the rear of the panel

c-enx™ B2 SHELL DIMENSIONS & PANEL CUT-OUTS

RECEPTACLE

Floating Mount

Fixed Mount

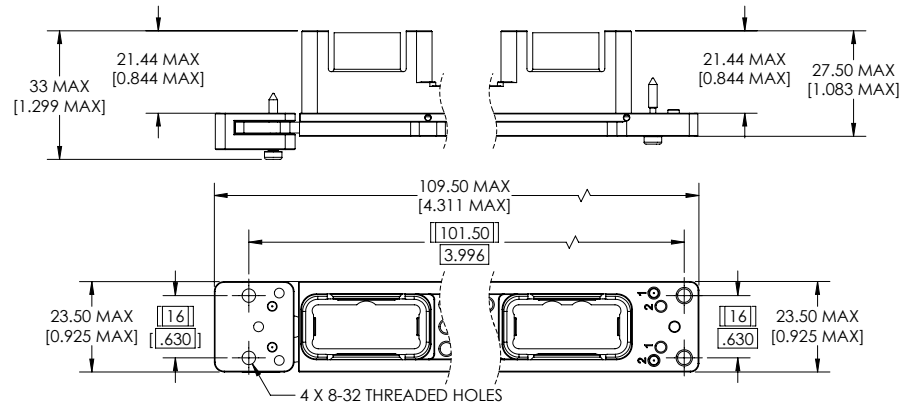

PLUG

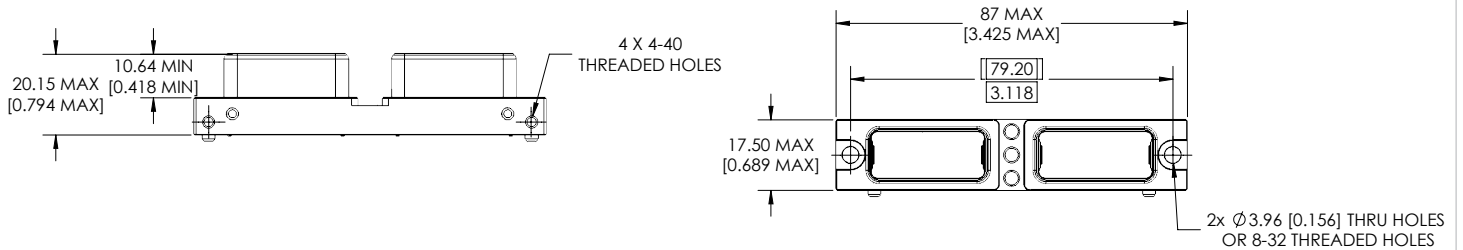

PANEL CUT OUT (1)

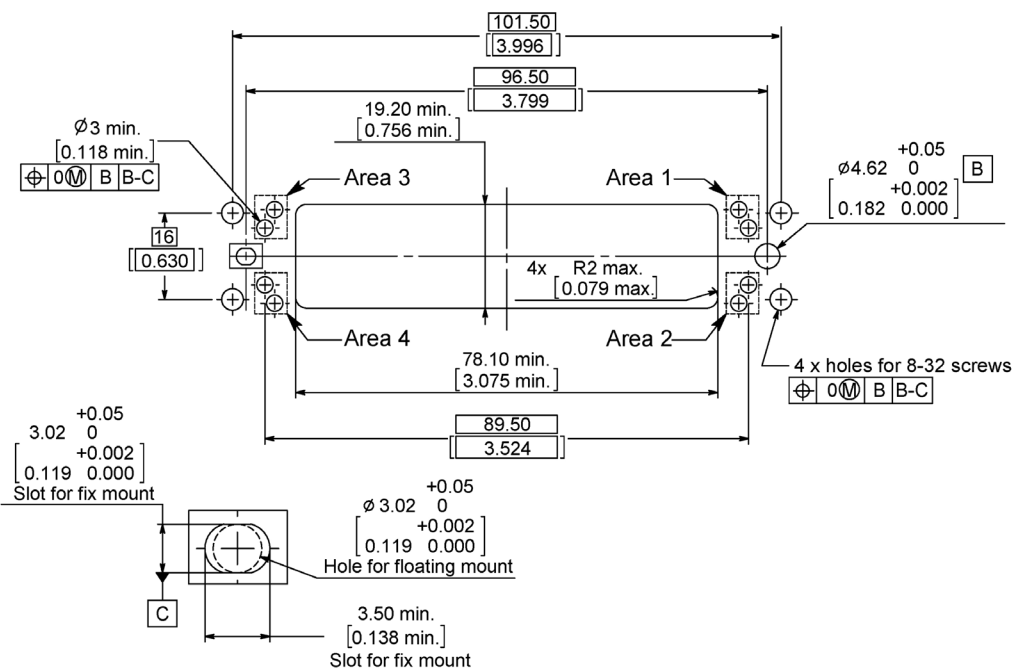

NOTE:

(1) The panel cut-out is shown from the rear of the panel

c-enx™ B3 SHELL DIMENSIONS & PANEL CUT-OUTS

RECEPTACLE

Floating Mount

Fixed Mount

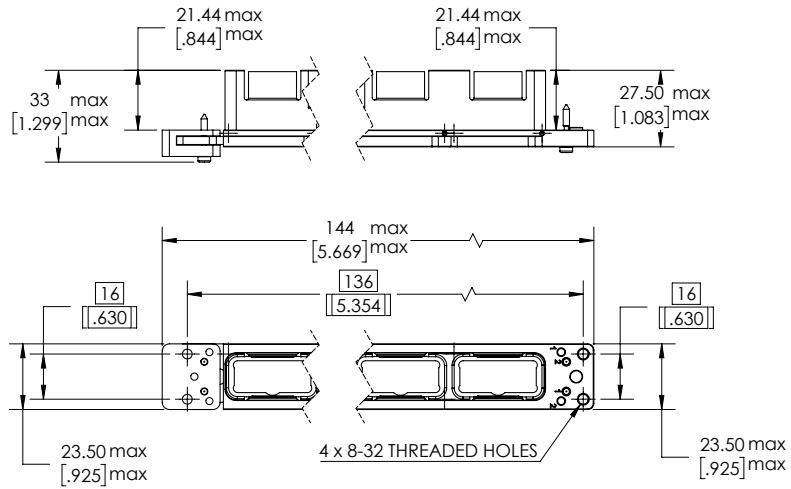

PLUG

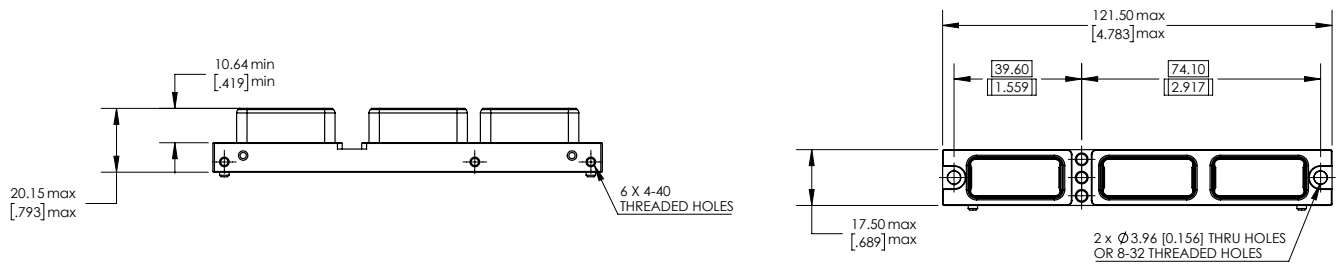

PANEL CUT OUT (1)

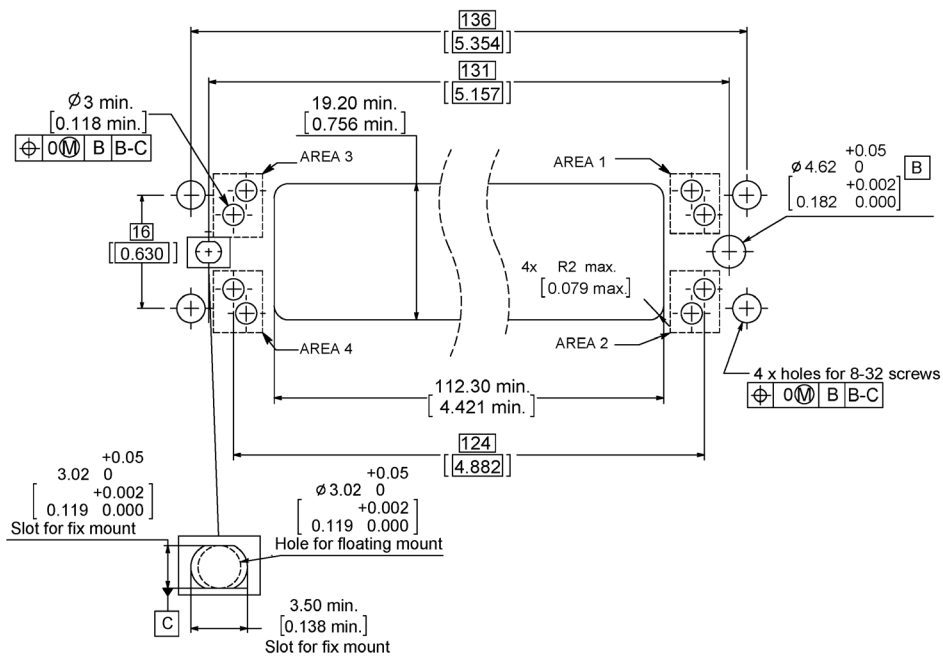

NOTE:

① The panel cut-out is shown from the rear to the panel

c-enx™ B4 SHELL DIMENSIONS & PANEL CUT-OUTS

RECEPTACLE

Fixed Mount

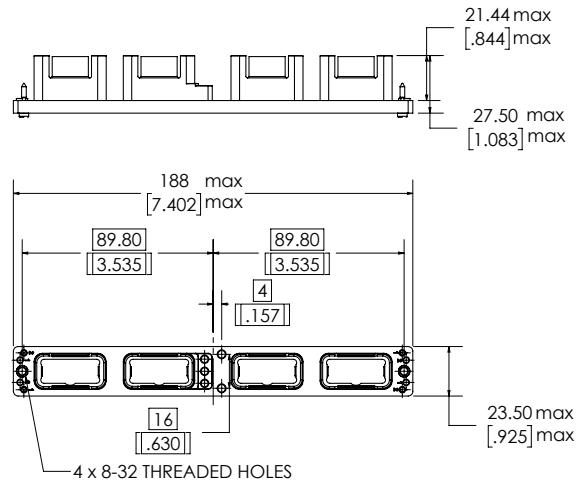

PLUG

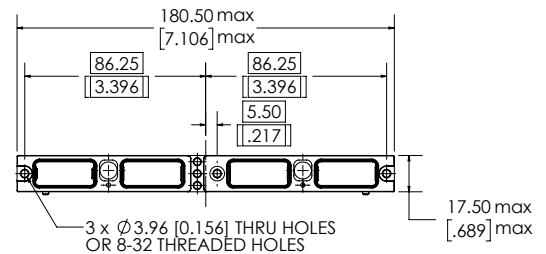
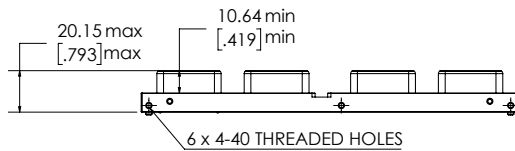

PANEL CUT OUT (1)

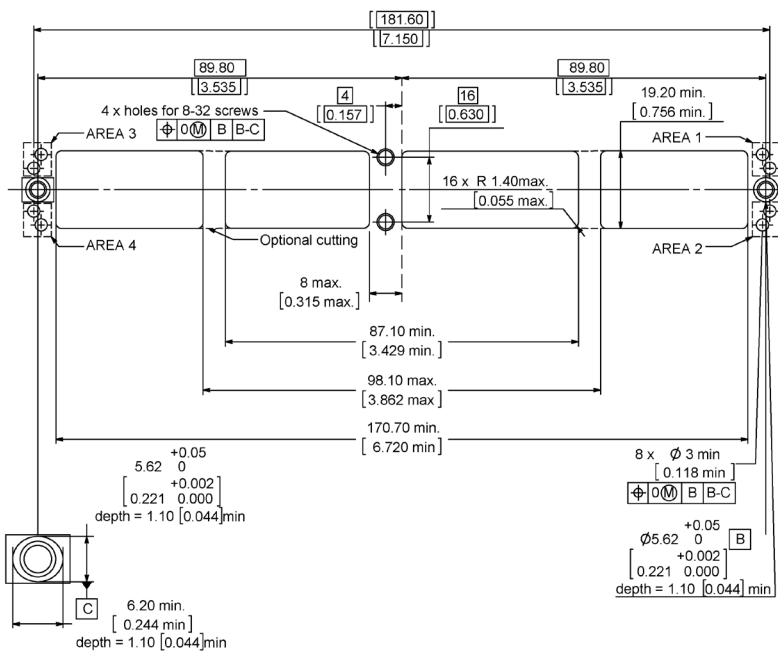

NOTE:

(1) The panel cut-out is shown from the rear of the panel

c-enx™ B PANEL CUT-OUT CODING

Coding is available on shells to correlate with the correct panel cut-out for instances where multiple c-enx® B connectors are used with the same equipment.

Four areas are coded on the panel cut out (1 - 4 shown below). One of the two holes should be drilled or each area (n°1 or hole n°2). A coding pin on the shell corresponds to each hole on the panel cut-out.

| Panel Cut-out Coding | Panel Hole Number to Drill in Area 1 | Panel Hole Number to Drill in Area 2 | Panel Hole Number to Drill in Area 3 | Panel Hole number to Drill in Area 4 |
|----------------------|---|--------------------------------------|--------------------------------------|--------------------------------------|
| A | Connector delivered with coding device uninstalled | | | |
| B | 1 | 1 | 1 | 1 |
| C | 1 | 1 | 1 | 2 |
| D | 1 | 1 | 2 | 1 |
| E | 1 | 1 | 2 | 2 |
| F | 1 | 2 | 1 | 1 |
| G | 1 | 2 | 1 | 2 |
| H | 1 | 2 | 2 | 1 |
| J | 1 | 2 | 2 | 2 |
| K | 2 | 1 | 1 | 1 |
| L | 2 | 1 | 1 | 2 |
| M | 2 | 1 | 2 | 1 |
| N | 2 | 1 | 2 | 2 |
| P | 2 | 2 | 1 | 1 |
| R | 2 | 2 | 1 | 2 |
| S | 2 | 2 | 2 | 1 |
| T | 2 | 2 | 2 | 2 |
| Z | Connector delivered without coding pin ⁽¹⁾ | | | |

Coding Pins are for Receptacle Only

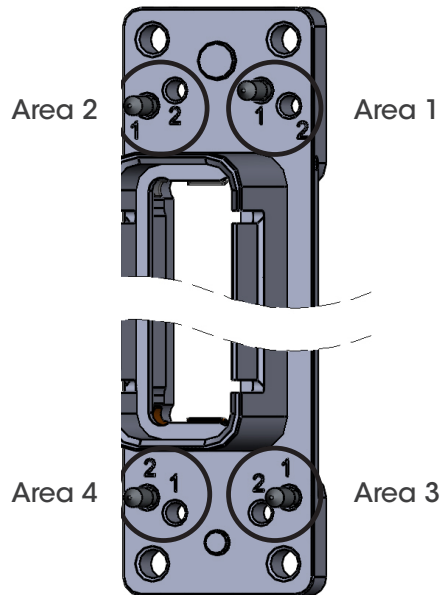

NOTE:
(1) Z panel cut out coding is only available with fix mounting

Coding C: 1 1 1 2

Hole No 2 drilled in area 1
 Hole No 1 drilled in area 2
 Hole No 1 drilled in area 3
 Hole No 2 drilled in area 4

c-enx™ B POLARIZATION CODE

Polarization Code Definitions

Part number includes the polarization device and can be installed as shown below. There are three keys on each shell which can be in four different position.

Polarization keys can have their own position providing codification range.

Plug size 3

Polarization post

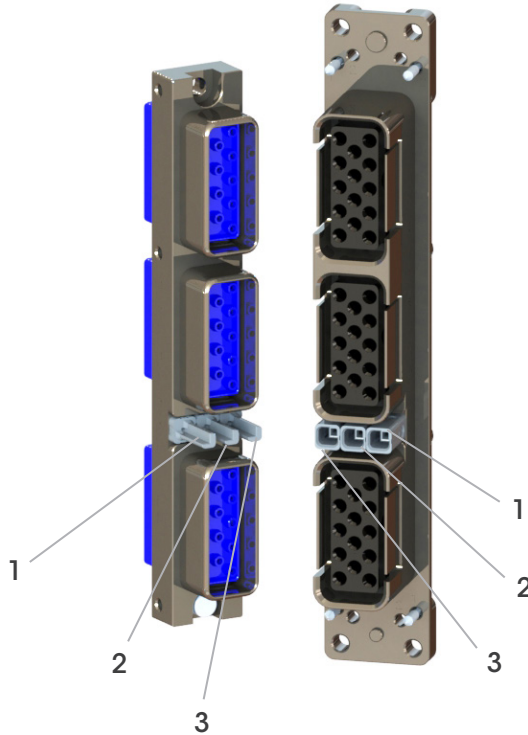

Receptacle size 3

Polarization key





Connectors are shown front side with cavity A upwards.
Read your code this way for either C-ENX B2 or C-ENX B3 or C-ENX B4.



RACK & PANEL ACCESSORIES

| | Part Number | Description | Assembly Torque |
|---|-------------|---|------------------------------------|
|  | C-617925073 | EMI backshell for receptacle only (Aluminum nickel-plated) | 0.55±0.05 Nm (4.87±0.44 in-lbs) |
|  | C-617922022 | Straight strain relief for receptacle only (composite) | 0.55±0.05 Nm (4.87±0.44 in-lbs) |
|  | C-617954002 | Dust cap for plug shell (pink color) | N/A |
| | C-617954003 | Dust cap for receptacle shell (pink color) | N/A |
| | C-617954004 | ESD dust cap plug shell (black color) | N/A |
| | C-617954005 | ESD dust cap receptacle shell (black color) | N/A |
|  | C-617980052 | Coding Pin | 0.8 Nm (7 in-lbs) |
|  | C-617980054 | Polarization post | N/A |
|  | C-617980055 | Polarization key | N/A |

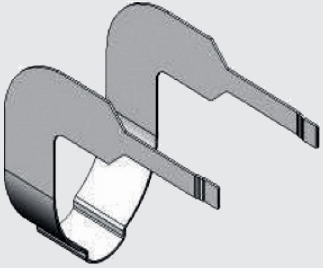
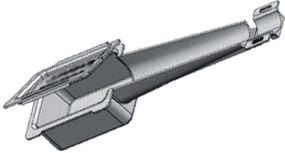
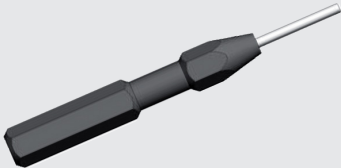
RACK & PANEL TOOLS

| | Part Number | Description | C-ENX B |
|---|--------------|--|---------|
|  | C-282521002 | Insert extraction tool | X |
|  | C-282521004 | Right angle insert extraction tool | X |
|  | C-617954020 | Plastic box to protect wired inserts during handling | X |
|  | C-F780855000 | Hexagonal key 2mm (5/64inch) Flats for sleeve holder removal | X |
|  | C-282549041 | Removal tool for metal coding keys (M81969/30-06) | X |

c-enx™ GALLEY PRODUCT OVERVIEW

Designed for the harsh galley equipment conditions, the c-enx™ B2 Galley connector includes a floating mechanism which guarantees a fully sealed connection and avoids risk of improper mating.

The c-enx™ B2 connector's modular design is ideal for ovens, microwave ovens, refrigerators, beverage makers other equipment meant for standardized galley layouts.

The extra contact density solution makes it easy to add new contacts including the #8 Twinax CAN data bus contact. Backshell accessories are also available.

Detailed view of receptacle and plug with accessories for the C-ENX B2 galley connector.

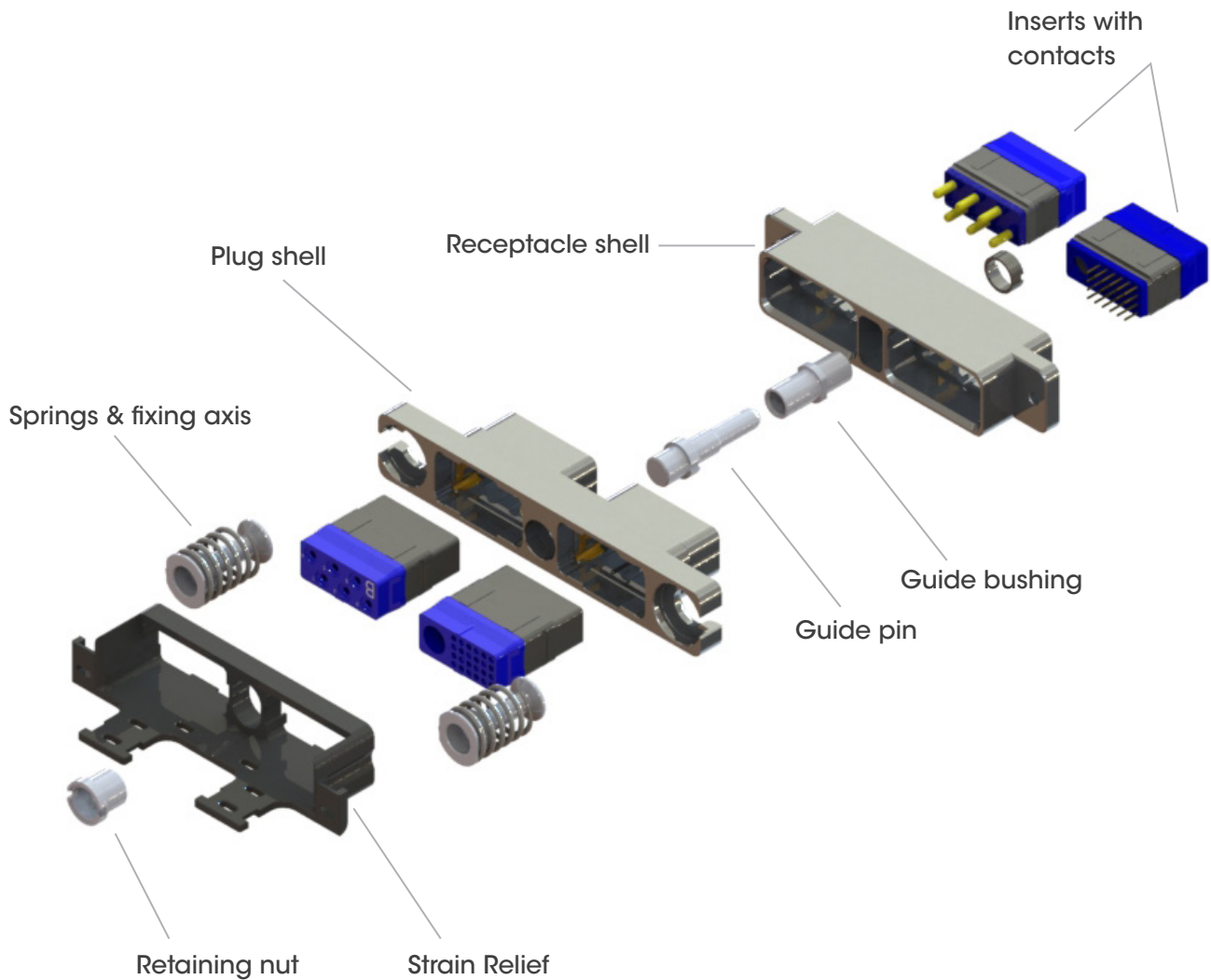

HOW TO ORDER c-enx™ GALLEY EQUIPMENT CONNECTOR

Receptacle and Plug Assembly Kit

| Part Number | Description |
|----------------------------|------------------------------|
| C-617610188 or C-617610558 | Receptacle assembled kit (*) |
| C-617610189 | Plug assembled kit (*) |

(*)Part numbers for assembly kits include: plug or receptacle shell, inserts, contacts, sealing plugs and dust caps

Each item included in the kit is indicated in the table below and can also be ordered separately.

Receptacle Kits

| C-617610188 Shell with 2 Self-locking Threaded Holes | | | C-617610558 Shell with 2 Thru Holes | | |
|---|----------------------------|------------------|--|----------------------------|------------------|
| Part Number | Description | Quantity per Kit | Part Number | Description | Quantity per Kit |
| C-617610212 | Receptacle shell | 1 | C-617610419 | Receptacle shell | 1 |
| C-ENXBE25Q1PA | Insert for cavity A | 1 | C-ENXBE25Q1PA | Insert for cavity A | 1 |
| C-ENXBE06PB | Insert for cavity B | 1 | C-ENXBE06PB | Insert for cavity B | 1 |
| C-617200 | Pin crimp contacts/Size 22 | 15 | C-617200 | Pin crimp contacts/Size 22 | 15 |
| C-617250 | Pin crimp contacts/Size 12 | 6 | C-617250 | Pin crimp contacts/Size 12 | 6 |
| C-616910 | Filler plug | 9 | C-616910 | Filler plug | 9 |
| C-617954003 | Dust cap | 2 | C-617954003 | Dust cap | 2 |

Plug Kit

C-617610189 contents

| Part Number | Description | Quantity per Kit |
|---------------|-------------------------------|------------------|
| C-617610213 | Plug shell | 1 |
| C-ENXBE25Q1SA | Insert for cavity A | 1 |
| C-ENXBE06SB | Insert for cavity B | 1 |
| C-617300 | Socket crimp contacts/Size 22 | 15 |
| C-617350 | Socket crimp contacts/Size 12 | 6 |
| C-616910 | Filler plug | 9 |
| C-617922007 | Strain relief | 1 |
| C-617954002 | Dust cap | 2 |

Can Data Bus Contact

| Part Number | Description |
|-------------|------------------------------|
| C-617165011 | Size 8 Twinax pin contact |
| C-617065011 | Size 8 Twinax socket contact |

c-enx™ GALLEY DIMENSIONS AND PANEL CUT OUT

RECEPTACLE

Front Mount

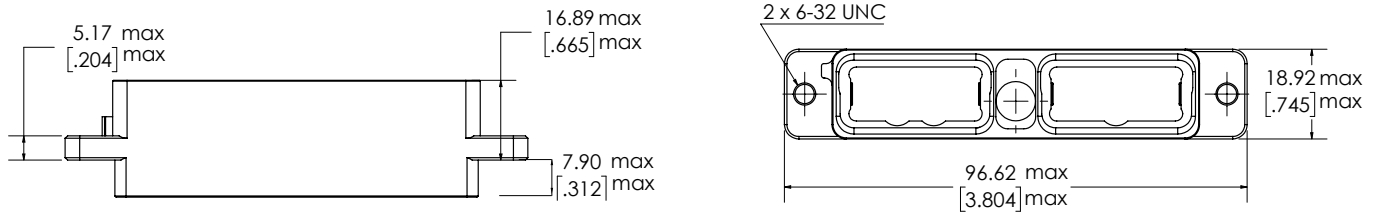

PLUG

Rear Mount

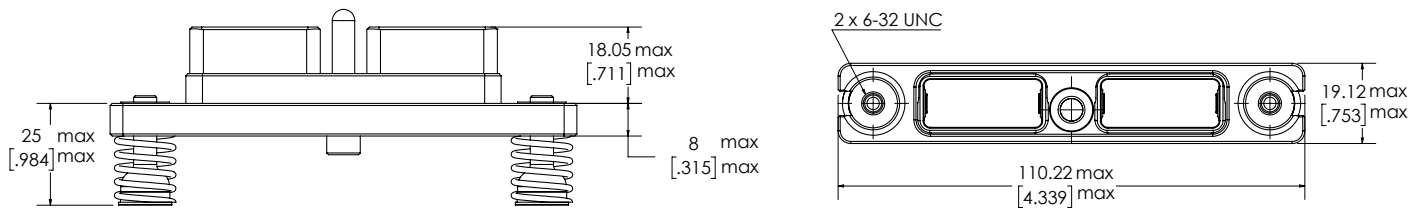

PANEL CUT OUT

Receptacle

Plug

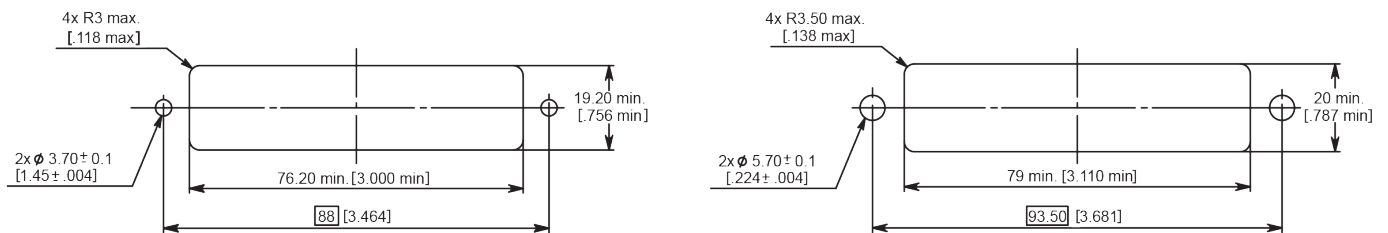

MULTI-GANG c-enx™ CONNECTORS

Cinch offers a wide range of multigang connectors for rack, panel and disconnect applications.

Features & Benefits

- Quick and easy installation
- Weight saving design
- Modular design with a wide range of inserts
- c-enx™ connector functionality with c-enx™ B2 standard plug shells and a multigang shell

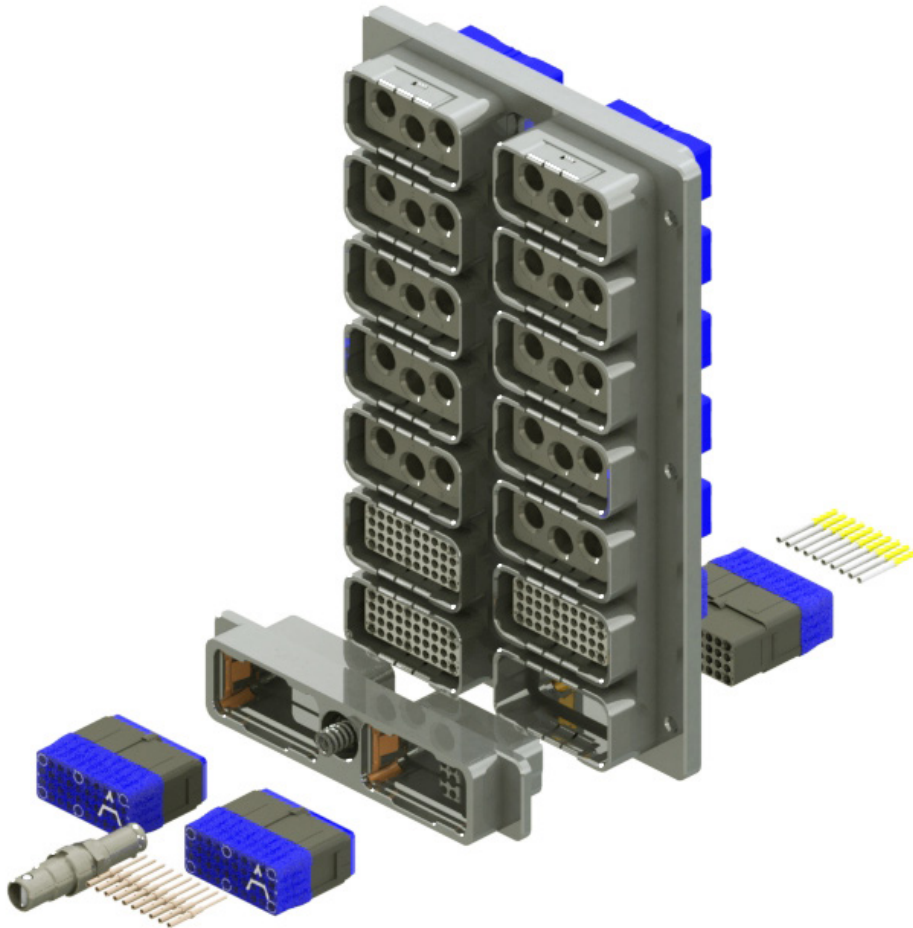

Specifications

- 4 to 20 cavities for c-enx™ B
- Available with standard c-enx® strain reliefs and backshells
- EN 4644 performance

Options

- Grounding block
- Grounding spring fingers
- Float mounting
- Spring loaded mounting