



**c-enx™**  
EN 4644 Electrical & Fiber Interconnect Solutions Catalog



[belfuse.com/cinch](http://belfuse.com/cinch)

# About Cinch Connectivity Solutions

For 100 years, Cinch Connectivity Solutions has manufactured high quality & reliable high performance connectors & cable assemblies to the Aerospace, Military/Defense, Commercial, Rugged Harsh Environments & Communication markets. Our custom solutions deliver creative, hands-on engineering whilst utilizing multiple contact technologies including fiber optic expanded beam and QPL listed products. We aim to exceed our customers' expectations & continually provide innovative solutions to the rapidly changing needs of the markets & customers we serve.

## Table of Contents

### Introduction

Disconnect Application	4
Rack and Panel Application	5

### c-enx™ Series

Technical Characteristics for Disconnect Connectors	6
Technical Characteristics for Rack & Panel Connectors	7
Technical Characteristics: Inserts & Contacts	8
Mechanical Characteristics: Inserts & Contacts	9

### Inserts

Insert Selection Table	10
How to Order C-ENX Inserts	11
C-ENX A Insert Arrangements	12
C-ENX B Insert Arrangements	12
C-ENX B Insert Arrangements	13

### Contacts

Power & Signal Crimp Contacts	14
Oversized & Reduced Crimp Barrel Contacts	15
Coaxial Crimp Contacts	16
Twinax & Triax Crimp Contacts	17
Quadrax & BMA Crimp Contacts	18
Signal PC Tail Contacts	20
Filler/Sealing Plugs & QuadraxPC Tail Contacts	21
Contacts for GBE Links	22

### Disconnect Application

c-enx™ A & c-enx™ B1 Product Overview	23
How to Order C-ENX A & C-ENX B1 Shell	24
How to Order C-ENX A & C-ENX B1 Assembly Kit	25
Contacts Termination for C-ENX B1	26
C-ENX A Shell Dimensions	27
C-ENX B1 Shell Dimensions	28
Polarization Code	29

C-ENX A & C-ENX B1 Accessories	30
C-ENX B2 Disconnect Connectors	31
c-enx™ B2 Product Overview	32
How to Order C-ENX B2 Shell	33
How to Order C-ENX B2 Assembly Kit	34
Contacts Termination for Receptacles	35
C-ENX B2 Metallic Shell Dimensions	36
C-ENX B2 Composite Shell Dimensions	37
C-ENX B2 Polarization Code	38
C-ENX B2 Polarization Code	39
C-ENX B2 Accessories	40
C-ENX B2 Spare Parts	41
Tools	42

### Rack & Panel Application

c-enx™ B1 Product Overview	43
c-enx™ B2 Product Overview	43
c-enx™ B3 Product Overview	
How to Order C-ENX B1, B2, B3 & B4 Shell	44
c-enx™ B4 Product Overview	45
How to Order C-ENX B1, B2, B3 & B4 Assembly Kits	46
Contacts Termination for C-ENX B1, B2, B3, B4 Plugs	47
C-ENX B1 Shell Dimensions & Panel Cut-Outs	48
C-ENX B2 Shell Dimensions & Panel Cut-Outs	49
C-ENX B3 Shell Dimensions & Panel Cut-Outs	50
C-ENX B4 Shell Dimensions & Panel Cut-Outs	51
C-ENX B Panel Cut-Out Coding	52
C-ENX B Polarization Code	53
Rack & Panel Accessories	54
Rack & Panel tools	55
c-enx™ Galley Product Overview	56
How to Order C-ENX Galley Equipment Connector	57
Dimensions and Panel Cut Out	58
Multi-Gang C-ENX Connectors	59

# YOU NEED A SPACE, WEIGHT & COST SAVING SOLUTION. WE HAVE ONE.

Cinch is an established provider of interconnect products. We understand and solve engineering challenges in Commercial Aerospace and Military applications.

Our c-enx™ series EN 4644 modular connectors are ideal for applications with limited space and weight restrictions. Cinch manufactures harnesses equipped with c-enx™ for Avionics, Radar, Power and Flight management applications.

## Save Time and Money with our Simple Installation

- Easy to install with our common panel cut-out
- Wire your insert in the workshop, install in the shells later
- Simple insert installation and removal from shells
- No more mis-mating with our keyed shells and inserts
- Crimp contacts which are inserted and extracted with standard mil spec tools
- Sub-assemblies are field replaceable
- Self-locking threads are vibration resistant



### Modular solution

- Shell accommodate inserts for signal, power, coax, data bus, fiber optic and high frequency BMA contacts
- Ground block option for FAA HIRF requirements
- Plug and receptacle shells accommodate pin and socket inserts installation (pin contacts are fitted in the pin insert)



### Two insert sizes, Two Materials

Shell materials include aluminum and composite material providing solutions for many applications.

### Space Saving

Slim, high density, stackable design. No need for extra room to lock and unlock connectors.



### EBOSA Available

Our c-enx™ Series is available with electrical and optical interfaces including, Cinch EBOSA™ Expanded Beam Technology. Our patented active alignment technology which aligns a standard LC ferrule to Cinch's EBOSA™ with ultra-high precision.

## How C-ENX™ stacks up against circular connectors



### C-ENX B:

- 5 shells #2 with 2\*48 Cts
- » Total Cts: 480
- » Total surface:  
 $96.90 * 91.80 = 8895.42 \text{ mm}^2$
- Gives  $18.53 \text{ mm}^2/\text{contact}$



### 38999 :

- 4 shells #23 with 100 Cts
- » Total Cts: 400
- » Total surface:  $96.00 * 96.00 = 9216 \text{ mm}^2$
- Gives  $23.04 \text{ mm}^2/\text{contact}$

# DISCONNECT APPLICATION



The Cinch c-enx™ connector series is designed for use in a PCB-cable disconnect and in cable-cable disconnect applications.

Each connector in our C-ENX A, C-ENX B1 and C-ENX B2 line has a locking system on the connector itself.

## Compact, Modular, and Easy to Use.

- Compact: Access our locking system design from the back of the shell. Space is saved and connectors can be stacked.
- Modular: Use the same tools and accessories; spare parts are reduced.
- Easy assembly: Mate the connector on panel with a standard Allen wrench tool.

Configurable components create high performance connectors (environmental, grounding blocks, shell mountings, etc). Harnesses can be developed utilizing several types of accessories including backshells.

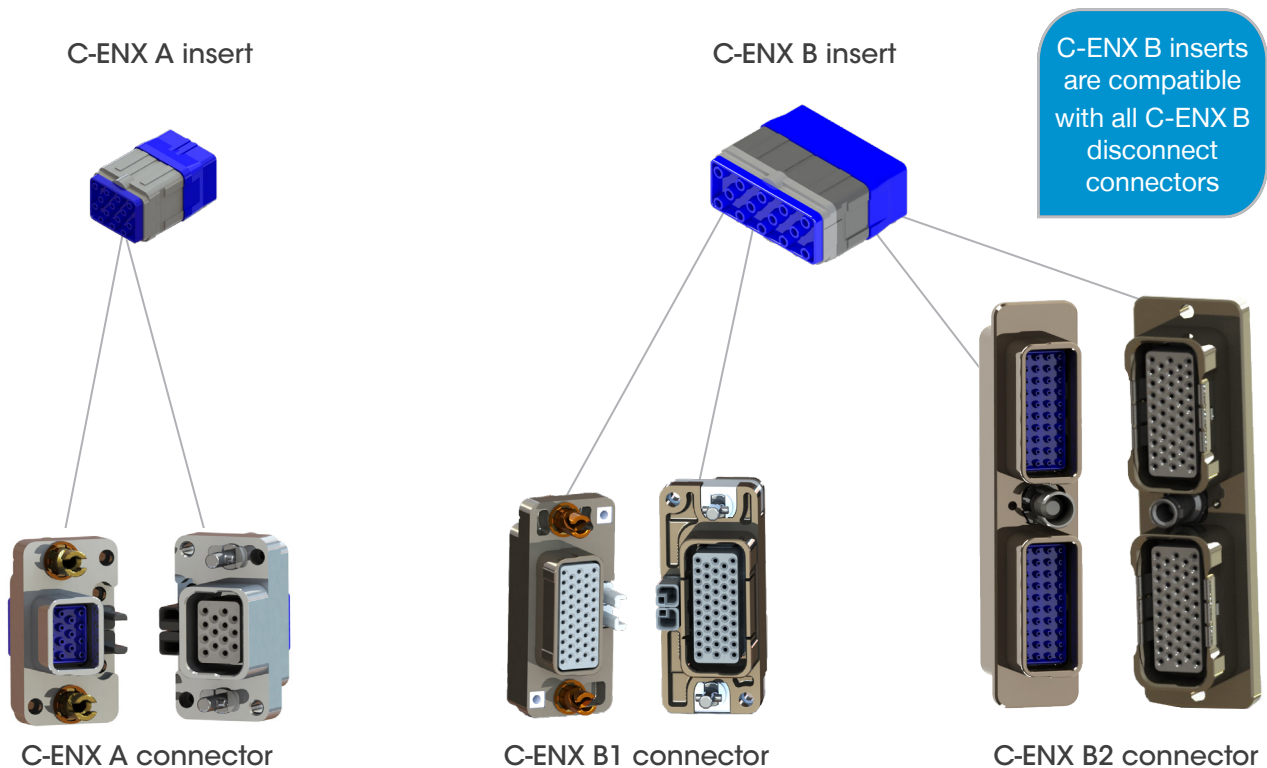

# RACK AND PANEL APPLICATION

Cinch offers rack and panel connectors accommodating new equipment design and miniaturization requirements for Line Replaceable Module (LRM) applications.

These connectors are designed for blind mate applications. The receptacle is installed on the aircraft rack while the plug connector is used in an LRM. Locking mechanisms are part of aircraft equipment interface; not the blind mate connectors.

## c-enx™: Wide range, Reliable, ARINC 600 functionality

- Offered in sizes 1 to 4 in a wide range of connectors based on the same design.
- Series uses same standard accessories, polarization and mounting style.
- Our system prevents mismatching between panel and receptacle shell, as well as between the plug receptacle shells. Electronic system mounting mistake proofing with Cinch's polarization device.
- Save space: our modular mounting c-enx® connectors are offered in several styles (fixed or float mount).
- Rack and panel receptacles feature ARINC 600 functionality.

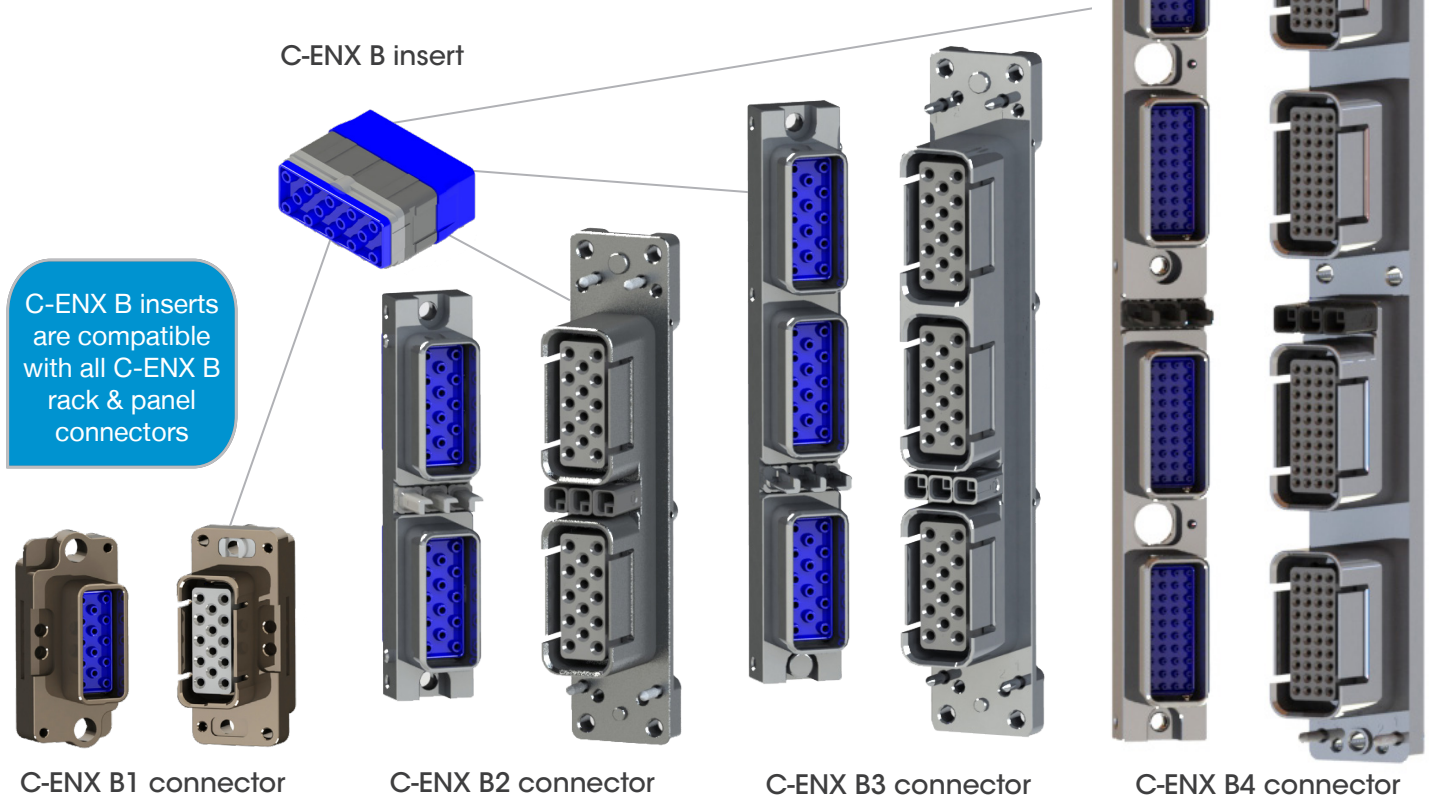
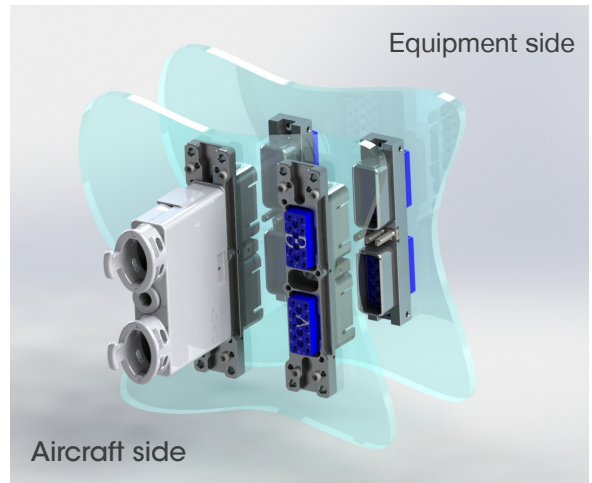

# TECHNICAL CHARACTERISTICS FOR DISCONNECT CONNECTORS

## Electrical Characteristics

EMI Shielding Effectiveness per EN 2591-213

Frequency (MHz)	Leakage Attenuation (dB)
100	65
200 & 300	63
400	62
500 & 600	60

## Other Characteristics

- **Shell to shell conductivity** < 2.5 mΩ, operating voltage: 400 Vrms or 500 Vdc at sea level, according to EN 2591-205
- **Voltage stability (ground block):** Maximum variation 4mV according to SAE AS 81714 (MIL-T-81714)
- **Lightning strike:**
  - 5kA - 1600V for C-ENX connectors in aluminum version
  - 3kA - 1600V for C-ENX connectors in composite version

## Mechanical Characteristics

Mating/unmating

Shell type	Material	Mating/Unmating
C-ENX A	Aluminum	100 cycles
C-ENX B1	Aluminum	100 cycles
C-ENX B1	Composite	100 cycles
C-ENX B2	Composite	100 cycles <sup>(1)</sup>
C-ENX B2	Aluminum	100 cycles <sup>(1)</sup>

## Shock & Vibration

Shell Type	Material	Vibration	Shock
		For 8 hrs on each of the 3 axis/ interruption <1μs EN 2591-403 EIA 364-28	3 shocks on each axis EN 2591-402 EIA 364-27
C-ENX A	Aluminum	Acceleration 27.8g (test condition 6 letter G)	Shock amplitude 50g /duration 11ms
C-ENX B1	Aluminum	Acceleration 27.8g (test condition 6 letter G)	Shock amplitude 50g /duration 11ms
C-ENX B1	Composite	Acceleration 27.8g (test condition 6 letter G)	Shock amplitude 50g /duration 11ms
C-ENX B2	Composite	Acceleration 27.8g (test condition 6 letter G)	Shock amplitude 50g /duration 11ms
C-ENX B2	Aluminum	Shock amplitude 300g /duration 3ms	Shock amplitude 300g /duration 3ms
Disconnect C-ENX with Quadrax contacts	/	Acceleration 16.9g (test condition 5 letter E)	Shock amplitude 50g /duration 11ms

### NOTE:

(1) 500 mating cycles possible when using lubricant (as per the standard Mil-spec DOD G 24508) on locking device

# TECHNICAL CHARACTERISTICS FOR RACK & PANEL CONNECTORS

## Electrical Characteristics

EMI Shielding Effectiveness per EN 2591-213

Frequency (MHz)	Leakage Attenuation (dB)
100	65
200 & 300	63
400	62
500 & 600	60

## Other Characteristics

- **Shell to shell conductivity** < 2.5 m Ω, operating voltage: 400 Vrms or 500 Vdc at sea level, according to EN 2591-205
- **Voltage stability (ground block):** Maximum variation 4mV according to SAE AS 81714 (MIL-T-81714)
- **Lightning strike:**
  - 5kA - 1600V for C-ENX connectors in Aluminum version
  - 3kA - 1600V for C-ENX connectors in composite version

## Mechanical Characteristics

Mating/unmating

Shell Type	Material	Mating/Unmating
C-ENX B1	Aluminum	500 cycles
C-ENX B2	Aluminum	500 cycles
C-ENX B3	Aluminum	500 cycles
C-ENX B4	Aluminum	500 cycles

The minimum mating forces are described in the EN 4644 standard and depends on the connector size and insert arrangement. Consult Cinch for more information.

## Shock & Vibration

Shell Type	Material	Vibration	Shock
		For 8 hrs on each of the 3 axis / interruption <1μs EN 2591-403 EIA 364-28	3 shocks on each axis EN 2591-402 EIA 364-27
C-ENX B1	Aluminum	Acceleration 16.9g (test condition 5 letter E)	Shock amplitude 50g /duration 11ms
C-ENX B2	Aluminum	Acceleration 16.9g (test condition 5 letter E)	Shock amplitude 50g /duration 11ms
C-ENX B3	Aluminum	Acceleration 16.9g (test condition 5 letter E)	Shock amplitude 50g /duration 11ms
C-ENX B4	Aluminum	Acceleration 16.9g (test condition 5 letter E)	Shock amplitude 50g /duration 11ms

# TECHNICAL CHARACTERISTICS: INSERTS & CONTACTS

## Electrical Characteristics

Electrical characteristics conform to SAE AS 39029 (MIL-C-39029 type A)

Contacts conform to EN3155-076 and EN3155-077

## Contacts

Contact Size	Wire Size	Max Current Amps
22	AWG 22	5
	AWG 24	3
	AWG 26	2
20	AWG 20	7.5
	AWG 22	5
	AWG 24	3
16	AWG 16	13
	AWG 18	10
	AWG 20	7.5
12	AWG 12	23
	AWG 14	17
	AWG 16	13
8	AWG 8	46
	AWG 10	33
5	AWG 8	80 <sup>(1)</sup>
	AWG 10	33

### NOTE:

(1) Size 5 contacts are not part of SAE AS 39029 (MIL-C-39029 type A). They are qualified by Cinch to 80 Amps.

## Ground Block Contact

	Contact with Wire Size	Max Current Amps
Contact to contact	Contact + AWG 20	7.5
Contact to mounting surface	Contact + AWG 20	7.5

## Dielectric Withstanding Voltage per EN 2591-207/EIA 364-20 with leakage current < 1mA

Level	Environmental Inserts Voltage (VRMS)	Non-environmental Voltage (VRMS)
Sea level	1500	1500
50,000 feet	800	600
70,000 feet	800	300

## Insulation Resistance per EN 2591-206/EIA 364-21

Temperature	Insulation Resistance
Ambient temperature	> 5000 MΩ
175°C (+347°F)	> 200 MΩ



# MECHANICAL CHARACTERISTICS: INSERTS & CONTACTS

## Retention Characteristics

Contact retention force tested per EN 2591-409 and EIA 364-29 for terminated connectors.

Contact Size	Retention Force	Max Displacement
Ground block	89 N (20.0 lbs)	0.30mm (.012 in)
22	53 N (11.9 lbs)	0.38mm (.015 in)
20	89 N (20.0 lbs)	0.38mm (.015 in)
16	111 N (25.0 lbs)	0.38mm (.015 in)
12	133 N (29.9 lbs)	0.38mm (.015 in)
8	156 N (35.1 lbs)	0.38mm (.015 in)
5	133 N (29.9 lbs)	0.38mm (.015 in)

- **Insert retention:** 400N (90 lbs) EN 2591-410 / EIA 364-35
- **Maximum insert displacement in the shell cavity:** 0.30mm (.012 in)

## Environmental Characteristics

### Temperature

- **Temperature range:** -65°C/+175°C (-85°F/+347°F) according to EN 2591-305 and EIA 364-32
- **Temperature range:** -65°C/+125°C (-85°F/+257°F) for C-ENX B2 composite shell and for Rack & Panel C-ENX B
- **Temperature life:** 1000 hours at maximum temperature

### Other Characteristics

- **Salt spray:** 96 hours (nickel-plated Aluminum and composite) EN 2591-307 and EIA 364-26 test condition A
- **Humidity:** 10 days with temperature variation from -10°C to +65°C EIA 364-31 Method 4, test condition B
- **Altitude immersion:** 3 cycles at 50,000 feet EN 2591-314 and EIA 364-03

# INSERT SELECTION TABLE

Indicate insert name when ordering C-ENX insert. Indicate insert code when ordering kit assembly.

Series	Insert Name	Insert Code	Contact Size & Type <sup>(1)</sup>										Total Contacts	
			22*	20*	15 or 16*	16	12*	8	8	8	5	5		
			Signal	Power	Power or Coax	Power in Fiber Optic Cavity	Power or Coax	Power	Quadrax or Twinax	BMA	Coax or Triax	Power		
C-ENX A	00	0												0
	1C1	A										1		1
	1P1	B											1	1
	04	C			2		2							4
	09	D		3	6									9
	14	E		14										14
	14M	F	8	3	3									14
	17	G	12	5										17
	20	H	20											20
C-ENX B	00	0												0
	C3	A										3		3
	P3	B											3	3
	3Q3	C								3				3
	06	D					6							6
	10Q2	E		8						2				10
	12F6	F				6								12
	F12C	G												12
	13C1	H		6	4		2					1		13
	13P1	J		6	4		2						1	13
	14	K			14									14
	17	L		14			3							17
	20C1	M		19								1		20
	20P1	N		19									1	20
	22	P		16	6									22
	22V	Q		16	6									22
	25P1	R	24						1					25
	25Q1	S	24							1				25
	28	T	22		6									28
	30	U		30										30
	34	W	18	16										34
40	X	40											40	
48	Y	48											48	
3T3	Z									3			3	

**NOTE:**

(1) Only contacts marked with an asterisk (\*) are included with C-ENX inserts  
 All other contacts must be ordered separately (coax, twinax, quadrax and fiber optic contacts)

# HOW TO ORDER c-enx™ INSERTS

## Environmental Insert



## Insert Keying Detail



Crimp contacts only can be delivered with insert.

<b>Series Prefix</b>	C-ENX	B	E	40	P	B	S
<b>Cinch C-ENX™ Connector <sup>(1)</sup></b>							
<b>Insert size</b> A: Insert for C-ENX A B: Insert for C-ENX B1, C-ENX B2, C-ENX B3 or C-ENX B4							
<b>Class<sup>(2)</sup></b> E: Environmental N: Non-environmental (no rear grommet, no interfacial seal) H: Non-environmental with a rear grommet, available for pin insert only (recommended for crimp contacts) T: Non-environmental with an interfacial seal, available for pin insert only (recommended for PC tail contacts)							
<b>Insert name</b> Refer to table on page 10 for insert arrangements							
<b>Insert type</b> P: Pin S: Socket							
<b>Insert keying<sup>(3)</sup></b> A: Keying A B: Keying B							
<b>Contact</b> Without code: insert delivered without contacts <b>S:</b> Signal and power contacts are delivered with inserts but are uninstalled (refer to page 10). Inserts 00, 1C1, 1P1, C3, P3, 3Q3, 12F6, F12C and 3T3 are not available in S contact version							

### NOTES:

(1) Inserts are designed for rear release & rear removable contacts

(2) Pin and socket inserts can be installed in either plug or receptacle shell F6, F12C and 12F6 are only available in E class, Insert 00 is only available in N class

(3) For C-ENX A, C-ENX B1, C-ENX B3 and C-ENX B4 shells, use only insert keyed A (for C-ENX B2 shells, use one insert keyed A and one insert keyed B)

# c-enx™ A INSERT ARRANGEMENTS <sup>(3)</sup>



**Insert Name 00**  
**Insert Code 0**  
Blank insert<sup>(1)</sup>



**Insert Name 1C1**  
**Insert Code A**  
1 x size 5 coax contact



**Insert Name 1P1**  
**Insert Code B**  
1 x size 5 power contact



**Insert Name 04**  
**Insert Code C**  
2 x size 15 or 16 contacts  
2 x size 12 contacts



**Insert Name 09**  
**Insert Code D**  
3 x size 20 contacts  
6 x size 15 or 16 contacts



**Insert Name 14**  
**Insert Code E**  
14 x size 20 contacts



**Insert Name 14M**  
**Insert Code F**  
8 x size 22 contacts  
3 x size 20 contacts  
3 x size 15 or 16 contacts



**Insert Name 17**  
**Insert Code G**  
12 x size 22 contacts  
5 x size 20 contacts



**Insert Name 20**  
**Insert Code H**  
20 x size 22 contacts

# c-enx™ B INSERT ARRANGEMENTS <sup>(3)</sup>

Full size inserts arrangements per EN 4644



**Insert Name 00**  
**Insert Code 0**  
Blank insert<sup>(2)</sup>



**Insert Name C3**  
**Insert Code A**  
3x size 5 coax contacts



**Insert Name P3**  
**Insert Code B**  
3 x size 5 power contacts



**Insert Name 3Q3**  
**Insert Code C**  
3 x size 8 quadrax contacts



**Insert Name 06**  
**Insert Code D**  
6 x size 12 medium power contacts

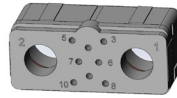

**Insert Name 10Q2**  
**Insert Code E**  
8 x size 20 contacts  
2 x size 8 quadrax contacts



**Insert Name 13C1**  
**Insert Code H**  
6 x size 20 contacts  
4 x size 15 or 16 contacts  
2 x size 12 contacts  
1 x size 5 coax contact



**Insert Name 13P1**  
**Insert Code J**  
6 x size 20 contacts  
4 x size 15 or 16 contacts  
2 x size 12 contacts  
1 x size 5 power contact

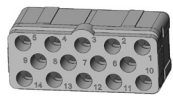

**Insert Name 14**  
**Insert Code K**  
14 x size 15 or 16 contacts

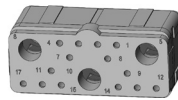

**Insert Name 17**  
**Insert Code L**  
14 x size 20 contacts  
3 x size 12 contacts

NOTE: (1) P/N for blank insert is C-ENXAN00 (2) P/N for blank insert is C-ENXBN00 (3) Non-environmental inserts shown

# c-enx™ B INSERT ARRANGEMENTS

Full size inserts arrangements per EN 4644

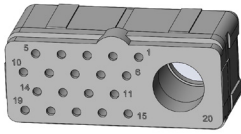

**Insert Name 20C1**  
**Insert Code M**  
 19 x size 20 contacts  
 1 x size 5 coax contact

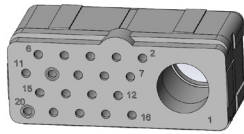

**Insert Name 20P1**  
**Insert Code N**  
 19 x size 20 contacts  
 1 x size 5 power contact

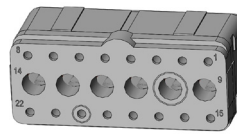

**Insert Name 22**  
**Insert Code P**  
 16 x size 20 contacts  
 6 x size 15 or 16 contacts

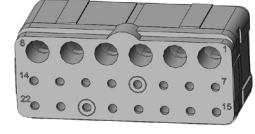

**Insert Name 22V**  
**Insert Code Q**  
 16 x size 20 contacts  
 6 x size 16 contacts

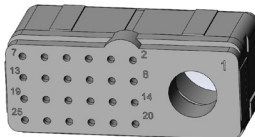

**Insert Name 25P1**  
**Insert Code R**  
 24 x size 22 contacts  
 1 x size 8 power contact

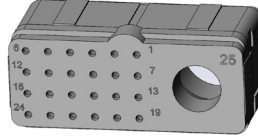

**Insert Name 25Q1**  
**Insert Code S**  
 24 x size 22 contacts  
 1 x size 8 quadrax contact

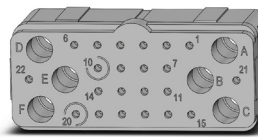

**Insert Name 28**  
**Insert Code T**  
 22 x size 22 contacts  
 6 x size 15 or 16 contacts

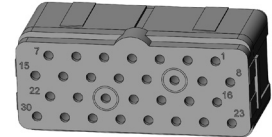

**Insert Name 30**  
**Insert Code U**  
 30 x size 20 contacts

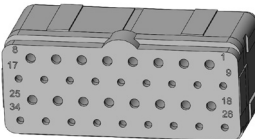

**Insert Name 34**  
**Insert Code W**  
 18 x size 22 contacts  
 16 x size 20 contacts

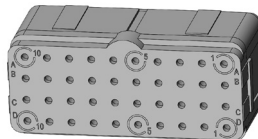

**Insert Name 40**  
**Insert Code X**  
 40 x size 22 contacts

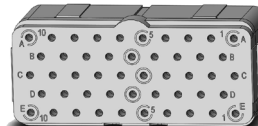

**Insert Name 48**  
**Insert Code Y**  
 48 x size 22 contacts

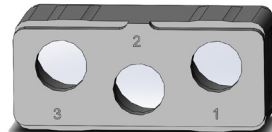

**Insert Name 3T3 (1)**  
**Insert Code Z**  
 3 x size 8 BMA pin contacts

**NOTE:**

(1) 3T3 pin insert only is available. It is mateable with 3Q3 socket insert

# POWER & SIGNAL CRIMP CONTACTS

c-enx™ series is available in a wide range of contacts compliant with EN3155 and SAE AS 39029. Gold plating also available.

## Contacts available in cable and PCB termination

- Power and signal contacts
- Coax, twinax and triax high frequency contacts
- Quadrx contact ethernet links

### Benefits

- Significant cost reduction
- Decreased gold rate fluctuation dependence
- Contact crimping and soldering process does not change

### Specifications

- Contact design identical to full plated version
- 1.27µm (50µin) gold plated contact interface
- Crimp version does not require crimping process changes
- Use of selective plated contacts on PC tail version does not impact PCB design
- Contact Cinch for product qualification information

Contact Size	Wire Size (AWG)	Type	Part Number Full Plated	Part Number Selectively Plated	Crimping Tool	Positioner	Selector	Ins / ext Tool	Type of Tool	
22	22	Pin	C-617200	C-617200100	C-282281 M22520/2-01	C-282970 M22520/2-23	4	C-282522 (M81969/14-01)	Plastic	
	24						3			
	26	Socket	C-617300	C-617300100			3			
20	20	Pin	C-617221	C-617221100	C-282281 M22520/2-01	C-282971 M22520/2-08	7	C-282522001 (M81969/39-01))	Plastic	
	22						6			
	24	Socket	C-617320	C-617320100			5			
16	16	Pin	C-617240	C-617240100	C-282291 M22520/1-01	C-282972 M22520/1-02	6	C-282522001 (M81969/39-01)	Plastic	
		Socket	18	C-617340			C-617340100			5
			20							4
	Ground block	20	Pin	C-617221050	N/A	C-282281 M225520/2-01	C-282581015 M22520/2-11	7	C-282886	Metal
			Socket	N/A	N/A	N/A	N/A	N/A	N/A	N/A
	for optical/ electrical insert	16	Pin	C-617235003(1)	N/A	C-282291 M22520/1-01	C-282581013	6	C-282515 (M81969/14-03)	Plastic
		18						5		
20		4								
12	12	Pin	C-617250	C-617250100	C-282291 M22520/1-01	C-282972 M22520/1-02	8	C-282549004 (M81969/14-04)	Plastic	
	14	Socket	C-617350	C-617350100			7			
							16			6
8	8	Pin	C-617291002 <sup>(2&amp;3)</sup>	N/A	C-R282600000 M22520/23-01 + Die set C-R282650000 M22520/23-02	C-282588	N/A	C-282549001	Metal	
	10	Socket	C-617391002 <sup>(2&amp;3)</sup>	N/A			N/A			
5	8	Pin	C-617280 <sup>(2&amp;4)</sup>	N/A	C-282557020	C-282557021	N/A	C-282946 (M81969/28-01)	Metal	
	10	Socket	C-617390 <sup>(2&amp;4)</sup>	N/A			N/A			
	12	Pin	C-617260001 <sup>(2&amp;4)</sup>	N/A	C-282613	C-282586003	6	C-282946 (M81969/28-01)	Metal	
	16	Socket	C-617370001 <sup>(2&amp;4)</sup>	N/A			6			

### NOTES:

- (1) Electrical contacts for optical inserts are always pin contacts (hermaphrodite)
- (2) In order to make these contacts environmental, it is necessary to add a sealing boot. Please contact us for additional information
- (3) These power contacts can be used in power inserts only (25P1)
- (4) These power contacts can be used in power inserts only (P3, 13P1 and 20P1)

# OVERSIZED & REDUCED CRIMP BARREL CONTACTS

Contact Size	Wire Size (AWG)	Type	Part Number Fully Plated	Crimping Tool	Positioner	Selector	Ins / ext Tool	Type of Tool	
22	reduced crimp barrel	28	Pin	C-617201 (1)	C-282281 M22520/2-01	C-282970 M22520/2-23	5	C-282522 (M81969/14-01)	Plastic
		30	Socket	C-617301(1)			4		
	oversize crimp barrel	20	Pin	C-617200200	C-282281 M22520/2-01	C-282970 M22520/2-23	5	C-282522 (M81969/14-01)	Plastic
		22	Socket	C-617300200			4		Plastic
		24					3		Plastic
20	reduced crimp barrel	22	Pin	C-617224001 (1)	C-282281 M22520/2-01	C-282970 M22520/2-23	4	C-282522001 (M81969/39-01)	Plastic
		24	Socket	C-617224001 (1)			4		
		26					3		
	oversize crimp barrel	18	Pin	C-617221200	C-282281 M22520/2-01	C-282970 M22520/2-23	5	C-282522001 (M81969/39-01)	Plastic
		20	Socket	C-617320200			5		
		22					4		
16	reduced crimp barrel	20	Pin	C-617241 (1)	C-282291 M22520/1-01	C-282972 M22520/1-02	5	C-282515 (M81969/14-03)	Plastic
		22	Socket	C-617341 (1)			5		
		24					4		
	reduced crimp barrel for optical electrical insert	20	Pin	C-617235002 (2)	C-282291 M22520/1-01	C-282581013	5	C-282515 (M81969/14-03)	Plastic
		22					5		
		24					4		
	oversize crimp barrel	14	Pin	C-617240200	C-282291 M22520/1-01	C-282972 M22520/1-02	6	C-282515 (M81969/14-03)	Plastic
		16	Socket	C-617340200			5		
		18					5		

## NOTES:

(1) When smaller wire sizes are used on contacts with reduced crimp barrel, the wire will not provide sealing to the grommet.

If sealing is required, please contact Cinch.

(2) Electrical contacts for optical inserts are always pin contacts (hermaphrodite)

# COAXIAL CRIMP CONTACTS

Contact Size	Cable Type	Type	Environmental Part Number	Non-environmental Part Number	Ins/ext Tool	Type of Tool
15-16	RG174-RG179 RG316	Pin	C-617130	C-617130	C-282512	Metal
		Socket	C-617030	C-617030		
	RG178	Pin	C-617131	C-617131		
		Socket	C-617031	C-617031		
	GORE/AXON P812817 FILECA F1703-134 FILOTEX SP132868	Pin	C-617132	C-617132		
		Socket	C-617032	C-617032		
	RG178 DT	Pin	C-617133	C-617133		
		Socket	C-617033	C-617033		
	UT 047	Pin	C-617135	C-617135		
		Socket	C-617035	C-617035		
12	UT 085-RG405	Pin	C-617160	C-617160	C-282549004 (M81969/14-04)	Plastic
		Socket	C-617060	C-617060		
5	RG58-RG141	Pin	C-617101001	C-617101	C-282946 (M81969/28-01)	Metal
		Socket	C-617001001	C-617001		
	RG142 - RG400	Pin	C-617102001	C-617102		
		Socket	C-617002001	C-617002		
	RG174-RG316 RG188	Pin	C-617103001	C-617103		
		Socket	C-617003001	C-617003		
	RG178-RG196	Pin	C-617104001	C-617104		
		Socket	C-617004001	C-617004		
	RG180	Pin	C-617105001	C-617105		
		Socket	C-617005001	C-617005		



# TWINAX & TRIAX CRIMP CONTACTS

Contact Size	Cable Type	Type	Environmental Part Number	Non-environmental Part Number	Ins/ext Tool	Type of Tool
12 Triax	ECS0700	Pin	C-617190010	C-617190010	C-282549004 (M81969/14-04)	Plastic
		Socket	C-617090010	C-617090010	C-282549004 (M81969/14-04)	Plastic
	M17/176-00002	Pin	C-617190012	C-617190012	C-282549004 (M81969/14-04)	Plastic
		Socket	C-617090012	C-617090012	C-282549004 (M81969/14-04)	Plastic
8 Triax	TENSOLITE 24473/03159X-2	Pin	C-617165021	C-617165020	C-282549001	Metal
		Socket	C-617065021	C-617065020	C-282549001	Metal
	WHITMOR W26751575	Pin	C-617165	C-617165001	C-282549001	Metal
		Socket	C-617065	C-617065001	C-282549001	Metal
8 Twinax	ABS0386WF24 & TYCO 1726A1424A	Pin	C-617165011	C-620165010	C-282549001	Metal
		Socket	C-617065011	C-620065010	C-282549001	Metal
5 Triax	M17/176-0002	Pin	C-617150001	C-617150	C-282946 (M81969/28-01)	Metal
		Socket	C-617050001	C-617050	C-282946 (M81969/28-01)	Metal
	PAN6421	Pin	C-617152001	C-617152	C-282946 (M81969/28-01)	Metal
		Socket	C-617052001	C-617052	C-282946 (M81969/28-01)	Metal



# QUADRAX & BMA CRIMP CONTACTS

## Quadrax Contacts



Contact Size	Cable Type	Type	Environmental Part Number	Non-environmental Part Number	Extraction Tool in Metal
8	Ethernet cable ABS0972 & ABS1503	Pin	C-617175011	C-617175012	C-282549001
		Socket	C-617075011	C-620075010	
	TENSOLITE NF24Q100	Pin	C-617175051	C-617175052	
		Socket	C-617075051	C-620075050	
	Tensolite NF26Q100 JSF Y18	Pin	C-617175053	C-617175054	
		Socket	C-617075053	C-620075021	

## BMA Contacts



Contact Size	Cable Type	Connector Type	Environmental Part Number	Non-environmental Part Number	Frequency Range	Max VSWR	Insertion Loss
8	SHF5 - SHF5M <sup>(1)</sup>	Pin <sup>(2)</sup>	C-617171011	C-617171010	DC-18.0 GHz	1.35	0.13 dB at max frequency (18.0 GHz)
	RG142	Pin <sup>(2)</sup>	C-617171021	C-617171020	DC-12.4 GHz	1.35	0.11 dB at max frequency (12.4 GHz)
	SHF2 4M <sup>(1)</sup> /UT 0.085 Harbour SS405 Times Tflex405	Pin <sup>(2)</sup>	C-617171031	C-617171030	DC-18.0 GHz	1.35	0.13 dB at max frequency (18.0 GHz)
	SHF5 - SHF5M <sup>(1)</sup>	Socket	C-617071011	C-617071010	DC-18.0 GHz	1.35	0.13 dB at max frequency (18.0 GHz)
	RG142	Socket	C-617071021	C-617071020	DC-12.4 GHz	1.35	0.11 dB at max frequency (12.4 GHz)
	SHF3 <sup>(1)</sup>	Socket	C-617071041	C-617071040	DC-18.0 GHz	1.35	0.13 dB at max frequency (18.0 GHz)

Extraction tool **282549001** is used for size 8 BMA contacts

Environmental BMA contacts are all provided with sealing boots

### NOTES:

(1) The BMA contacts which can accommodate SHF cables requires a termination by Cinch

(2) BMA can only be installed in modified C-ENX B Quadrax insert such as 3T3P Ex: C-ENX B E3T3PA

## Mechanical and Environmental Characteristics

	Standard	Performances
Thermal cycling	SAE AS 13441 method 1003.1	-55°C/+125°C (cable dependent)
Temperature endurance	TIA/EIA 455-4	1000 h @ 125°C (cable dependent)
Vibration	TIA/EIA 455-11	27 Grms
Shock	TIA/EIA 455-14	50 G, 11 ms
Durability	TIA/EIA 364-09	500 cycles (1)
Maintenance	SAE AS 13441 method 2002.1	10 cycles
Cable retention		68 N
1.8 mm diameter	SAE AS 13441 method 2009.1	7 N
900 µm diameter		
Humidity	TIA EIA 455-5	10 cycles / 24 h 90% RH -25°C / +65°C

### NOTES:

(1) Mating cycles are dependent on connector series  
Cinch can support you with your cable and harness assemblies  
Please contact your Cinch sales representative

# SIGNAL PC TAIL CONTACTS

## Selection table for straight PC tail contacts

Contact Termination	Contact Type	Size 22	Size 20	Size 16	Size 12	Size 8	Size 5
RA	Pin	C-617205510	C-617222514	C-617242510	C-617259505	C-617291501	C-617289506
	Socket	C-617305500	C-617322505	C-617342510	C-617359505	C-617391501	C-617389506
YA	Pin	C-617205010	C-617222014	C-617242010	C-617259005	C-617291001	C-617289006
	Socket	C-617305	C-617322005	C-617342010	C-617359005	C-617391001	C-617389006
ZA	Pin	C-617205710	C-617222714	C-617242710	C-617259705	C-617291701	C-617289706
	Socket	C-617305700	C-617322705	C-617342710	C-617359705	C-617391701	C-617389706
RB	Pin	C-617205501	C-617222512	C-617242508	C-617259506	C-617291503	C-617289504
	Socket	C-617305501	C-617322506	C-617342511	C-617359506	C-617391503	C-617389504
YB	Pin	C-617205001	C-617222012	C-617242008	C-617259006	C-617291003	C-617289004
	Socket	C-617305001	C-617322006	C-617342011	C-617359006	C-617391003	C-617389004
ZB	Pin	C-617205701	C-617222712	C-617242708	C-617259706	C-617291703	C-617289704
	Socket	C-617305701	C-617322706	C-617342711	C-617359706	C-617391703	C-617389704
RC	Pin	C-617205515	C-617222513	C-617242517	C-617259503	C-617291504	C-617289503
	Socket	C-617305508	C-617322507	C-617342513	C-617359503	C-617391504	C-617389503
YC	Pin	C-617205015	C-617222013	C-617242017	C-617259003	C-617291004	C-617289003
	Socket	C-617305008	C-617322007	C-617342013	C-617359003	C-617391004	C-617389003
ZC	Pin	C-617205715	C-617222713	C-617242717	C-617259703	C-617291704	C-617289703
	Socket	C-617305708	C-617322707	C-617342713	C-617359703	C-617391704	C-617389703
RD	Pin	C-617205509	C-617222510	C-617242509	C-617259507	C-617291505	C-617289507
	Socket	C-617305502	C-617322509	C-617342515	C-617359507	C-617391505	C-617389507
YD	Pin	C-617205009	C-617222010	C-617242009	C-617259007	C-617291005	C-617289007
	Socket	C-617305002	C-617322009	C-617342015	C-617359007	C-617391005	C-617389007
ZD	Pin	C-617205709	C-617222710	C-617242709	C-617259707	C-617291705	C-617289707
	Socket	C-617305702	C-617322709	C-617342715	C-617359707	C-617391705	C-617389707
Ins/ext. tool		C-282522 M81969/14-01	C-282522001 M81969/39-01	C-282515 M81969/14-03	C-282549004 M81969/14-04	C-282549001 M81969/28-03	C-282946 M81969/28-01

# FILLER/SEALING PLUGS & QUADRAX SIZE 8 PC TAIL CONTACTS

## Filler Plugs & Sealing Plugs

Sealing plugs are dedicated to environmental inserts and filler plugs are dedicated to non-environmental inserts.

Contact Size	Filler Plug	Sealing Plug
Size 22	C-620920	C-616910
Size 20	C-610941	C-616911
Size 16	C-620922	C-616912
Size 12	C-620923	C-616913
Size 8	Socket	C-619950
Size 8	Pin	C-619953
Size 5	Socket	C-617931
Size 5	Pin	C-617930

## Selection table for straight PC tail contacts

Contact Termination	Contact Type	Part Number Size 8
RA	Pin	C-617177512
	Socket	C-617077512
YA	Pin	C-617177012
	Socket	C-617077012
ZA	Pin	C-617177712
	Socket	C-617077712
RB	Pin	C-617177501
	Socket	C-617077502
YB	Pin	C-617177001
	Socket	C-617077002
ZB	Pin	C-617177701
	Socket	C-617077702
RC	Pin	C-617177508
	Socket	C-617077508
YC	Pin	C-617177008
	Socket	C-617077008
ZC	Pin	C-617177708
	Socket	C-617077708
RD	Pin	C-617177513
	Socket	C-617077513
YD	Pin	C-617177013
	Socket	C-617077013
ZD	Pin	C-617177713
	Socket	C-617077713
Extraction tool		C-282549001



# CONTACTS FOR GBE LINKS

Cinch's gigabit ethernet solutions deliver peak performance for applications requiring high speed transfers of digital, audio and video signals.

## Quadrax Solution

- Available with all C-ENX B connectors
- One gigabit link requires two quadrax contacts
- Quadrax 3Q3 or 10Q2 inserts available
- Speeds up to 2 Gbit/sec

## High Density Solution

- Available with all C-ENX B connectors
- One gigabit link requires four twisted pairs and eight #22 contacts
- 40 and 25Q1 inserts available
- Ensure ground continuity with additional size 22 contacts
- EMI backshell (recommended by Cinch)
- Speeds up to 1 Gbit/sec
- Short strip dimensions and easy maintenance availability are combined to get minimum impedance disturbance.

Contact Cinch customer service for additional information.

Detailed view of inserts including contacts for gigabit ethernet link.



# c-enx™ A & c-enx™ B1 PRODUCT OVERVIEW

Detailed view of receptacle and plug with accessories for the C-ENX A connector.

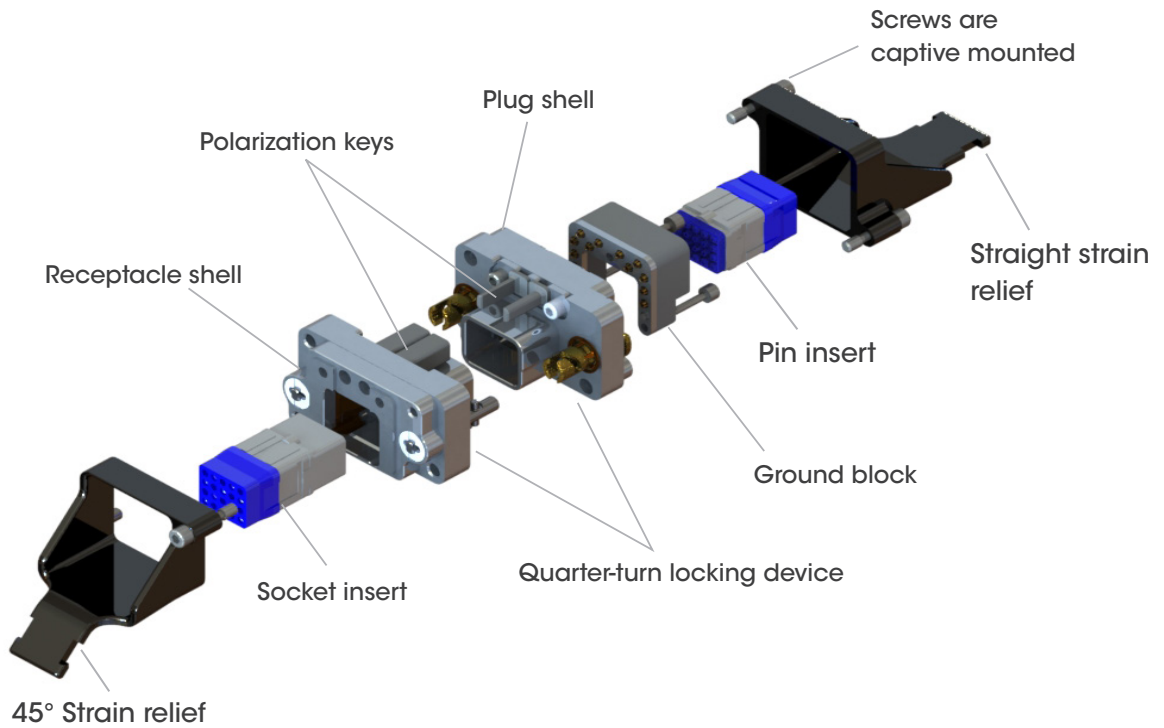

Detailed view of receptacle and plug with accessories for the C-ENX B1 connector.

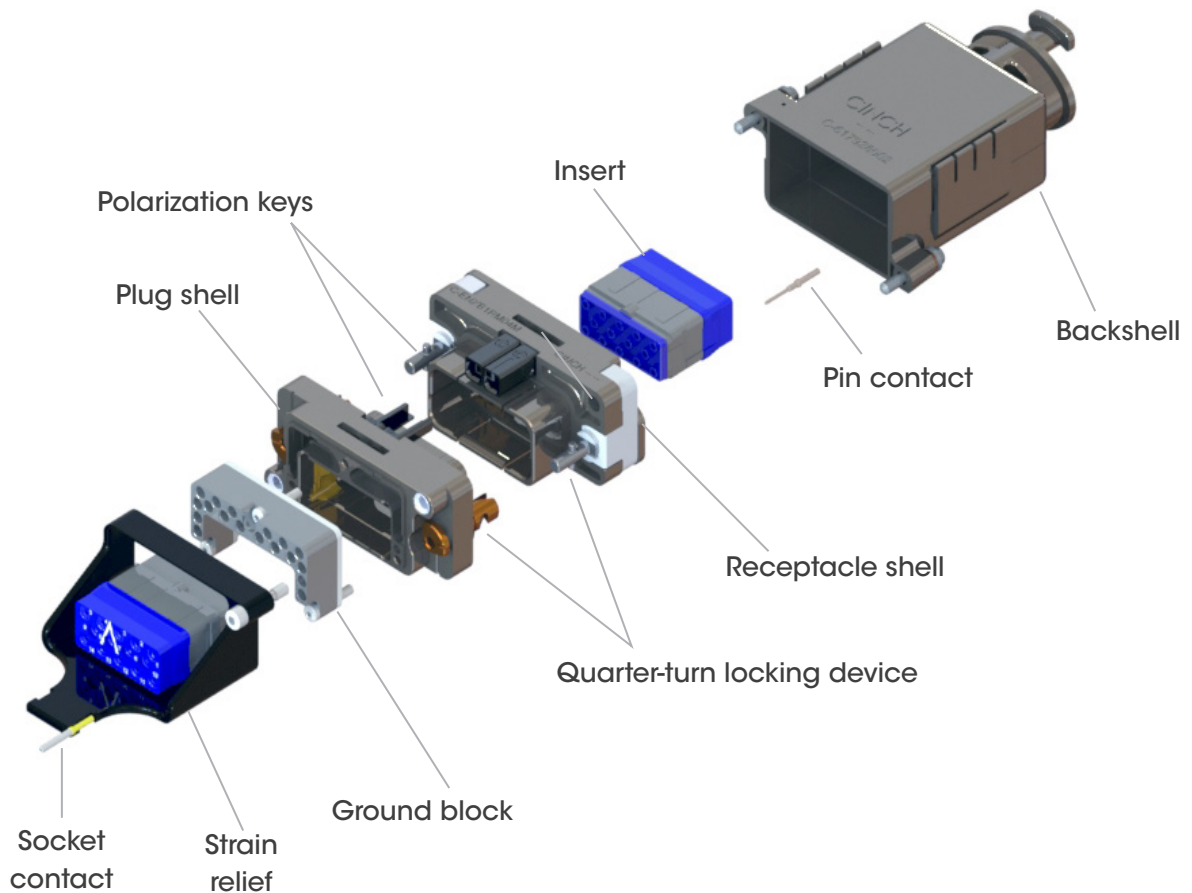

# HOW TO ORDER c-enx™ A & c-enx™ B1 SHELL

Series Prefix	C-ENX	B1	P	B	0	4	M
<b>Cinch C-ENX™ Connector</b>							
<b>Shell size</b> A1: Single small cavity shell B1: Single large cavity shell							
<b>Shell style</b> P: Plug R: Receptacle W: Plug with ground block Z: Receptacle with ground block and ground spring fingers							
<b>Shell mounting option <sup>(1)</sup></b> B: Plug without mounting holes M: Receptacle with 2 mounting holes 6-32 UNC for rear panel <sup>(2)</sup>							
<b>Locking device</b> 0: Quarter-turn fastener							
<b>Polarization code <sup>(3)</sup></b> 4: Shell delivered with polarizing hardware unassembled 5: Shell delivered with no polarizing hardware							
<b>Shell plating</b> M: Nickel-plated composite for C-ENX B1 K: Nickel-plated Aluminum for C-ENX B1 (mateable with version M composite shell) N: Nickel-plated Aluminum for C-ENX A							

## NOTES:

- (1) Recommended locking torque: 1.6Nm (14.16 in-lbs) for metallic shell and 1.1Nm (9.73 in-lbs) max for composite shell
- (2) Self-locking mounting holes are designed for rear panel mounting
- (3) Please see page 29 on how to use the polarization device





# HOW TO ORDER c-enx™ A & c-enx™ B1 ASSEMBLY KIT

Shell Selection Part	C-ENX	B1	R	4	M	E	M	YA
<b>Cinch C-ENX™ Connector</b>								
<b>Shell size</b>								
A1: Single small cavity shell								
B1: Single large cavity shell								
<b>Shell style</b>								
P: Plug								
R: Receptacle								
W: Plug with ground block								
Z: Receptacle with ground block and ground fingers								
<b>Polarization code</b>								
4: Shell delivered with polarizing hardware unassembled								
5: Shell delivered with no polarizing hardware								
<b>Shell plating</b>								
M: Nickel-plated composite for C-ENX B1								
K: Nickel-plated Aluminum for C-ENX B1 (mateable with version M composite shell)								
N: Nickel-plated Aluminum for C-ENX A								
<b>Insert Selection Part</b>								
<b>Insert class</b>								
E: Environmental								
N: Non-environmental (no rear grommet, no interfacial seal)								
H: Non-environmental insert with a rear grommet, available for pin insert only (recommended for crimp contact)								
T: Non-environmental insert with an interfacial seal, available for pin insert only (recommended for PC tail contact)								
<b>Insert code</b>								
Refer to page 10 to select insert code								
<b>Contacts termination</b>								
XS: Socket insert without contacts								
XP: Pin insert without contacts								
SS: Socket insert with crimp contacts								
SP: Pin insert with crimp contacts								
] These contacts are delivered uninstalled								
YA: Gold PC tail contacts length A								
ZA: Tin-lead PC tail contacts length A								
RA: Pure tin (RoHS) PC tail contacts length A								
] Refer to page 26 to select PC tail contacts for receptacle								

Delivery includes fully assembled kit with insert mounted into shell. Contacts included only if specified in your order.

## Tips to help you in your selection

- Pin or socket inserts may be used in C-ENX A & C-ENX B1 plug or receptacles.
- Crimp contacts available for delivery in a kit, see page 10.
- When PC tail is selected, all cavities are populated (including signal, power and quadrax). Size 5 coax cavities are not populated.
- PC tail contacts are available as pin straight PC tail contacts in receptacles only.

# CONTACTS TERMINATION FOR c-enx™ B1

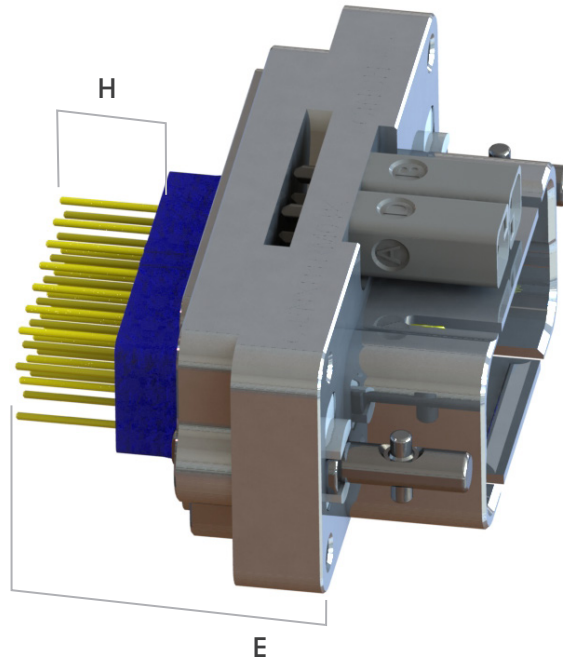

## c-enx™ B1 Receptacles (Aluminum and composite shell version)

Straight PC Tail contact termination				
Min Length E mm (inch)	Min Length H mm (inch)	Gold	Tin-lead	Pure Tin (RoHS)
16.20 (0.637) <sup>(1)</sup>	/	YA	ZA	RA
19.40 (0.763) <sup>(1)</sup>	/	YB	ZB	RB
21.25 (0.836) <sup>(1)</sup>	/	YC	ZC	RC
25.20 (0.992)	5.40 (0.212)	YD	ZD	RD

**NOTE:**

(1) These PC tail lengths are not compatible with C-ENX BE and C-ENX BH inserts

# c-enx™ A SHELL DIMENSIONS

## WITHOUT GROUND BLOCK

### Receptacle

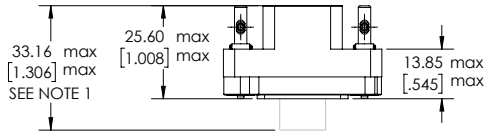

PANEL MOUNTING HOLES 2 x 6-32 UNC

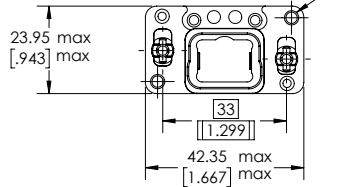

### Plug

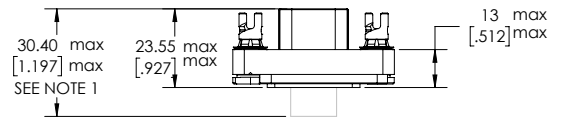

BACKSHELL MOUNTING HOLES

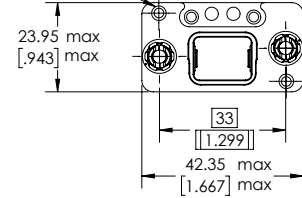

## WITH GROUND BLOCK

### Receptacle

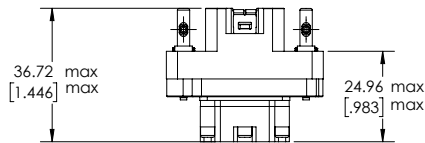

PANEL MOUNTING HOLES 2 x 6-32 UNC

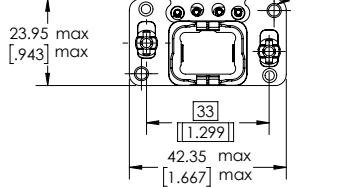

### Plug

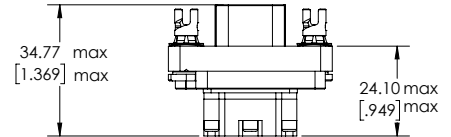

BACKSHELL MOUNTING HOLES

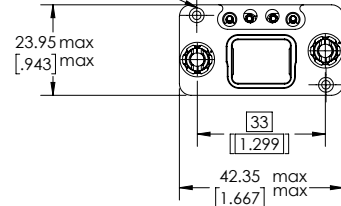

## SINGLE PANEL CUT OUT (2)

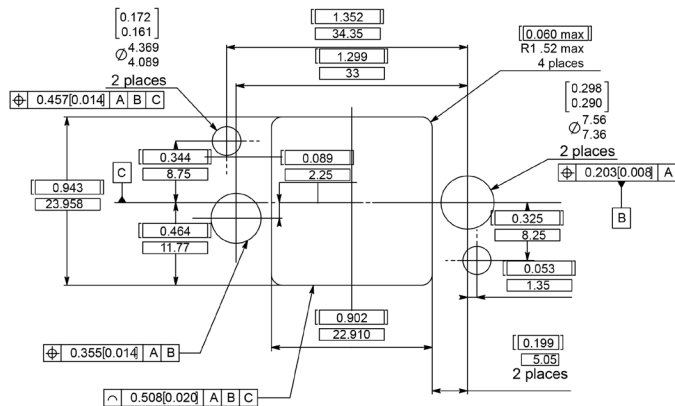

## MULTIPLE PANEL CUT OUT (2)

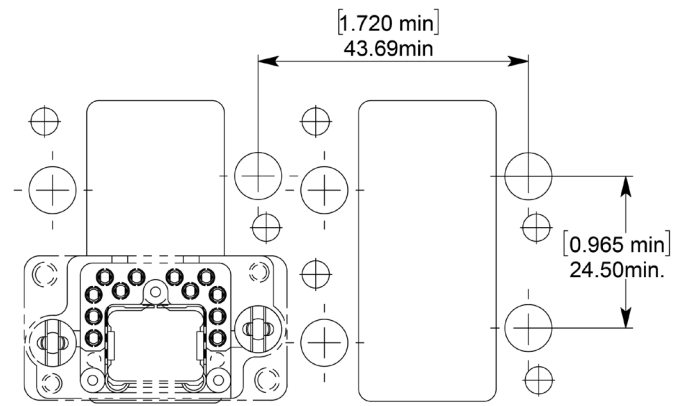

### NOTES:

- (1) Maximum dimension for insert with grommets; for inserts without grommets maximum dimensions will be for receptacle 25.55mm (1.006in) and for the plug 23.52mm (0.926in) (2) Rear mounting panel view with key post oriented to the upper side

# c-enx™ B1 SHELL DIMENSIONS

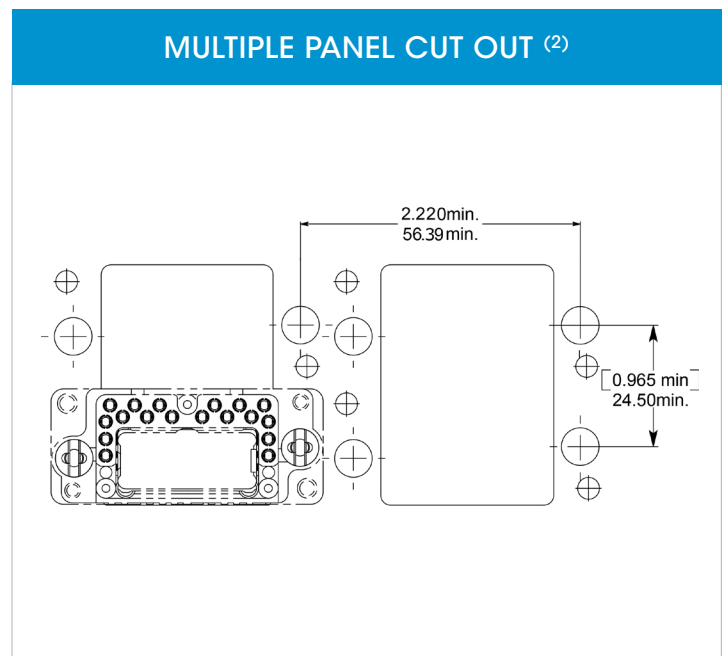
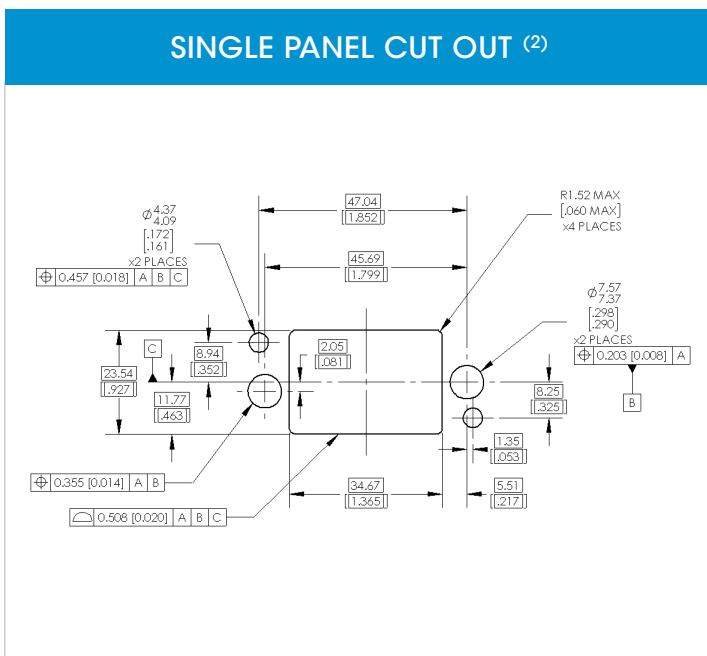
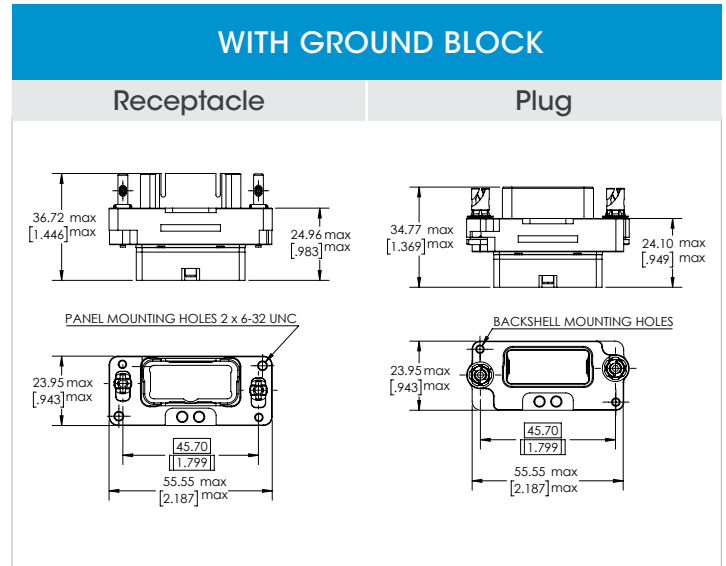
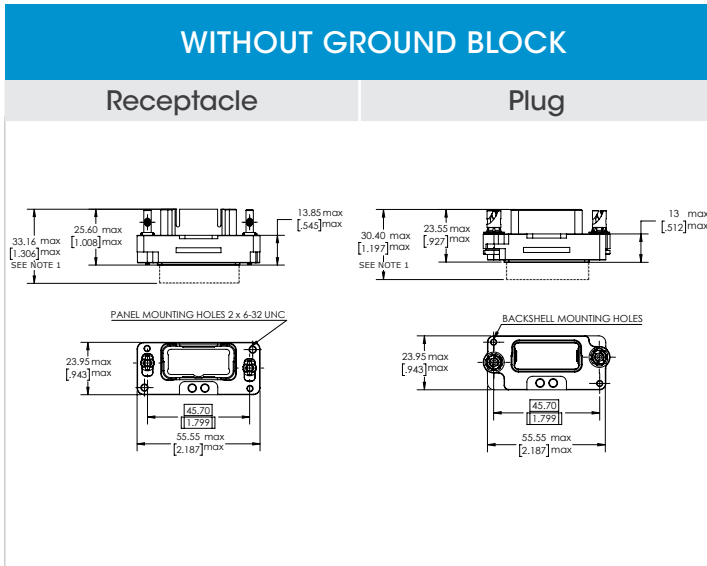

### NOTES:

- (1) Maximum dimension for insert with grommets.  
For inserts without grommets: Insert is flush to the shell.  
Maximum dimension for the receptacle is 25.60 mm (1.006 in) and for the plug is 23.55 mm (0.926 in)
- For inserts with optical contacts: the maximum dimension for the receptacle is 38.70 mm (1.524 in) and the plug is 36.00 mm (1.418 in)
- (2) Rear mounting side view with key post oriented to the upper side

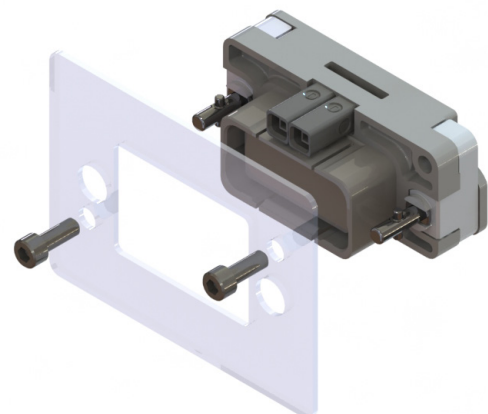

# POLARIZATION CODE

## Easy Reading of Polarization Code













Caution: Read the polarization code from left to right, the same way the part number marking can be read on the connector

	Plug	Receptacle
C-ENX A		
C-ENX B1		
Coding device	 View A & B    View C & D	 View A & D    View C & B





16 possible codings:																
Key position 1	A	A	A	A	B	B	B	B	C	C	C	C	D	D	D	D
Key position 2	A	B	C	D	A	B	C	D	A	B	C	D	A	B	C	D

# c-enx™ A & c-enx™ B1 ACCESSORIES

## Spare Parts & Dust Caps

	Part number		Description	Assembly Tool	Assembly Torque
	C-ENX A	C-ENX B1			
	C-617980032	-	Polarization kit for plug connector	C-282666002	0.8 Nm (7 In-lbs)
	C-617980033	-	Polarization kit for receptacle connector	C-282666002	0.8 Nm (7 In-lbs)
	-	C-617980030	Polarization post	N/A	N/A
	-	C-617980031	Polarization key	N/A	N/A
	C-617954006	C-617954008	Dust cap for plug shell (pink color)	N/A	N/A
	C-617954007	C-617954009	Dust cap for receptacle shell (pink color)	N/A	N/A
	C-617954044	C-617954034	ESD dust cap for plug shell (black color)	N/A	N/A
	C-617954045	C-617954028	ESD dust cap for receptacle shell (black color)	N/A	N/A
	C-617929033	-	Sealing inserts for fly away applications: mateable with pin insert	N/A	N/A
	-	C-617929023	Sealing inserts for fly away applications: mateable with pin insert	N/A	N/A
	C-617929032	-	Sealing inserts for fly away applications: mateable with socket insert	N/A	N/A
	-	C-617929022	Sealing inserts for fly away applications: mateable with socket insert	N/A	N/A

## Strain Relief and EMI Backshells

	Part number		Description	Assembly Tool	Assembly Torque
	C-ENX A	C-ENX B1			
	C-617921030	C-617921029	Straight strain relief (composite)	C-282666002	0.8 Nm (7 In-lbs)
	C-617921032	C-617921031	45° strain relief (composite)		
	-	C-617921035	Strain relief for fiber optic (anodized Aluminum)		
	-	C-617924016	Straight EMI backshell (Nickel-plated Aluminum)		
	-	C-617928002	Straight EMI backshell (Nickel-plated composite)		

**NOTE:** Contact Cinch for mounting instructions.

# c-enx™ B2 DISCONNECT CONNECTORS

## More for less

As industry demands high density and weight saving, connectors continue to grow in size. Cinch c-enx® B2 disconnect connectors are used in aerospace applications the world over. Cinch's engineering expertise designs and delivers innovative, effective and dependable solutions.

## Weight Saving Offerings

Cinch offers cable to cable and PCB to cable connections available when design calls for lighter weight application

- C-ENX B2 class M (Nickel plated composite)

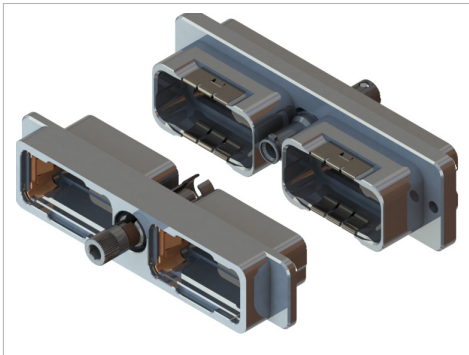

### C-ENX B2 class N

Performances

- T° range -65°C / +175°C

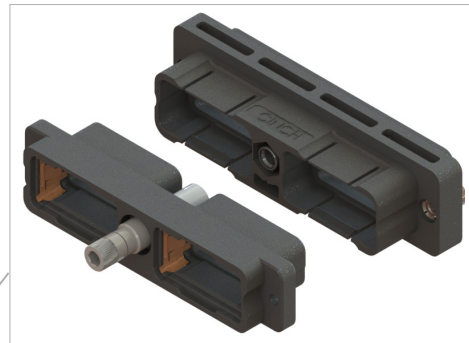

### C-ENX B2 class M

Performances

- Weight saving compared to class N C-ENX B2 : -15%

- T° range: -65°C / +125°C

# c-enx™ B2 PRODUCT OVERVIEW

C-ENX B2 disconnect connector receptacle and plug with accessories.

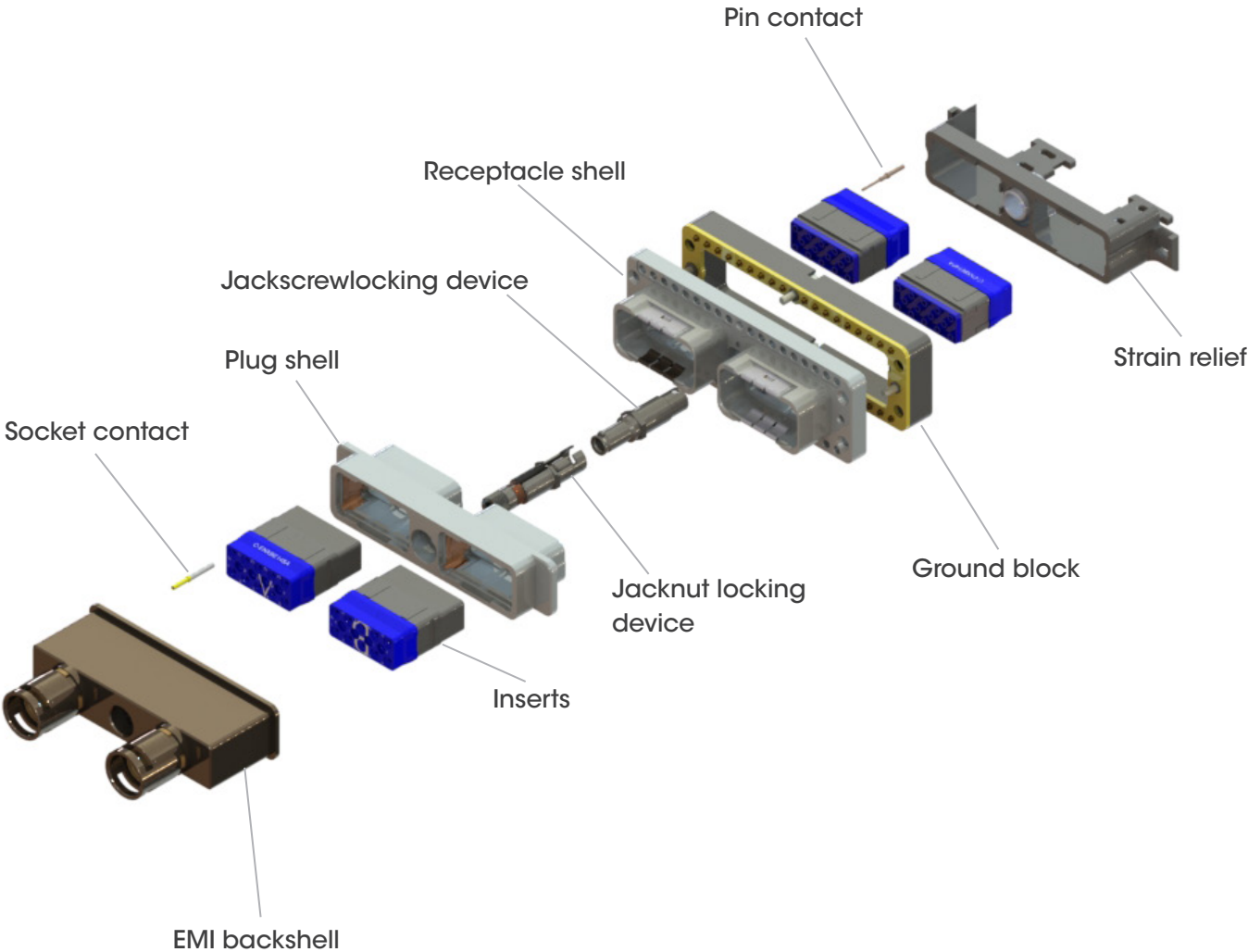



# HOW TO ORDER c-enx™ B2 SHELL

<b>Shell Selection Part</b>	C-ENX	B2	H	L	2	2	N
<b>Cinch C-ENX™ Connector</b>							
<b>Shell size</b> B2: Two cavity shell							
<b>Shell style</b> For option compatibility, see the table below L: Receptacle with flange and ground fingers H: Receptacle with ground fingers Z: Receptacle with ground block and ground fingers R: Receptacle without ground fingers P: Plug W: Plug with ground block							
<b>Shell Mounting</b> A: Panel rear mounted connector with 4 x 6-32 mounting holes B: No mounting holes D: Connector with 2 x Ø3.10 mm thru holes F: Panel rear mounted connector with 2 x 6-32 mounting holes L: Panel rear mounted connector with 2 x 4-40 mounting holes							
<b>Locking &amp; polarization device <sup>(1)</sup></b> 1: Jackscrew 2: Jacknut 3: Without locking device 4: Pin centering guide for plug shell for LRU (Line Replaceable Unit) application only (2) 5: Socket centering guide for receptacle shell for LRU (Line Replaceable Unit) application only (2)							
<b>Polarization code <sup>(3)</sup></b> 2: Polarizing device A to F delivered unassembled 3: Polarizing device N to Z delivered unassembled							
<b>Shell plating</b> N: Nickel-plated Aluminum M: Nickel-plated composite							

## Available Shell Mounting

	Shell style	A (4 x 6-32 UNC)	B (no holes)	D (2 x Ø3.10mm)	F (2 x 6-32 UNC)	L (2 x 4-40 UNC)
Class N (Aluminum)	L			√	√	√
	H		√	√	√	√
	Z	√	√			
	R	√				
	P		√	√		√
	W	√	√			
Class M (composite)	L			√		√
	P		√	√		√

### NOTES:

(1) Jackscrew/Jacknut can be mounted on either plug or receptacle shell. However, the standard options are:

- Jackscrew for plug shells
- Jacknut for receptacle shells

(2) Pin/Socket centering guides can be mounted on either plug or receptacle shells. However, the standard options are:

- Pin centering guide for plug shells
- Socket centering guide for receptacle shells

(3) Please see page 39 for how to use the polarization coding

# HOW TO ORDER c-enx™ B2 ASSEMBLY KIT

Shell Selection Part	C-ENX	B2	H	B	2	N	N	BC	ZB
<b>Cinch C-ENX™ Connector</b>									
<b>Shell size</b> B2: Two cavity shell									
<b>Shell style</b> For option compatibility, see table on page 1-36 L: Receptacle with flange and ground fingers H: Receptacle with ground fingers Z: Receptacle with ground block and ground fingers R: Receptacle without ground fingers P: Plug W: Plug with ground block									
<b>Shell mounting</b> A: Rear panel mounted connector with 4x 6-32 mounting holes B: No mounting holes D: Connector with 2 x Ø3.10 mm thru holes F: Rear panel mounted connector with 2 x 6-32 mounting holes L: Rear panel mounted connector with 2 x 4-40 mounting holes									
<b>Polarization</b> 1: Jackscrew polarizing device A to F 2: Jacknut polarizing device A to F 3: Without locking device 4: Pin centering guide for plug shell for LRU application only, polarizing device A to F 5: Socket centering guide for receptacle shell for LRU application only, polarizing device A to F 6: Jackscrew polarizing device N to Z 7: Jacknut polarizing device N to Z 8: Pin centering guide for plug shell for LRU application only, polarizing device N to Z 9: Socket centering guide for receptacle shell for LRU application only, polarizing device N to Z									
<b>Shell plating</b> N: Nickel-plated Aluminum M: Nickel-plated composite									
<b>Insert Selection Part</b>									
<b>Insert class</b> E: Environmental N: Non-environmental H: Non-environmental insert with a rear grommet, available for pin insert only (recommended for crimp contact) T: Non-environmental insert with interfacial seal, available for pin insert only (recommended for PC tail contact)									
<b>Insert code</b> Refer to page 10 to select code insert									
<b>Contacts termination</b> XS: Socket insert without contacts XP: Pin insert without contacts SS: Socket insert with crimp contacts SP: Pin insert with crimp contacts YA: Gold PC tail contacts length A ZA: Tin-lead PC tail contacts length A RA: Pure tin (RoHS) PC tail contacts length A									
			] These contacts are delivered uninstalled						
			] Refer to page 35 to select PC tail contacts for receptacle						

Delivery includes fully assembled kit with insert mounted into shell. Contacts included only if specified in your order. Place insert codes in the order you want them assembled. Locking and polarizing devices are delivered uninstalled.

## Tips to help you in your selection

- Pin or socket inserts may be used in C-ENX B2 plug or receptacle.
- Crimp contacts available for delivery in a kit, see page 10.
- When PC tail is selected, all cavities are populated (including signal, power and quadrax).  
Size 5 coax cavities are not populated.
- PC tail contacts are available as pin straight PC tail contacts in receptacles only.

All connector inserts will use the same insert class and contact termination.

# CONTACTS TERMINATION FOR RECEPTACLES

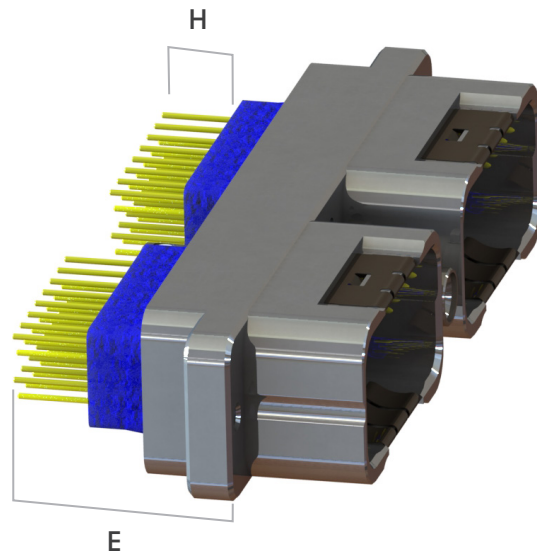

## c-enx™ B2 Composite Shell

Straight PC Tail contact termination					
Min Length E mm (inch)	Min Length H mm (inch)	Gold	Tin-lead	Pure Tin (RoHS)	
14.20 (0.559) (1)	/	YA	ZA	RA	
17.35 (0.683) (1)	/	YB	ZB	RB	
19.20 (0.755) (1)	/	YC	ZC	RC	
23.10 (0.909)	5.0 (0.212)	YD	ZD	RD	

## c-enx™ B2 Weight Optimized Aluminum and Aluminum Shell

Straight PC Tail contact termination					
Min Length E mm (inch)	Min Length H mm (inch)	Gold	Tin-lead	Pure Tin (RoHS)	
14.55 (0.572) (1)	/	YA	ZA	RA	
17.75 (0.698) (1)	/	YB	ZB	RB	
19.55 (0.769) (1)	/	YC	ZC	RC	
23.50 (0.925)	5.40 (0.212)	YD	ZD	RD	

**NOTE:**

(1) These PC tail lengths are not compatible with C-ENX BE and C-ENX BH inserts

# c-enx™ B2 METALLIC SHELL DIMENSIONS

## WITHOUT GROUND BLOCK CLASS N

Receptacle



Plug

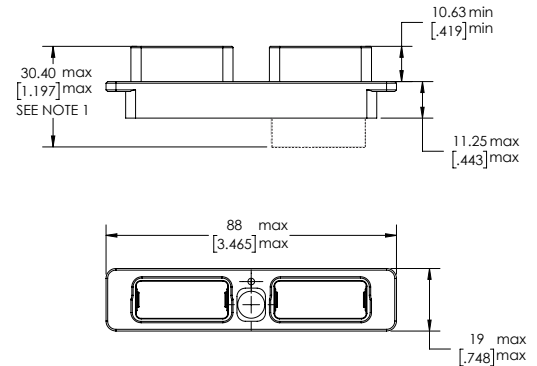

## WITH GROUND BLOCK CLASS N

Receptacle



Plug

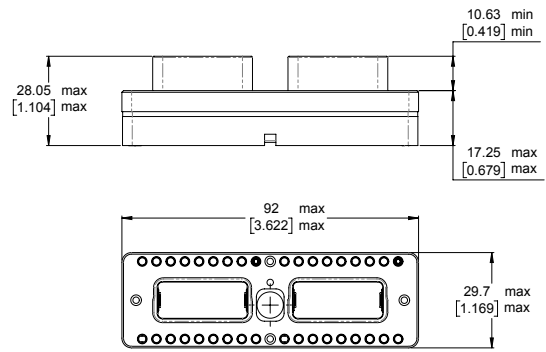

## PANEL CUT OUT CLASS N

Shell mounting code D, F and L

Shell mounting code A

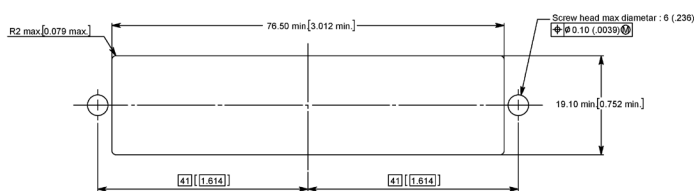

### NOTES:

For inserts with grommets : maximum dimension is shown in the diagram

(1) For inserts without grommets: Insert is flush to the shell Maximum dimension for the receptacle is 25.55 mm (1.006 in) and for the plug is 23.52 mm (0.926 in)

For inserts with optical contacts : the maximum dimension for the receptacle is 38.70 mm (1.524 in) and for the plug is 36.00 mm (1.418 in)

# C-ENX™ B2 COMPOSITE SHELL DIMENSIONS

## PLUG



## RECEPTACLE

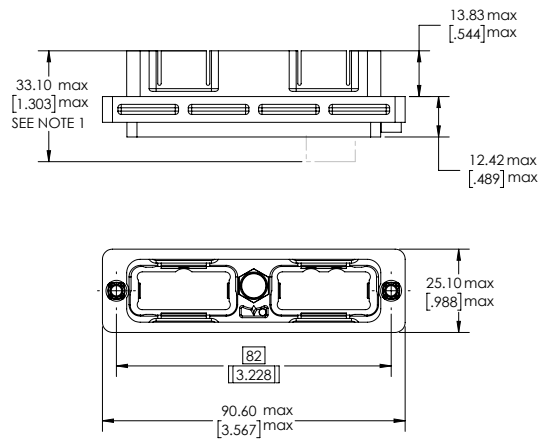

## PANEL CUT OUT

### Shell mounting code D and L



#### NOTE:

(1) For inserts with grommets (C-ENX BE and C-ENX BH) : maximum dimension is shown in the diagram

For inserts without grommets (C-ENX BN): Insert is flush to the shell

Maximum dimension for the receptacle is 25.55 mm (1.006 in) and for the plug is 23.52 mm (0.926 in)











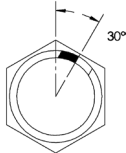

For inserts with optical contacts: the maximum dimension for the receptacle is 38.70 mm (1.524 in) and the plug is 36.00 mm (1.418 in)

# c-enx™ B2 POLARIZATION CODE

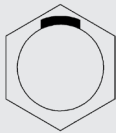

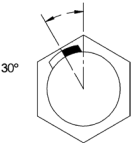
Jackscrews are installed in plugs and jacknuts in receptacle shells. Operator must lock the polarizing device at 1.2 Nm (10.62 Lb-In ) for metallic shell and 0.8Nm (7.08 Lb-In ) for composite shell. Use LOCTITE® 272 to assemble hardware components.

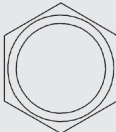
Nut may be fixed with an automatic screwdriver along with the tool bit we provide (PN C-282 664).

Designation	Polarization Code	Coding Device Key	Part Number	
Jackscrew	From A to F		C-617980012	
	From N to Z 30° offset compared to the key of jackscrew P/N C-617980012		C-617980013	
	Universal		C-617980023	
Jacknut	From A to F		C-617980029	
	From N to Z 30° offset compared to the key of jacknut C-617980029		C-617980028	
	Universal		C-617980022	

# c-enx™ B2 POLARIZATION CODE

## PLUG SHELL

Shell reference mark



- = Shell reference mark
- = Coding device key

A	B	C	D	E	F
○	○	○	○	○	○
N	R	W	X	Y	Z
○	○	○	○	○	○

## RECEPTACLE SHELL

Shell reference mark



- = Shell reference mark
- = Coding device key

A	B	C	D	E	F
○	○	○	○	○	○
N	R	W	X	Y	Z
○	○	○	○	○	○

# c-enx™ B2 ACCESSORIES

	Part Number	Description	Assembly Tool <sup>(2)</sup>	Assembly Torque
	C-617922007	Straight strain relief (composite)	C-282664 or C-282665	0.8 Nm (7.08 in-lbs)
	C-617922014	Straight strain relief for fiber optic cable (anodized Aluminum)	C-282664 or C-282665	1.2 Nm (10.62 in-lbs)
	C-617928100	Straight EMI backshell (nickel-plated composite)	Allen wrench 1/4 inch	1.2 Nm (10.62 in-lbs)
	C-617925052	EMI backshell for braid shield termination (nickel-plated Aluminum)	C-282664 or C-282665	1.2 Nm (10.62 in-lbs)
	C-617925054	EMI backshell for screened twisted pair cables (nickel-plated Aluminum)	C-282664 or C-282665	1.2 Nm (10.62 in-lbs)
	C-617925056	Backshell for large sized wire harnesses (nickel-plated Aluminum) (1)	C-282664 or C-282665 and Allen wrench	1.2 Nm (10.62 in-lbs)

NOTE: (1) Not compatible with jackscrew (2) For more details, refer to page 42



# c-enx™ B2 SPARE PARTS

	Part Number	Description
	C-617954101	Grounding spring (for C-ENX B2 Aluminum only)
	C-617980029	Jacknut – A/B/C/D/E/F
	C-617980028	Jacknut – N/R/W/X/Y/Z
	C-617980022	Universal jacknut
	C-617980012	Jackscrew – A/B/C/D/E/F
	C-617980013	Jackscrew – N/R/W/X/Y/Z
	C-617980023	Universal jackscrew
	C-617954002	Dust cap for plug shell (pink color)
	C-617954003	Dust cap for receptacle shell (pink color)
	C-617954004	ESD dust cap plug shell (black color)
	C-617954005	ESD dust cap receptacle shell (black color)



# TOOLS

	Part Number	Description	To be Used With		
			C-ENX A	C-ENX B1	C-ENX B2
	C-282664	1/4 inch hex screwdriver bit to affix the nut of the jackscrew or the jacknut to the C-ENX B2 accessories			X
	C-282665	Spigot wrench to affix the nut of the jackscrew or the jacknut to the C-ENX B2 accessories			X
	C-282666	Allen wrench for 1/4 turn fastener (3/32 inch)	X	X	
	C-282666002	Allen wrench for rear accessories (5/64 inch)		X	
	C-282666001	Allen wrench for jackscrew (9/64 inch)			X
	C-282521002	Insert extraction tool		X	X
	C-282521004	Right angle insert extraction tool		X	X
	C-282521005	Insert extraction tool	X		
	C-617954020	Plastic box to protect wired inserts during handling	X	X	X
	C-F780855000	Hexagonal key 2mm (5/64inch) Flats for sleeve holder removal		X	X
	C-282668001	Tweezers to change polarizing posts and keys		X	

# c-enx™ B1 PRODUCT OVERVIEW

C-ENX B1 rack and panel connector receptacle and plug with accessories.



# c-enx™ B2 PRODUCT OVERVIEW

Detailed view of receptacle and plug with accessories for the C-ENX B2 rack and panel connector.

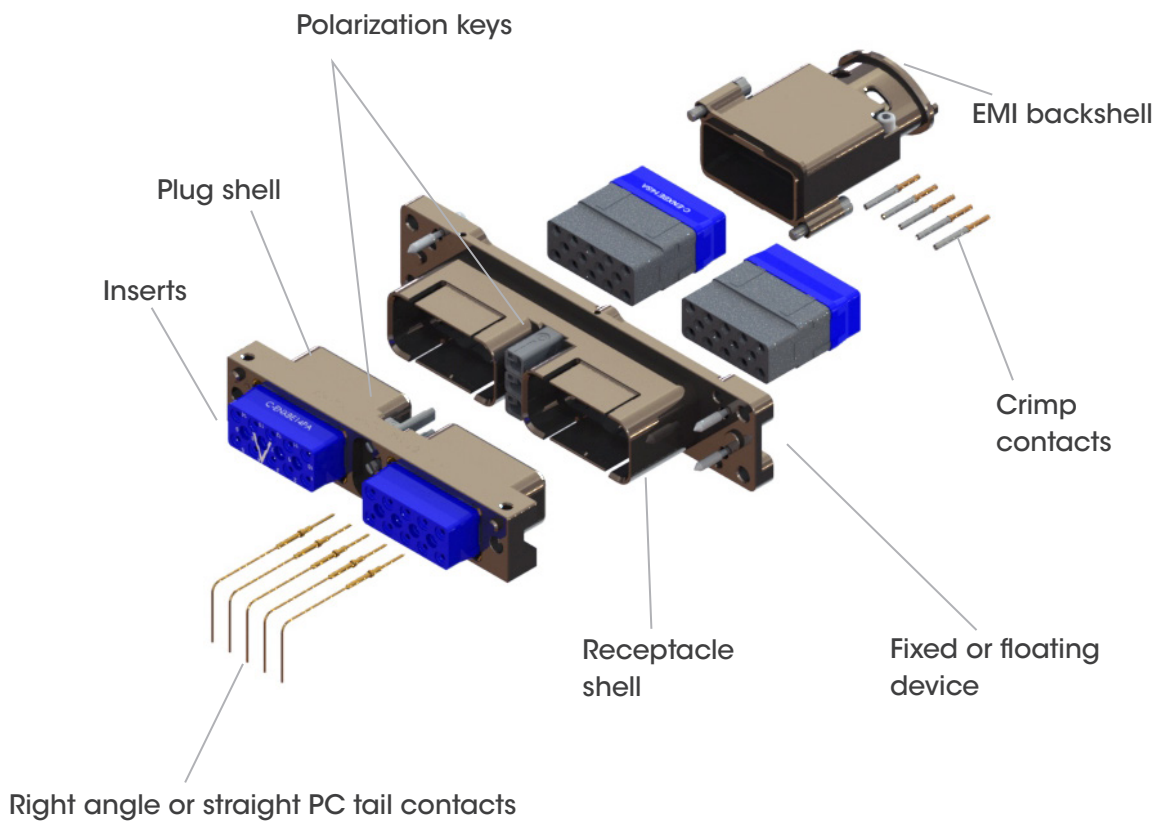

# c-enx™ B3 PRODUCT OVERVIEW

C-ENX B3 rack and panel connector receptacle and plug with accessories.

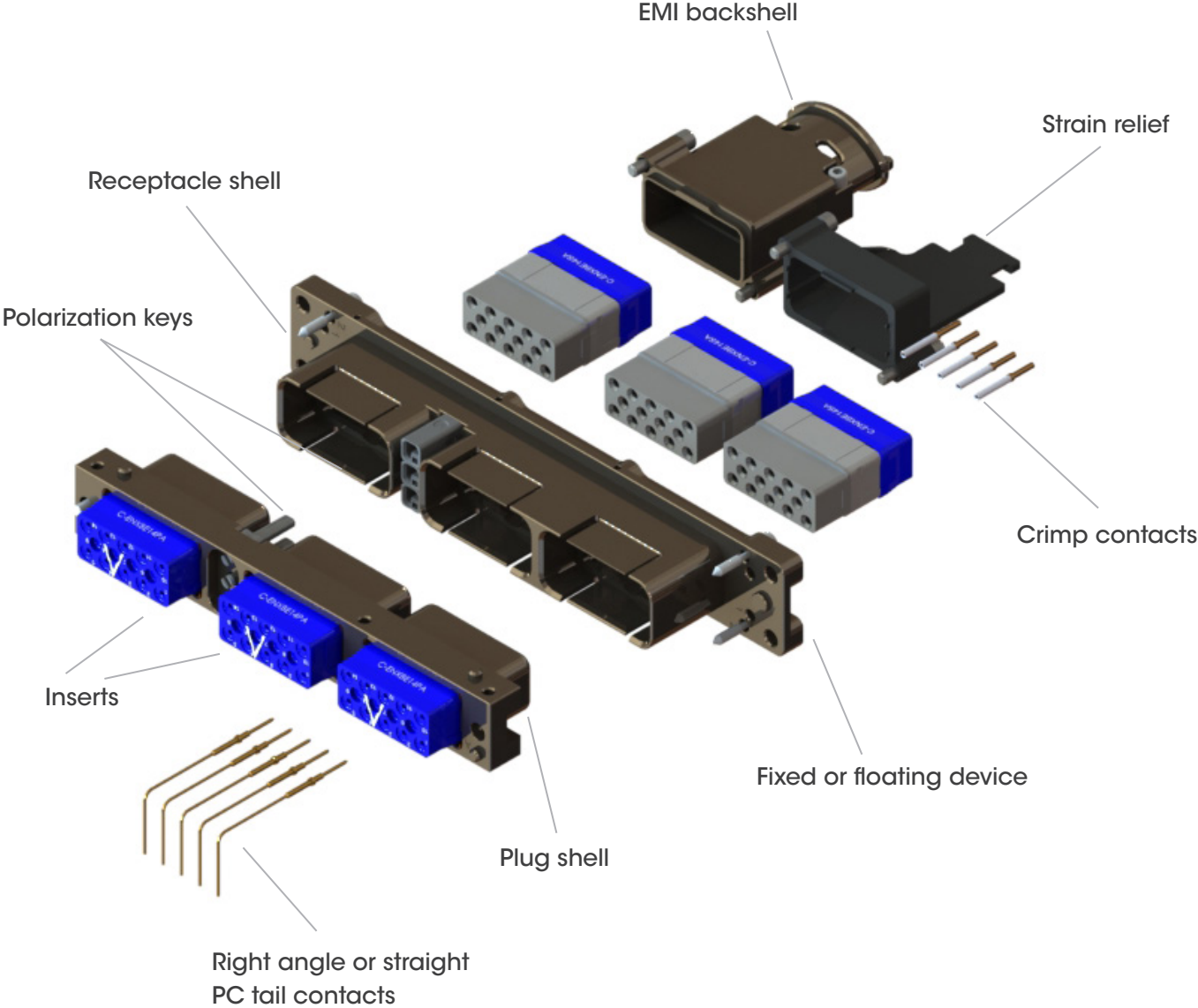

# c-enx™ B4 PRODUCT OVERVIEW

C-ENX B4 rack and panel connector receptacle and plug with accessories.



## HOW TO ORDER c-enx® B1, B2, B3 & B4 SHELL

Shell Selection Part	C-ENX	B3	P	N	1	0
<b>Cinch C-ENX™ Connector</b>						
<b>Shell size</b> B1: One cavity shell B2: Two cavity shell B3: Three cavity shell B4: Four cavity shell						
<b>Shell style</b> P: Plug, nickel-plated R: Receptacle, nickel-plated						
<b>Shell mounting</b> (refer to page 42 for coding) M: Plug, fixed connector with Ø3.96mm holes & 4-40UNC on side N: Plug, fixed connector with 8-32 UNC & 4-40UNC on side S: Receptacle, fixed with 4 x 8-32UNC T: Receptacle, two axis floating with 4 x 8-32 UNC (1)						
<b>Polarization Code</b> 1: Shell delivered with polarizing keys unassembled 2: Shell delivered with no polarizing keys						
<b>Panel cut-out coding</b> A to Z: Receptacle, refer to page 52 for the code selection 0 (zero): Plug, no panel cut out coding						

**NOTE:** (1) This floating option is not available in C-ENX B4 version

# HOW TO ORDER c-enx™ B1, c-enx™ B2, B3 & B4 ASSEMBLY KIT

Shell Selection Part	C-ENX	B4	P	N	0	E	ABCD	YA
<b>Cinch C-ENX™ Connector</b>								
<b>Shell size</b>								
B1: One cavity shell								
B2: Two cavity shell								
B3: Three cavity shell								
B4: Four cavity shell								
<b>Shell style</b>								
P: Plug, nickel-plated								
R: Receptacle, nickel-plated								
<b>Shell mounting</b> (refer to page 47 for codes)								
M: Plug, fixed connector with Ø3.96mm holes & 4-40UNC on side								
N: Plug, fixed connector with 8-32 UNC & 4-40 UNC on side								
S: Receptacle, fixed with 4 x 8-32 UNC								
T: Receptacle, two axis floating with 4 x 8-32 UNC (1)								
<b>Panel cut-out coding</b>								
A to Z: For receptacle, refer to page 52 for the code selection								
0 (zero): For plug, no panel cut out coding								
<b>Insert Selection Part</b>								
<b>Insert class</b>								
E: Environmental								
N: Non-environmental (no rear grommet, no interfacial seal)								
H: Non-environmental insert with a rear grommet (recommended for crimp contact)								
T: Non-environmental insert with interfacial seal (recommended for PC tail contact)								
<b>Insert code</b>								
Refer to page 10 to select code insert								
<b>Contacts termination</b>								
XS: Female insert without contacts								
XP: Male insert without contacts								
SS: Female insert with crimp contacts								
SP: Male insert with crimp contacts								
] These contacts are delivered uninstalled								
YA: Gold PC tail contacts length A								
ZA: Tin-lead PC tail contacts length A								
RA: Pure tin (RoHS) PC tail contacts length A								
] Refer to page 47 to select PC tail contacts for plug								

Delivery includes fully assembled kit with insert mounted into shell. Contacts included only if specified in your order. Place insert codes in the order you want them assembled. Locking and polarizing devices are delivered uninstalled.

## Tips to help you in your selection

- Pin or socket inserts may be used in C-ENX B1, B2, B3, B4 plug or receptacles.
- Crimp contacts available for delivery in a kit, see page 10.
- When PC tail is selected, all cavities are populated (including signal, power and quadrx). Size 5 coax cavities are not populated.
- PC tail contacts are available as pin straight PC tail contacts in receptacles only.

All connector inserts will use the same insert class and contact termination.

**NOTE:** (1) This floating option is not available in C-ENX B4 version

# CONTACTS TERMINATION FOR C-ENX B1, C-ENX B2, C-ENX B3 and C-ENX B4 Plugs

Straight PC Tail contact termination				
Mini Length E mm (inch)	Mini Length H mm (inch)	Gold	Tin-lead	Pure Tin (RoHS)
10.60 (0.417) (1)	/	YA	ZA	RA
13.80 (0.543) (1)	/	YB	ZB	RB
15.60 (0.614) (1)	/	YC	ZC	RC
19.55 (0.769)	5.40 (0.212)	YD	ZD	RD

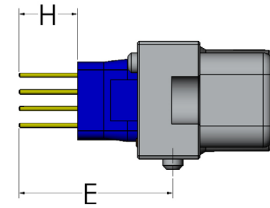

Right Angle PC Tail contact termination <sup>(2)</sup>				
Mini Length F mm (inch)	Mini Length Emm (inch)	Gold	Tin-lead	Pure Tin (RoHS)
2.20 (0.086)	12.85 (0.505) (1)	GA	LA	TA
3.60 (0.141)	20.10 (0.791)	GB	LB	TB
3.60 (0.141)	12.85 (0.505) (1)	GC	LC	TC
2.20 (0.141)	20.10 (0.791)	GD	LD	TD

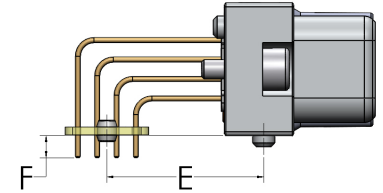

## c-enx™ B Shell Mounting

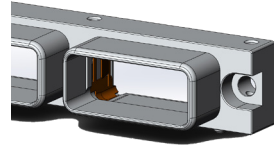
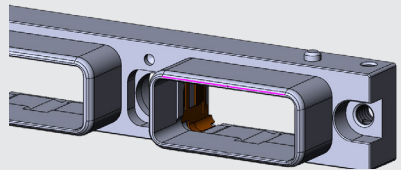
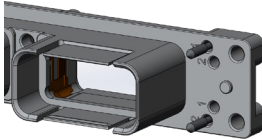
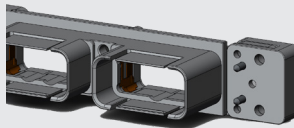
Receptacle Side	Code	Plug Sides
N/A	M	Fixed connector with Ø 3.96 mm holes & 4-40 UNC front or side mount
		
N/A	N	Connector with 8-32 UNC & 4-40 UNC front or side mount
		
Fixed with 4 x 8-32 UNC panel rear mount	S	N/A
		
Floating with 4 x 8-32 UNC panel rear mount	T	N/A
		

### NOTES:

(1) These PC tail lengths are not compatible with C-ENX BE and C-ENX BH inserts

(2) Right angle PC tail lengths GA, LA, TA and GD, LD, TD are not available for #5 and #8 power contacts

# c-enx™ B1 SHELL DIMENSIONS & PANEL CUT-OUTS

## RECEPTACLE

Fixed Mount

Floating Mount

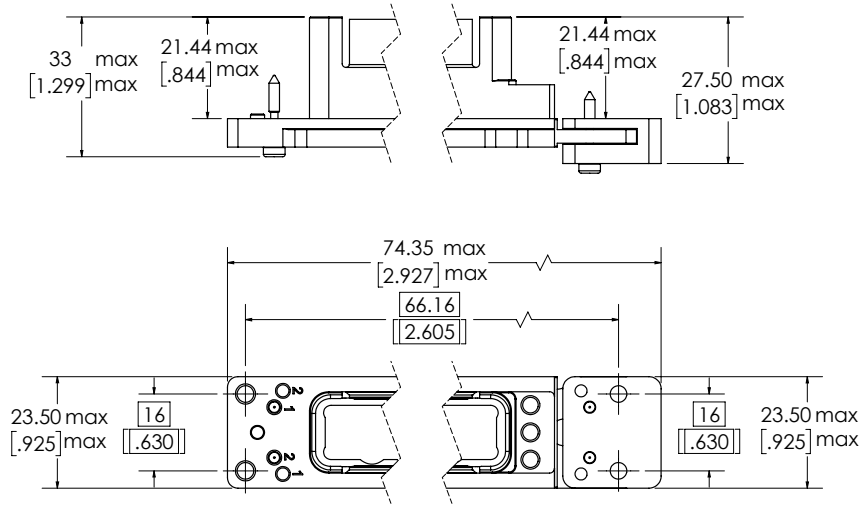

## PLUG

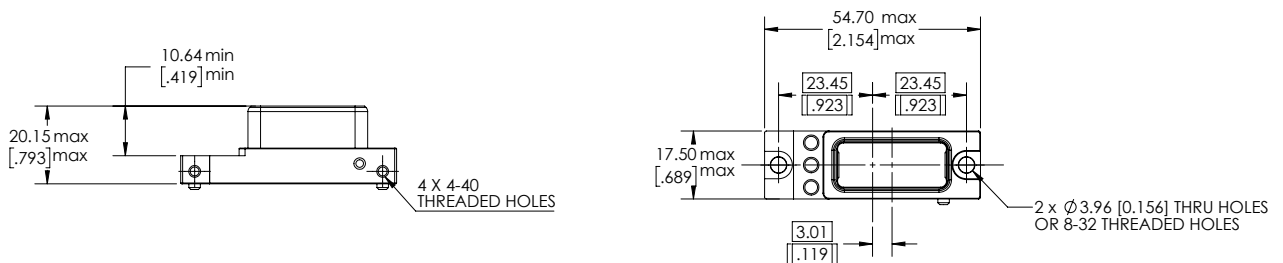

## PANEL CUT OUT (1)

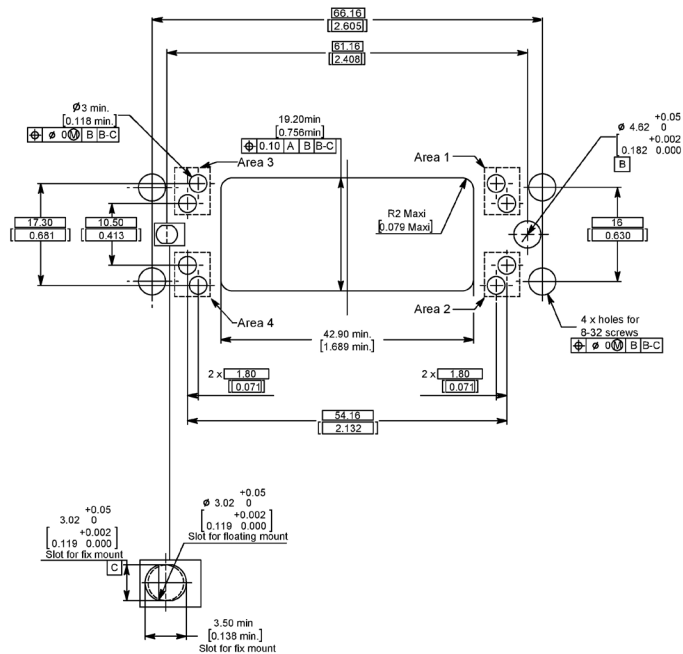

**NOTE:**

(1) The panel cut-out is shown from the rear of the panel



# c-enx™ B2 SHELL DIMENSIONS & PANEL CUT-OUTS

## RECEPTACLE

### Floating Mount

### Fixed Mount

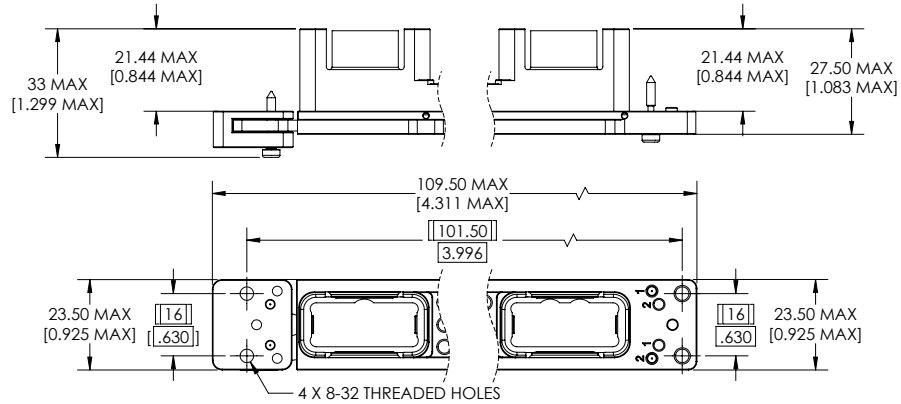

## PLUG

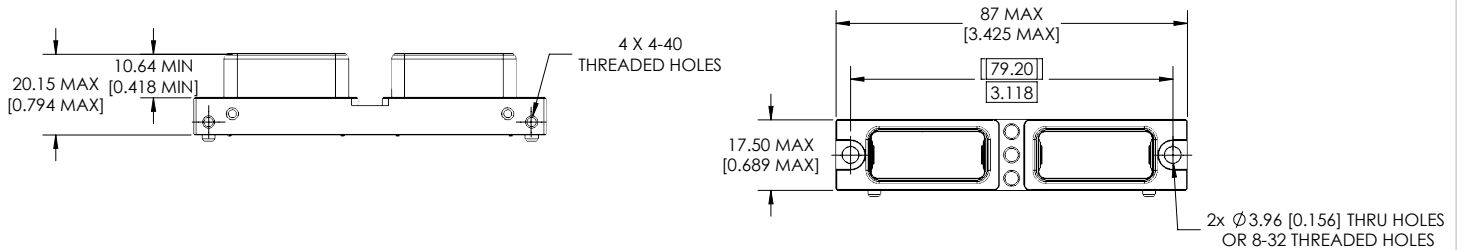

## PANEL CUT OUT (1)

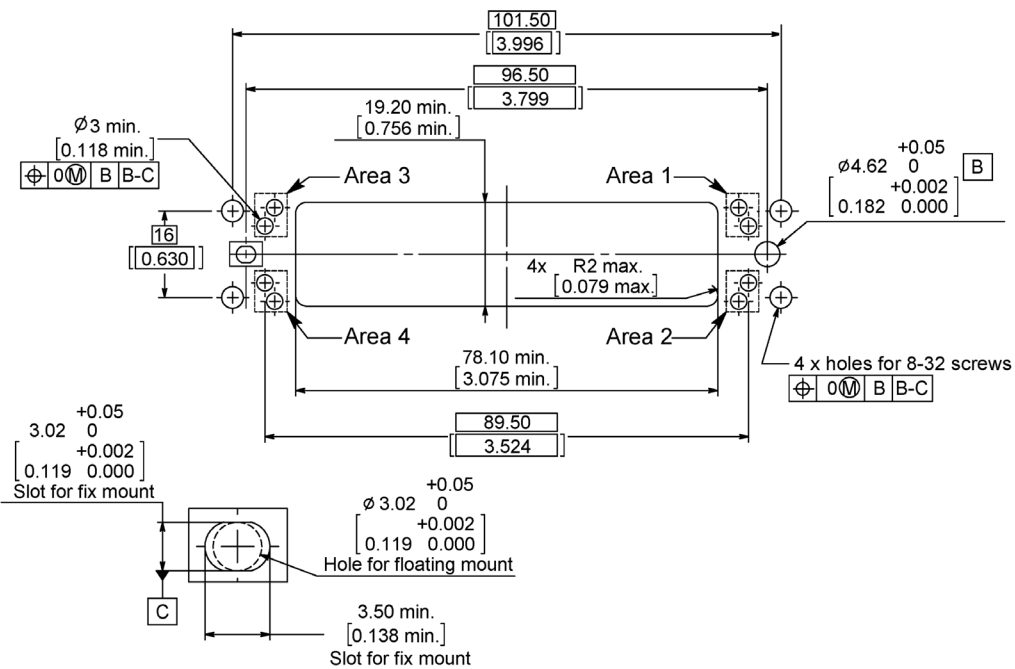

### NOTE:

(1) The panel cut-out is shown from the rear of the panel

# c-enx™ B3 SHELL DIMENSIONS & PANEL CUT-OUTS

## RECEPTACLE

### Floating Mount

### Fixed Mount

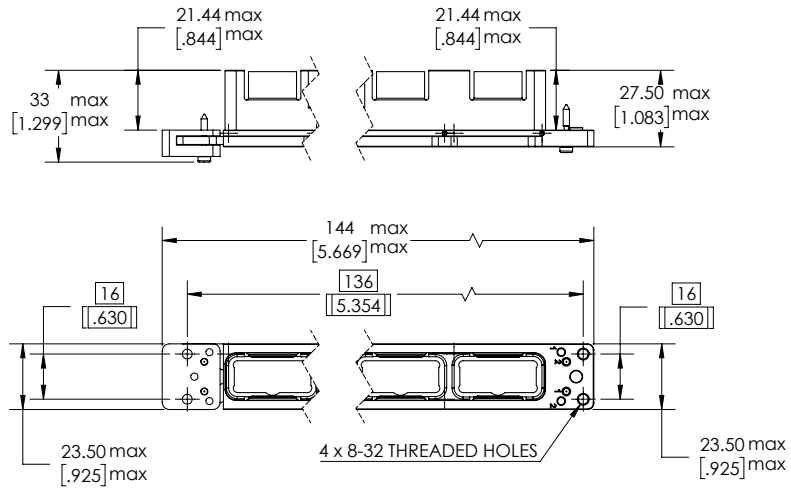

## PLUG

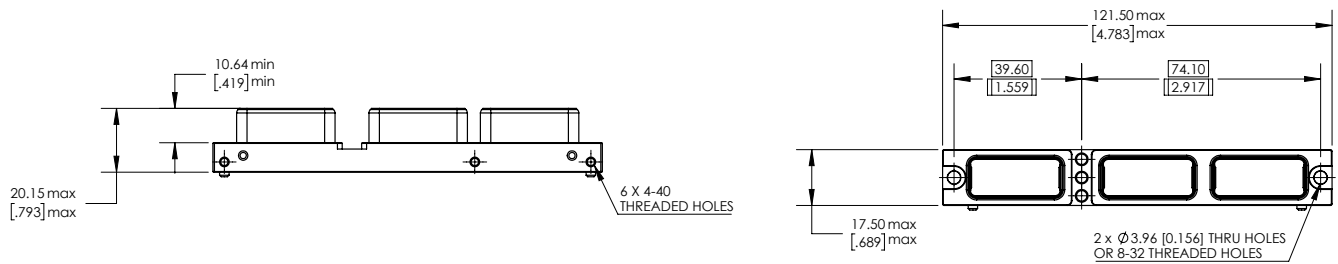

## PANEL CUT OUT (1)

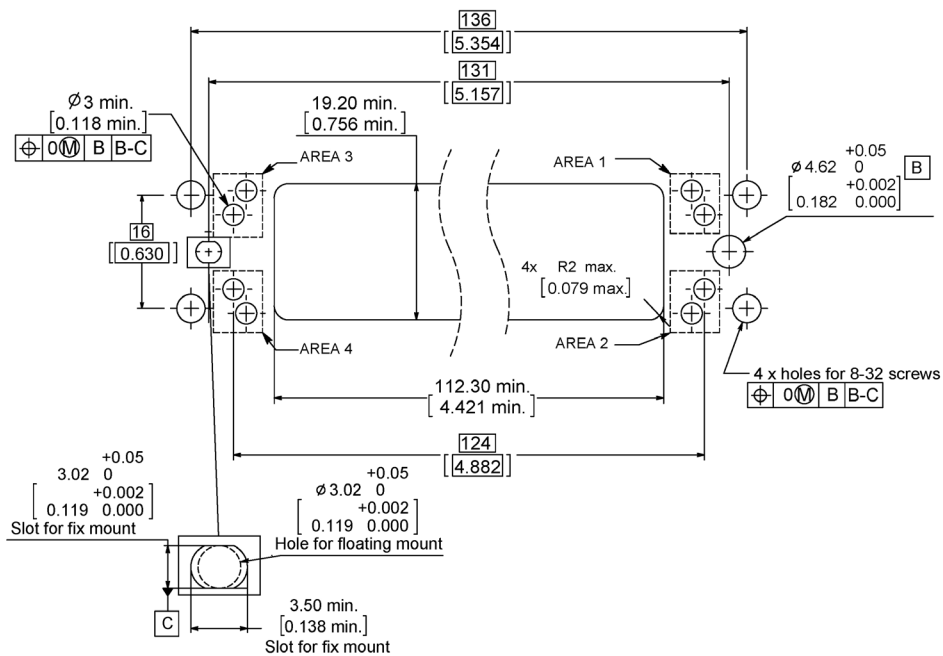

**NOTE:**

⊗ The panel cut-out is shown from the rear to the panel

# c-enx™ B4 SHELL DIMENSIONS & PANEL CUT-OUTS

## RECEPTACLE

### Fixed Mount

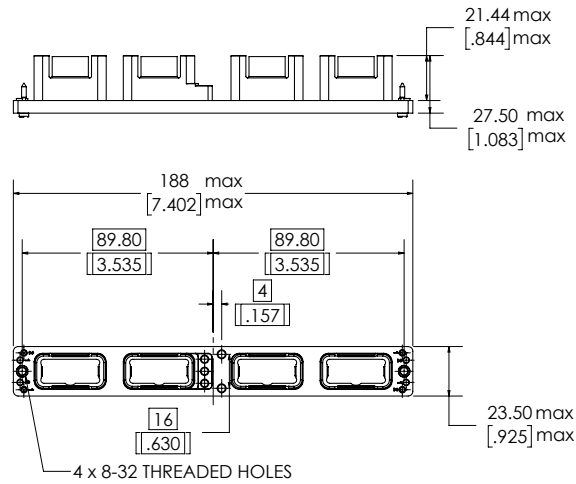

## PLUG

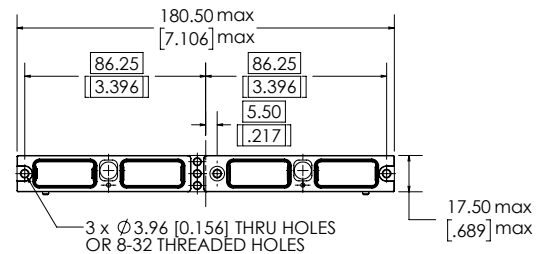
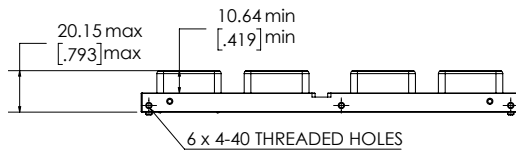

## PANEL CUT OUT (1)

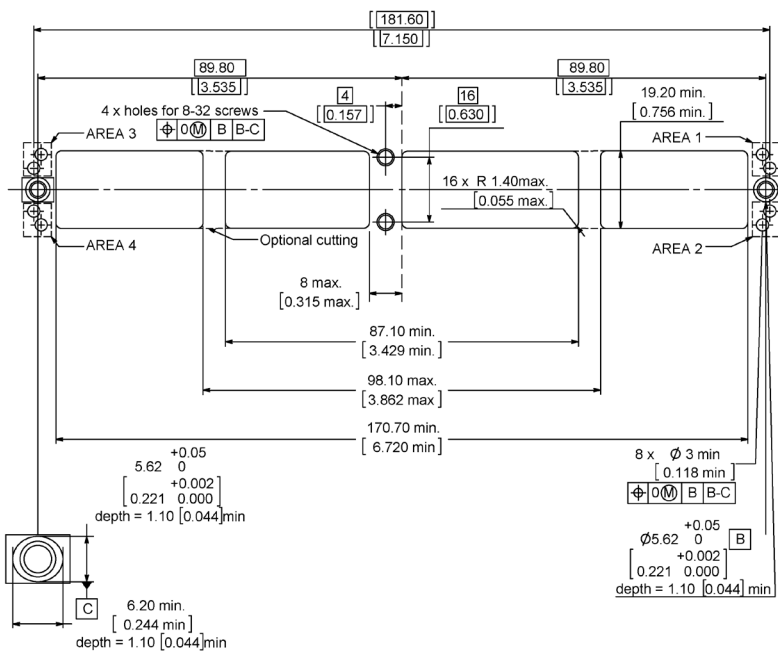

### NOTE:

(1) The panel cut-out is shown from the rear of the panel

# c-enx™ B PANEL CUT-OUT CODING

Coding is available on shells to correlate with the correct panel cut-out for instances where multiple c-enx® B connectors are used with the same equipment.

Four areas are coded on the panel cut out (1 - 4 shown below). One of the two holes should be drilled or each area (n°1 or hole n°2). A coding pin on the shell corresponds to each hole on the panel cut-out.

Panel Cut-out Coding	Panel Hole Number to Drill in Area 1	Panel Hole Number to Drill in Area 2	Panel Hole Number to Drill in Area 3	Panel Hole number to Drill in Area 4
A	Connector delivered with coding device uninstalled			
B	1	1	1	1
C	1	1	1	2
D	1	1	2	1
E	1	1	2	2
F	1	2	1	1
G	1	2	1	2
H	1	2	2	1
J	1	2	2	2
K	2	1	1	1
L	2	1	1	2
M	2	1	2	1
N	2	1	2	2
P	2	2	1	1
R	2	2	1	2
S	2	2	2	1
T	2	2	2	2
Z	Connector delivered without coding pin <sup>(1)</sup>			

## Coding Pins are for Receptacle Only

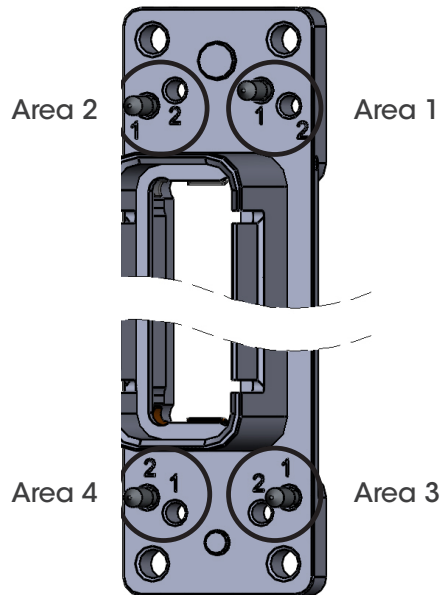

NOTE:  
(1) Z panel cut out coding is only available with fix mounting

Coding C: 1 1 1 2

Hole No 2 drilled in area 1  
 Hole No 1 drilled in area 2  
 Hole No 1 drilled in area 3  
 Hole No 2 drilled in area 4

# c-enx™ B POLARIZATION CODE

## Polarization Code Definitions

Part number includes the polarization device and can be installed as shown below. There are three keys on each shell which can be in four different position.

Polarization keys can have their own position providing codification range.

### Plug size 3

Polarization post

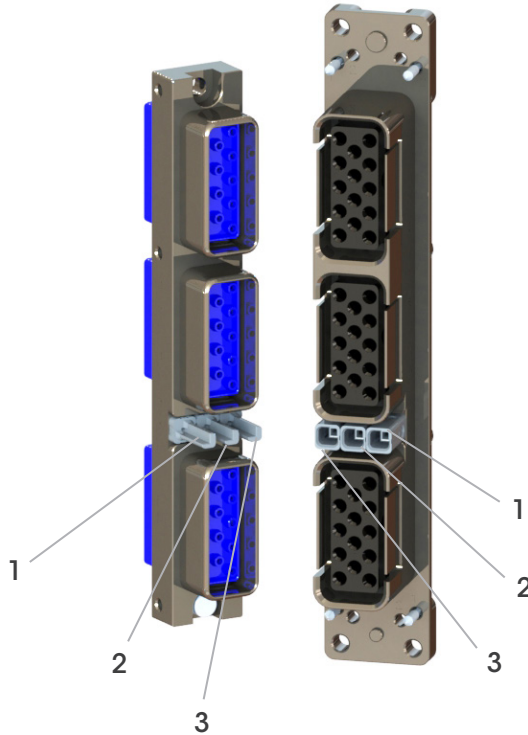

### Receptacle size 3

Polarization key





Connectors are shown front side with cavity A upwards.  
Read your code this way for either C-ENX B2 or C-ENX B3 or C-ENX B4.



# RACK & PANEL ACCESSORIES

	Part Number	Description	Assembly Torque
	C-617925073	EMI backshell for receptacle only (Aluminum nickel-plated)	0.55±0.05 Nm (4.87±0.44 in-lbs)
	C-617922022	Straight strain relief for receptacle only (composite)	0.55±0.05 Nm (4.87±0.44 in-lbs)
	C-617954002	Dust cap for plug shell (pink color)	N/A
	C-617954003	Dust cap for receptacle shell (pink color)	N/A
	C-617954004	ESD dust cap plug shell (black color)	N/A
	C-617954005	ESD dust cap receptacle shell (black color)	N/A
	C-617980052	Coding Pin	0.8 Nm (7 in-lbs)
	C-617980054	Polarization post	N/A
	C-617980055	Polarization key	N/A

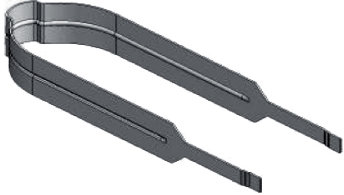
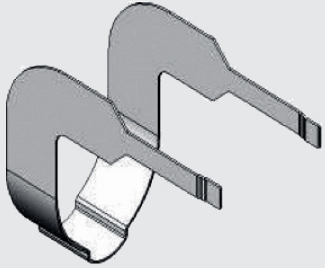
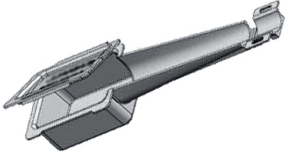
# RACK & PANEL TOOLS

	Part Number	Description	C-ENX B
	C-282521002	Insert extraction tool	X
	C-282521004	Right angle insert extraction tool	X
	C-617954020	Plastic box to protect wired inserts during handling	X
	C-F780855000	Hexagonal key 2mm (5/64inch) Flats for sleeve holder removal	X
	C-282549041	Removal tool for metal coding keys (M81969/30-06)	X

# c-enx™ GALLEY PRODUCT OVERVIEW

Designed for the harsh galley equipment conditions, the c-enx™ B2 Galley connector includes a floating mechanism which guarantees a fully sealed connection and avoids risk of improper mating.

The c-enx™ B2 connector's modular design is ideal for ovens, microwave ovens, refrigerators, beverage makers other equipment meant for standardized galley layouts.

The extra contact density solution makes it easy to add new contacts including the #8 Twinax CAN data bus contact. Backshell accessories are also available.

Detailed view of receptacle and plug with accessories for the C-ENX B2 galley connector.

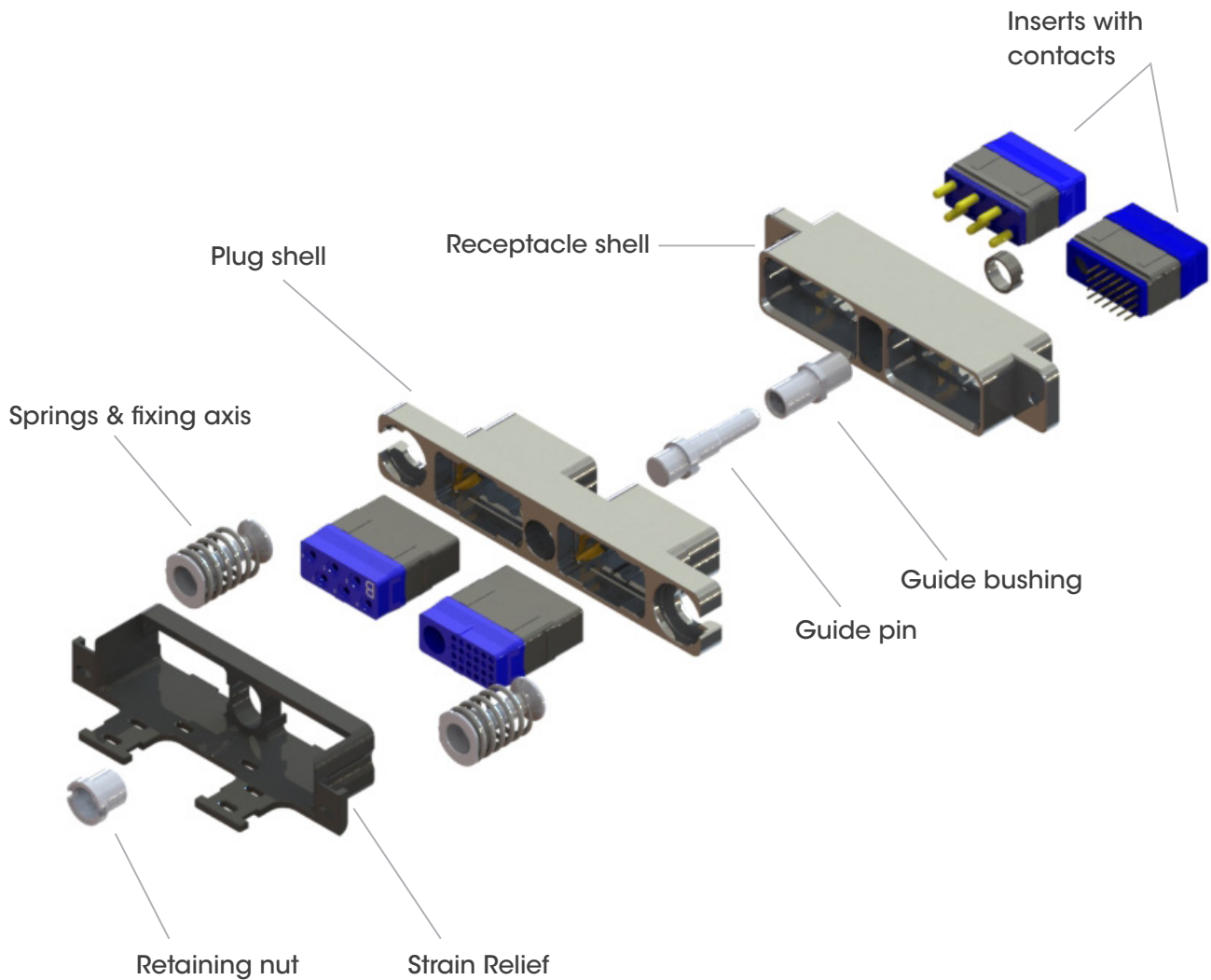



# HOW TO ORDER c-enx™ GALLEY EQUIPMENT CONNECTOR

## Receptacle and Plug Assembly Kit

Part Number	Description
C-617610188 or C-617610558	Receptacle assembled kit (*)
C-617610189	Plug assembled kit (*)

(\*)Part numbers for assembly kits include: plug or receptacle shell, inserts, contacts, sealing plugs and dust caps

Each item included in the kit is indicated in the table below and can also be ordered separately.

## Receptacle Kits

C-617610188 Shell with 2 Self-locking Threaded Holes			C-617610558 Shell with 2 Thru Holes		
Part Number	Description	Quantity per Kit	Part Number	Description	Quantity per Kit
C-617610212	Receptacle shell	1	C-617610419	Receptacle shell	1
C-ENXBE25Q1PA	Insert for cavity A	1	C-ENXBE25Q1PA	Insert for cavity A	1
C-ENXBE06PB	Insert for cavity B	1	C-ENXBE06PB	Insert for cavity B	1
C-617200	Pin crimp contacts/Size 22	15	C-617200	Pin crimp contacts/Size 22	15
C-617250	Pin crimp contacts/Size 12	6	C-617250	Pin crimp contacts/Size 12	6
C-616910	Filler plug	9	C-616910	Filler plug	9
C-617954003	Dust cap	2	C-617954003	Dust cap	2

## Plug Kit

C-617610189 contents

Part Number	Description	Quantity per Kit
C-617610213	Plug shell	1
C-ENXBE25Q1SA	Insert for cavity A	1
C-ENXBE06SB	Insert for cavity B	1
C-617300	Socket crimp contacts/Size 22	15
C-617350	Socket crimp contacts/Size 12	6
C-616910	Filler plug	9
C-617922007	Strain relief	1
C-617954002	Dust cap	2

## Can Data Bus Contact

Part Number	Description
C-617165011	Size 8 Twinax pin contact
C-617065011	Size 8 Twinax socket contact

# c-enx™ GALLEY DIMENSIONS AND PANEL CUT OUT

## RECEPTACLE

### Front Mount

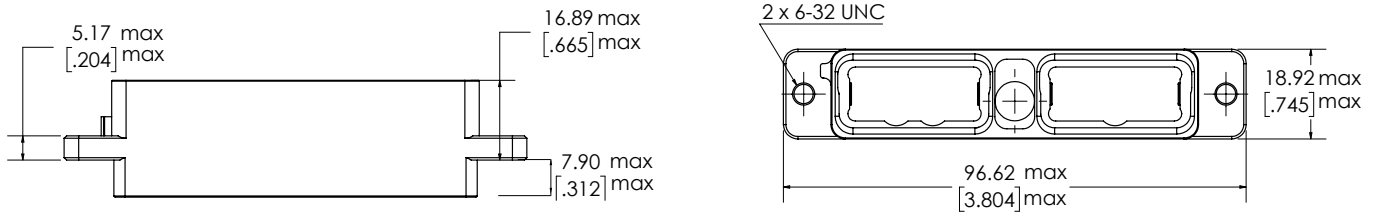

## PLUG

### Rear Mount

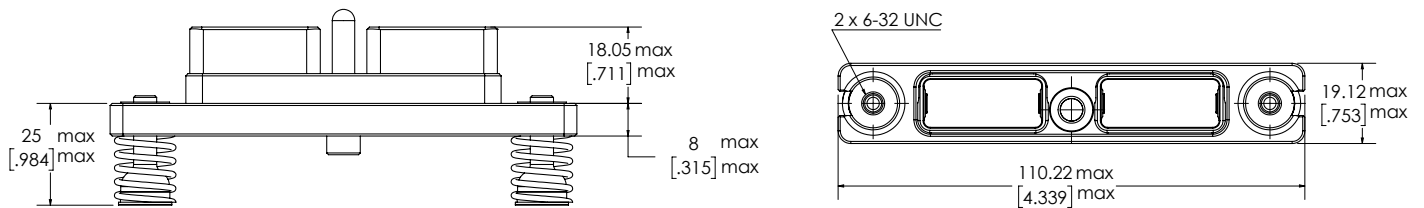

## PANEL CUT OUT

### Receptacle

### Plug

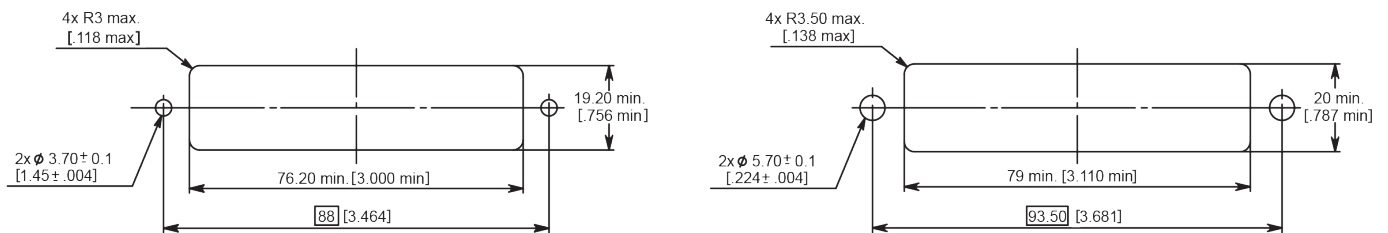

# MULTI-GANG c-enx™ CONNECTORS

Cinch offers a wide range of multigang connectors for rack, panel and disconnect applications.

## Features & Benefits

- Quick and easy installation
- Weight saving design
- Modular design with a wide range of inserts
- c-enx™ connector functionality with c-enx™ B2 standard plug shells and a multigang shell

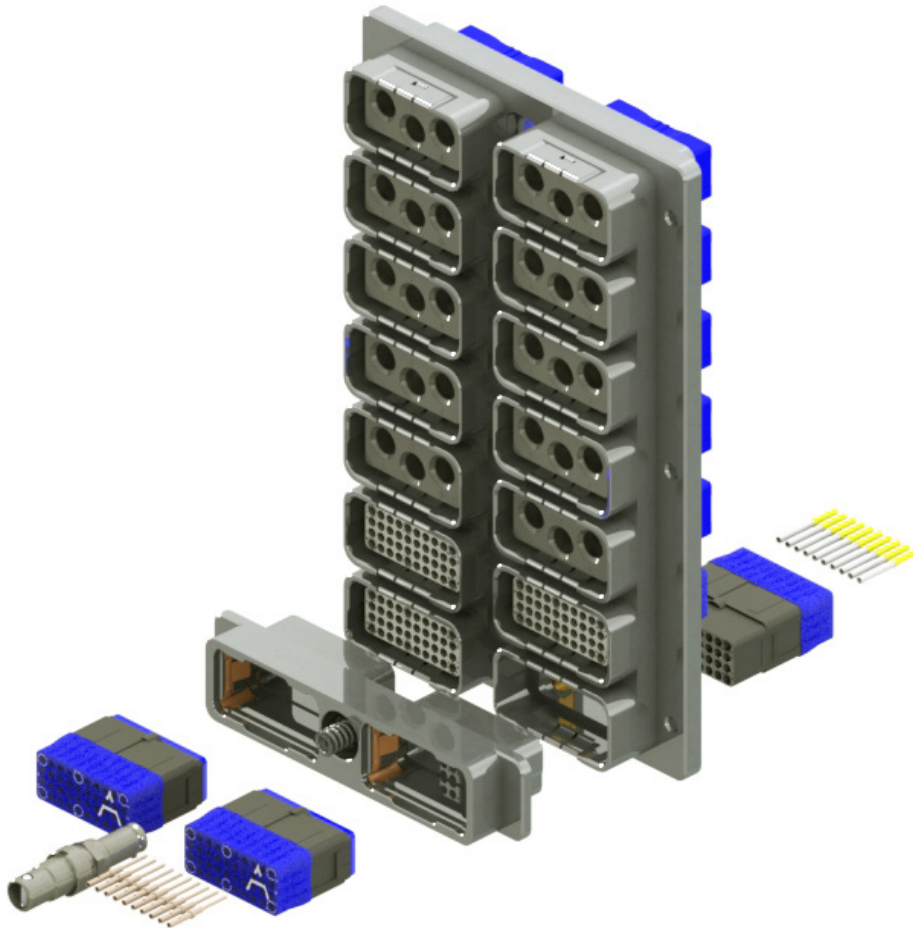

## Specifications

- 4 to 20 cavities for c-enx™ B
- Available with standard c-enx® strain reliefs and backshells
- EN 4644 performance

## Options

- Grounding block
- Grounding spring fingers
- Float mounting
- Spring loaded mounting