

For xDSL Line Transformers & Splitter Coils

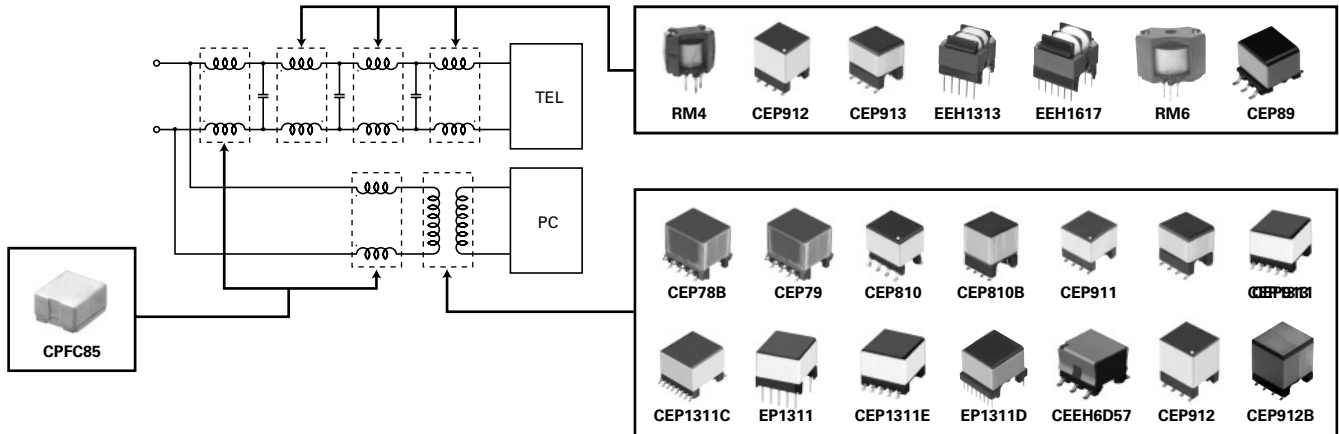

xDSL Line Transformers

OUTLINE / 概要

Application is the xDSL line transformer.
xDSLのライントランスです。

CEP78B



DIMENSIONS (mm) [] : inch 外形寸法図	LAND PATTERNS (mm) [] : inch 推奨ランド寸法	SCHEMATICS 結線図
<p>Max. 8.5 [.335] Max. 9.5 [.374] 1.91 ± 0.2 [0.075 ± .008] 8.0 [0.315] 8.1 [0.319] 8-0.6 ± 0.1 [0.024 ± .004]</p> <p>Pin 1. Pin numbers increment clockwise around the part.</p>	<p>1.9 [0.075] 5.7 [0.225] 2.5 [0.098] 9.0 [0.354] 1.1 [0.043] 6.8 [0.268]</p>	<p>TERMINAL CONNECTION 結線図</p> <p>LINE</p> <p>CHIP</p> <p>• POLARITY (BOTTOM VIEW)</p> <p>DIMENSIONS: mm [inches]</p>

Features / 特徴

- Complies to meet UL60950/IEC60950/EN60950 requirements for working voltages up to 250Vrms.
- Smaller foot print for Central Office applications.
- Lowest Profile.
- Superb THD & Longitudinal Balance
- 250Vrmsまでの使用電圧保護絶縁用としてUL60950/IEC60950/EN60950を取得しています。
- ランド寸法が小さく局内設備に最適です。
- 低背です。
- 歪率、縦電流平衡度に優れています。

Specifications / 仕様

Type Name 型名	Part No. 部品番号	Inductance インダクタンス (nom uH)	Turns Ratio 巻数比 (line:IC)	Insulation	IC Supplier	Chip Set	Application
CEP78B	J10150	1090	0.9:1	Functional	Conexant	Octane, OctanePlus 130, G24 with EL 1528 Driver	ADSL/ADSL2/ADSL2+ CO Annex A/L/M
	J10170	98	0.9:1	Functional	Conexant		ADSL/ADSL2/ADSL2+ CO Annex B
	J10147	1100	0.408:1	Functional	Conexant	Octane, G24 with Le87213A Driver or Le87220 Driver	ADSL/ADSL2/ADSL2+ CO Annex A/L/M
	J10167	98	0.408:1	Functional	Conexant		ADSL/ADSL2/ADSL2+ CO Annex B
	J10204	470	1.2:1	Functional	Broadcom	BladeRunner 2nd Generation (BCM6411, BCM6421)	ADSL/ADSL2/ADSL2+ CO Annex A
	J14104	800	1.1:1	Functional	Conexant	Accellity II	VDSL/VDSL2+ CO over POTS
	J10168	1400	1.333:1	Functional	Infineon	Gemimax	ADSL/ADSL2/ADSL2+ CO Annex A
	J10169	82	1.333:1	Functional	Infineon	Gemimax	VDSL/VDSL2 CO Annex B
	J14108	82	1.333:1	Functional	Infineon	Vinax CO (PEF 88102, PEF 88601)	VDSL/VDSL2 CO Annex B
J14118	82	1.333:1	Supplementary	Infineon	Vinax CPE (PEB 83000)	VDSL/VDSL2 CPE Annex B	

CEP79

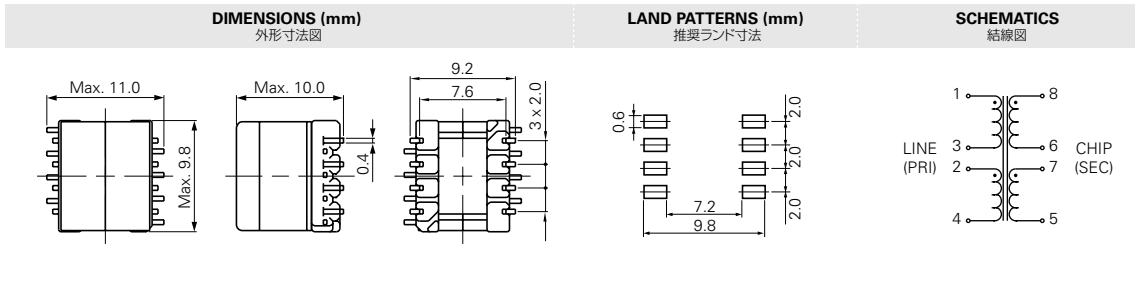
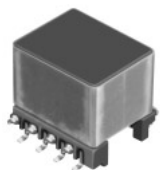

Specifications / 仕様

Impedance / インピーダンス	(1-4)	Designed to reflect 100Ω on the PRI with 100Ω load on Sec.
Inductance / インダクタンス	(1-4)	850μH ±10% (10kHz 0.1V) 2+3 tie / 接続
Turns Ratio / 巻き数比		1 : 1 (±1%) (PRI : SEC) / (1次 : 2次)
Leakage Inductance / 漏れインダクタンス	(1-5)	3.6μH (Typ.) (100kHz 0.1V) 2+3, 6+7 tie / 接続, 5+8 short / 短絡
D.C.R.	(1-3)	1.2Ω (Typ.) (20°C)
	(2-4)	0.9Ω (Typ.) (20°C)
	(5-7)	0.85Ω (Typ.) (20°C)
	(6-8)	0.8Ω (Typ.) (20°C)
Insertion Loss / 挿入損失		0.1dB (Typ.) (30kHz-1.1MHz)
Total Harmonic Distortion / 歪率		-75dB (Typ.) (40kHz, 5.3Vrms)
		-90dB (Typ.) (100kHz, 5.3Vrms)
Longitudinal Balance / 縦電流平衡度		70dB (Typ.) (100kHz) (6, 7 GND)
Withstand Voltage / 耐電圧		1,875Vrms 1Sec (50Hz/60Hz) between PRI-SEC / 1次 - 2次間

• Features / 特徴

Line transformer for central offices.
局用ライントランスです。

CEP810

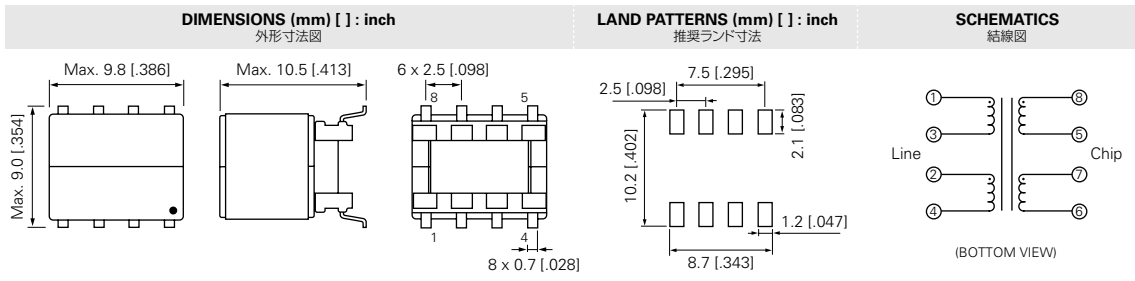

• Features / 特徴

- Complies to meet UL60950/IEC60950/EN60950/BABT/TÜV requirements for working voltages up to 250Vrms.
- Low Profile.
- Superb THD & Longitudinal Balance.
- 250Vrmsまでの使用電圧保護絶縁用としてUL60950/IEC60950/EN60950/BABT/TÜVを取得しています。
- 低背です。
- 歪率、縦電流平衡度に優れています。

Specifications / 仕様

Type Name 型名	Part No. 部品番号	Inductance インダクタンス (nom uH)	Turns Ratio 巻数比 (line:IC)	Insulation	IC Supplier	Chip Set	Application	
CEP810	C10204	420	1.2:1	Basic	Broadcom	BladeRunner, 2nd Generation (BCM6411, BCM6421)	ADSL/ADSL2/ADSL2+ CO Annex A	
	C14103	800	2:1	Basic	Conexant	Accelity	VDSL/VDSL2 CO over POTS	
	C14103	800	2:1	Basic	Conexant	Accelity/Accelity II	VDSL/VDSL2 CPE over POTS	
	C10107	1000	0.9:1	Functional	Conexant	Octane, OctanePlus 130, G24 with EL1528 Driver	ADSL/ADSL2/ADSL2+ CO Annex A/L/M	
	C10203	99	0.9:1	Basic	Conexant		ADSL/ADSL2/ADSL2+ CO Annex B	
	C10197	99	0.9:1	Functional	Conexant		ADSL/ADSL2/ADSL2+ CO Annex B	
	C10176	750	0.408:1	Functional	Conexant		Octane, G24 with Le87213 Driver	ADSL/ADSL2/ADSL2+ CO Annex A/L/M
	C10199	99	0.408:1	Basic	Conexant		Octane, G24 with Le87213/A or Le87220 Driver	ADSL/ADSL2/ADSL2+ CO Annex B
	C10141	99	0.408:1	Functional	Conexant	Octane, G24 with Le87213A or Le87220 Driver	ADSL/ADSL2/ADSL2+ CO Annex B	
	C10138	1100	0.408:1	Functional	Conexant		ADSL/ADSL2/ADSL2+ CO Annex A/L/M	
	C10168	1400	1.333:1	Basic	Infineon	Gemimax	ADSL/ADSL2/ADSL2+ CO Annex A	
	C14109	270	1.333:1	Functional	Infineon	VINAX-CO (138kHz-17MHz)	VDSL/VDSL2 CO Annex B	
	C14119P2	270	1.333:1	Supplementary	Infineon	VINAX-CPE (138kHz-17MHz)	VDSL/VDSL2 CO Annex B	

CEP810B

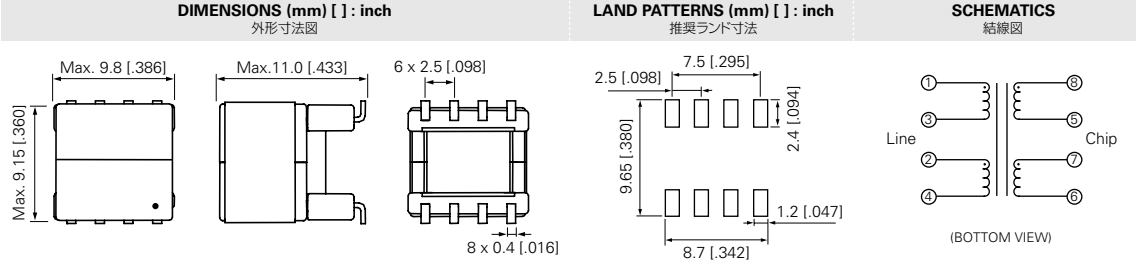

• Features / 特徴

- Complies with CAN/CSA C22.2 No.60950-1, EN60950-1, IEC60950-1 and UL 60950-1 functional insulation requirements for working voltages up to 250Vrms.
- Small space and low height.
- 250Vrmsまでの使用電圧保護絶縁用としてCAN/CSA C22.2 No.60950-1, EN60950-1, IEC60950-1, UL 60950-1 を取得しています。
- 小型低背です。

Specifications / 仕様

Parameter	Line/Chip	Value	Notes
Inductance / インダクタンス	(1-4)	420µH ±10%	(10kHz 0.1V) 2+3 short / 短絡
Turns Ratio / 巻き数比	(1-4) : (8-6)	2 : 1 (±1%)	(100kHz 0.1V) 2+3, 6+7 short / 短絡
Leakage Inductance / 漏れインダクタンス	(1-4)	Max. 1.35µH	(100kHz 0.1V) 2+3, 5+6+7+8 short / 短絡
D.C.R.	(1-4)	Max. 0.9Ω	2+3 short / 短絡
	(8-6)	Max. 0.5Ω	5+7 short / 短絡
Total Harmonic Distortion / 歪率		Max. -65dB	(30kHz, 3.0Vrms)
Longitudinal Balance / 縦電流平衡度	(1-4)	Min. 45dB	(100kHz -12MHz), 2+3 short / 短絡 5+7 grounded
		Min. 42dB	(12MHz -17MHz), 2+3 short / 短絡 5+7 grounded
Interwinding Capacitance	(1-4)	Max. 50pF	(100kHz 0.1V) 2+3, 5+7 short / 短絡
Dielectric Breakdown Isolation	(1-4)	1,500Vrms 1Sec	(0.5mA)
	(1-8)	1,875Vrms 1Sec	(0.5mA), 2+3, 5+6 short / 短絡
	(5-7)	350Vrms 1Sec	(0.5mA)

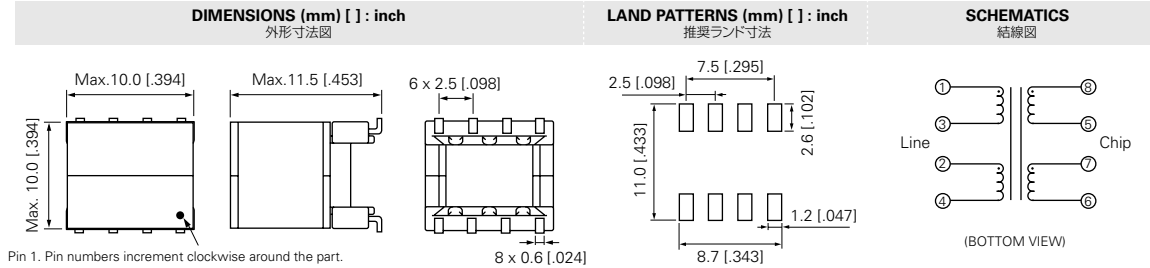
CEP911



• Features / 特徴

- Complies to meet UL60950/IEC60950/EN60950/BABT/TÜV requirements for working voltages up to 250Vrms.
- Low Profile.
- Superb THD & Longitudinal Balance.
- 250Vrmsまでの使用電圧保護絶縁用としてUL60950/IEC60950/EN60950/BABT/TÜVを取得しています。
- 低背です。
- 歪率、縦電流平衡度に優れています。

Specifications / 仕様

Type Name 型名	Part No. 部品番号	Inductance インダクタンス (nom uH)	Turns Ratio 巻き数比 (line:IC)	Insulation	IC Supplier	Chip Set	Application
CEP911	J10107L	1000	0.9:1	Basic	Conexant	Octane, OctanePlus 130, G24 with EL1528 Driver	ADSL/ADSL2/ADSL2+ CO Annex A/LM
	J10149	1200	2.3:1	Supplementary	Analog Devices	Eagle, Eagle-II, Eagle-III, AD6488, AD6485 & AD6486 (Single Transformer Solution)	ADSL/ADSL2/ADSL2+ CPE Annex A/C
	J10217	1200	3:1	Basic	Analog Devices	Eagle, Eagle-II, Eagle-III, AD6488, AD6485 & AD6486 (Transmit for all CPE Solutions)	ADSL/ADSL2/ADSL2+ CPE Annex A/C
	J10218	400	1:1.41	Basic	Analog Devices	Eagle, Eagle-II, Eagle-III, AD6488, AD6485 & AD6486 (Receive for all CPE Solutions)	ADSL/ADSL2/ADSL2+ CPE Annex A/C

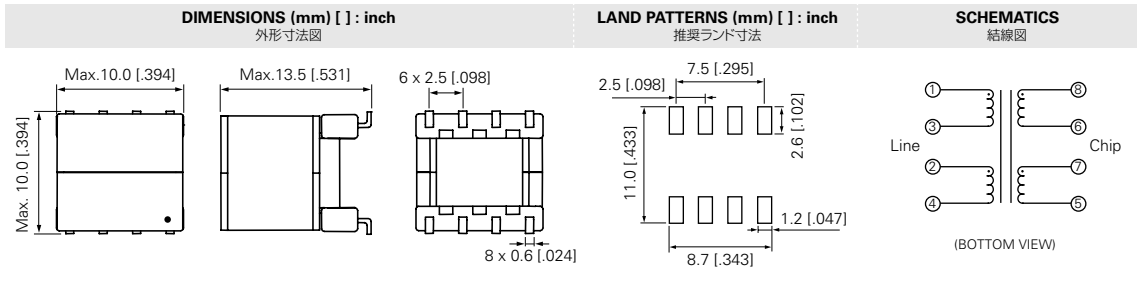
CEP913



Features / 特徴

- Complies with CAN/CSA C22.2 No.60950-1, EN60950-1, IEC60950-1 and UL 60950-1 supplementary insulation requirements at working voltages up to 250Vrms.
- Small space.
- 250Vrmsまでの使用電圧保護絶縁用としてCAN/CSA C22.2 No.60950-1, EN60950-1, IEC60950-1, UL 60950-1 を取得しています。
- 小床面積です。

Specifications / 仕様

Parameter	Symbol	Value	Notes
Inductance / インダクタンス	(1-4)	470μH ±10%	(10kHz 0.1V) 2+3 short / 短絡
Turns Ratio / 巻き数比	(1-4) : (8-5)	1.333 : 1 (±1%)	(100kHz 0.1V) 2+3, 6+7 short / 短絡
Total Harmonic Distortion / 歪率		Max. -80dB	(30kHz, 2.0Vrms)
Leakage Inductance / 漏れインダクタンス	(1-4)	Max. 1.0μH	(1MHz 0.1V) 2+3, 5+6+7+8 short / 短絡
Longitudinal Balance / 縦電流平衡度	(1-4)	45dB (Typ)	(138kHz -12MHz), 2+3 short / 短絡 6+7 ground
D.C.R.	(1-4)	Max. 1.3Ω	2+3 short / 短絡
	(8-5)	Max. 1.0Ω	6+7 short / 短絡
Interwinding capacitance (C _{ww}) / 線間容量	(1-8)	Max. 130pF	(100kHz, 0.1V) 2+3, 6+7 short / 短絡
Dielectric Breakdown Isolation	(1-8)	1,875Vrms 1Sec	(0.5mA), 2+3, 6+7 short / 短絡

CEP1311C

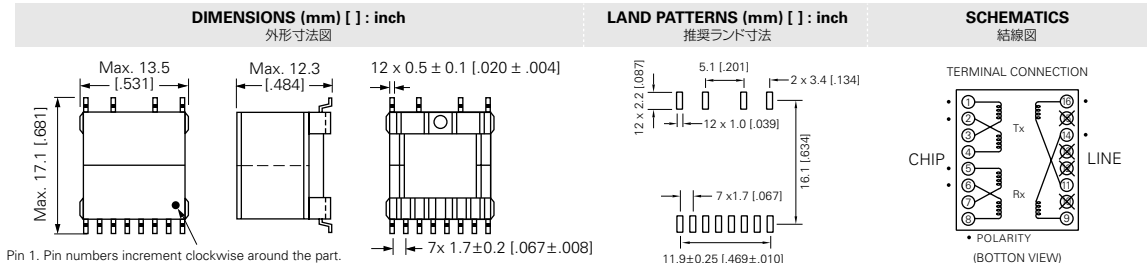
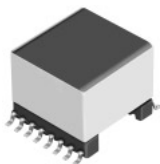

Features / 特徴

- Complies to meet UL60950/IEC60950/EN60950/BABT/TÜV requirements for working voltages up to 250Vrms.
- Superb THD & Longitudinal Balance.
- 250Vrmsまでの使用電圧保護絶縁用としてUL60950/IEC60950/EN60950/BABT/TÜVを取得しています。
- 歪率、縦電流平衡度に優れています。

Specifications / 仕様

Type Name 型名	Part No. 部品番号	Inductance インダクタンス (nom uH)	Turns Ratio 巻数比 (line:IC)	Insulation	IC Supplier	Chip Set	Application
CEP1311C	C14127	100	2.5:1 (line-TX) 1:1 (line-RX)	Supplementary	TI	UR8	ADSL/ADSL2/ADSL2+VDSL/VDSL2 CPE Annex B
	C10113A	700	4:1 (line-TX)	Supplementary	Conexant	Argon 300/330/350/402/432 Centragate USB CX82310/20, CX82320 Endpoint CX85300 CX94510/15 DSRRL100-309 Viking II (Café Series), Viking II Plus	ADSL/ADSL2/ADSL2+ CPE Annex A/C
	C10129B		2:1 (line-RX)				
	C10134	700	4:1 (line-TX)	Supplementary	Conexant	Argon 552	ADSL/ADSL2/ADSL2+ CPE Annex A/C
	C10134C		2:1 (line-RX)				
	C10181	1400	4.2:1 (line-TX) 2:1 (line-RX)	Supplementary	Infineon	Amazon	ADSL/ADSL2/ADSL2+ CPE Annex A/C
	C10301	1400	4.2:1 (line-TX) 2:1 (line-RX)	Supplementary	Infineon	Danube	ADSL/ADSL2/ADSL2+ CPE Annex A/C
	C10302	200	3.8:1 (line-TX) 1:1 (line-RX)				ADSL/ADSL2/ADSL2+ CPE Annex B
	C10125	400	4.25:1 (line-TX) 1:1 (line-RX)	Functional	Broadcom	BCM6301 Driver (5 Volt), BCM6338, BCM6348	ADSL/ADSL2/ADSL2+ CPE Annex A/C
	C10201	400	4.25:1 (line-TX) 1:1 (line-RX)	Supplementary	Broadcom	BCM6301 Driver (5 Volt), BCM6338, BCM6348	ADSL/ADSL2/ADSL2+ CPE Annex A/C
C10202	100	4.25:1 (line-TX) 1:1 (line-RX)	Supplementary	Broadcom	BCM6301 Driver (5 Volt), BCM6338, BCM6348	ADSL/ADSL2/ADSL2+ CPE Annex B	

CEP1311E

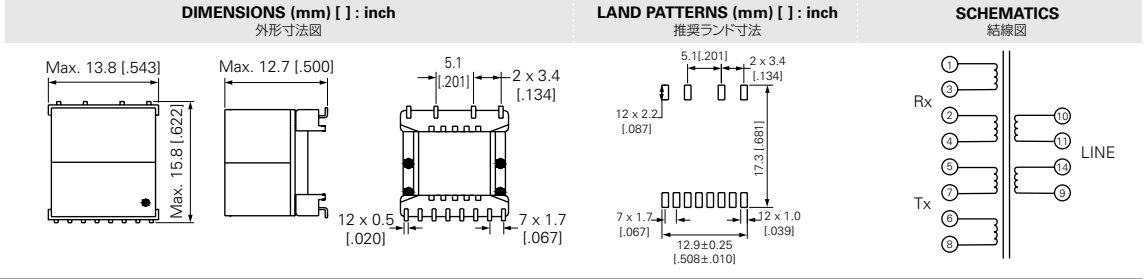
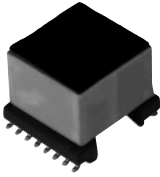

CEP1311

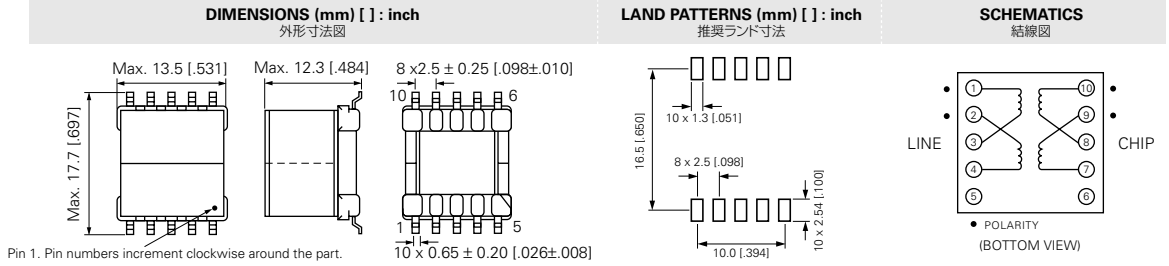

EP1311

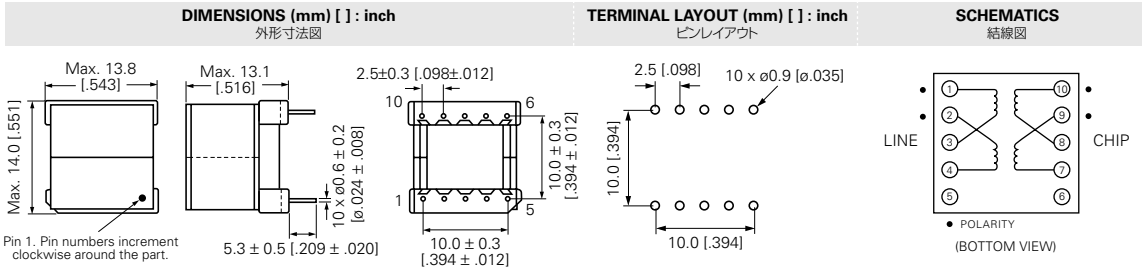
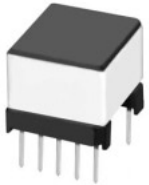

Features / 特徴

- Complies to meet UL60950/IEC60950/EN60950/BABT/TÜV requirements for working voltages up to 250Vrms.
- Superb THD & Longitudinal Balance.
- J lead type of CEP1311C (CEP1311E)
- 250Vrmsまでの使用電圧保護絶縁用としてUL60950/IEC60950/EN60950/BABT/TÜVを取得しています。
- 歪率、縦電流平衡度に優れています。
- CEP1311Cの端子がJリードタイプの製品です。(CEP1311E)

Specifications / 仕様

Type Name 型名	Part No. 部品番号	Inductance インダクタンス (nom uH)	Turns Ratio 巻数比 (line:IC)	Insulation	IC Supplier	Chip Set	Application
CEP1311E	C14206	1500	2.5:1 (line-TX) 1:1 (line-RX)	Supplementary	TI	UR8	ADSL/ADSL2/ADSL2+ CPE Annex A
	C10113C	700	4:1 (line-TX) 2:1 (line-RX)		Conexant	Argon 300/330/350/402/432 Centragate USB CX82310/20, CX82320 Endpoint CX85300 CX94510/15 DSRRL-100-309 Viking II (Café Series), Viking II Plus	ADSL/ADSL2/ADSL2+ CPE Annex A/C
CEP1311	C10120	1500	2:1	Supplementary	TI	AR7 Family	ADSL/ADSL2/ADSL2+ CPE Annex A/C
	C10136	100	2:1		TI	AR7 Family	ADSL/ADSL2/ADSL2+ CPE Annex B
	C14122	560	1:1		PMC Sierra	PM4380 AFE	ADSL/ADSL2/ADSL2+ CPE over POTS
	C14112	750	5.33:1		PMC Sierra	PM4380 AFE	VDSL/VDSL2 CPE over POTS
	C14114	1000	1:1		PMC Sierra	PM4380 AFE	VDSL/VDSL2 CPE over POTS
	C10122	409.5	2:1		Broadcom	12 Volt Driver	ADSL CPE Annex A
EP1311	T10120	1500	2:1	Supplementary	TI	AR7 Family	ADSL/ADSL2/ADSL2+ CPE Annex A/C
	T10136	100	2:1		TI	AR7 Family	ADSL/ADSL2/ADSL2+ CPE Annex B
	T10160	750	4.2:1 (line-TX) 1:1 (line-RX)		Silicon Labs	Si3112 (Single Transformer Solution)	ADSL/ADSL2/ADSL2+ CPE over POTS
	T10195	3000	4.2:1		Silicon Labs	Si3112	ADSL/ADSL2/ADSL2+ CPE over POTS
	T10196	75	0.4:1		Silicon Labs	Si3112	ADSL/ADSL2/ADSL2+ CPE over POTS
	T10122	409.5	2:1		Broadcom	12 Volt Driver	ADSL CPE over Annex A