

FLARE-B

29 x 23 mm lens with ~100° x 10° oval beam

SPECIFICATION:

Dimensions	29.0 x 23.0 mm
Height	12.7 mm
Fastening	glue, screw
ROHS compliant	yes ⓘ

MATERIALS:

Component	Type	Material	Colour	Finish
FLARE-B	Single lens	PMMA	clear	

ORDERING INFORMATION:

Component	Qty in box	MOQ	MPQ	Box weight (kg)
C10946_FLARE-B » Box size: 460 x 250 x 300 mm	1792	224	224	8.6



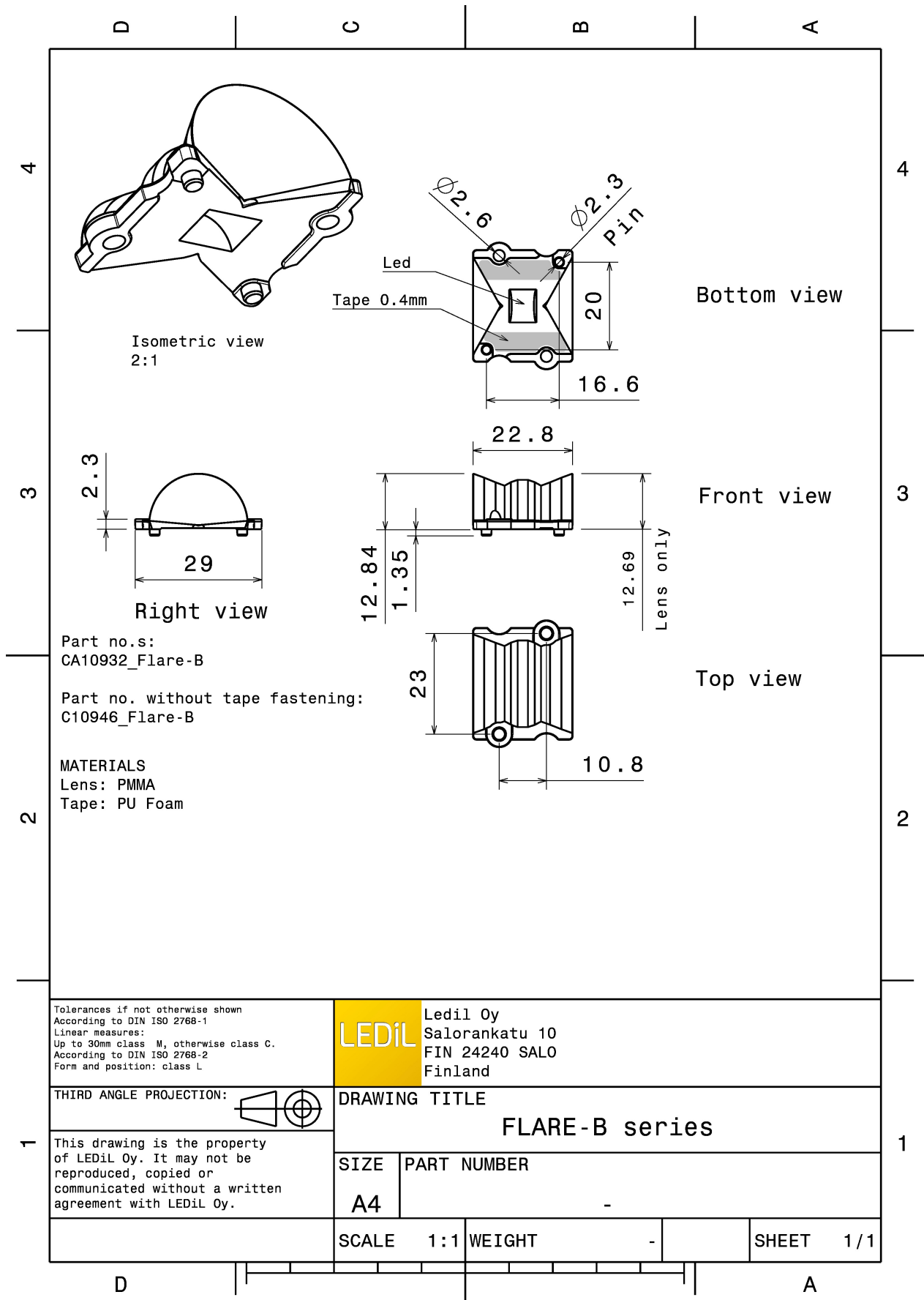

See also our general installation guide: www.ledil.com/installation_guide

OPTICAL RESULTS (MEASURED):



LED XB-D
 FWHM / FWTM 10.0 + 108.0° / 30.0 + 167.0°
 Efficiency 93 %
 Peak intensity 1.5 cd/lm
 LEDs/each optic 1
 Light colour White
 Required components:

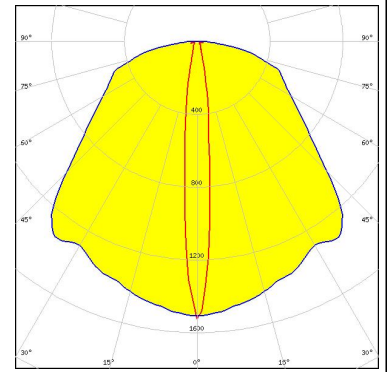

LED XP-E
 FWHM / FWTM 12.0 + 96.0°
 Efficiency 94 %
 LEDs/each optic 1
 Light colour White
 Required components:

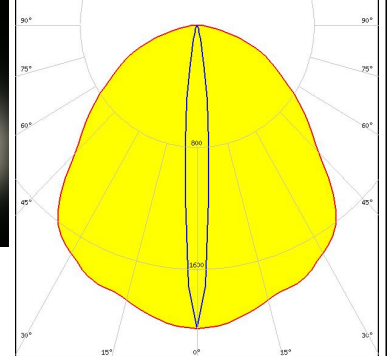

LED XP-G
 FWHM / FWTM 14.0 + 112.0°
 Efficiency 94 %
 LEDs/each optic 1
 Light colour White
 Required components:

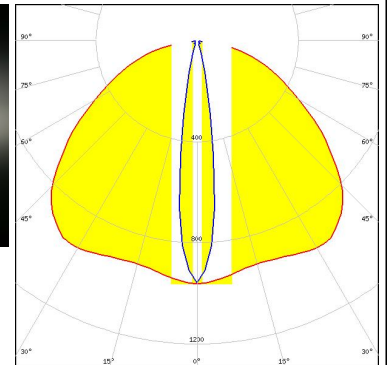
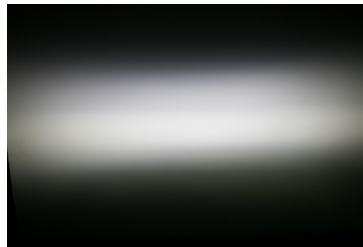

LED LUXEON Rebel
 FWHM / FWTM 11.0 + 93.0°
 Efficiency 94 %
 LEDs/each optic 1
 Light colour White
 Required components:

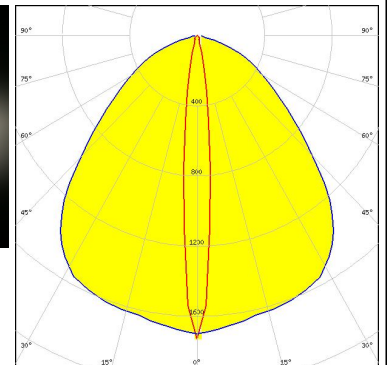
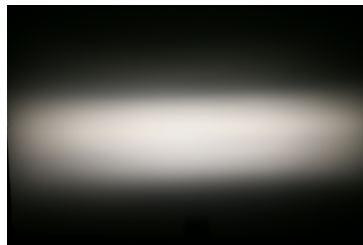

OPTICAL RESULTS (MEASURED):

LUMILEDS

LED LUXEON Rebel ES
 FWHM / FWTM 12.0 + 104.0° / 35.0 + 154.0°
 Efficiency 94 %
 Peak intensity 1.4 cd/lm
 LEDs/each optic 1
 Light colour White
 Required components:

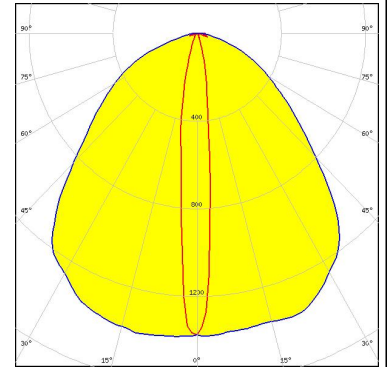

NICHIA

LED NCSxx19A
 FWHM / FWTM 9.0 + 88.0°
 Efficiency 94 %
 LEDs/each optic 1
 Light colour White
 Required components:

NICHIA

LED NVSW219F
 FWHM / FWTM 16.0 + 111.0° / 29.0 + 151.0°
 Efficiency 94 %
 Peak intensity 1.5 cd/lm
 LEDs/each optic 1
 Light colour White
 Required components:

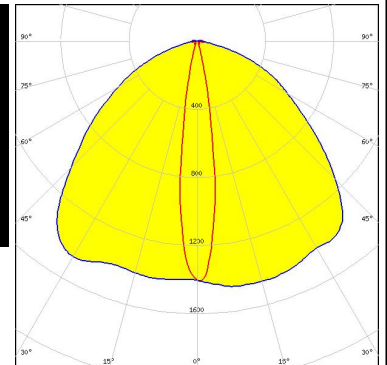
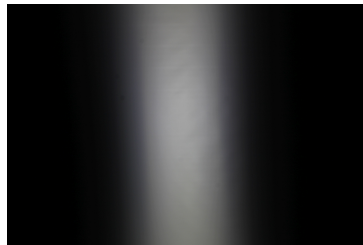

OSRAM

Opto Semiconductors
 LED OSLOM Square EC
 FWHM / FWTM 13.0 + 107.0° / 23.0 + 158.0°
 Efficiency 94 %
 Peak intensity 1.8 cd/lm
 LEDs/each optic 1
 Light colour White
 Required components:

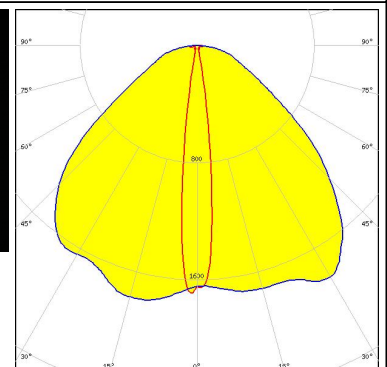
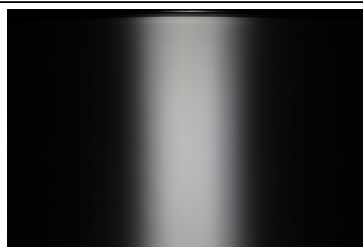

OPTICAL RESULTS (MEASURED):

OSRAM

Opto Semiconductors

LED OSLON SSL 150
 FWHM / FWTM 9.0 + 117.0°
 Efficiency 93 %
 Peak intensity 1.6 cd/lm
 LEDs/each optic 1
 Light colour White
 Required components:

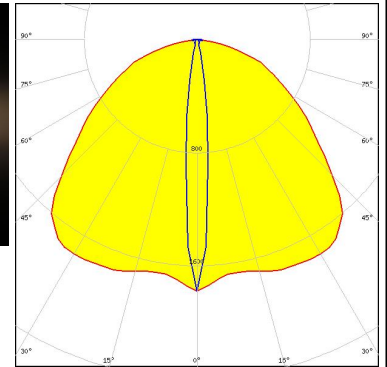

OSRAM

Opto Semiconductors

LED OSLON SSL 80
 FWHM / FWTM 9.0 + 88.0°
 Efficiency 94 %
 LEDs/each optic 1
 Light colour White
 Required components:

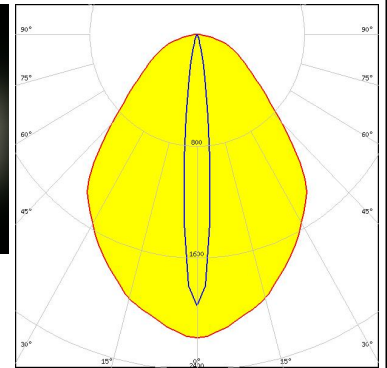
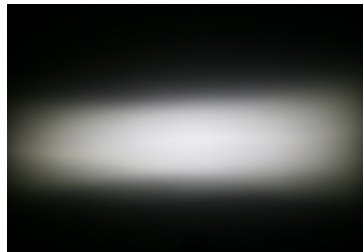

SAMSUNG

LED LH351Z
 FWHM / FWTM 14.0 + 106.0° / 24.0 + 134.0°
 Efficiency 94 %
 Peak intensity 1.9 cd/lm
 LEDs/each optic 1
 Light colour White
 Required components:

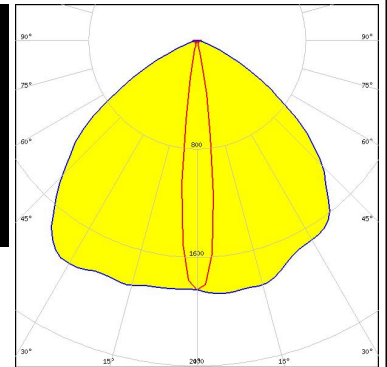
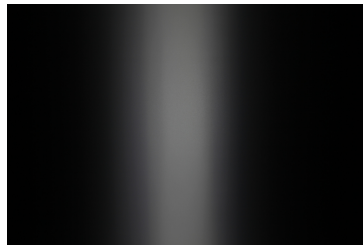

SEOUL SEMICONDUCTOR

LED Z5
 FWHM / FWTM 12.0 + 96.0°
 Efficiency %
 LEDs/each optic 1
 Light colour White
 Required components:

OPTICAL RESULTS (MEASURED):

SHARP

LED	Double Dome (GM2BB)
FWHM / FWTM	11.0 + 104.0°
Efficiency	%
LEDs/each optic	1
Light colour	White
Required components:	



OPTICAL RESULTS (SIMULATED):



LED MHB-A/B
FWHM / FWTM 26.0 + 100.0° / 48.0 + 150.0°
Efficiency 94 %
Peak intensity 1 cd/lm
LEDs/each optic 1
Light colour White
Required components:

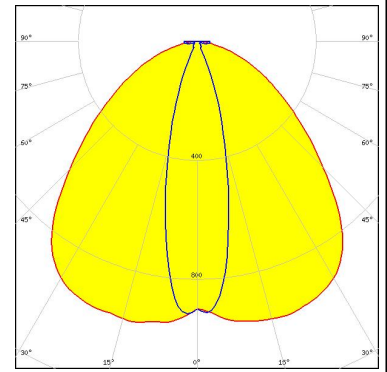

LED XHP50.3 HD
FWHM / FWTM 104.0 + 26.0° / 151.0 + 112.0°
Efficiency 95 %
Peak intensity 1 cd/lm
LEDs/each optic 1
Light colour White
Required components:

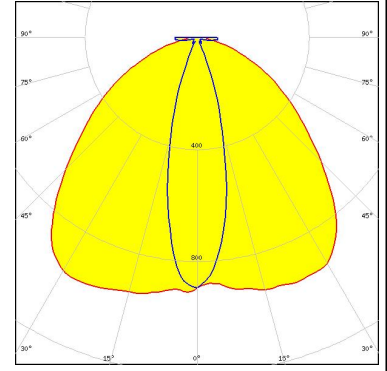

LED XP-E2
FWHM / FWTM 18.0 + 108.0° / 32.0 + 155.0°
Efficiency 94 %
Peak intensity 1.6 cd/lm
LEDs/each optic 1
Light colour White
Required components:

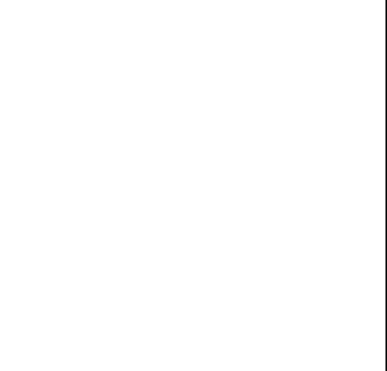

LED XP-G2
FWHM / FWTM 110.0 + 30.0° / 151.0 + 41.0°
Efficiency 96 %
Peak intensity 1 cd/lm
LEDs/each optic 1
Light colour White
Required components:

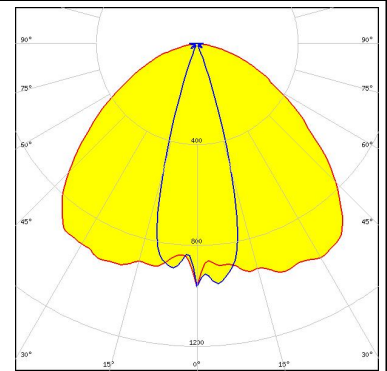

OPTICAL RESULTS (SIMULATED):



LED XP-G2 HE
 FWHM / FWTM 16.0 + 99.0° / 29.0 + 150.0°
 Efficiency 95 %
 Peak intensity 15.2 cd/lm
 LEDs/each optic 1
 Light colour White
 Required components:



LED XP-G3
 FWHM / FWTM 99.0 + 14.0° / 154.0 + 28.0°
 Efficiency 96 %
 Peak intensity 1.6 cd/lm
 LEDs/each optic 1
 Light colour White
 Required components:

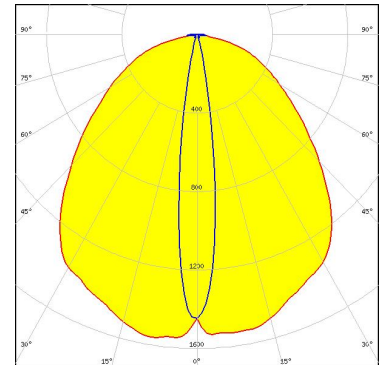

LED Duris S8
 FWHM / FWTM 19.0 + 97.0° / 37.0 + 148.0°
 Efficiency 94 %
 Peak intensity 1.2 cd/lm
 LEDs/each optic 1
 Light colour White
 Required components:

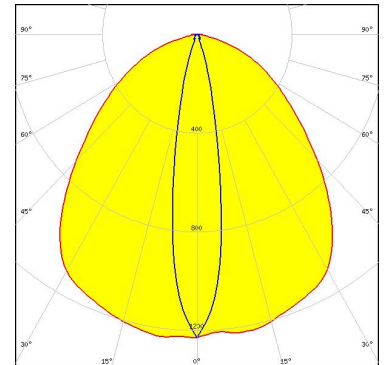

LED OSLOM Signal
 FWHM / FWTM 9.0 + 82.0° / 18.0 + 150.0°
 Efficiency 97 %
 Peak intensity 2.6 cd/lm
 LEDs/each optic 1
 Light colour White
 Required components:

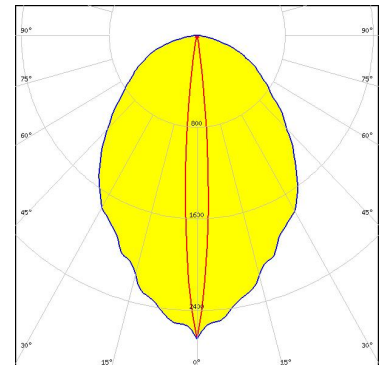

OPTICAL RESULTS (SIMULATED):

OSRAM
Opto Semiconductors

LED OSLON Signal
FWHM / FWTM 8.0 + 80.0° / 18.0 + 149.0°
Efficiency 97 %
Peak intensity 2.8 cd/lm
LEDs/each optic 1
Light colour White
Required components:

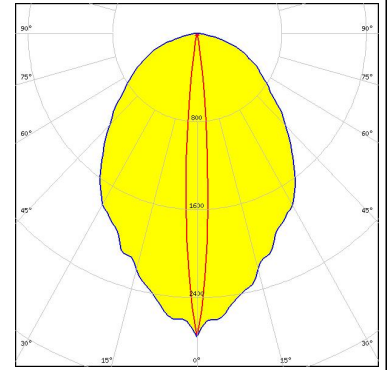

OSRAM
Opto Semiconductors

LED OSLON Signal
FWHM / FWTM 8.0 + 80.0° / 18.0 + 149.0°
Efficiency 97 %
Peak intensity 2.8 cd/lm
LEDs/each optic 1
Light colour White
Required components:

