



5011 | SERIES

1/2" DISC, HERMETICALLY SEALED THERMOSTAT

Introduction

Designed to meet demanding shock and vibration requirements, the 5011 series thermostat is a RoHS compliant, positive snap action, single pole / single throw, hermetically sealed unit. Normally supplied with a grounded case construction, an additional terminal can be provided on the case for a positive ground lead or as an isolated device when the unit is insulated from ground.

The 5011 series can be used for temperature warning or protection. Calibration is factory set and is tamperproof.



Features

- Hermetic glass seal
- Ideal for surface and immersion sensing
- Multiple mounting and terminations available
- Case isolated and case grounded versions

Applications

- Printed circuit board protections
- Air or water cooled engines and transmissions
- Fluid sensing



SPECIFICATIONS

Contact Ratings	<i>Cycles</i>	<i>Voltage</i>	<i>Amps</i>	<i>Case Type</i>
	100,000	120	3 (resistive)	Ground / Insolated case
	100,000	120	2 (inductive)	Isolated case
	100,000	32	3 (resistive)	Grounded case
Contact Operations	Either close on rise (make) or open on rise (break), SPST (Single Pole, Single Throw)			
Operating Temperature	+140°F to 480°F (+60°C to 249°C)			
Temperature Tolerance	Standard of ±5°F with nominal operating temperature settings in 5°F increments			
Long Term Exposure Limit	-65°F to 625°F (-53.8°C to 329.4°C)			
	Note: Please consult the factory if lead wire/terminal exposure temperatures are expected to exceed 220°F. (Refer to inside notes B & C)			
Dielectric Strength	1000 Vrms 60Hz (isolated case) terminals to case (contacts open)			
Insulated Resistance	50 megohms at 500 Vdc			
Thermal Shock	MIL-STD-202, Method 107 Test Condition B			
Materials	Cold-rolled steel, nickel plated enclosure with a glass seal. Applications up to 300°F have a Mylar® sleeve with an epoxy fill, those above 300°F have a Nomex® sleeve and a high temperature epoxy fill.			
	*Exposure limited should be kept to within 100°F of the operating temperature. Consult factory if conditions require otherwise.			



CONTACT OPERATION

CODE	DESCRIPTION
O	Letter "O" = Open on Rise
C	Letter "C" = Close on Rise



TERMINAL SELECTION

A

Pan Head Screw Terminal, #8-32
Grounded Case Only

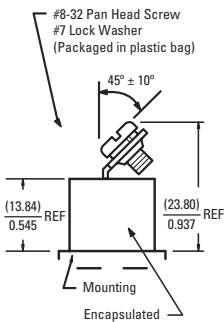
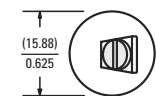

D

Quick Connect Terminal,
Grounded Case Only

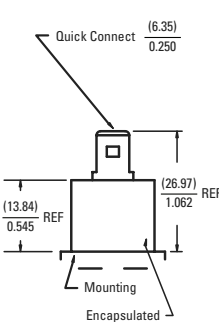
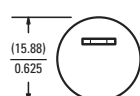

J

2 Pan Head Screw Terminals, #8-32
Isolated Case Only

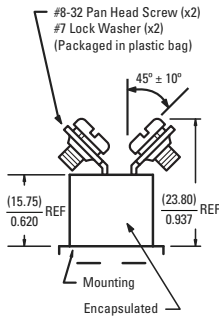
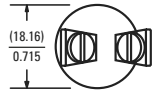

K

2 QC Terminals, Isolated Case Only

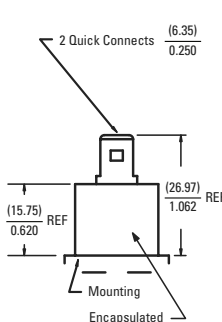
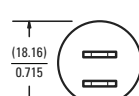

L

2 Leads, Isolated Case Only
See note 1 for lead specifications

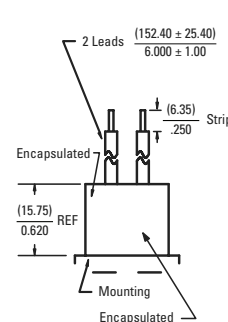

M

Same as terminal selection "L"
Except 2 Leads $\frac{304.80 \pm 25.40}{12.00 \pm 1.00}$
See note 1 for lead specifications

N

Same as terminal selection "L"
Except 2 Leads $\frac{609.60 \pm 25.40}{24.00 \pm 1.00}$
See note 1 for lead specifications

P

Same as terminal selection "L"
Except 2 Leads $\frac{1219.20 \pm 25.40}{48.00 \pm 1.00}$
See note 1 for lead specifications

Z

Special
Requirements
Customer
to Specify



TEMPERATURE CODES AND TOLERANCE

Temperature Scale	Fahrenheit	Celsius	Fahrenheit	Celsius	Fahrenheit	Celsius
Top Temperature Settings	140°F to 250°F	60°C to 121.1°C	251°F to 400°F	121.7°C to 204.4°C	401°F to 480°F	205°C to 248.9°C
Standard Top Temperature Tolerance (code)	±5°F (A)	±2.8°C (A)	±10°F (C)	±5.6°C (C)	±25°F (N)	±13.9°C (N)
Nominal Temperature Differential	25°F	13.9°C	35°F	19.4°C	40°F	22.2°C

Note

- Select any temperature in the range of 140°F to 480°F. Standard choices fall on the 5°F increments, for example 140°F, 145°F, 150°F, 155° F... up to 475°F or 480°F
- Specify the °F temperature in the part numbering scheme as a three digit code without the "°F" in the part number. For example, for 200°F, put in code "200"
- Bottom Temperature in °F equals the "Top Temperature in °F" minus "Nominal Differential in °F". For example 310°F - 30°F = 280°F

Tolerance Code	A	C	N	Y (Bottom Temp Only)
±°F	±5°F	±10°F	±25°F	Minimum
±°C	±2.8°C	±5.6°C	±13.9°C	Minimum

Note

- The standard tolerance for the top temperature is based on the temperature range the top temperature falls in, please refer to the temperature setting chart, and select the appropriate code for a standard top temperature tolerance
- For bottom temperature tolerance a "Y" = minimum trip, which indicates the "reset" trip occurs at or above the lower temperature set point.



MOUNTING AND ENCLOSURE SELECTION

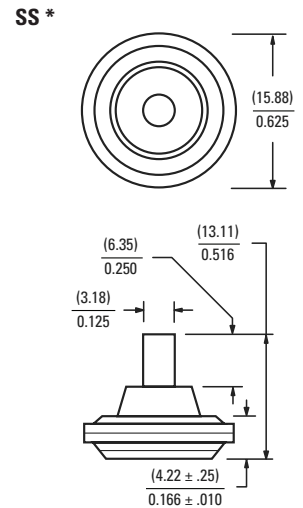
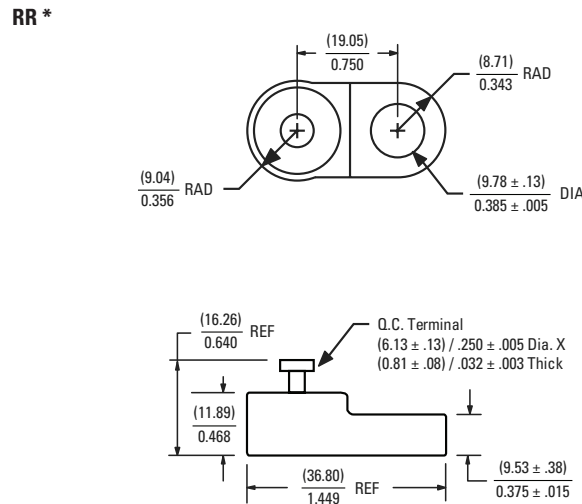
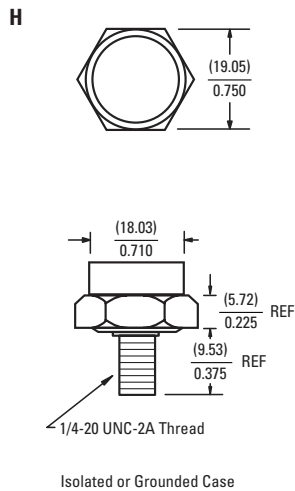
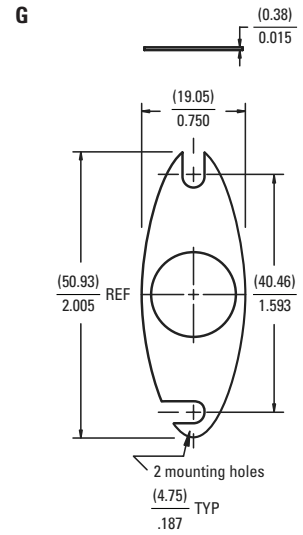
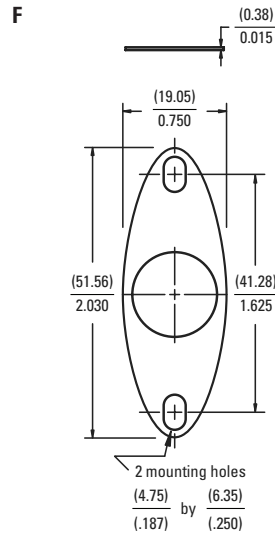
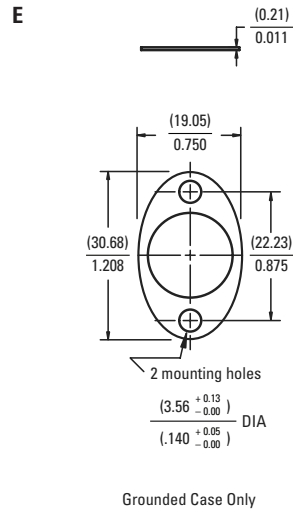
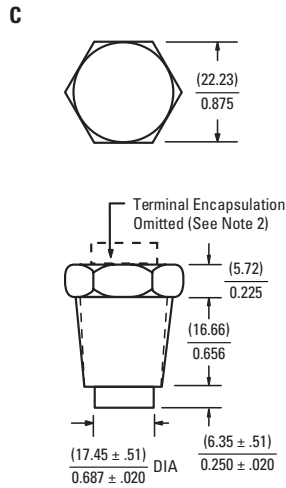

1. The standard lead wire (materials) for different temperature ranges are as follows:

- A. Up to 220°F (104.4°C) = # 18 AWG stranded. UL Style 1015/CSA approved. (PVC insulation, color black)
- B. 221°F to 350°F (105°C to 176.6°C) = #18 AWG stranded. UL Style 1199/CSA approved. (Teflon® TFE insulation, color black)
- C. 351°F (177.2°C) and above = #18 AWG stranded. UL style 5288/CSA approved. (Composite of Teflon®, ceramic + glass braid, color brown)

2. For mounting code "C" only, encapsulation above the hex is omitted and terminal height is reduced by the amount of encapsulation.

3. The marking information on each thermostat will include either the name Sensata, contact operation (CLR) close on rise, (OPR) open on rise, top temperature and date code.

*If you require either of the terminal selections "RR" or "SS", it will require the use of both position 3 (terminal selection). and position 4 (mounting and enclosure selection) in your part number building code. For example: C11RR285C-250Y