

TUIJA-3-M2

~35° medium beam

SPECIFICATION:

Dimensions	Ø 50.0 mm
Height	14.5 mm
Fastening	glue, pin
ROHS compliant	yes ⓘ

MATERIALS:

Component	Type	Material	Colour	Finish
TUIJA-3-M2	Multi-lens	PMMA	clear	

ORDERING INFORMATION:

Component	Qty in box	MOQ	MPQ	Box weight (kg)
C12150_TUIJA-3-M2 » Box size: 480 x 280 x 300 mm	364	112	28	7.0



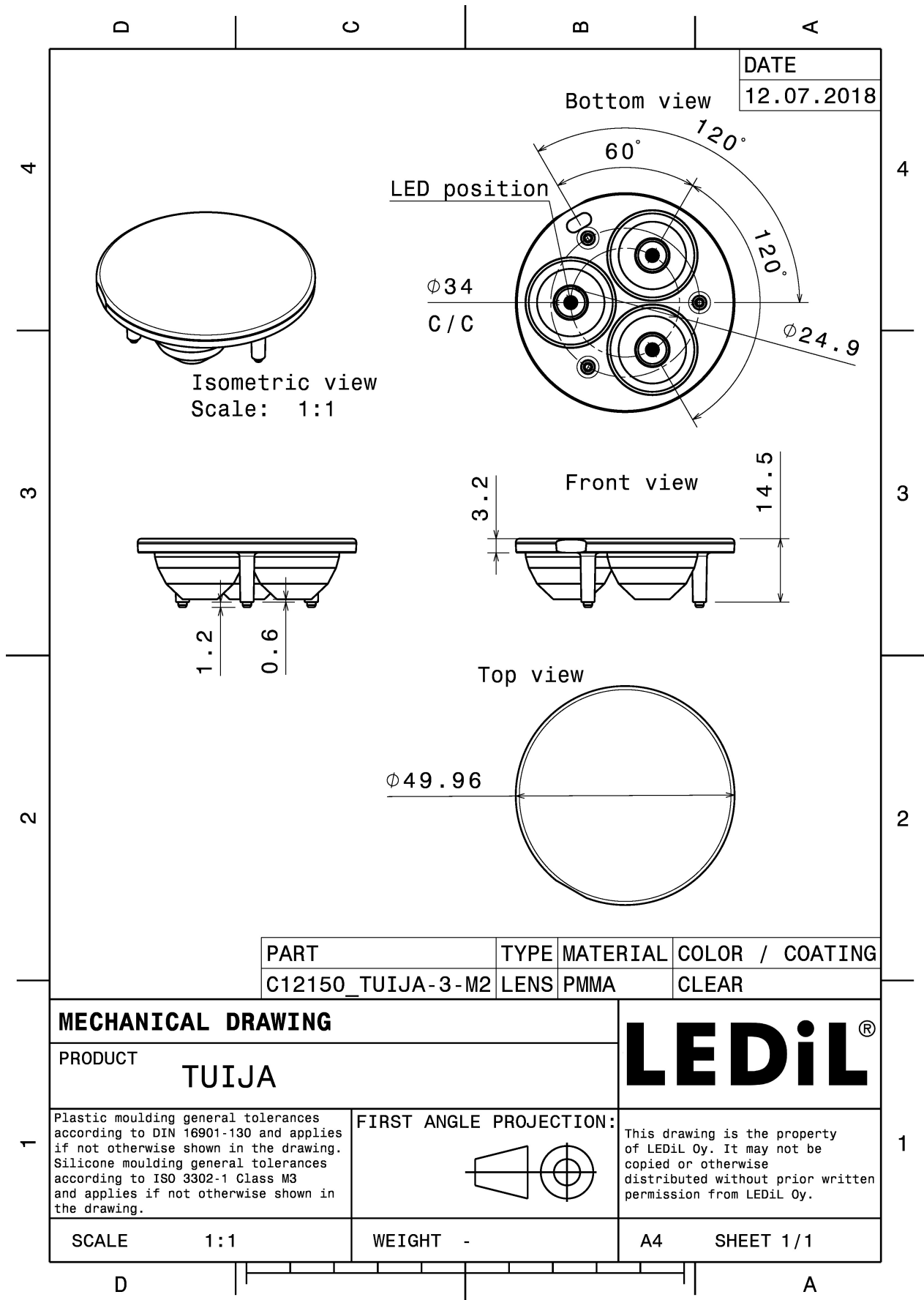

See also our general installation guide: www.ledil.com/installation_guide

OPTICAL RESULTS (MEASURED):



LED XB-D
 FWHM / FWTM 35.0°
 Efficiency 89 %
 Peak intensity 1.9 cd/m
 LEDs/each optic 1
 Light colour White
 Required components:



LED XB-D
 FWHM / FWTM 32.0° / 60.0°
 Efficiency 94 %
 Peak intensity 2.4 cd/m
 LEDs/each optic 1
 Light colour White
 Required components:

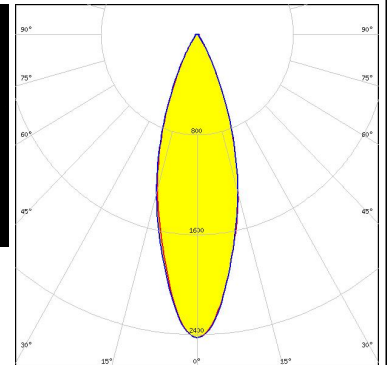

LED XP-E
 FWHM / FWTM 34.0° / 64.0°
 Efficiency 86 %
 Peak intensity 2.2 cd/m
 LEDs/each optic 1
 Light colour White
 Required components:



LED XP-G
 FWHM / FWTM 34.0° / 65.0°
 Efficiency 86 %
 Peak intensity 1.9 cd/m
 LEDs/each optic 1
 Light colour White
 Required components:

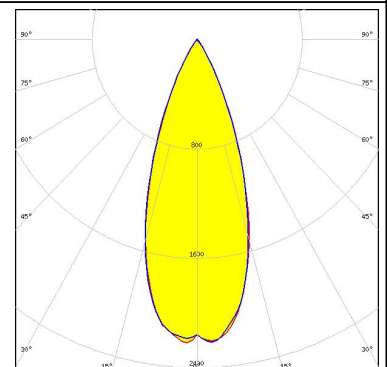

OPTICAL RESULTS (MEASURED):

LUMILEDS

LED LUXEON Rebel
 FWHM / FWTM 37.0° / 66.0°
 Efficiency 89 %
 Peak intensity 1.7 cd/m
 LEDs/each optic 1
 Light colour White
 Required components:

LUMILEDS

LED LUXEON Rebel ES
 FWHM / FWTM 36.0° / 62.0°
 Efficiency 93 %
 Peak intensity 1.8 cd/m
 LEDs/each optic 1
 Light colour White
 Required components:

OSRAM

Opto Semiconductors

LED OSLOM SSL 80
 FWHM / FWTM 40.0° / 64.0°
 Efficiency 87 %
 Peak intensity 1.7 cd/m
 LEDs/each optic 1
 Light colour White
 Required components:

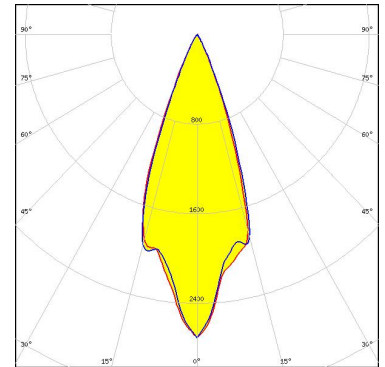

SEOL SEMICONDUCTOR



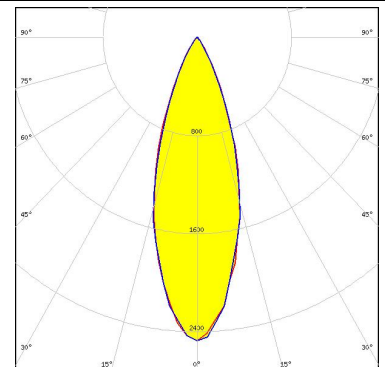

LED Z5
 FWHM / FWTM 32.0° / 60.0°
 Efficiency 92 %
 Peak intensity 2.5 cd/m
 LEDs/each optic 1
 Light colour White
 Required components:

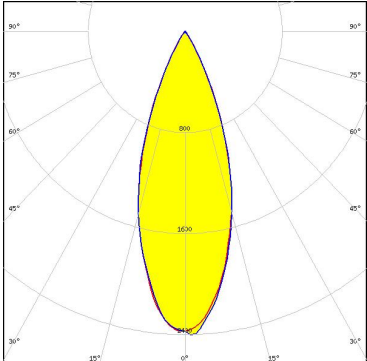
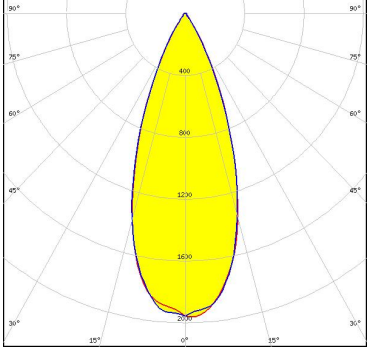

OPTICAL RESULTS (SIMULATED):

<p>CREE LEDs</p> <p>LED: XP-G2 FWHM / FWTM: 36.0° / 60.0° Efficiency: 96 % Peak intensity: 2.4 cd/lm LEDs/each optic: 1 Light colour: White Required components:</p>	
<p>CREE LEDs</p> <p>LED: XP-G3 FWHM / FWTM: 40.0° / 64.0° Efficiency: 95 % Peak intensity: 2 cd/lm LEDs/each optic: 1 Light colour: White Required components:</p>	
<p>LUMILEDS</p> <p>LED: LUXEON A FWHM / FWTM: 35.0° Efficiency: % LEDs/each optic: 1 Light colour: White Required components:</p>	
<p>NICHIA</p> <p>LED: NCSxx19A FWHM / FWTM: 35.0° Efficiency: % LEDs/each optic: 1 Light colour: White Required components:</p>	

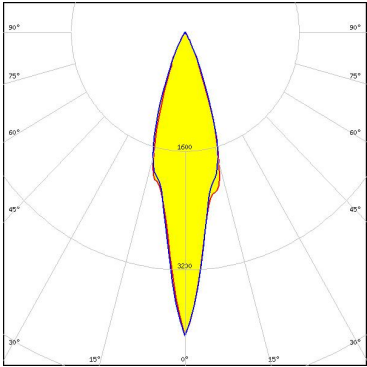
OPTICAL RESULTS (SIMULATED):

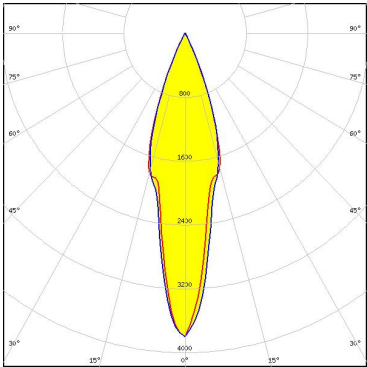
		
LED	NVSxx19A	
FWHM / FWTM	35.0°	
Efficiency	%	
LEDs/each optic	1	
Light colour	White	
Required components:		
		
LED	OSLON SSL 150	
FWHM / FWTM	35.0°	
Efficiency	%	
Peak intensity	2.8 cd/lm	
LEDs/each optic	1	
Light colour	White	
Required components:		
		
LED	SFH 4715AS	
FWHM / FWTM	23.0° / 51.0°	
Efficiency	94 %	
Peak intensity	4.1 cd/lm	
LEDs/each optic	1	
Light colour	IR	
Required components:		
		
		
LED	SFH 4716AS	
FWHM / FWTM	25.0° / 51.0°	
Efficiency	94 %	
Peak intensity	3.8 cd/lm	
LEDs/each optic	1	
Light colour	IR	
Required components:		
		

OPTICAL RESULTS (SIMULATED):

SHARP

LED	Double Dome (GM2BB)
FWHM / FWTM	35.0°
Efficiency	%
LEDs/each optic	1
Light colour	White
Required components:	