

SATU-O

~40° + 20° oval beam optimized for CREE XT-E

SPECIFICATION:

Dimensions	Ø 21.8 mm
Height	8.9 mm
Fastening	glue, pin
ROHS compliant	yes ⓘ

MATERIALS:

Component	Type	Material	Colour	Finish
SATU-O	Multi-lens	PMMA	clear	



ORDERING INFORMATION:

Component	Qty in box	MOQ	MPQ	Box weight (kg)
C13297_SATU-O » Box size: 480 x 280 x 300 mm	2880	120	120	7.7

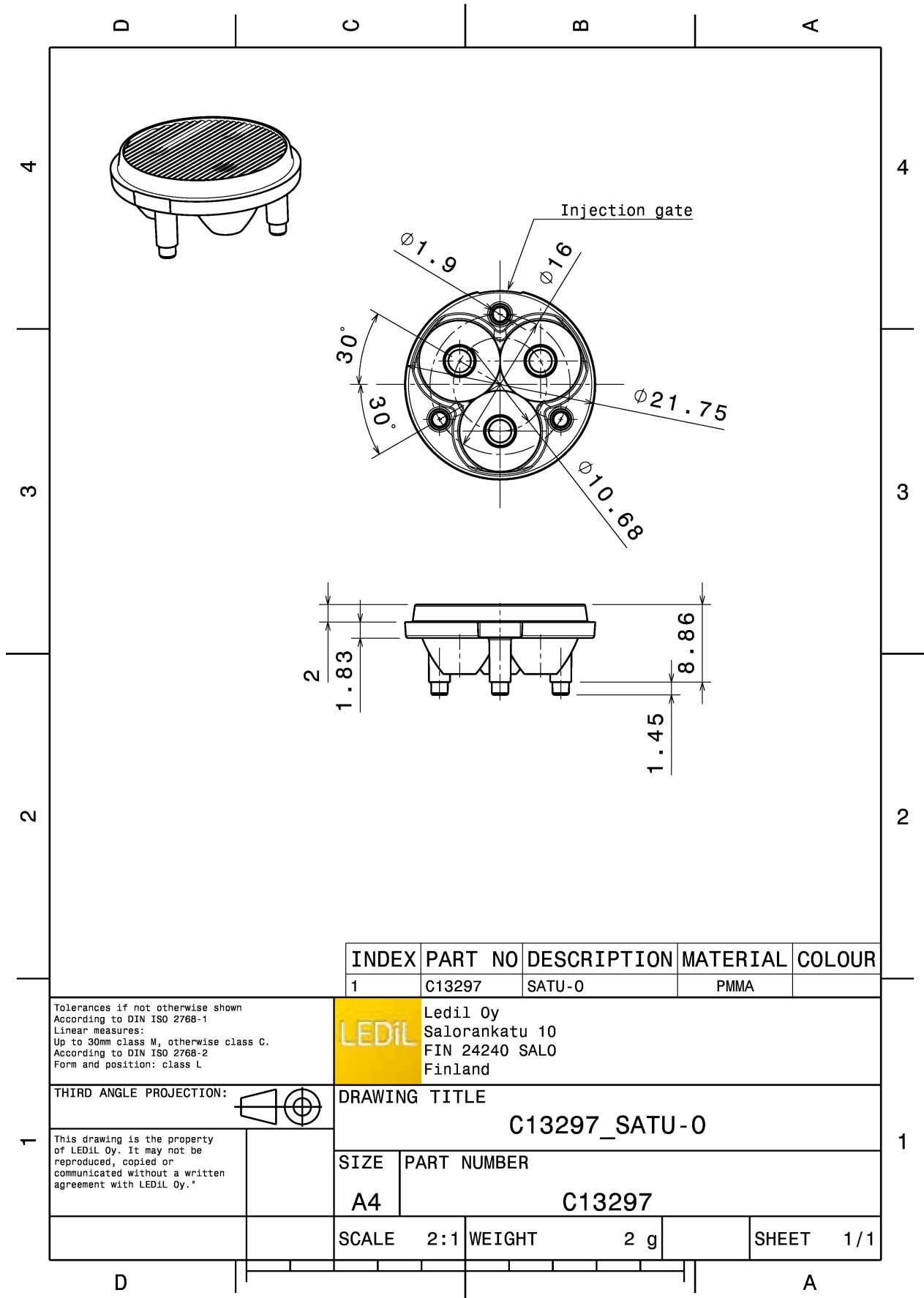

See also our general installation guide: www.ledil.com/installation_guide

OPTICAL RESULTS (MEASURED):



LED XB-D
 FWHM / FWTM 42.0 + 22.0° / 76.0 + 52.0°
 Efficiency 77 %
 Peak intensity 2 cd/lm
 LEDs/each optic 1
 Light colour White
 Required components:

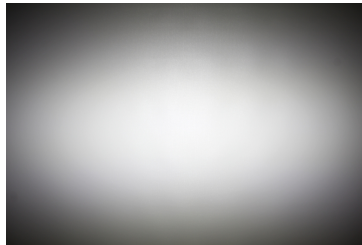

LED XP-E
 FWHM / FWTM 41.0 + 17.0° / 74.0 + 42.0°
 Efficiency 83 %
 Peak intensity 2.9 cd/lm
 LEDs/each optic 1
 Light colour White
 Required components:

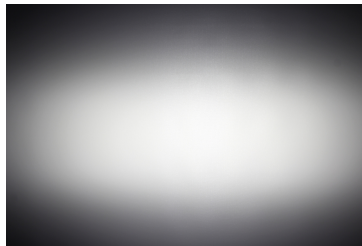

LED XP-E2
 FWHM / FWTM 40.0 + 17.0° / 71.0 + 39.0°
 Efficiency 85 %
 Peak intensity 3 cd/lm
 LEDs/each optic 1
 Light colour White
 Required components:

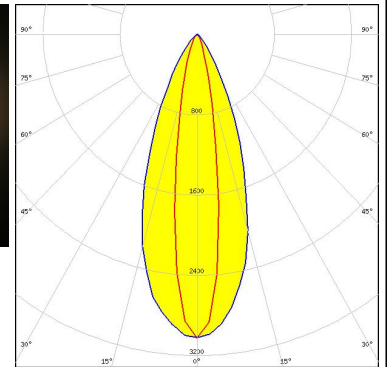

LED XP-G
 FWHM / FWTM 39.0 + 23.0° / 78.0 + 52.0°
 Efficiency 79 %
 Peak intensity 2.2 cd/lm
 LEDs/each optic 1
 Light colour White
 Required components:

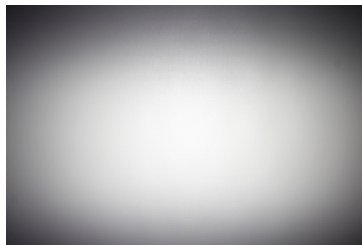

OPTICAL RESULTS (MEASURED):



LED XP-G2
FWHM / FWTM 39.0 + 24.0° / 76.0 + 52.0°
Efficiency 84 %
Peak intensity 2.2 cd/lm
LEDs/each optic 1
Light colour White
Required components:

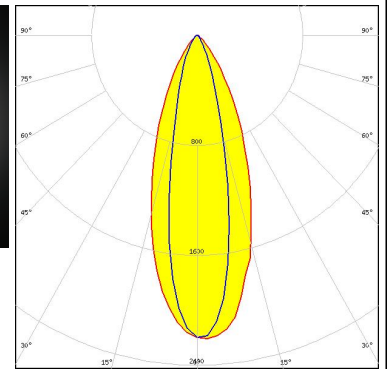
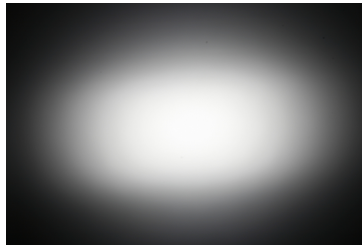

LED LUXEON T
FWHM / FWTM 40.0 + 24.0° / 79.0 + 55.0°
Efficiency 84 %
Peak intensity 2 cd/lm
LEDs/each optic 1
Light colour White
Required components:

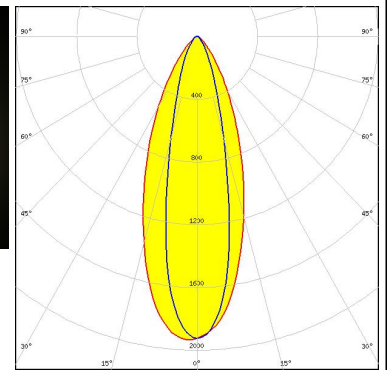
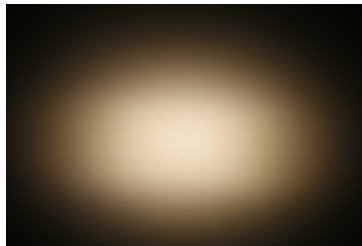

LED LUXEON TX
FWHM / FWTM 40.0 + 25.0° / 76.0 + 56.0°
Efficiency 79 %
Peak intensity 1.9 cd/lm
LEDs/each optic 1
Light colour White
Required components:

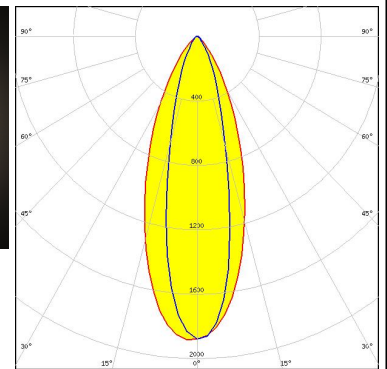
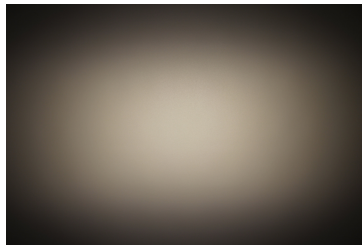

LED NF2x757A
FWHM / FWTM 43.0 + 26.0° / 84.0 + 69.0°
Efficiency 81 %
Peak intensity 1.5 cd/lm
LEDs/each optic 1
Light colour White
Required components:

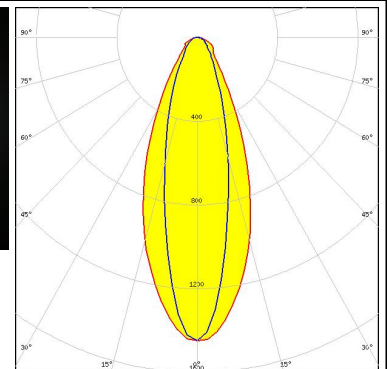
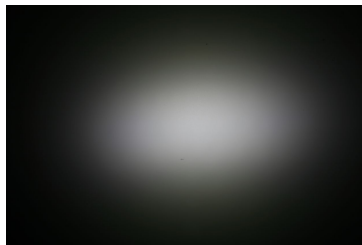

OPTICAL RESULTS (MEASURED):

OSRAM

Opto Semiconductors

LED OSLOⁿ Square EC
 FWHM / FWTM 41.0 + 23.0° / 76.0 + 51.0°
 Efficiency 82 %
 Peak intensity 2 cd/lm
 LEDs/each optic 1
 Light colour White
 Required components:

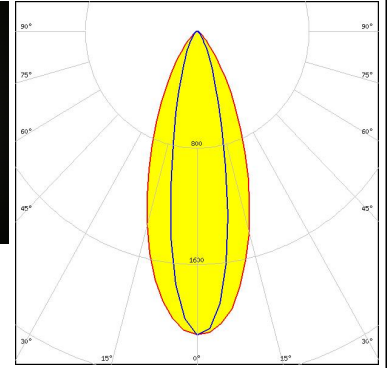

OSRAM

Opto Semiconductors

LED OSLOⁿ SSL 80
 FWHM / FWTM 41.0 + 18.0° / 74.0 + 46.0°
 Efficiency 79 %
 Peak intensity 2.5 cd/lm
 LEDs/each optic 1
 Light colour White
 Required components:



SAMSUNG

LED LH351Z
 FWHM / FWTM 40.0 + 23.0° / 76.0 + 49.0°
 Efficiency 84 %
 Peak intensity 2.3 cd/lm
 LEDs/each optic 1
 Light colour White
 Required components:

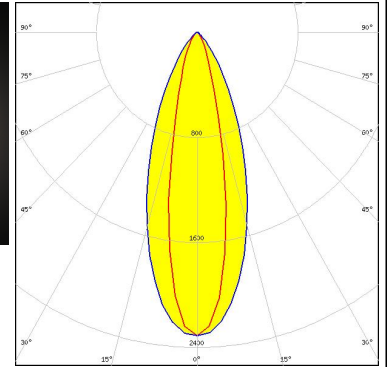
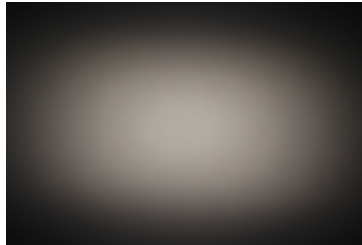

OPTICAL RESULTS (SIMULATED):



LED XT-E
 FWHM / FWTM 20.0 + 40.0°
 Efficiency %
 LEDs/each optic 1
 Light colour White
 Required components:

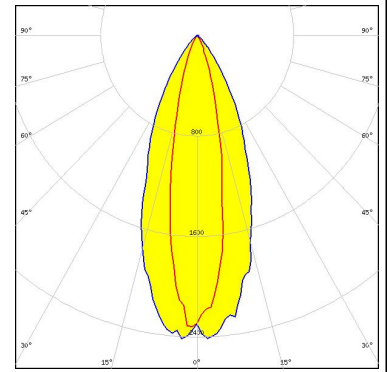

LED LUXEON H50-2
 FWHM / FWTM 22.0 + 42.0° / 51.0 + 78.0°
 Efficiency 85 %
 Peak intensity 2 cd/lm
 LEDs/each optic 1
 Light colour White
 Required components:

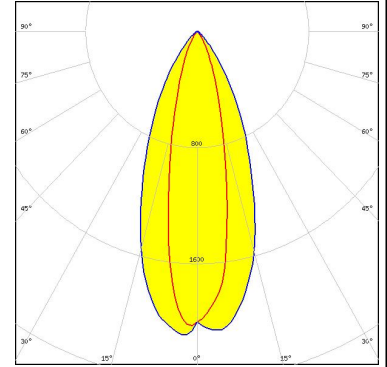

LED NVSxx19B/NVSxx19C
 FWHM / FWTM 43.0 + 24.0° / 79.0 + 54.0°
 Efficiency 82 %
 Peak intensity 2 cd/lm
 LEDs/each optic 1
 Light colour White
 Required components:

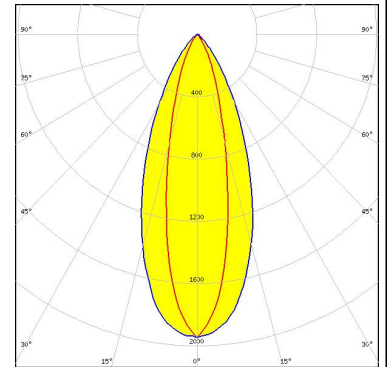

LED Synios P2720 1/2 mm
 FWHM / FWTM 25.0 + 12.0° / 69.0 + 34.0°
 Efficiency 91 %
 Peak intensity 3.5 cd/lm
 LEDs/each optic 1
 Light colour White
 Required components:

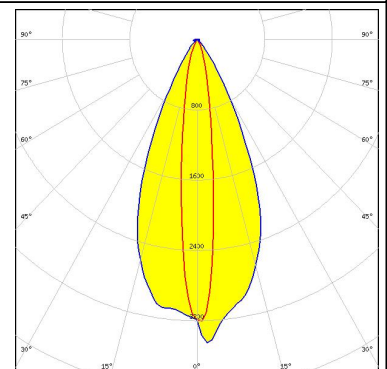

OPTICAL RESULTS (SIMULATED):

