

### SAGA-HB-IP-WHT

~60° high bay beam

#### SPECIFICATION:

Dimensions	Ø 50.0 mm
Height	12 mm
Fastening	screw
Ingress protection classes	IP67
ROHS compliant	yes ⓘ

#### MATERIALS:

Component	Type	Material	Colour	Finish
C13586_SAGA-HB-IP	Single lens	Silicone	clear	
C13591_SAGA-FRAME-WHT	Holder	HRPC	white	

#### ORDERING INFORMATION:

##### Quantities for one set:

Single lens	1
Holder	1

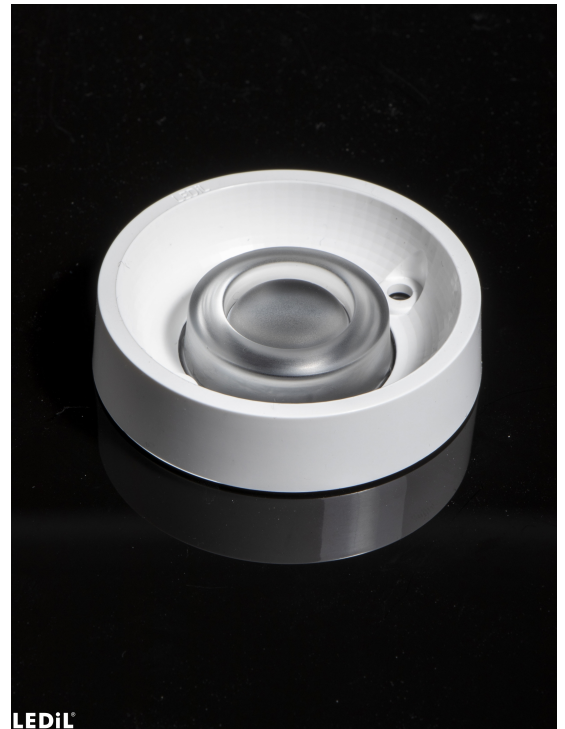



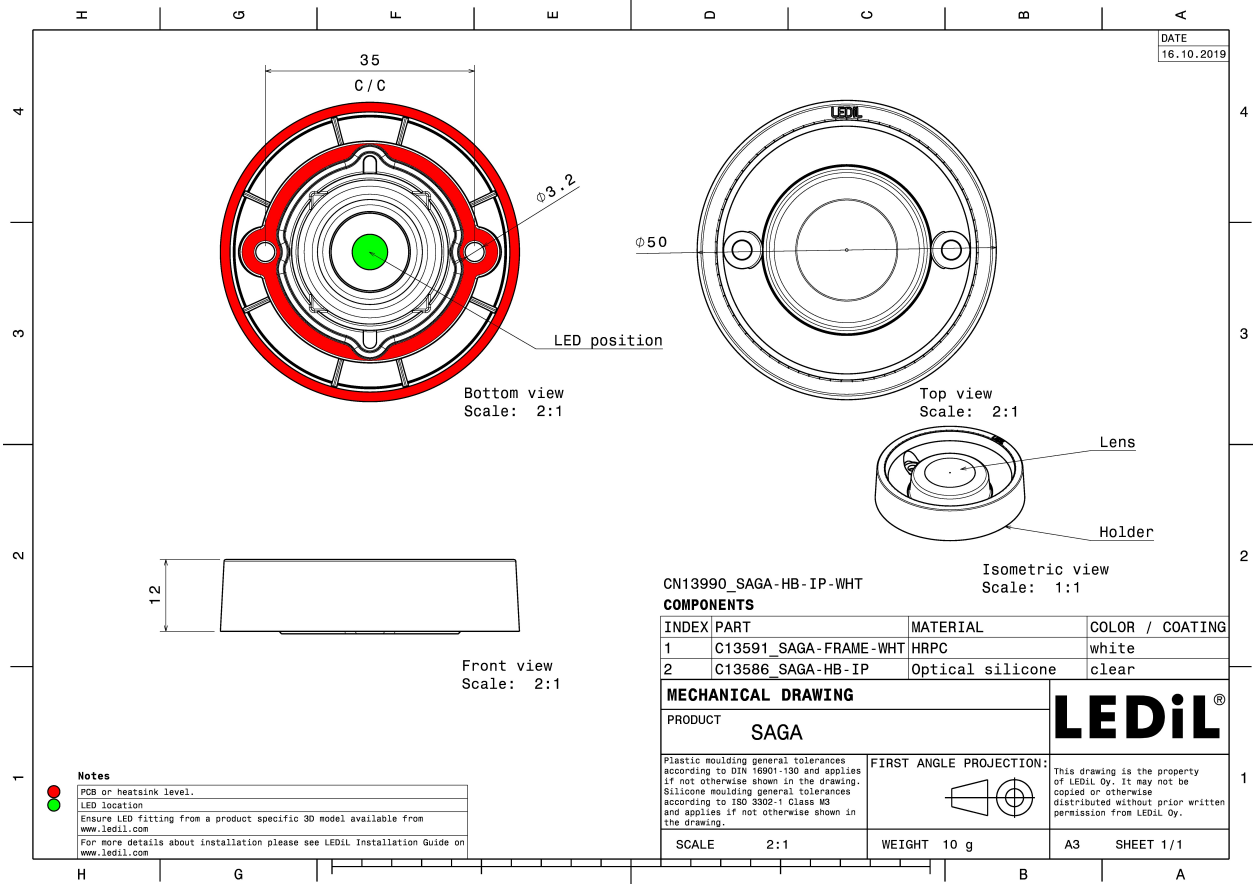



Component		Qty in box	MOQ	MPQ	Box weight (kg)
C13586_SAGA-HB-IP	Single lens	650	52	26	4.7
» Box size: 480 x 280 x 300 mm					
C13591_SAGA-FRAME-WHT	Holder	900	52	26	6.5
» Box size: 480 x 280 x 300 mm					

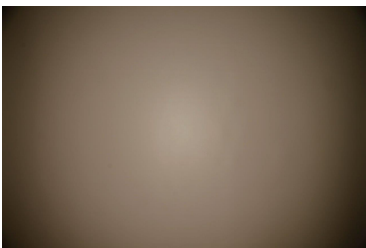
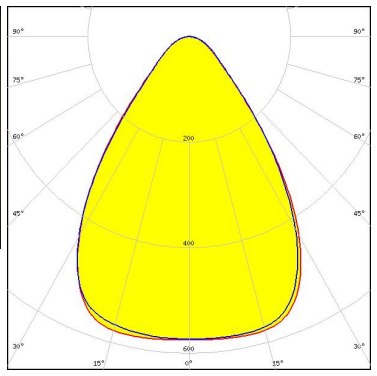

See also our general installation guide: [www.ledil.com/installation\\_guide](http://www.ledil.com/installation_guide)

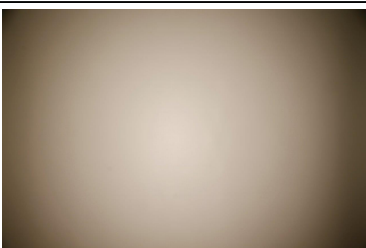
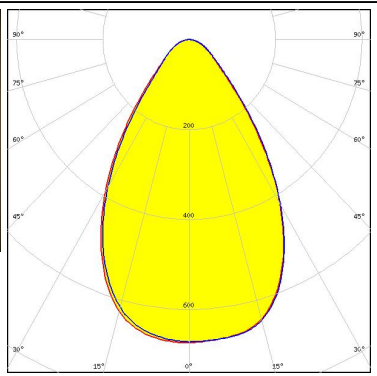
### OPTICAL RESULTS (MEASURED):

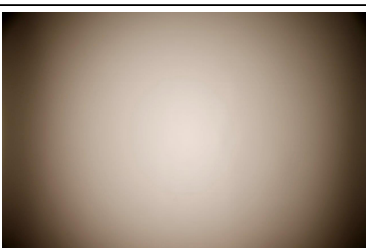
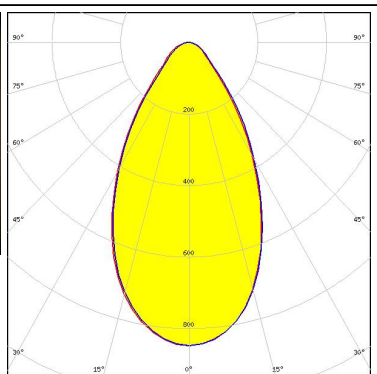
<p></p> <p>LED V10 Gen6            FWHM / FWTM 58.0° / 106.0°            Efficiency 89 %            Peak intensity 0.8 cd/lm            LEDs/each optic 1            Light colour White            Required components:</p>		
<p></p> <p>LED V6 Gen6            FWHM / FWTM 73.0° / 115.0°            Efficiency 88 %            Peak intensity 0.6 cd/lm            LEDs/each optic 1            Light colour White            Required components:</p>		
<p></p> <p>LED V8 Gen6            FWHM / FWTM 66.0° / 109.0°            Efficiency 88 %            Peak intensity 0.7 cd/lm            LEDs/each optic 1            Light colour White            Required components:</p>		
<p></p> <p>LED VERO10            FWHM / FWTM 58.0° / 101.0°            Efficiency 92 %            Peak intensity 0.9 cd/lm            LEDs/each optic 1            Light colour White            Required components:</p>		

### OPTICAL RESULTS (MEASURED):

#### CITIZEN

LED CLL01x  
 FWHM / FWTM 61.0° / 93.0°  
 Efficiency 92 %  
 Peak intensity 0.8 cd/lm  
 LEDs/each optic 1  
 Light colour White  
 Required components:

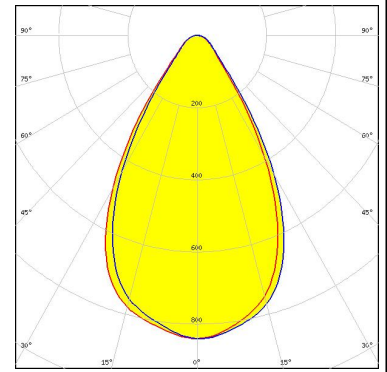

#### CITIZEN

LED CLL02x/CLU02x (LES10)  
 FWHM / FWTM 47.0° / 95.0°  
 Efficiency 86 %  
 Peak intensity 1 cd/lm  
 LEDs/each optic 1  
 Light colour White  
 Required components:  
 Bender Wirth: 434 Typ L6

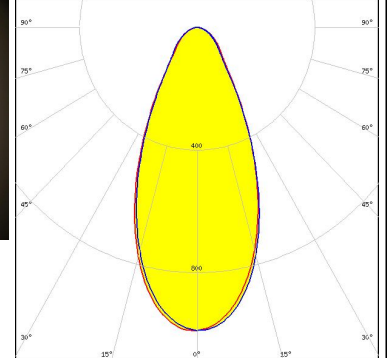
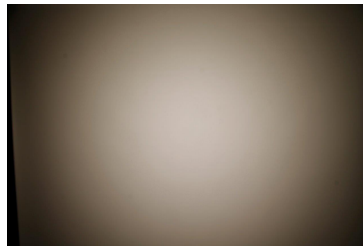

#### CITIZEN

LED CLL02x/CLU02x (LES10)  
 FWHM / FWTM 58.0° / 98.0°  
 Efficiency 91 %  
 Peak intensity 0.9 cd/lm  
 LEDs/each optic 1  
 Light colour White  
 Required components:

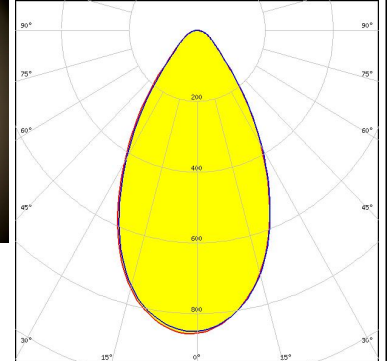
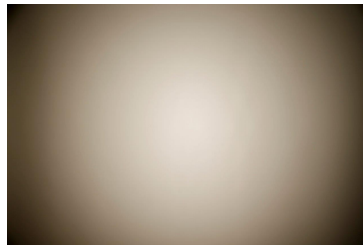

#### CITIZEN

LED CLL03x/CLU03x  
 FWHM / FWTM 61.0° / 125.0°  
 Efficiency 84 %  
 Peak intensity 0.6 cd/lm  
 LEDs/each optic 1  
 Light colour White  
 Required components:  
 Bender Wirth: 433 Typ L6

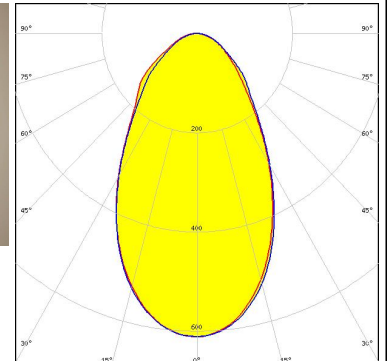

### OPTICAL RESULTS (MEASURED):

#### CITIZEN

LED CLL03x/CLU03x  
 FWHM / FWTM 64.0° / 116.0°  
 Efficiency 92 %  
 Peak intensity 0.7 cd/lm  
 LEDs/each optic 1  
 Light colour White  
 Required components:

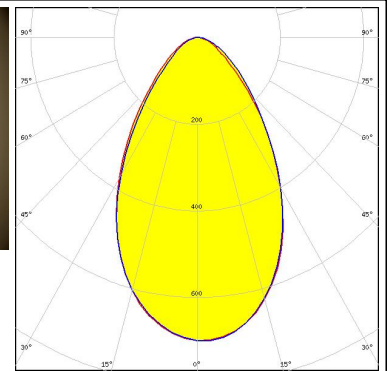
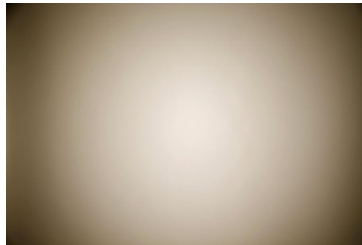

#### CITIZEN

LED CLU700/701/702/703  
 FWHM / FWTM 56.0° / 90.0°  
 Efficiency 87 %  
 Peak intensity 0.9 cd/lm  
 LEDs/each optic 1  
 Light colour White  
 Required components:

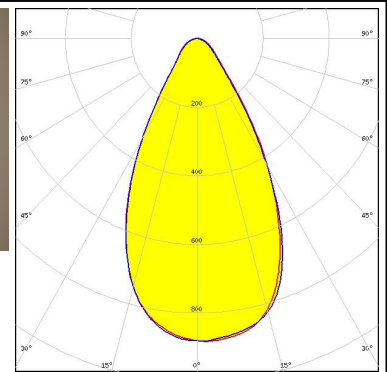
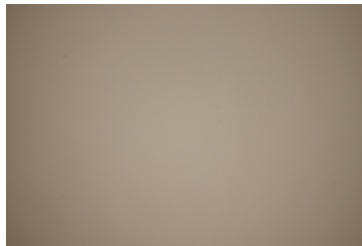

#### CITIZEN

LED CLU700/701/702/703  
 FWHM / FWTM 46.0° / 82.0°  
 Efficiency 86 %  
 Peak intensity 1.1 cd/lm  
 LEDs/each optic 1  
 Light colour White  
 Required components:  
 Bender Wirth: 434 Typ L6

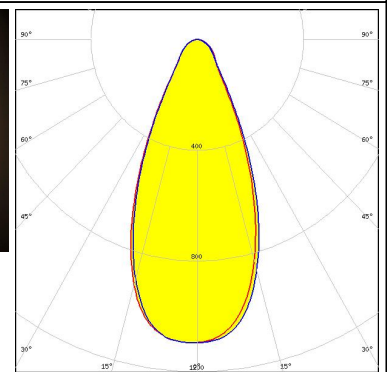
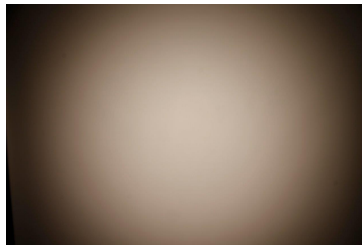

#### CITIZEN

LED CLU710/711  
 FWHM / FWTM 62.0° / 107.0°  
 Efficiency 90 %  
 Peak intensity 0.7 cd/lm  
 LEDs/each optic 1  
 Light colour White  
 Required components:

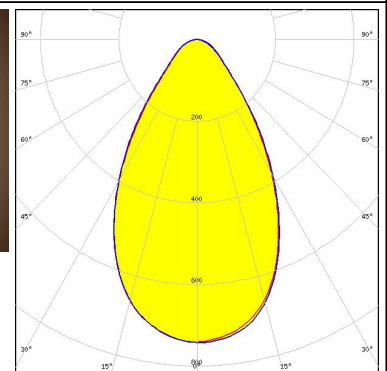
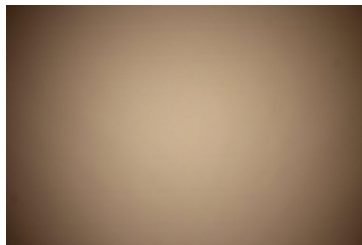

### OPTICAL RESULTS (MEASURED):

#### CITIZEN

LED CLU720/721/723  
 FWHM / FWTM 50.0° / 109.0°  
 Efficiency 85 %  
 Peak intensity 0.9 cd/lm  
 LEDs/each optic 1  
 Light colour White  
 Required components:  
 Bender Wirth: 433 Typ L6

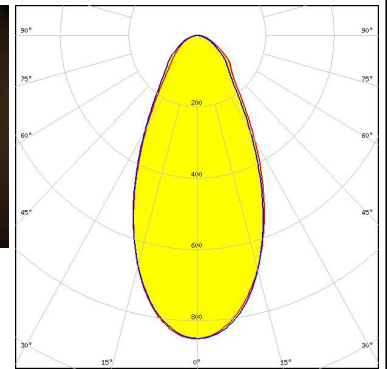
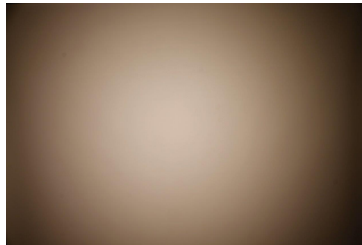

#### CITIZEN

LED CLU720/721/723  
 FWHM / FWTM 61.0° / 113.0°  
 Efficiency 89 %  
 Peak intensity 0.7 cd/lm  
 LEDs/each optic 1  
 Light colour White  
 Required components:

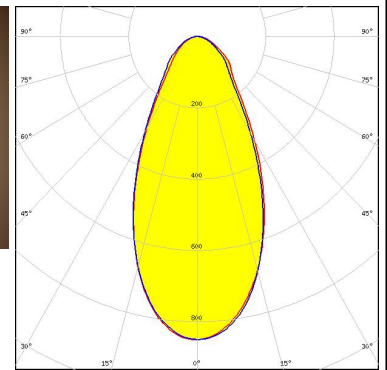
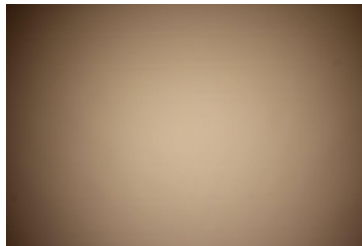

LED CXA/B 13xx  
 FWHM / FWTM 70.0° / 104.0°  
 Efficiency 92 %  
 Peak intensity 0.7 cd/lm  
 LEDs/each optic 1  
 Light colour White  
 Required components:

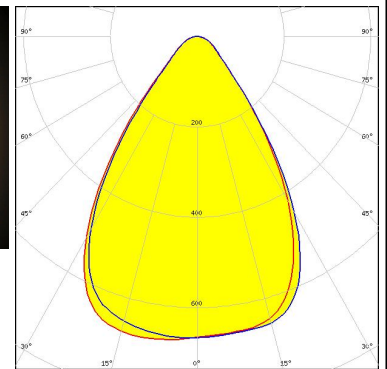
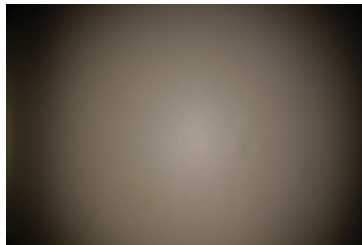

LED CXA/B 15xx  
 FWHM / FWTM 64.0° / 102.0°  
 Efficiency 90 %  
 Peak intensity 0.8 cd/lm  
 LEDs/each optic 1  
 Light colour White  
 Required components:

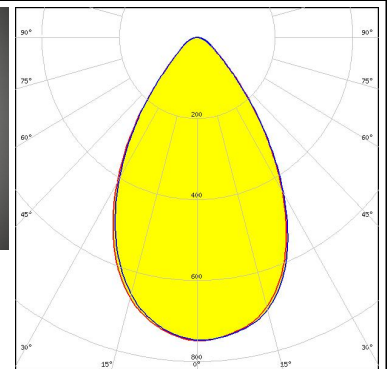
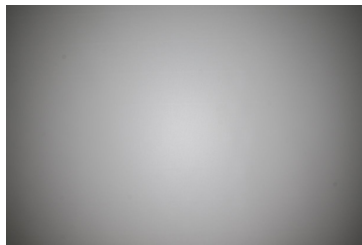



### OPTICAL RESULTS (MEASURED):



LED CXA/B 15xx  
 FWHM / FWTM 64.0° / 104.0°  
 Efficiency 92 %  
 Peak intensity 0.8 cd/m  
 LEDs/each optic 1  
 Light colour White  
 Required components:

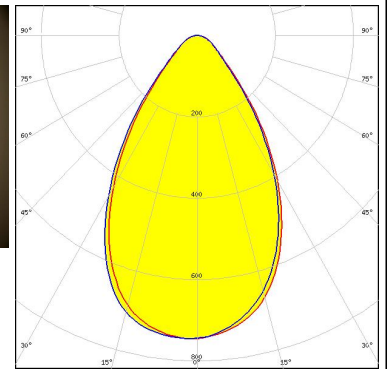
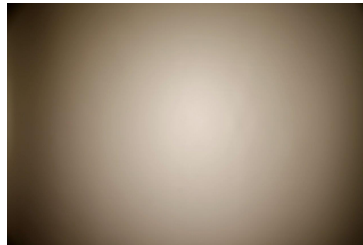

LED CXA/B 1816 & CXA/B 1820 & CXA 1850  
 FWHM / FWTM 63.0° / 111.0°  
 Efficiency 90 %  
 Peak intensity 0.7 cd/m  
 LEDs/each optic 1  
 Light colour White  
 Required components:

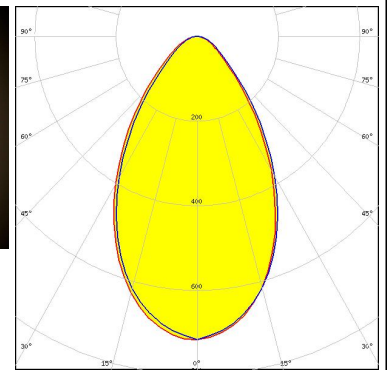
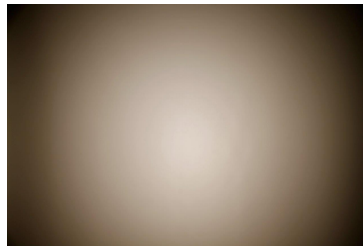

LED MHD-E/G  
 FWHM / FWTM 60.0° / 105.0°  
 Efficiency 90 %  
 Peak intensity 0.8 cd/m  
 LEDs/each optic 1  
 Light colour White  
 Required components:

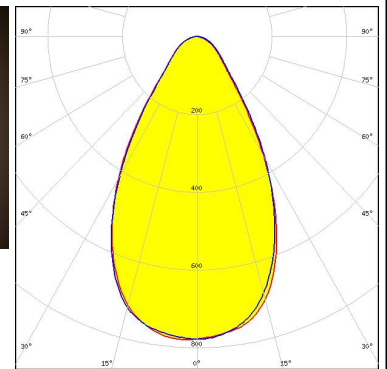
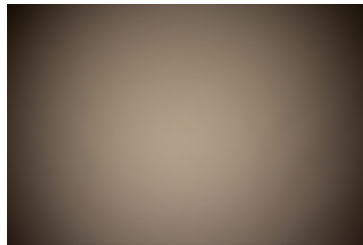

LED LUXEON CoB 1202/1203  
 FWHM / FWTM 63.0° / 108.0°  
 Efficiency 89 %  
 Peak intensity 0.7 cd/m  
 LEDs/each optic 1  
 Light colour White  
 Required components:

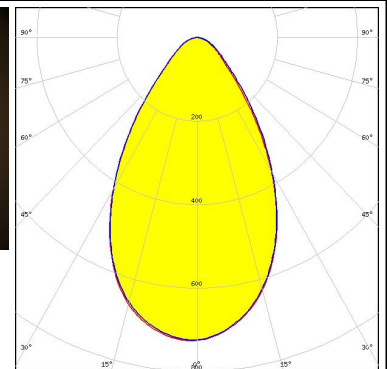
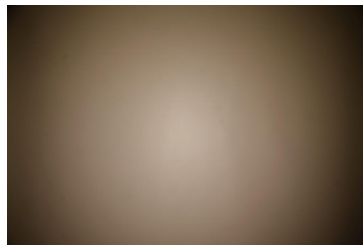



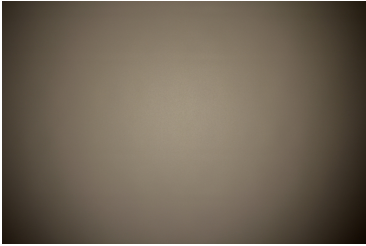
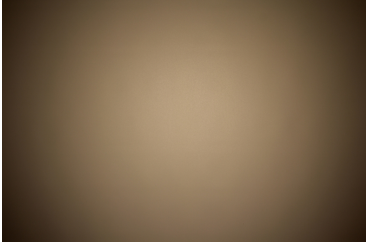
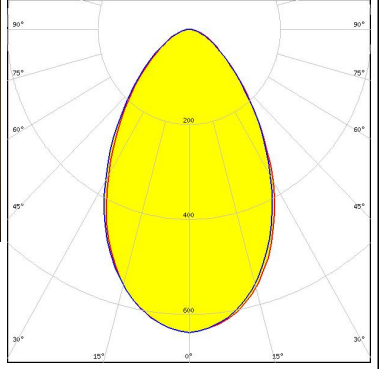
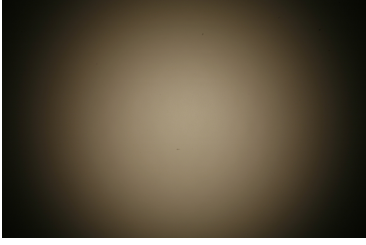
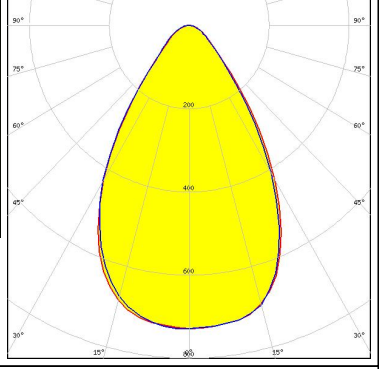
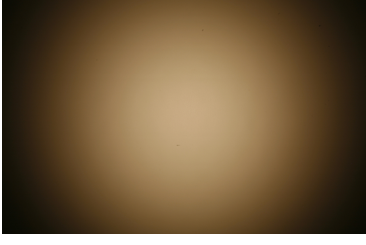
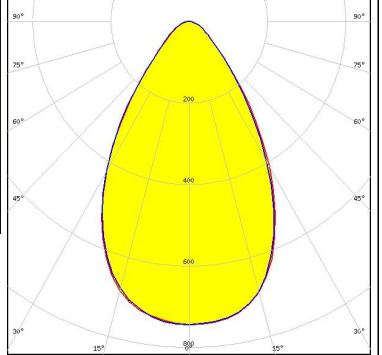

### OPTICAL RESULTS (MEASURED):

<p><b>LUMILEDS</b></p> <p>LED LUXEON CoB 1202s</p> <p>FWHM / FWTM 67.0° / 106.0°</p> <p>Efficiency 90 %</p> <p>Peak intensity 0.7 cd/lm</p> <p>LEDs/each optic 1</p> <p>Light colour White</p> <p>Required components:</p>		
<p><b>LUMINUS</b></p> <p>LED CxM-14 (19x19)</p> <p>FWHM / FWTM 66.0° / 121.0°</p> <p>Efficiency 88 %</p> <p>Peak intensity 0.6 cd/lm</p> <p>LEDs/each optic 1</p> <p>Light colour White</p> <p>Required components:</p>		
<p><b>LUMINUS</b></p> <p>LED CxM-6 (12x13)</p> <p>FWHM / FWTM 66.0° / 104.0°</p> <p>Efficiency 89 %</p> <p>Peak intensity 0.7 cd/lm</p> <p>LEDs/each optic 1</p> <p>Light colour White</p> <p>Required components:</p>		
<p><b>LUMINUS</b></p> <p>LED CXM-7 (13x13)</p> <p>FWHM / FWTM 64.0° / 105.0°</p> <p>Efficiency 89 %</p> <p>Peak intensity 0.8 cd/lm</p> <p>LEDs/each optic 1</p> <p>Light colour White</p> <p>Required components:</p>		

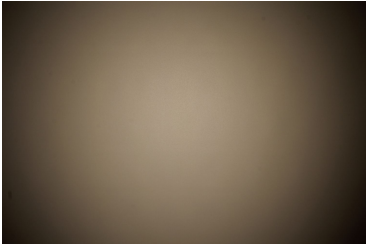
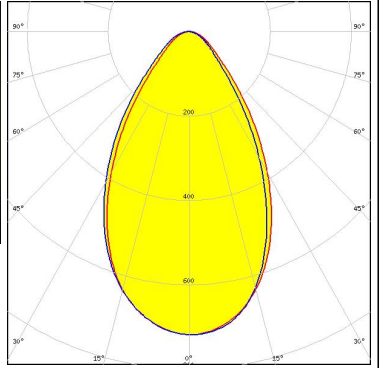
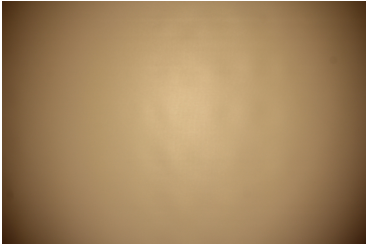
### OPTICAL RESULTS (MEASURED):

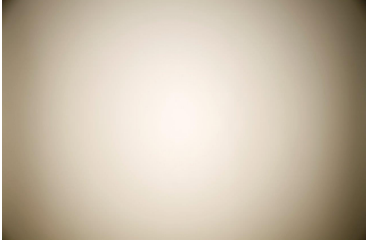
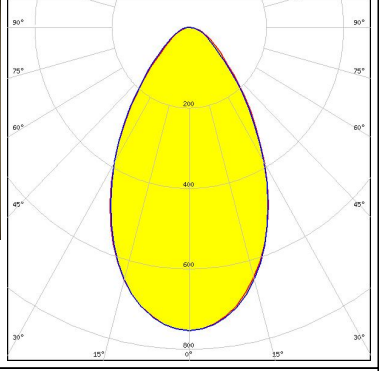
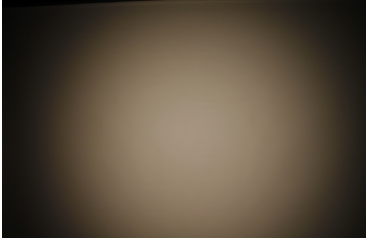
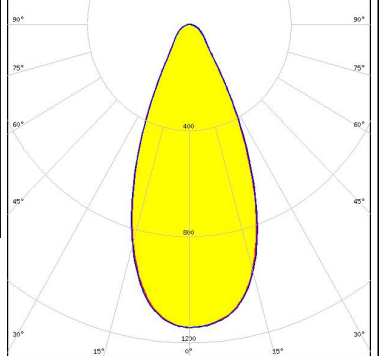
<p><b>LUMINUS</b></p> <p>LED CxM-9 (13.5x13.5)            FWHM / FWTM 63.0° / 109.0°            Efficiency 88 %            Peak intensity 0.7 cd/lm            LEDs/each optic 1            Light colour White            Required components:</p>		
<p><b>OSRAM</b> Opto Semiconductors</p> <p>LED Duris S10            FWHM / FWTM 74.0° / 106.0°            Efficiency 91 %            Peak intensity 0.7 cd/lm            LEDs/each optic 1            Light colour White            Required components:</p>		
<p><b>OSRAM</b> Opto Semiconductors</p> <p>LED Soleriq S13            FWHM / FWTM 61.0° / 110.0°            Efficiency 91 %            Peak intensity 0.8 cd/lm            LEDs/each optic 1            Light colour White            Required components:</p>		
<p><b>SEOUL SEMICONDUCTOR</b></p> <p>LED MJT COB LES 6            FWHM / FWTM 46.0° / 79.0°            Efficiency 87 %            Peak intensity 1.1 cd/lm            LEDs/each optic 1            Light colour White            Required components:            Bender Wirth: 434 Typ L6</p>		

### OPTICAL RESULTS (MEASURED):

#### SHARP

LED	Mini Zenigata (GW6BM)
FWHM / FWTM	62.0° / 100.0°
Efficiency	92 %
Peak intensity	0.8 cd/lm
LEDs/each optic	1
Light colour	White
Required components:	

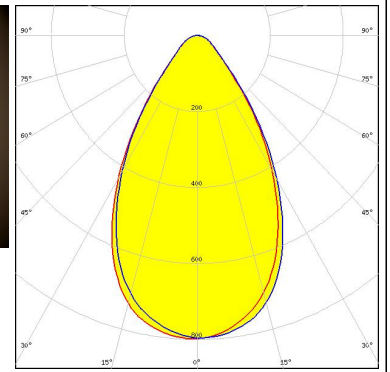
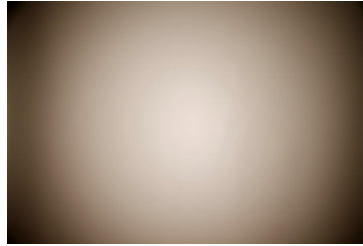

### OPTICAL RESULTS (SIMULATED):

#### LUMILEDS

LED LUXEON CoB Compact  
 FWHM / FWTM 67.0° / 106.0°  
 Efficiency 90 %  
 Peak intensity 0.7 cd/lm  
 LEDs/each optic 1  
 Light colour White  
 Required components:

#### LUMINUS

LED CxM-14 (19x19)  
 FWHM / FWTM 61.0° / 125.0°  
 Efficiency 84 %  
 Peak intensity 0.6 cd/lm  
 LEDs/each optic 1  
 Light colour White  
 Required components:  
 Bender Wirth: 433 Typ L6

#### LUMINUS

LED CxM-9 (13.5x13.5)  
 FWHM / FWTM 47.0° / 95.0°  
 Efficiency 86 %  
 Peak intensity 1 cd/lm  
 LEDs/each optic 1  
 Light colour White  
 Required components:  
 Bender Wirth: 434 Typ L6

#### NICHIA

LED COB S-Type (LES 7)  
 FWHM / FWTM 64.0° / 84.0°  
 Efficiency 95 %  
 Peak intensity 1 cd/lm  
 LEDs/each optic 1  
 Light colour White  
 Required components:

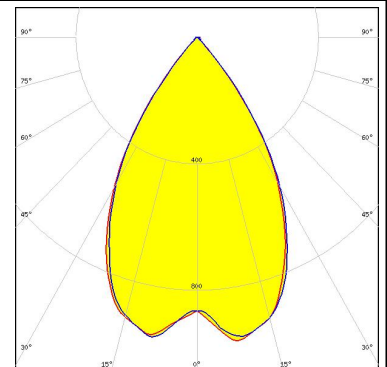

### OPTICAL RESULTS (SIMULATED):

#### OSRAM

Opto Semiconductors

LED Soleriq S9  
 FWHM / FWTM 56.0° / 87.0°  
 Efficiency 93 %  
 Peak intensity 1.1 cd/lm  
 LEDs/each optic 1  
 Light colour White  
 Required components:

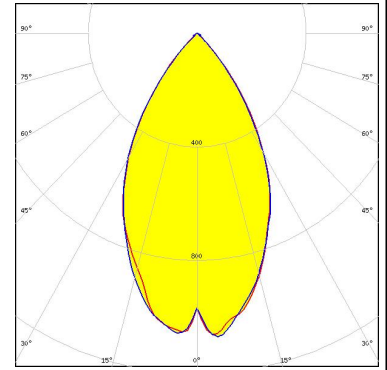

#### SAMSUNG

LED LC020C  
 FWHM / FWTM 42.0° / 66.0°  
 Efficiency 87 %  
 Peak intensity 1.6 cd/lm  
 LEDs/each optic 1  
 Light colour White  
 Required components:  
 Bender Wirth: 479 Typ L6

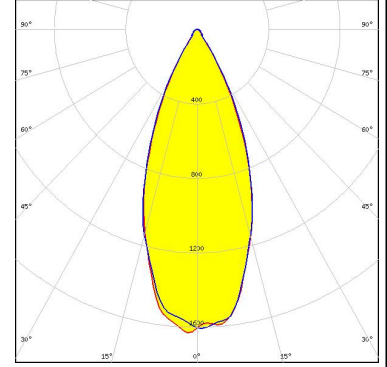

#### SAMSUNG

LED LC040C  
 FWHM / FWTM 51.0° / 81.0°  
 Efficiency 87 %  
 Peak intensity 1.1 cd/lm  
 LEDs/each optic 1  
 Light colour White  
 Required components:  
 Bender Wirth: 480 Typ L6

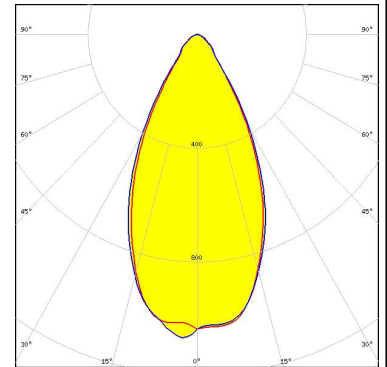

SEOUL SEMICONDUCTOR

LED ZC12/18  
 FWHM / FWTM 61.0° / 125.0°  
 Efficiency 84 %  
 Peak intensity 0.6 cd/lm  
 LEDs/each optic 1  
 Light colour White  
 Required components:  
 Bender Wirth: 433 Typ L6

## OPTICAL RESULTS (SIMULATED):

 SEOUL SEMICONDUCTOR	
LED	ZC4/6
FWHM / FWTM	47.0° / 95.0°
Efficiency	86 %
Peak intensity	1 cd/lm
LEDs/each optic	1
Light colour	White
Required components:	
Bender Wirth: 434 Typ L6	