

MOLLY-M

~35° medium beam

SPECIFICATION:

Dimensions	Ø 69.8 mm
Height	23.6 mm
ROHS compliant	yes ⓘ

MATERIALS:

Component	Type	Material	Colour	Finish
MOLLY-M	Single lens	PMMA	clear	

ORDERING INFORMATION:





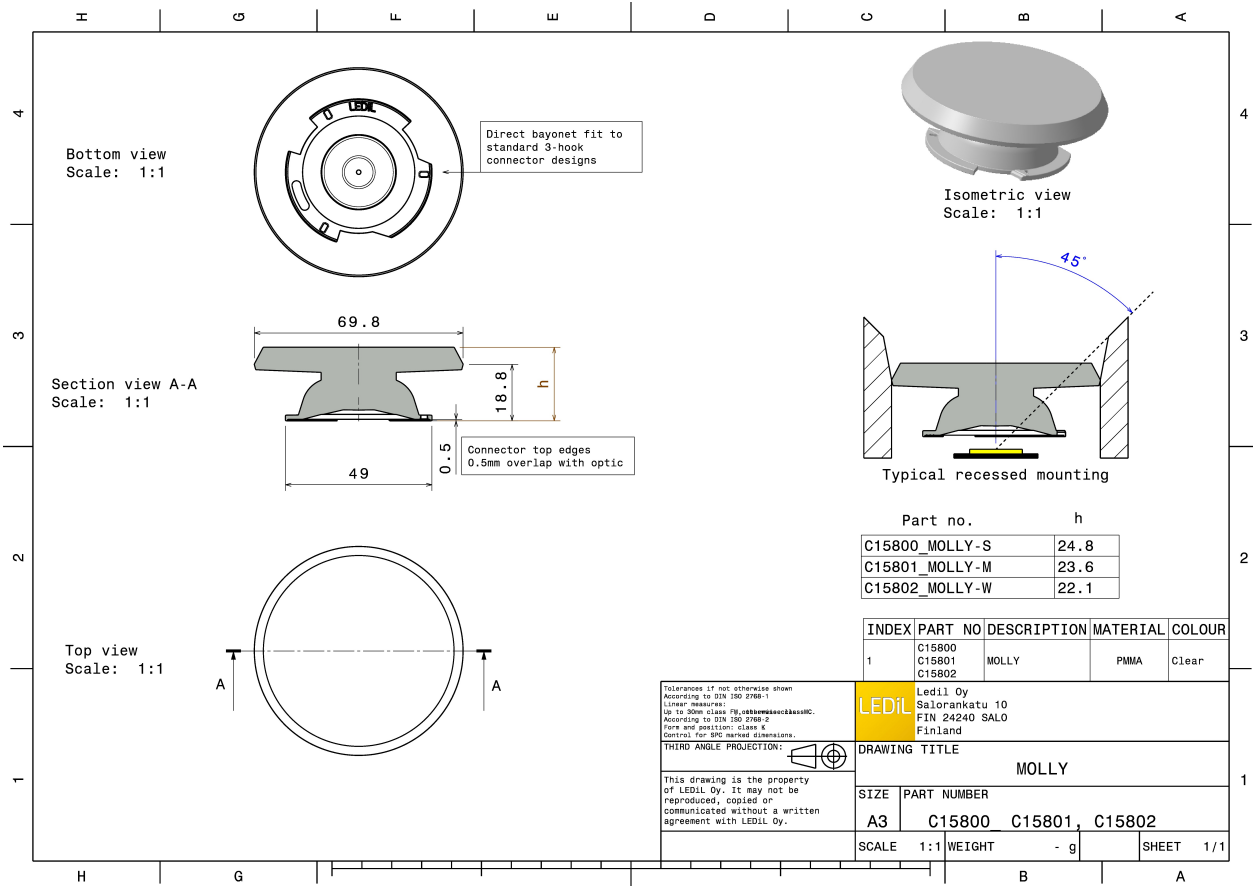



Component	Qty in box	MOQ	MPQ	Box weight (kg)
C15801_MOLLY-M » Box size: 476 x 273 x 292 mm	198	36	18	9.0



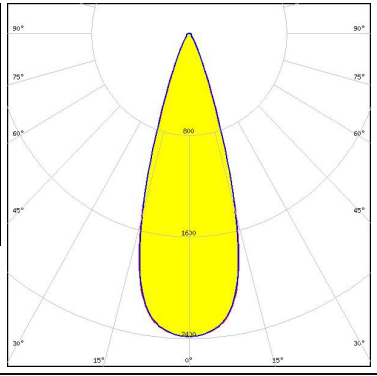

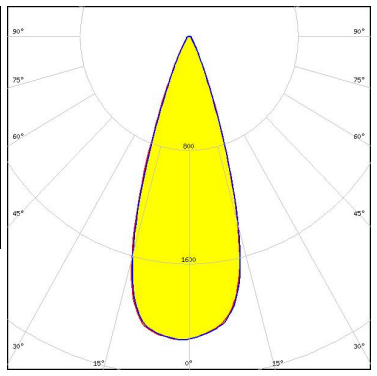

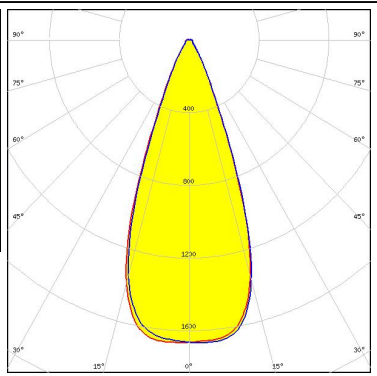

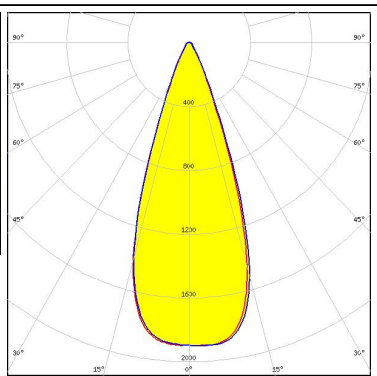

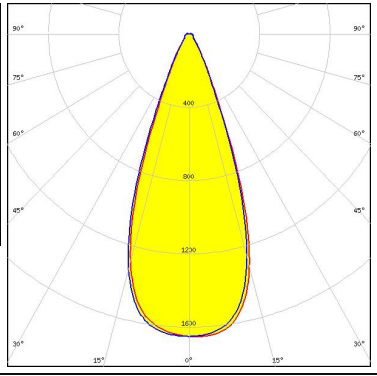

See also our general installation guide: www.ledil.com/installation_guide

OPTICAL RESULTS (MEASURED):

<p></p> <p>LED V11 HD Gen 8</p> <p>FWHM / FWTM 33.0° / 52.0°</p> <p>Efficiency 90 %</p> <p>Peak intensity 2.4 cd/lm</p> <p>LEDs/each optic 1</p> <p>Light colour White</p> <p>Required components: Bender Wirth: 633d 3Hook</p>		
<p></p> <p>LED Vero SE 13</p> <p>FWHM / FWTM 36.0° / 54.0°</p> <p>Efficiency 90 %</p> <p>Peak intensity 2.1 cd/lm</p> <p>LEDs/each optic 1</p> <p>Light colour White</p> <p>Required components: C16402_CLAMP-VEROSE-13-18</p>		
<p></p> <p>LED Vero SE 18</p> <p>FWHM / FWTM 40.0° / 62.0°</p> <p>Efficiency 89 %</p> <p>Peak intensity 1.7 cd/lm</p> <p>LEDs/each optic 1</p> <p>Light colour White</p> <p>Required components: C16402_CLAMP-VEROSE-13-18</p>		
<p></p> <p>LED Vesta TW 15mm DP</p> <p>FWHM / FWTM 38.0° / 58.0°</p> <p>Efficiency 90 %</p> <p>Peak intensity 1.9 cd/lm</p> <p>LEDs/each optic 1</p> <p>Light colour Tunable White</p> <p>Required components: C13658_CLAMP-VERO13-18 Bender Wirth: 482 Typ L2</p>		

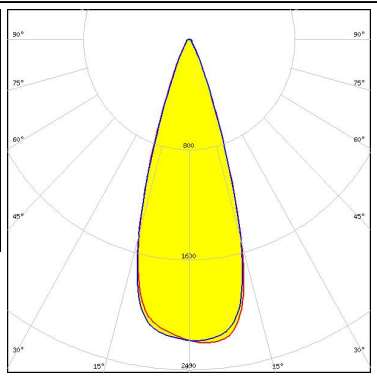
OPTICAL RESULTS (MEASURED):

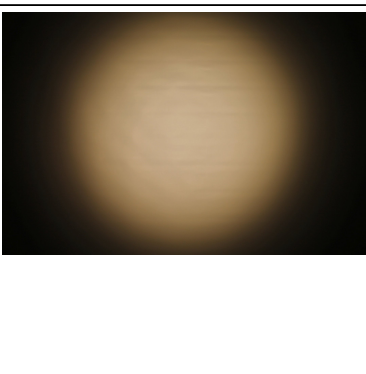
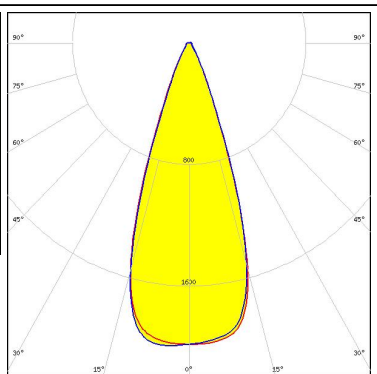
<p></p> <p>LED Vesta TW 18mm (31W) DP FWHM / FWTM 40.0° / 61.0° Efficiency 88 % Peak intensity 1.7 cd/lm LEDs/each optic 1 Light colour Tunable White</p> <p>Required components: C13584_CLAMP-VERO29 Bender Wirth: 483 Typ L3</p>		
<p>CITIZEN</p> <p>LED CLL03x/CLU03x FWHM / FWTM 36.0° / 55.0° Efficiency 89 % Peak intensity 2.1 cd/lm LEDs/each optic 1 Light colour White</p> <p>Required components: Bender Wirth: 433 Typ L1</p>		
<p>CITIZEN</p> <p>LED LCN-C02B (Tunable White) FWHM / FWTM 35.0° / 53.0° Efficiency 89 % Peak intensity 2.2 cd/lm LEDs/each optic 1 Light colour White</p> <p>Required components: C13658_CLAMP-VERO13-18 Bender Wirth: 481 Typ L2</p>		
<p></p> <p>LED CMA1840 FWHM / FWTM 37.0° / 56.0° Efficiency 91 % Peak intensity 2 cd/lm LEDs/each optic 1 Light colour White</p> <p>Required components: C14123_CLAMP-CXA15-18</p>		

OPTICAL RESULTS (MEASURED):



LED CMA2550
 FWHM / FWTM 42.0° / 62.0°
 Efficiency 89 %
 Peak intensity 1.6 cd/lm
 LEDs/each optic 1
 Light colour White
 Required components:
 C14036_CLAMP_CXA25-30

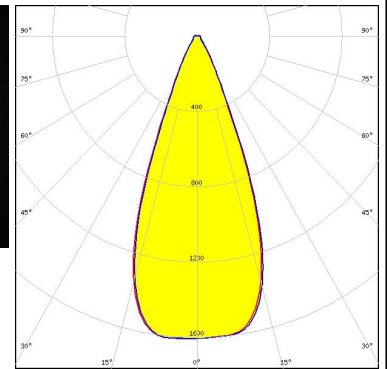
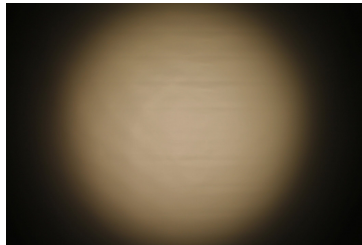

LED CMA3090
 FWHM / FWTM 45.0° / 68.0°
 Efficiency 88 %
 Peak intensity 1.4 cd/lm
 LEDs/each optic 1
 Light colour White
 Required components:
 C14036_CLAMP_CXA25-30

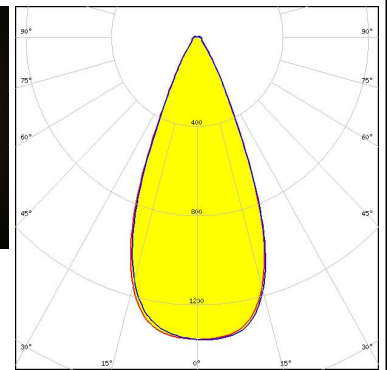
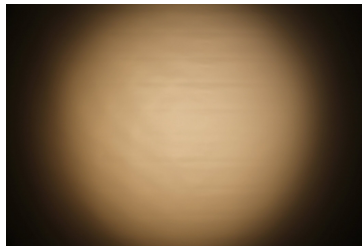

LED CMT14xx
 FWHM / FWTM 33.0° / 50.0°
 Efficiency 90 %
 Peak intensity 2.5 cd/lm
 LEDs/each optic 1
 Light colour White
 Required components:
 C13658_CLAMP-VERO13-18
 Bender Wirth: 434 Typ L1

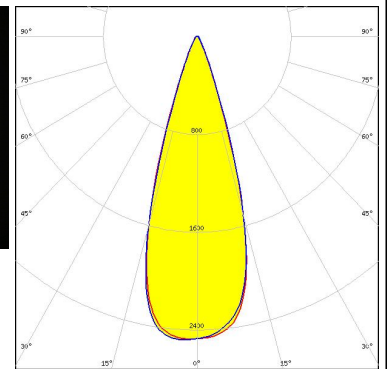

LED CMT19xx
 FWHM / FWTM 36.0° / 55.0°
 Efficiency 90 %
 Peak intensity 2.1 cd/lm
 LEDs/each optic 1
 Light colour White
 Required components:
 C13658_CLAMP-VERO13-18
 Bender Wirth: 477 Typ L1

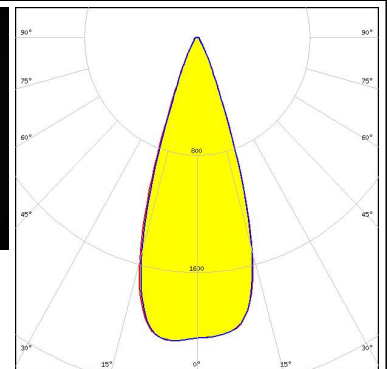
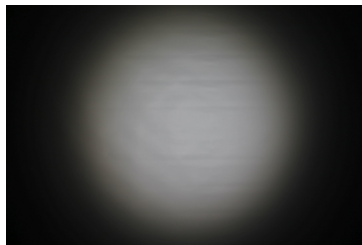

OPTICAL RESULTS (MEASURED):



LED CMT28xx
 FWHM / FWTM 42.0° / 65.0°
 Efficiency 87 %
 Peak intensity 1.5 cd/lm
 LEDs/each optic 1
 Light colour White
 Required components:
 C13584_CLAMP-VERO29
 Bender Wirth: 471 Typ L3

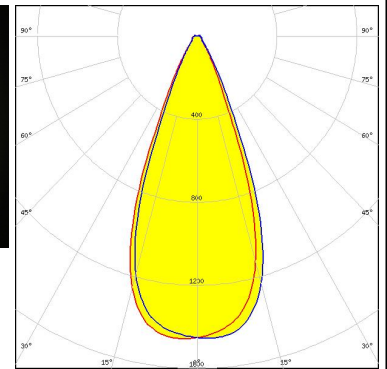

LED CXA/B 15xx
 FWHM / FWTM 34.0° / 51.0°
 Efficiency 90 %
 Peak intensity 2.4 cd/lm
 LEDs/each optic 1
 Light colour White
 Required components:
 C14123_CLAMP-CXA15-18

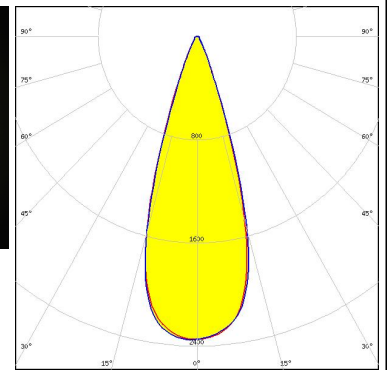

LED LUXEON CoB 1204HD
 FWHM / FWTM 30.0° / 46.0°
 Efficiency 89 %
 Peak intensity 2.9 cd/lm
 LEDs/each optic 1
 Light colour White
 Required components:
 TE Connectivity: 2213382-2 + OPTIC CLIP Z50 TYPE1 2213194-1

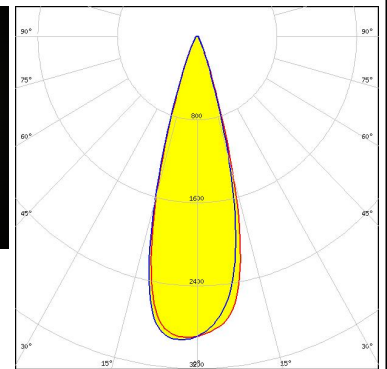
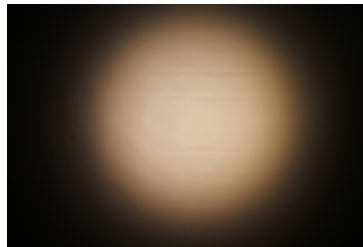

LED CDM-14 (Dim-To-Warm)
 FWHM / FWTM 36.0° / 54.0°
 Efficiency 89 %
 Peak intensity 2 cd/lm
 LEDs/each optic 1
 Light colour White
 Required components:
 C13658_CLAMP-VERO13-18
 Bender Wirth: 491 Typ L2

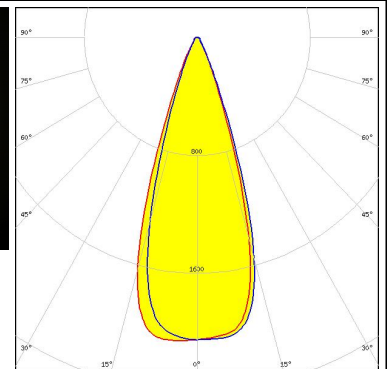
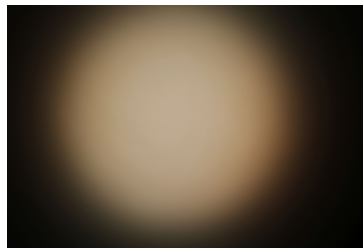

OPTICAL RESULTS (MEASURED):

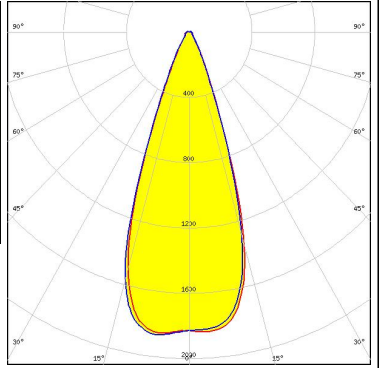
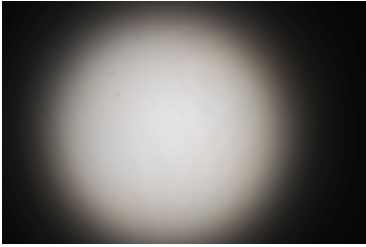
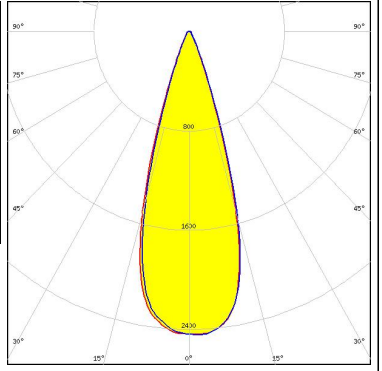
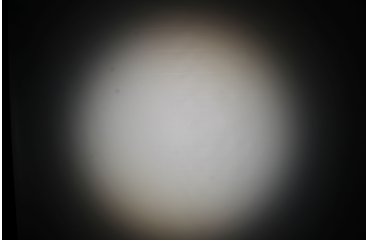
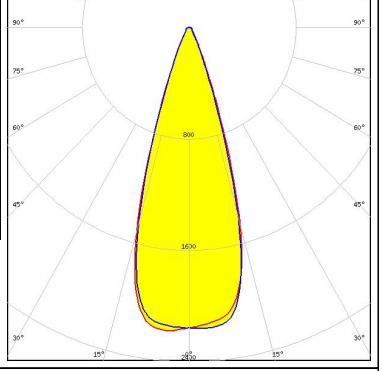
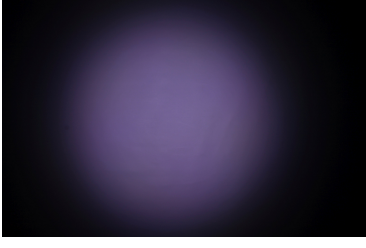
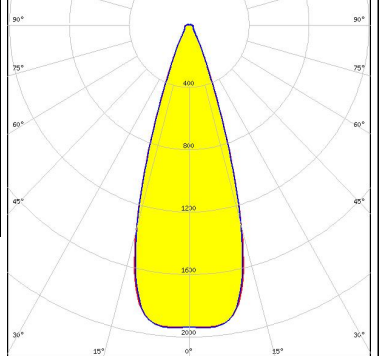
<p>LUMINUS</p> <p>LED CDM-18 (Dim-To-Warm)</p> <p>FWHM / FWTM 38.0° / 57.0°</p> <p>Efficiency 89 %</p> <p>Peak intensity 1.9 cd/lm</p> <p>LEDs/each optic 1</p> <p>Light colour White</p> <p>Required components: C13658_CLAMP-VERO13-18 Bender Wirth: 491 Typ L2</p>		
<p>LUMINUS</p> <p>LED CDM-9 (Dim-To-Warm)</p> <p>FWHM / FWTM 33.0° / 49.0°</p> <p>Efficiency 89 %</p> <p>Peak intensity 2.4 cd/lm</p> <p>LEDs/each optic 1</p> <p>Light colour White</p> <p>Required components: C13658_CLAMP-VERO13-18 Bender Wirth: 490 Typ L1</p>		
<p>LUMINUS</p> <p>LED CTM-14 (Tunable White)</p> <p>FWHM / FWTM 34.0° / 52.0°</p> <p>Efficiency 88 %</p> <p>Peak intensity 2.2 cd/lm</p> <p>LEDs/each optic 1</p> <p>Light colour White</p> <p>Required components: C13584_CLAMP-VERO29 Bender Wirth: 442 Typ L3</p>		
<p>LUMINUS</p> <p>LED CTM-14 RGBW</p> <p>FWHM / FWTM 35.0° / 55.0°</p> <p>Efficiency 88 %</p> <p>Peak intensity 2 cd/lm</p> <p>LEDs/each optic 1</p> <p>Light colour RGBW</p> <p>Required components: C13584_CLAMP-VERO29 Bender Wirth: 500 Typ L3-1</p>		

OPTICAL RESULTS (MEASURED):



LED CTM-22 (Tunable White)
 FWHM / FWTM 42.0° / 64.0°
 Efficiency 87 %
 Peak intensity 1.5 cd/m
 LEDs/each optic 1
 Light colour White
 Required components:
 C13584_CLAMP-VERO29
 Bender Wirth: 494 Typ L3

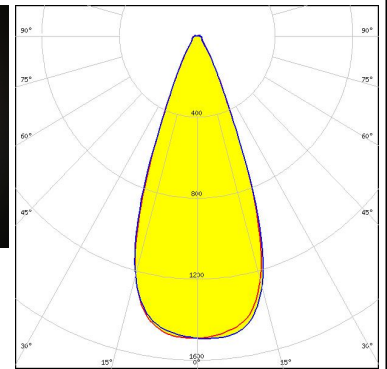
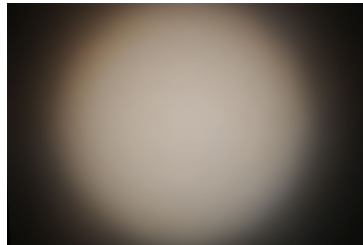

LED NVCWJ024Z-V1MT: COB J-Type Tunable White
 FWHM / FWTM 33.0° / 51.0°
 Efficiency 89 %
 Peak intensity 2.4 cd/m
 LEDs/each optic 1
 Light colour White
 Required components:
 C13658_CLAMP-VERO13-18
 Bender Wirth: 498 Typ L2

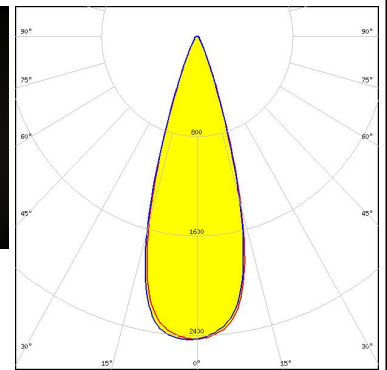
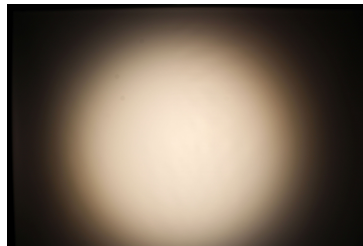

LED PrevaLED Core G7 L15 H1
 FWHM / FWTM 35.0° / 55.0°
 Efficiency 90 %
 Peak intensity 2.1 cd/m
 LEDs/each optic 1
 Light colour White
 Required components:
 C16685_CLAMP-PRV-A

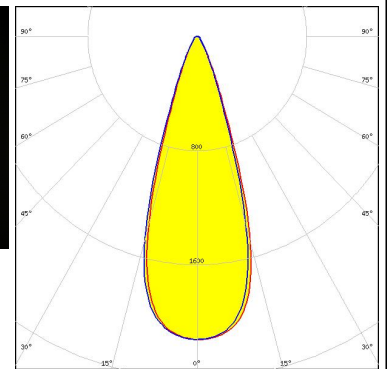
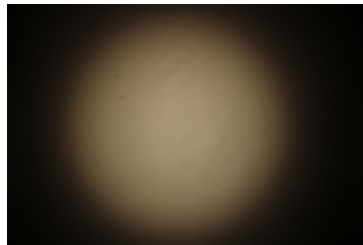

LED Fortimo SLM L13 CoB
 FWHM / FWTM 35.0° / 53.0°
 Efficiency 89 %
 Peak intensity 2.2 cd/m
 LEDs/each optic 1
 Light colour White
 Required components:
 TE Connectivity: 2213130-2 + OPTIC CLIP Z50 TYPE1 2213194-1

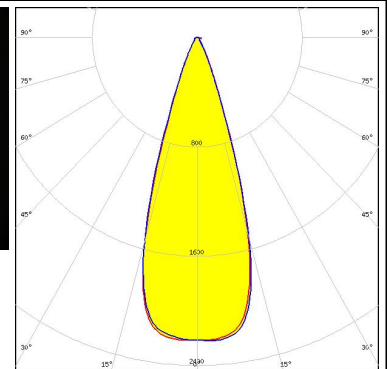
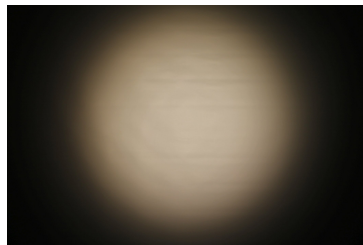

OPTICAL RESULTS (MEASURED):

PHILIPS

LED Fortimo SLM L15 + SLM holder
 FWHM / FWTM 34.0° / 53.0°
 Efficiency 89 %
 Peak intensity 2.3 cd/lm
 LEDs/each optic 1
 Light colour White

Required components:

TE Connectivity: OPTIC CLIP Z50 TYPE1 2213194-1

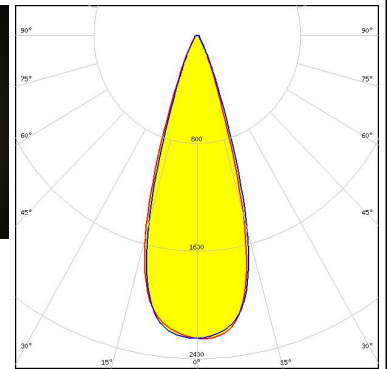
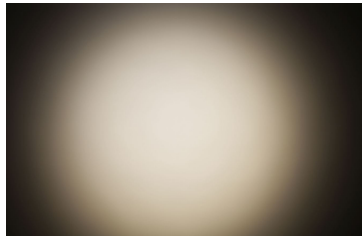

PHILIPS

LED Fortimo SLM L15 CoB
 FWHM / FWTM 36.0° / 54.0°
 Efficiency 88 %
 Peak intensity 2.1 cd/lm
 LEDs/each optic 1
 Light colour White

Required components:

TE Connectivity: 2213130-2 + OPTIC CLIP Z50 TYPE1 2213194-1

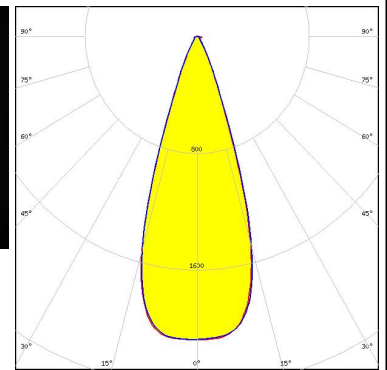
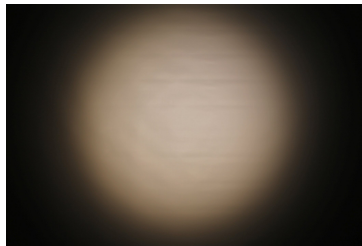

SAMSUNG

LED LC035T (Tunable white)
 FWHM / FWTM 43.0° / 67.0°
 Efficiency 88 %
 Peak intensity 1.4 cd/lm
 LEDs/each optic 1
 Light colour White

Required components:

C13584_CLAMP-VERO29

Bender Wirth: 502 Typ L3

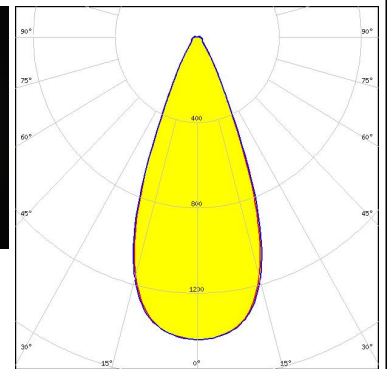
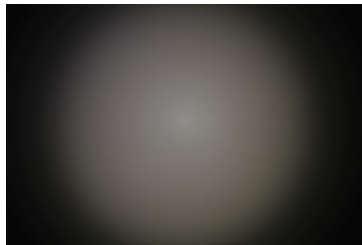

XICATO

LED XTM - 19mm LES
 FWHM / FWTM 39.0° / 60.0°
 Efficiency 90 %
 Peak intensity 1.8 cd/lm
 LEDs/each optic 1
 Light colour White

Required components:

C16491_XTM-ADAPTER-50-A

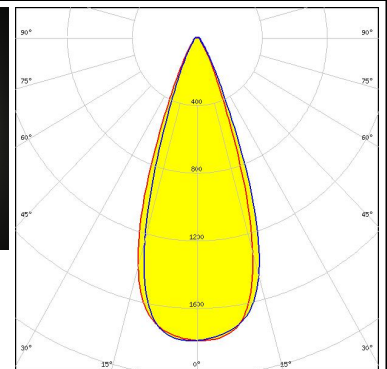
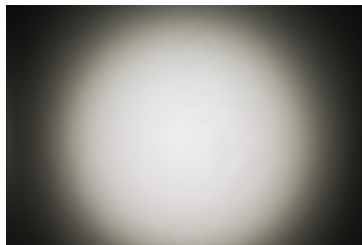

OPTICAL RESULTS (SIMULATED):

bridgelux

LED V9 HD Gen7
 FWHM / FWTM 32.0° / 44.0°
 Efficiency 90 %
 Peak intensity 3.3 cd/lm
 LEDs/each optic 1
 Light colour White
 Required components:
 C13658_CLAMP-VERO13-18
 Bender Wirth: 496 Typ L1

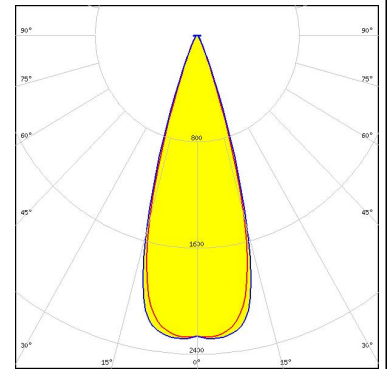

bridgelux

LED VERO13
 FWHM / FWTM 32.0° / 46.0°
 Efficiency 91 %
 Peak intensity 3.1 cd/lm
 LEDs/each optic 1
 Light colour White
 Required components:
 C13658_CLAMP-VERO13-18

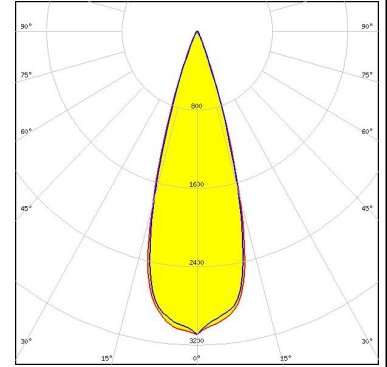

CITIZEN

LED CLL02x/CLU02x (LES10)
 FWHM / FWTM 30.0° / 42.0°
 Efficiency 89 %
 Peak intensity 3.6 cd/lm
 LEDs/each optic 1
 Light colour White
 Required components:
 Bender Wirth: 434 Typ L1

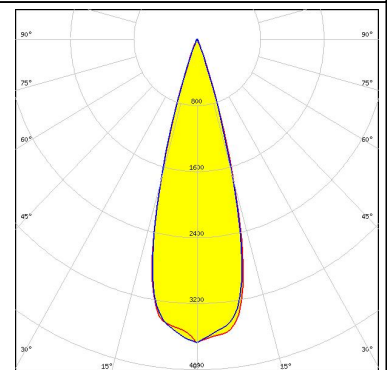

CREE
LEDs

LED CXA/B 1816 & CXA/B 1820 & CXA 1850
 FWHM / FWTM 33.0° / 47.0°
 Efficiency 90 %
 Peak intensity 3.1 cd/lm
 LEDs/each optic 1
 Light colour White
 Required components:
 C14123_CLAMP-CXA15-18

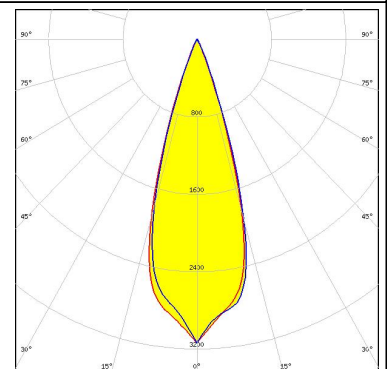

OPTICAL RESULTS (SIMULATED):



LED CXA/B 25xx
FWHM / FWTM 36.0° / 50.0°
Efficiency 88 %
Peak intensity 2.2 cd/lm
LEDs/each optic 1
Light colour White
Required components:
C14036_CLAMP_CXA25-30

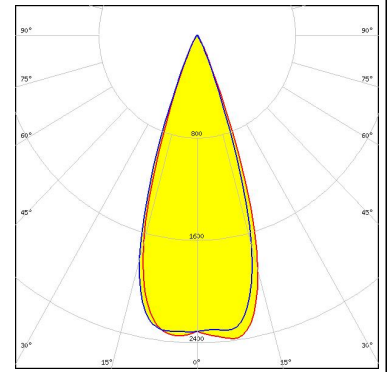

LED CTM-18 (Tunable White)
FWHM / FWTM 34.0° / 47.0°
Efficiency 80 %
Peak intensity 2.3 cd/lm
LEDs/each optic 1
Light colour White
Required components:
C13658_CLAMP-VERO13-18

