

MOLLY-W

~60° wide beam

TECHNICAL SPECIFICATIONS:

Dimensions	Ø 69.8 mm
Height	22.1 mm
ROHS compliant	yes ⓘ

MATERIAL SPECIFICATIONS:

Component	Type	Material	Colour	Finish
MOLLY-W	Single lens	PMMA	clear	







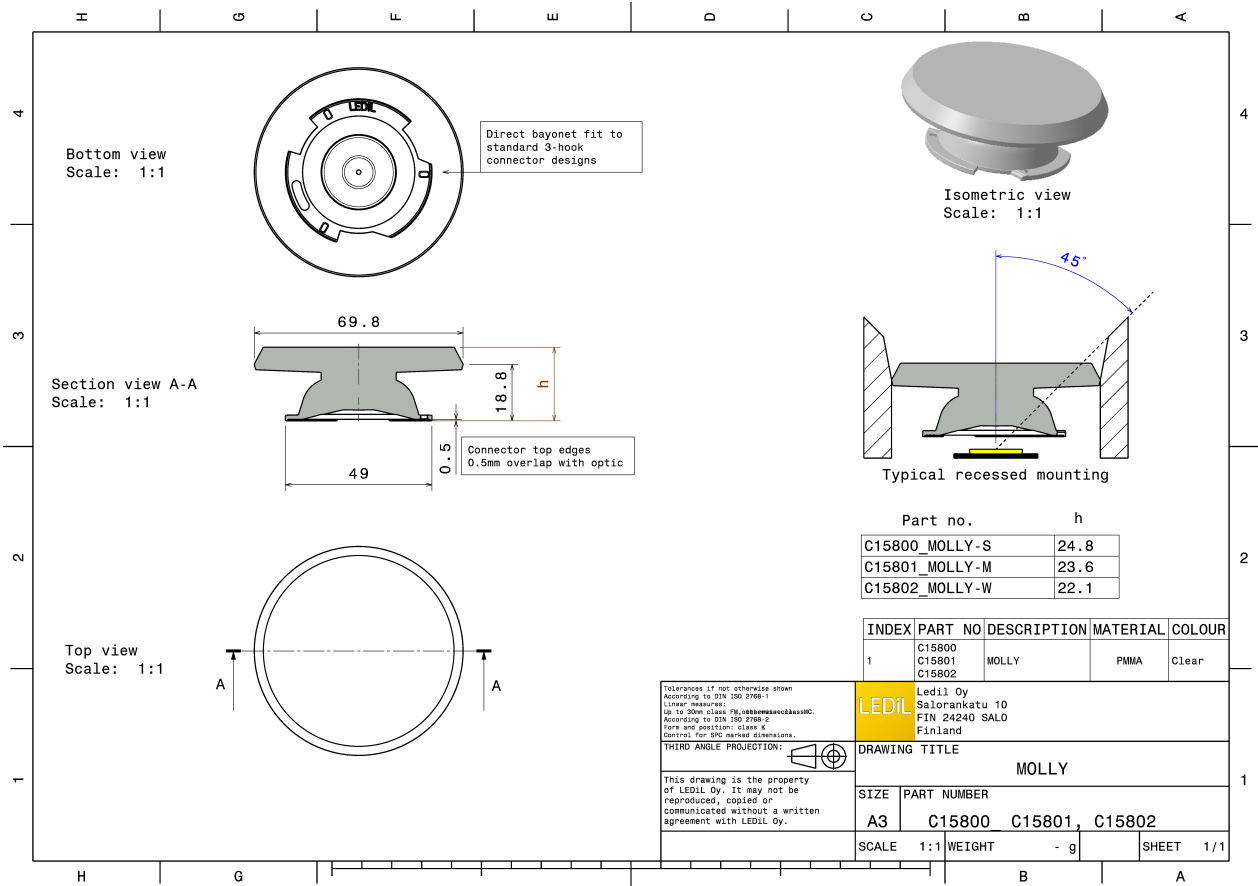

ORDERING INFORMATION:

Component	Qty in box	MOQ	MPQ	Box weight (kg)
C15802_MOLLY-W » Box size: 476 x 273 x 292 mm	198	36	18	8.1

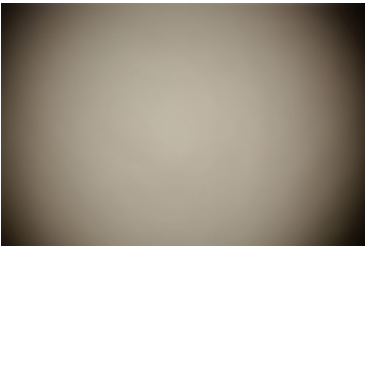
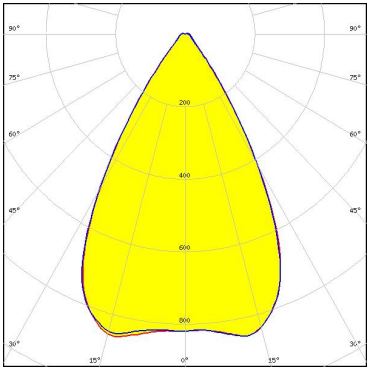

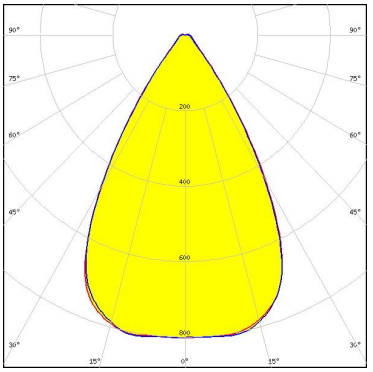
See also our general installation guide: www.ledil.com/installation_guide

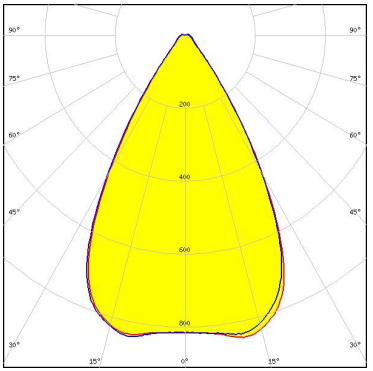
PHOTOMETRIC DATA (MEASURED):

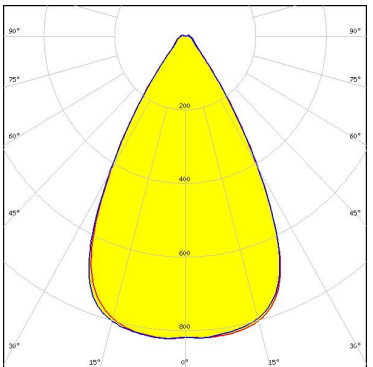
<p></p> <p>LED Vero SE 13 FWHM / FWTM 62.0° / 85.0° Efficiency 90 % Peak intensity 0.9 cd/m LEDs/each optic 1 Light colour White Required components: C16402_CLAMP-VEROSE-13-18</p>		
<p></p> <p>LED Vero SE 18 FWHM / FWTM 62.0° / 87.0° Efficiency 90 % Peak intensity 0.8 cd/m LEDs/each optic 1 Light colour White Required components: C16402_CLAMP-VEROSE-13-18</p>		
<p></p> <p>LED Vesta TW 15mm DP FWHM / FWTM 61.0° / 85.0° Efficiency 90 % Peak intensity 0.8 cd/m LEDs/each optic 1 Light colour Tunable White Required components: C13658_CLAMP-VERO13-18 Bender Wirth: 482 Typ L2</p>		
<p></p> <p>LED Vesta TW 18mm (31W) DP FWHM / FWTM 60.0° / 86.0° Efficiency 89 % Peak intensity 0.8 cd/m LEDs/each optic 1 Light colour Tunable White Required components: C13584_CLAMP-VERO29 Bender Wirth: 483 Typ L3</p>		

PHOTOMETRIC DATA (MEASURED):



LED Vesta TW 22mm DP
 FWHM / FWTM 61.0° / 87.0°
 Efficiency 88 %
 Peak intensity 0.8 cd/lm
 LEDs/each optic 1
 Light colour Tunable White
 Required components:
 C13584_CLAMP-VERO29
 Bender Wirth: 494 Typ L3

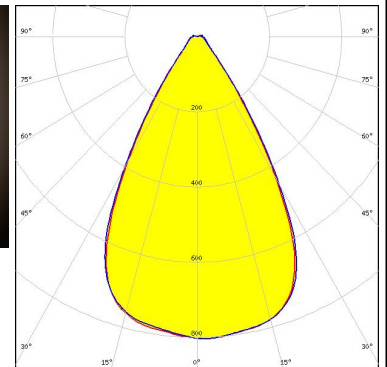

CITIZEN

LED CLL03x/CLU03x
 FWHM / FWTM 61.0° / 86.0°
 Efficiency 89 %
 Peak intensity 0.9 cd/lm
 LEDs/each optic 1
 Light colour White
 Required components:
 Bender Wirth: 433 Typ L1



CITIZEN

LED CLL03x/CLU03x
 FWHM / FWTM 58.0° / 83.0°
 Efficiency 90 %
 Peak intensity 0.9 cd/lm
 LEDs/each optic 1
 Light colour White
 Required components:
 C16791_CLAMP-Z45-A
 TE Connectivity: 2325807-3

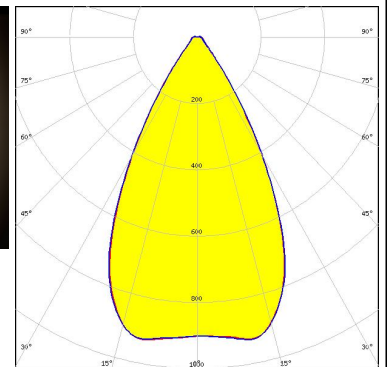

CITIZEN

LED LCN-C02B (Tunable White)
 FWHM / FWTM 62.0° / 84.0°
 Efficiency 89 %
 Peak intensity 0.9 cd/lm
 LEDs/each optic 1
 Light colour White
 Required components:
 C13658_CLAMP-VERO13-18
 Bender Wirth: 481 Typ L2

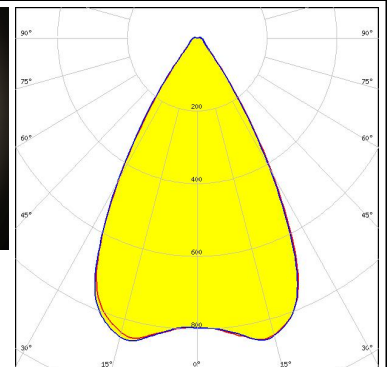
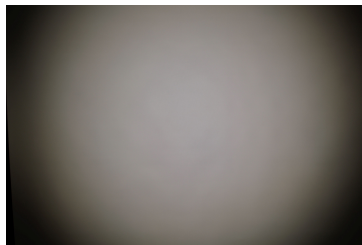

PHOTOMETRIC DATA (MEASURED):

CREE LED

LED CMA1840
FWHM / FWTM 64.0 + ° / 87.0°
Efficiency 91 %
Peak intensity 0.8 cd/m
LEDs/each optic 1
Light colour White
Required components:
C14123_CLAMP-CXA15-18

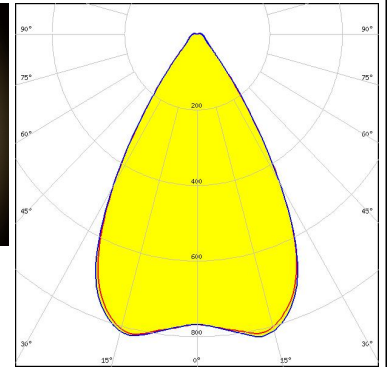

CREE LED

LED CMA2550
FWHM / FWTM 63.0° / 88.0°
Efficiency 89 %
Peak intensity 0.8 cd/m
LEDs/each optic 1
Light colour White
Required components:
C14036_CLAMP_CXA25-30

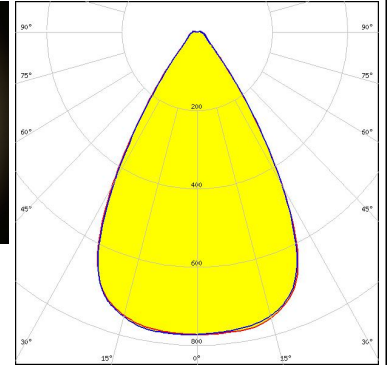
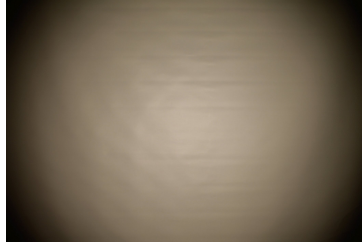

CREE LED

LED CMA3090
FWHM / FWTM 64.0° / 89.0°
Efficiency 89 %
Peak intensity 0.8 cd/m
LEDs/each optic 1
Light colour White
Required components:
C14036_CLAMP_CXA25-30

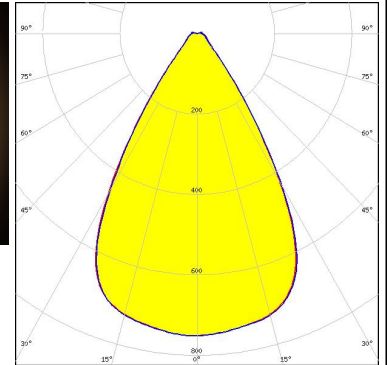

CREE LED

LED CMT14xx
FWHM / FWTM 60.0° / 83.0°
Efficiency 90 %
Peak intensity 0.9 cd/m
LEDs/each optic 1
Light colour White
Required components:
C13658_CLAMP-VERO13-18
Bender Wirth: 434 Typ L1

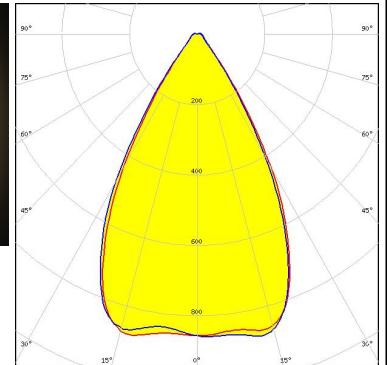

PHOTOMETRIC DATA (MEASURED):

CREE LED

LED CMT19xx
 FWHM / FWTM 61.0° / 85.0°
 Efficiency 90 %
 Peak intensity 0.8 cd/lm
 LEDs/each optic 1
 Light colour White
 Required components:
 C13658_CLAMP-VERO13-18
 Bender Wirth: 477 Typ L1

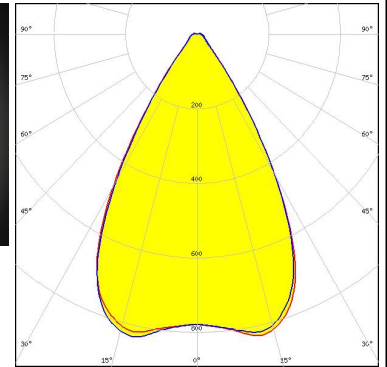

CREE LED

LED CMT28xx
 FWHM / FWTM 61.0° / 87.0°
 Efficiency 88 %
 Peak intensity 0.8 cd/lm
 LEDs/each optic 1
 Light colour White
 Required components:
 C13584_CLAMP-VERO29
 Bender Wirth: 471 Typ L3

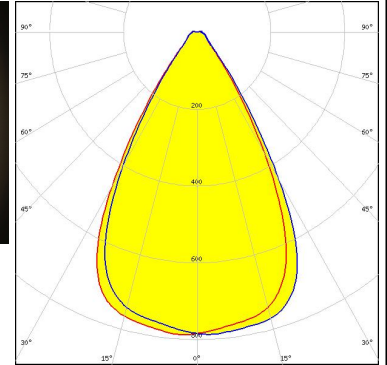
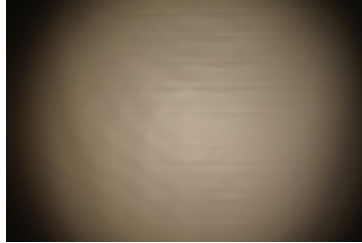

CREE LED

LED CXA/B 15xx
 FWHM / FWTM 61.0° / 84.0°
 Efficiency 90 %
 Peak intensity 0.9 cd/lm
 LEDs/each optic 1
 Light colour White
 Required components:
 C14123_CLAMP-CXA15-18

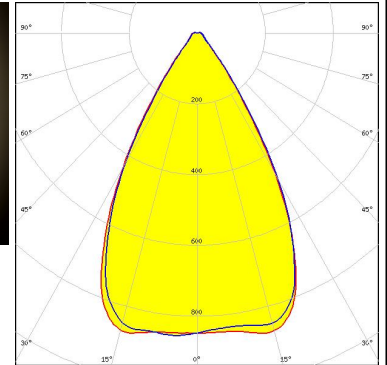





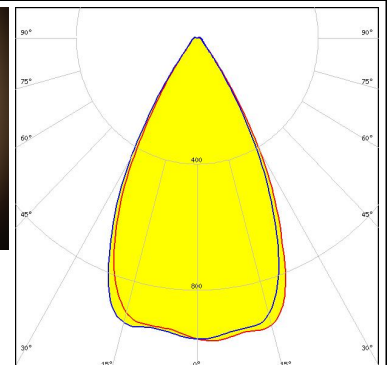
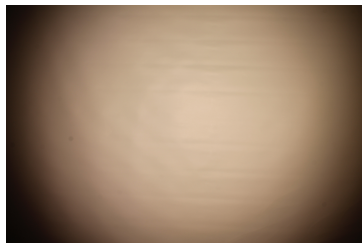

LUMILEDS

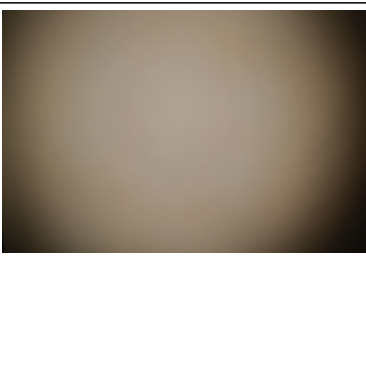
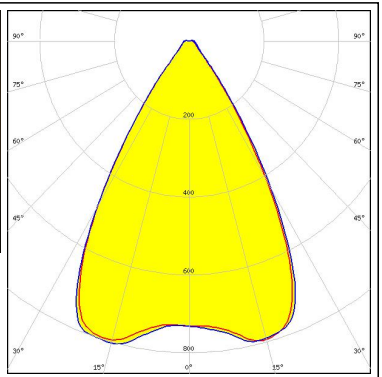
LED LUXEON CoB 1204HD
 FWHM / FWTM 57.0° / 80.0°
 Efficiency 89 %
 Peak intensity 1 cd/lm
 LEDs/each optic 1
 Light colour White
 Required components:
 TE Connectivity: 2213382-2 + OPTIC CLIP Z50 TYPE1 2213194-1

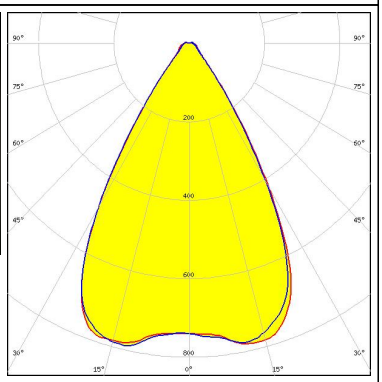

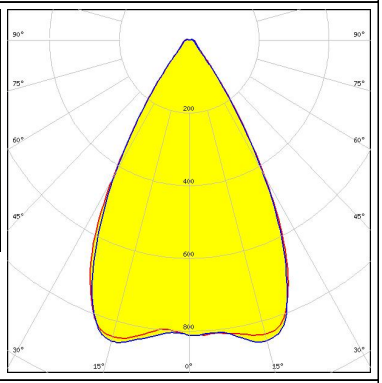
PHOTOMETRIC DATA (MEASURED):

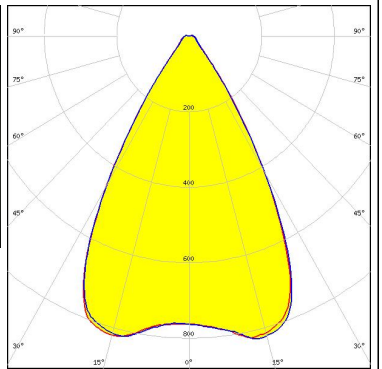
<p>LUMINUS</p> <p>LED CDM-14 (Dim-To-Warm) FWHM / FWTM 64.0° / 86.0° Efficiency 89 % Peak intensity 0.8 cd/lm LEDs/each optic 1 Light colour White</p> <p>Required components: C13658_CLAMP-VERO13-18 Bender Wirth: 491 Typ L2</p>		
<p>LUMINUS</p> <p>LED CDM-18 (Dim-To-Warm) FWHM / FWTM 63.0° / 87.0° Efficiency 89 % Peak intensity 0.8 cd/lm LEDs/each optic 1 Light colour White</p> <p>Required components: C13658_CLAMP-VERO13-18 Bender Wirth: 491 Typ L2</p>		
<p>LUMINUS</p> <p>LED CDM-9 (Dim-To-Warm) FWHM / FWTM 61.0° / 83.0° Efficiency 89 % Peak intensity 0.9 cd/lm LEDs/each optic 1 Light colour White</p> <p>Required components: C13658_CLAMP-VERO13-18 Bender Wirth: 490 Typ L1</p>		
<p>LUMINUS</p> <p>LED CTM-14 (Tunable White) FWHM / FWTM 62.0° / 85.0° Efficiency 88 % Peak intensity 0.8 cd/lm LEDs/each optic 1 Light colour White</p> <p>Required components: C13584_CLAMP-VERO29 Bender Wirth: 442 Typ L3</p>		

PHOTOMETRIC DATA (MEASURED):



LED CTM-14 RGBW
 FWHM / FWTM 61.0° / 84.0°
 Efficiency 89 %
 Peak intensity 0.8 cd/lm
 LEDs/each optic 1
 Light colour RGBW
 Required components:
 C13584_CLAMP-VERO29
 Bender Wirth: 500 Typ L3-1

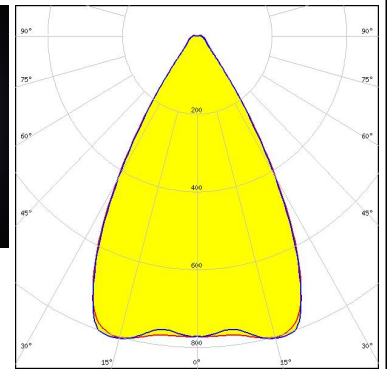
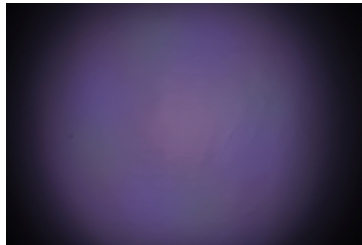

LED CTM-22 (Tunable White)
 FWHM / FWTM 62.0° / 88.0°
 Efficiency 87 %
 Peak intensity 0.7 cd/lm
 LEDs/each optic 1
 Light colour White
 Required components:
 C13584_CLAMP-VERO29
 Bender Wirth: 494 Typ L3

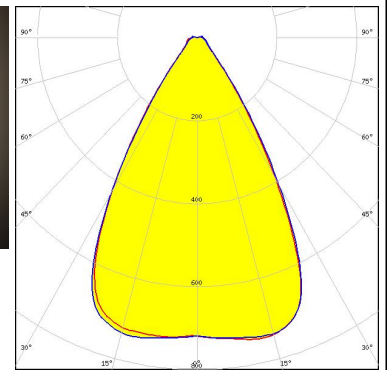
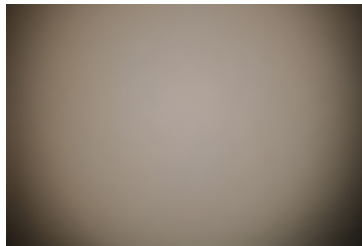

LED NVCWJ024Z-V1MT: COB J-Type Tunable White
 FWHM / FWTM 60.0° / 82.0°
 Efficiency 89 %
 Peak intensity 0.9 cd/lm
 LEDs/each optic 1
 Light colour White
 Required components:
 C13658_CLAMP-VERO13-18
 Bender Wirth: 498 Typ L2

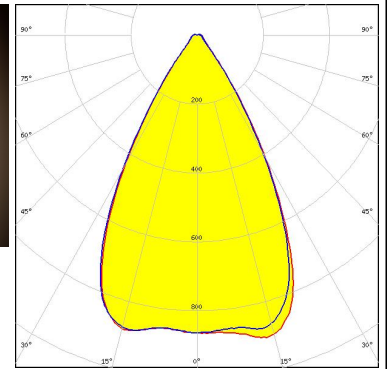

LED PrevaLED Core G7 L15 H1
 FWHM / FWTM 57.0° / 82.0°
 Efficiency 90 %
 Peak intensity 1 cd/lm
 LEDs/each optic 1
 Light colour White
 Required components:
 C16685_CLAMP-PRV-A

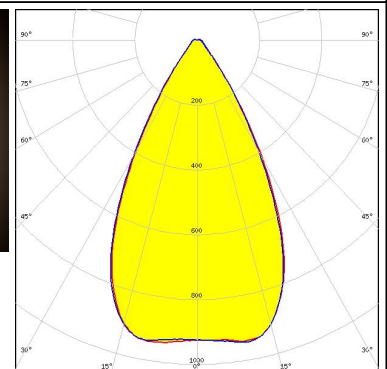
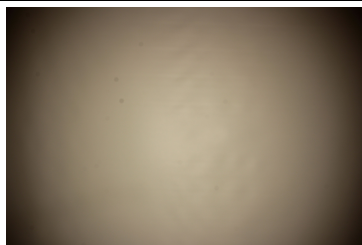

PHOTOMETRIC DATA (MEASURED):

PHILIPS

LED Fortimo SLM L13 CoB
 FWHM / FWTM 60.0° / 83.0°
 Efficiency 89 %
 Peak intensity 0.9 cd/m
 LEDs/each optic 1
 Light colour White

Required components:

TE Connectivity: 2213130-2 + OPTIC CLIP Z50 TYPE1 2213194-1

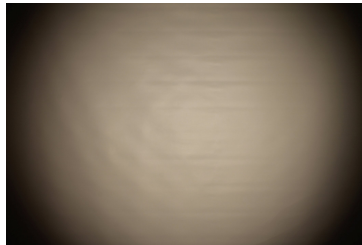

PHILIPS

LED Fortimo SLM L15 + SLM holder
 FWHM / FWTM 57.0° / 81.0°
 Efficiency 89 %
 Peak intensity 0.9 cd/m
 LEDs/each optic 1
 Light colour White

Required components:

TE Connectivity: OPTIC CLIP Z50 TYPE1 2213194-1

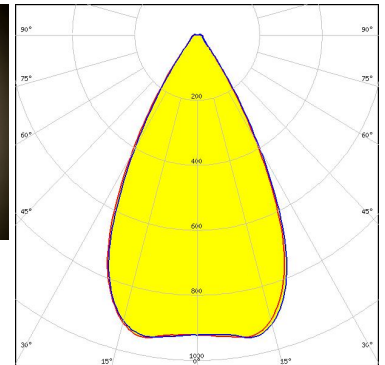
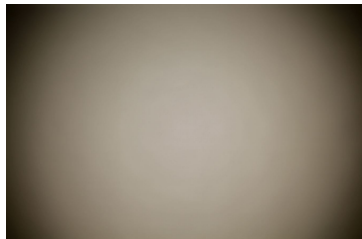

PHILIPS

LED Fortimo SLM L15 CoB
 FWHM / FWTM 60.0° / 83.0°
 Efficiency 88 %
 Peak intensity 0.9 cd/m
 LEDs/each optic 1
 Light colour White

Required components:

TE Connectivity: 2213130-2 + OPTIC CLIP Z50 TYPE1 2213194-1

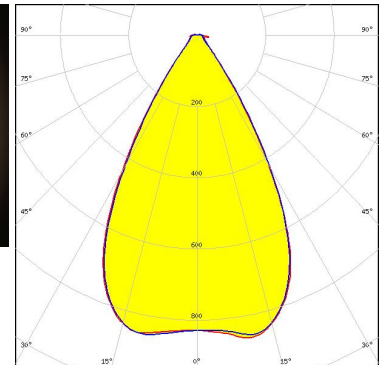
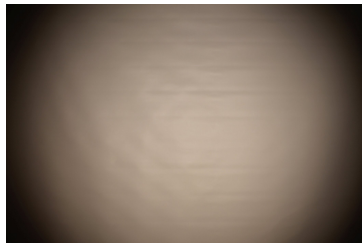

SAMSUNG

LED LC035T (Tunable white)
 FWHM / FWTM 62.0° / 88.0°
 Efficiency 89 %
 Peak intensity 0.8 cd/m
 LEDs/each optic 1
 Light colour Tunable White

Required components:

C13584_CLAMP-VERO29
 Bender Wirth: 502 Typ L3

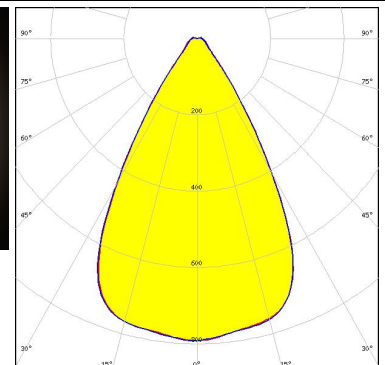
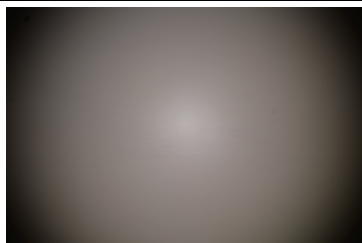

PHOTOMETRIC DATA (MEASURED):

XICATO

LED XTM - 19mm LES
FWHM / FWTM 60.0° / 85.0°
Efficiency 90 %
Peak intensity 0.9 cd/lm
LEDs/each optic 1
Light colour White
Required components:
C16491_XTM-ADAPTER-50-A

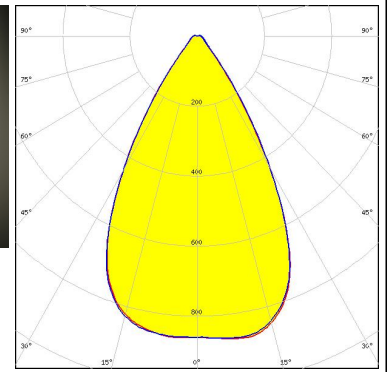

PHOTOMETRIC DATA (SIMULATED):

bridgelux.

LED V9 HD
 FWHM / FWTM 58.0° / 77.0°
 Efficiency 90 %
 Peak intensity 1 cd/lm
 LEDs/each optic 1
 Light colour White
 Required components:
 C13658_CLAMP-VERO13-18
 Bender Wirth: 496 Typ L1

bridgelux.

LED VERO13
 FWHM / FWTM 55.0° / 75.0°
 Efficiency 90 %
 Peak intensity 1.1 cd/lm
 LEDs/each optic 1
 Light colour White
 Required components:
 C13658_CLAMP-VERO13-18

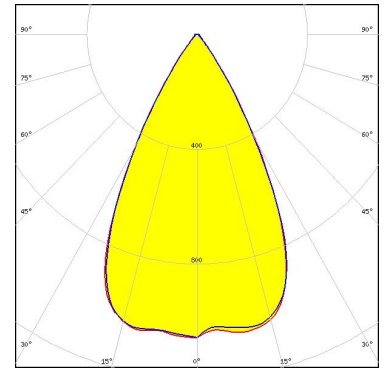

CITIZEN

LED CLL02x/CLU02x (LES10)
 FWHM / FWTM 54.0° / 73.0°
 Efficiency 89 %
 Peak intensity 1.2 cd/lm
 LEDs/each optic 1
 Light colour White
 Required components:
 Bender Wirth: 434 Typ L1

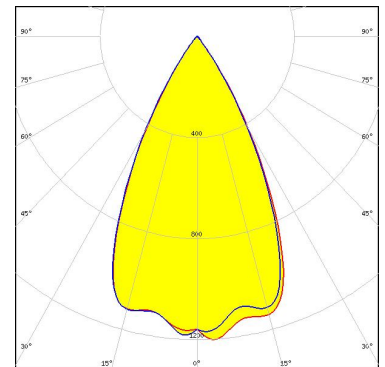

CREE LED

LED CXA/B 1816 & CXA/B 1820 & CXA 1850
 FWHM / FWTM 58.0° / 78.0°
 Efficiency 90 %
 Peak intensity 1.1 cd/lm
 LEDs/each optic 1
 Light colour White
 Required components:
 C14123_CLAMP-CXA15-18

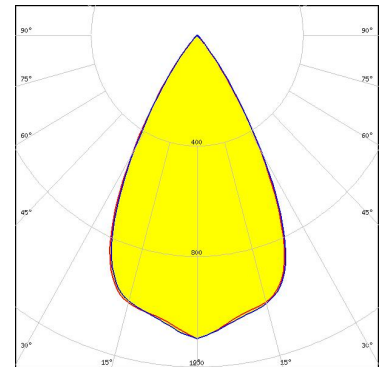

PHOTOMETRIC DATA (SIMULATED):



LED CXA/B 25xx
FWHM / FWTM 57.0° / 77.0°
Efficiency %
Peak intensity 1.1 cd/lm
LEDs/each optic 1
Light colour White
Required components:
C14036_CLAMP_CXA25-30

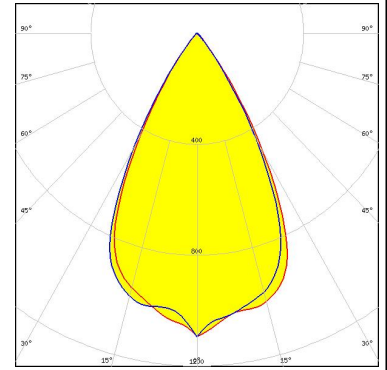

LED CTM-18 (Tunable White)
FWHM / FWTM 54.0° / 75.0°
Efficiency 80 %
Peak intensity 1 cd/lm
LEDs/each optic 1
Light colour White
Required components:
C13658_CLAMP-VERO13-18