

### OLGA-RS

~9° spot beam with flange. Optimized for high-power 3535 size LED packages.

#### SPECIFICATION:

Dimensions	Ø 29.7 mm
Height	18.4 mm
ROHS compliant	yes ⓘ



#### MATERIALS:

Component	Type	Material	Colour	Finish
OLGA-RS	Single lens	PMMA	clear	

#### ORDERING INFORMATION:

Component	Qty in box	MOQ	MPQ	Box weight (kg)
C16671_OLGA-RS » Box size: 476 x 273 x 292 mm	792	132	66	7.3

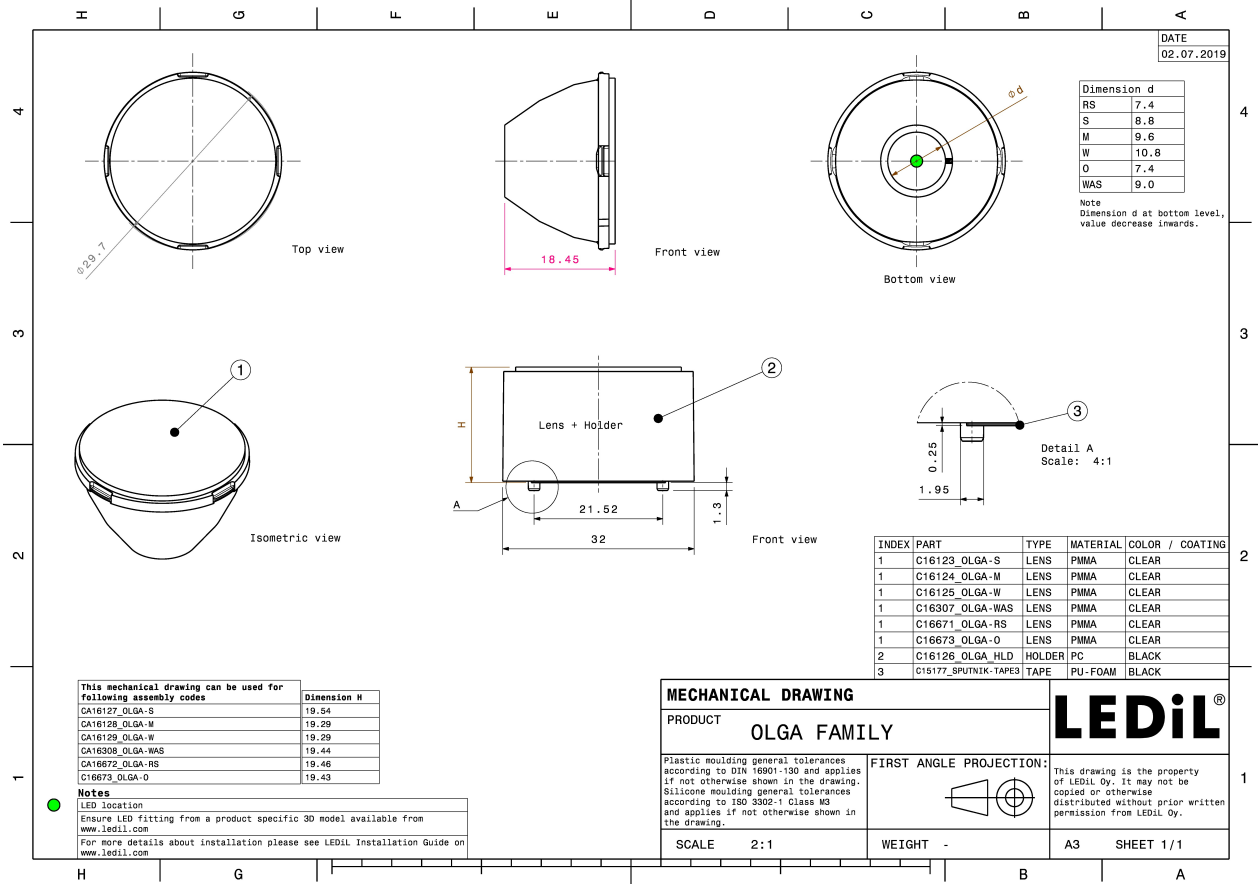

See also our general installation guide: [www.ledil.com/installation\\_guide](http://www.ledil.com/installation_guide)

### OPTICAL RESULTS (MEASURED):



LED Vesta TW 6mm DP  
 FWHM / FWTM 16.0° / 51.0°  
 Efficiency 85 %  
 Peak intensity 3.8 cd/lm  
 LEDs/each optic 1  
 Light colour White  
 Required components:

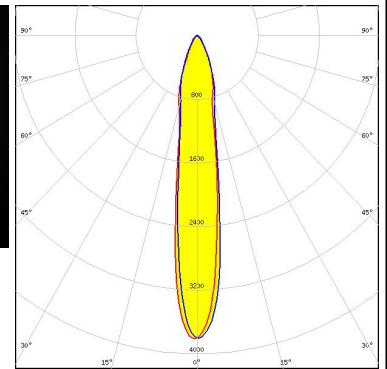

### CITIZEN

LED CLU7B2  
 FWHM / FWTM 9.0° / 31.0°  
 Efficiency 84 %  
 Peak intensity 10.3 cd/lm  
 LEDs/each optic 1  
 Light colour White  
 Required components:

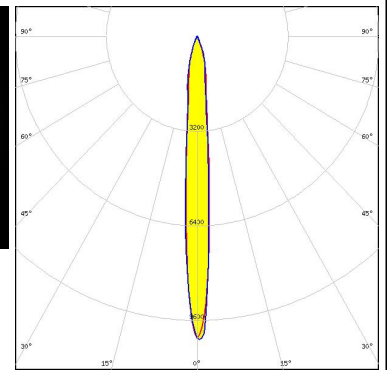

### CITIZEN

LED CLU7L3  
 FWHM / FWTM 7.0° / 29.0°  
 Efficiency 89 %  
 Peak intensity 13.3 cd/lm  
 LEDs/each optic 1  
 Light colour White  
 Required components:

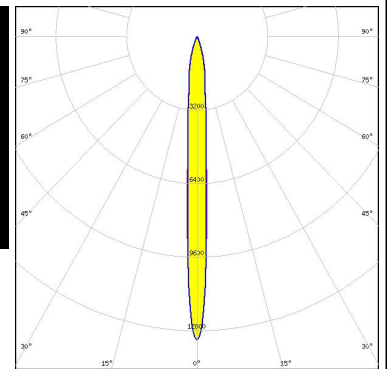

### CITIZEN

LED CLU7R3  
 FWHM / FWTM 12.0° / 41.0°  
 Efficiency 87 %  
 Peak intensity 6.7 cd/lm  
 LEDs/each optic 1  
 Light colour White  
 Required components:

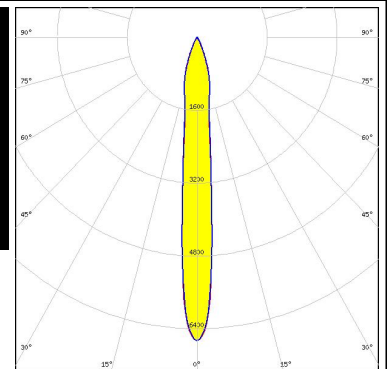
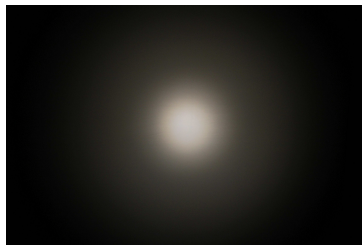

#### OPTICAL RESULTS (MEASURED):

### CITIZEN

LED CLU7S3  
 FWHM / FWTM 10.0° / 37.0°  
 Efficiency 93 %  
 Peak intensity 9.1 cd/lm  
 LEDs/each optic 1  
 Light colour White  
 Required components:

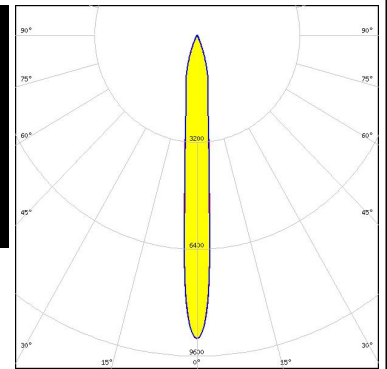

LED XHP35 HD  
 FWHM / FWTM 13.0° / 29.0°  
 Efficiency 84 %  
 Peak intensity 9.8 cd/lm  
 LEDs/each optic 1  
 Light colour White  
 Required components:

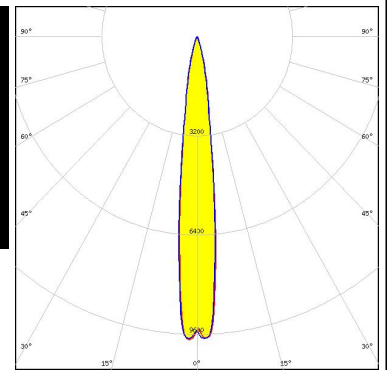

LED XP-E2  
 FWHM / FWTM 5.0° / 12.0°  
 Efficiency 86 %  
 Peak intensity 50.5 cd/lm  
 LEDs/each optic 1  
 Light colour White  
 Required components:

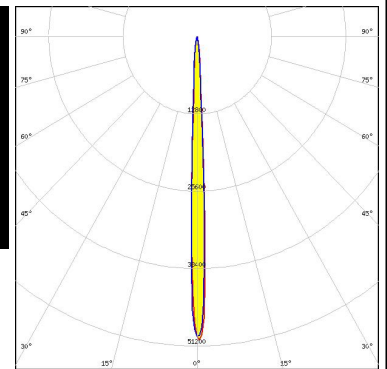
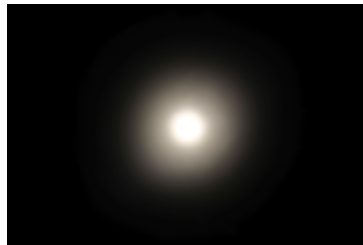

LED XP-L2  
 FWHM / FWTM 12.0° / 29.0°  
 Efficiency 83 %  
 Peak intensity 10.7 cd/lm  
 LEDs/each optic 1  
 Light colour White  
 Required components:

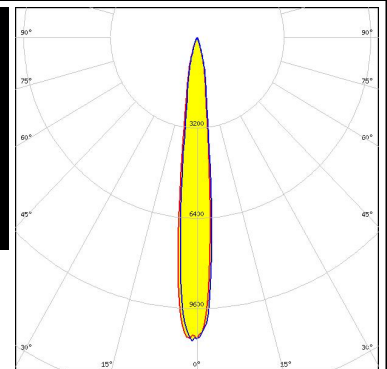



### OPTICAL RESULTS (MEASURED):

#### OSRAM

Opto Semiconductors

LED OSCONIQ P 3737 (3W version)  
 FWHM / FWTM 10.0° / 25.0°  
 Efficiency 85 %  
 Peak intensity 14.5 cd/lm  
 LEDs/each optic 1  
 Light colour White  
 Required components:

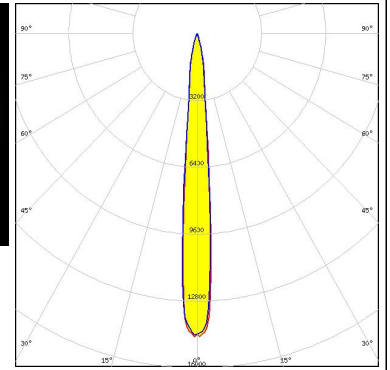
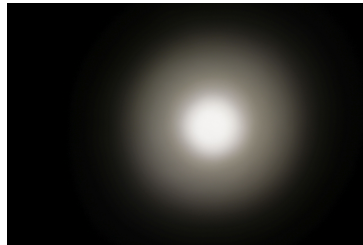

#### OSRAM

Opto Semiconductors

LED OSLON Square CSSRM2/CSSRM3  
 FWHM / FWTM 7.0° / 17.0°  
 Efficiency 86 %  
 Peak intensity 26.6 cd/lm  
 LEDs/each optic 1  
 Light colour White  
 Required components:

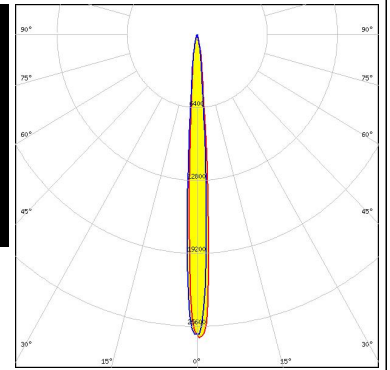
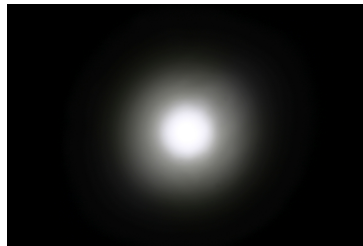

#### SAMSUNG

LED LH351D  
 FWHM / FWTM 12.0° / 26.0°  
 Efficiency 86 %  
 Peak intensity 12.1 cd/lm  
 LEDs/each optic 1  
 Light colour White  
 Required components:

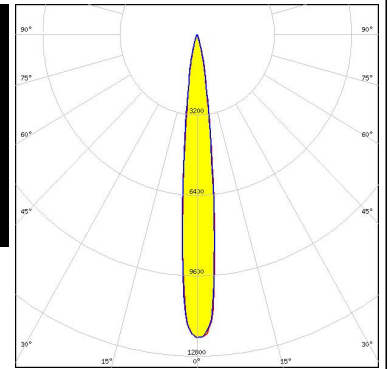
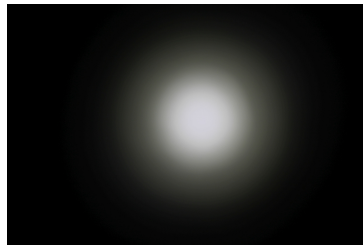

### OPTICAL RESULTS (SIMULATED):

bridgelux.

LED V3 HD Gen 8  
 FWHM / FWTM 14.0° / 26.0°  
 Efficiency 96 %  
 Peak intensity 13 cd/lm  
 LEDs/each optic 1  
 Light colour White  
 Required components:

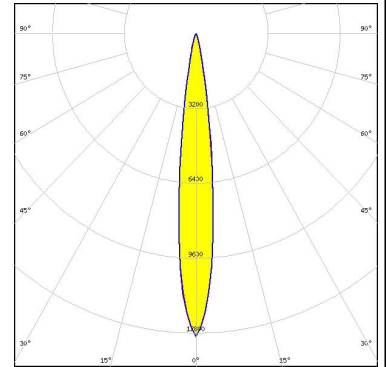

bridgelux.

LED V4 HD Gen 7  
 FWHM / FWTM 16.0° / 31.0°  
 Efficiency 96 %  
 Peak intensity 9.1 cd/lm  
 LEDs/each optic 1  
 Light colour White  
 Required components:

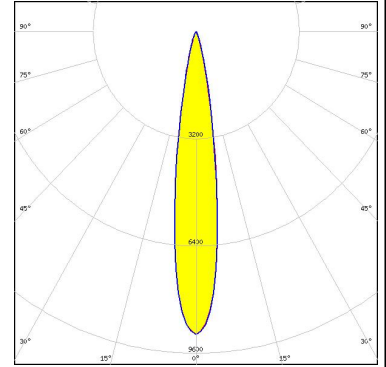

bridgelux.

LED V6 HD Gen 7  
 FWHM / FWTM 18.0° / 46.0°  
 Efficiency 93 %  
 Peak intensity 5.1 cd/lm  
 LEDs/each optic 1  
 Light colour White  
 Required components:

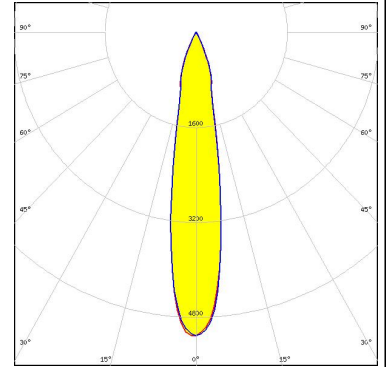

### CITIZEN

LED CLU7A2/7A3  
 FWHM / FWTM 12.0° / 27.0°  
 Efficiency 91 %  
 Peak intensity 13 cd/lm  
 LEDs/each optic 1  
 Light colour White  
 Required components:

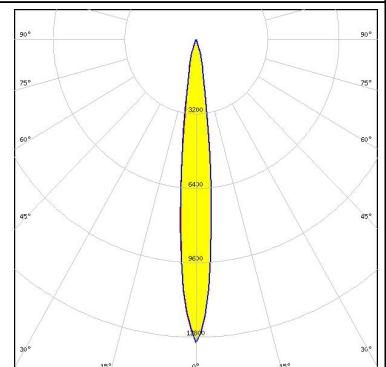

### OPTICAL RESULTS (SIMULATED):



LED CMA1303  
 FWHM / FWTM 16.0° / 30.0°  
 Efficiency 95 %  
 Peak intensity 9.5 cd/lm  
 LEDs/each optic 1  
 Light colour White  
 Required components:

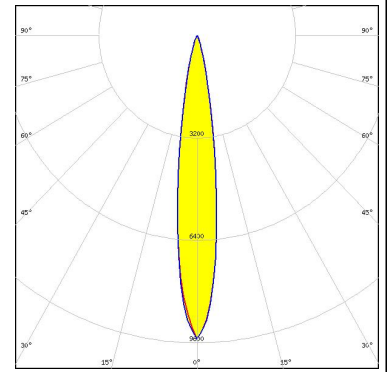

LED CXA/B 13xx  
 FWHM / FWTM 18.0° / 45.0°  
 Efficiency 89 %  
 Peak intensity 4.9 cd/lm  
 LEDs/each optic 1  
 Light colour White  
 Required components:

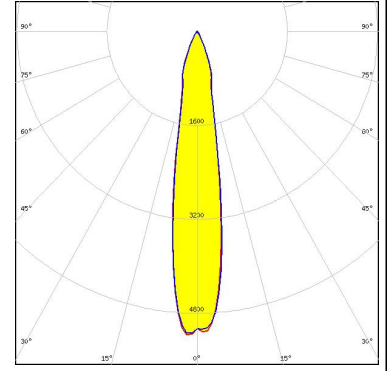

LED XHP35 HI  
 FWHM / FWTM 10.0° / 20.0°  
 Efficiency 96 %  
 Peak intensity 23.2 cd/lm  
 LEDs/each optic 1  
 Light colour White  
 Required components:

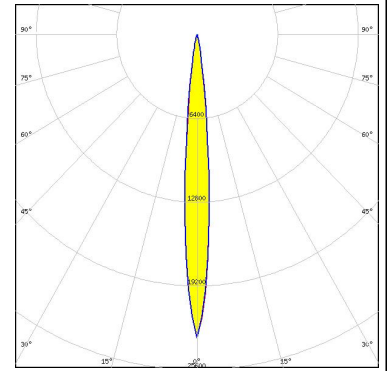

LED CXM-3  
 FWHM / FWTM 12.0° / 26.0°  
 Efficiency 96 %  
 Peak intensity 14 cd/lm  
 LEDs/each optic 1  
 Light colour White  
 Required components:

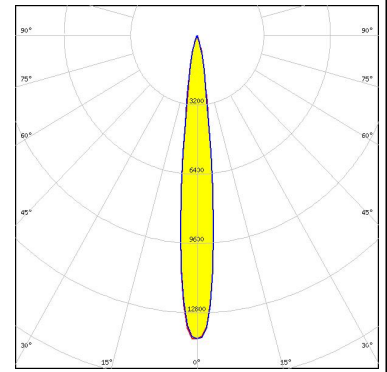

### OPTICAL RESULTS (SIMULATED):



LED CXM-4  
FWHM / FWTM 14.0° / 38.0°  
Efficiency 96 %  
Peak intensity 8.3 cd/lm  
LEDs/each optic 1  
Light colour White  
Required components:

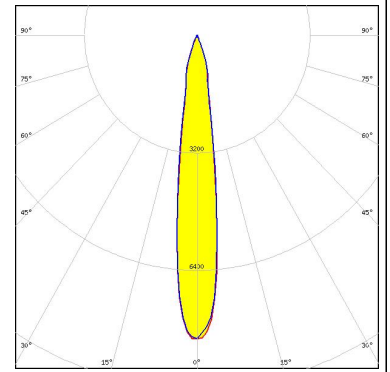

### XICATO

LED XOB 6 mm  
FWHM / FWTM 18.0° / 46.0°  
Efficiency 94 %  
Peak intensity 5.5 cd/lm  
LEDs/each optic 1  
Light colour White  
Required components:

