

## ILONA-RS

~10° spot beam

### SPECIFICATION:

Dimensions	Ø 49.8 mm
Height	29.3 mm
Fastening	socket
ROHS compliant	yes ⓘ

### MATERIALS:

Component	Type	Material	Colour	Finish
ILONA-RS	Single lens	PMMA	clear	







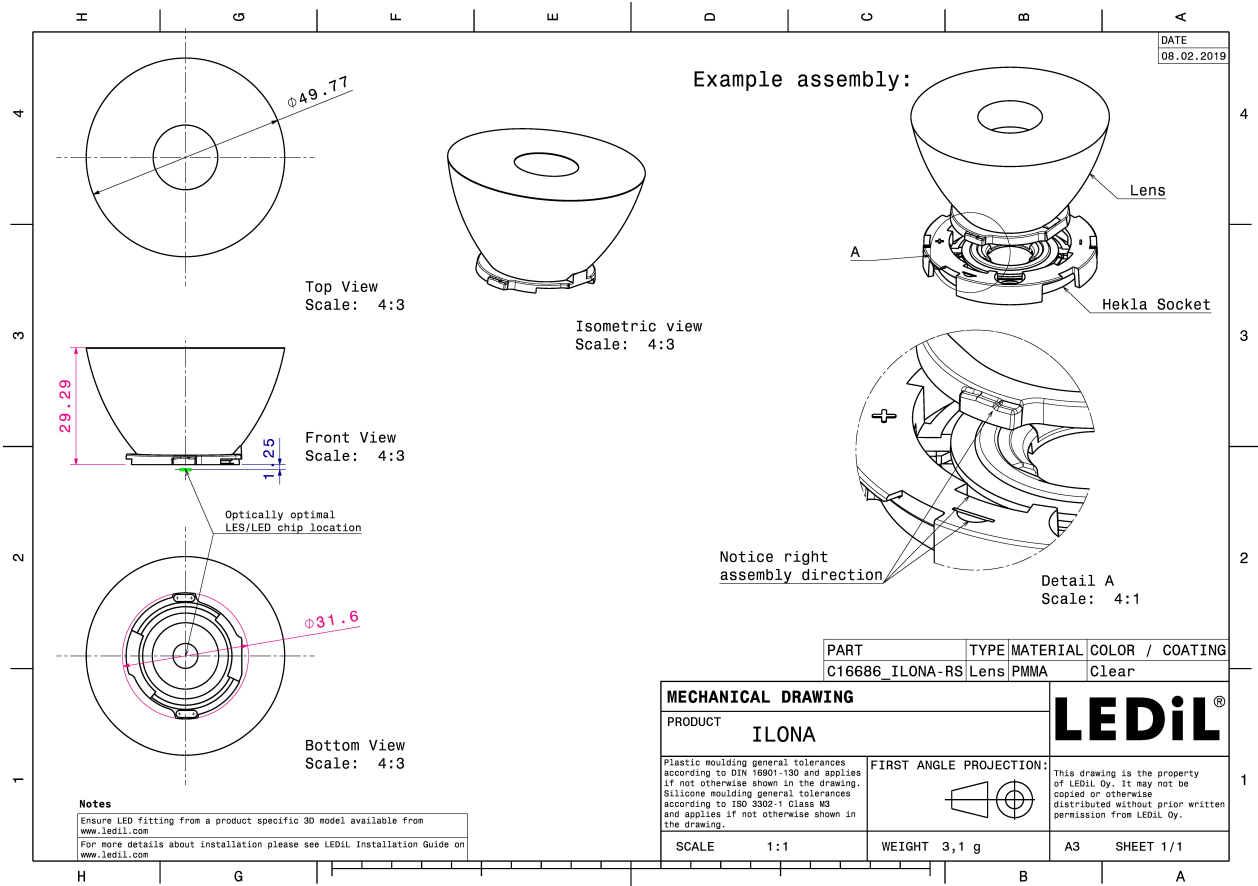



### ORDERING INFORMATION:

Component	Qty in box	MOQ	MPQ	Box weight (kg)
C16686_ILONA-RS » Box size: 480 x 280 x 300 mm	264	99	33	9.6

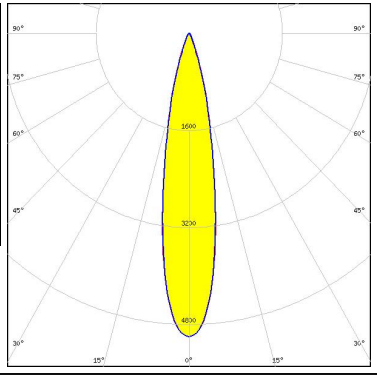

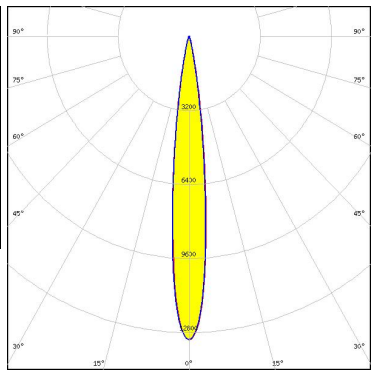
See also our general installation guide: [www.ledil.com/installation\\_guide](http://www.ledil.com/installation_guide)

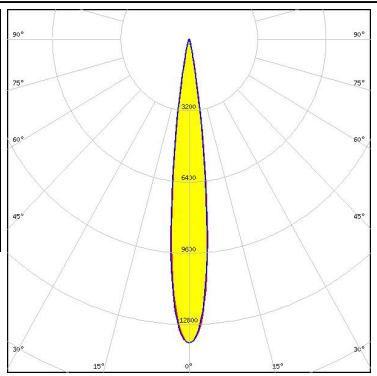
### OPTICAL RESULTS (MEASURED):

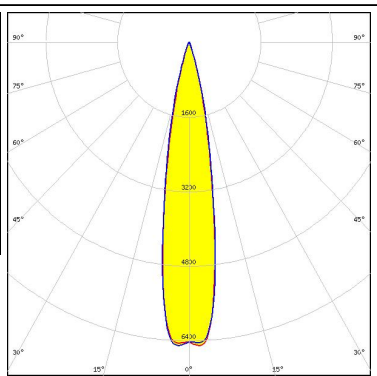
<p></p> <p>LED V11 HD Gen 8            FWHM / FWTM 20.0° / 40.0°            Efficiency 93 %            Peak intensity 5 cd/lm            LEDs/each optic 1            Light colour White            Required components:            Bender Wirth: 633d Hekla</p>		
<p></p> <p>LED V6 HD Gen 7            FWHM / FWTM 13.0° / 24.0°            Efficiency 94 %            Peak intensity 13.1 cd/lm            LEDs/each optic 1            Light colour White            Required components:            Bender Wirth: 634c Hekla</p>		
<p></p> <p>LED V6 HD Gen 7            FWHM / FWTM 14.0° / 23.0°            Efficiency 95 %            Peak intensity 13.6 cd/lm            LEDs/each optic 1            Light colour White            Required components:            F15255_HEKLA-SOCKET-C</p>		
<p></p> <p>LED Vesta DTW 9mm (4W/6W/12W)            FWHM / FWTM 19.0° / 34.0°            Efficiency 93 %            Peak intensity 6.5 cd/lm            LEDs/each optic 1            Light colour White            Required components:            C16142_HEKLA-SOCKET-K            Bender Wirth: 490 Typ L8</p>		

### OPTICAL RESULTS (MEASURED):



LED Vesta TW 6mm DP  
 FWHM / FWTM 14.0° / 25.0°  
 Efficiency 91 %  
 Peak intensity 12.2 cd/lm  
 LEDs/each optic 1  
 Light colour White  
 Required components:  
 C16142\_HEKLA-SOCKET-K  
 Bender Wirth: 504 Typ L8

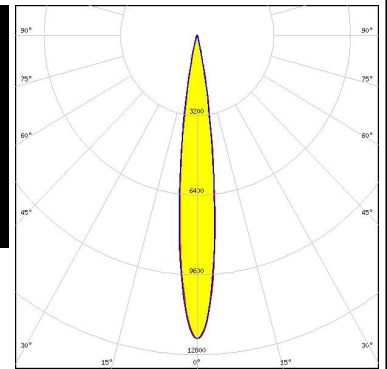

### CITIZEN

LED CLU700/701/702/703  
 FWHM / FWTM 12.0° / 22.0°  
 Efficiency 96 %  
 Peak intensity 15.3 cd/lm  
 LEDs/each optic 1  
 Light colour White  
 Required components:  
 F15255\_HEKLA-SOCKET-C

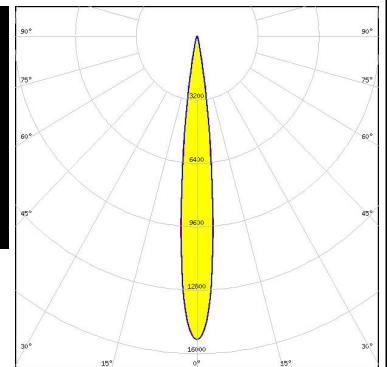

### CITIZEN

LED CLU7A2/7A3  
 FWHM / FWTM 9.0° / 17.0°  
 Efficiency 94 %  
 Peak intensity 26 cd/lm  
 LEDs/each optic 1  
 Light colour White  
 Required components:  
 F15255\_HEKLA-SOCKET-C

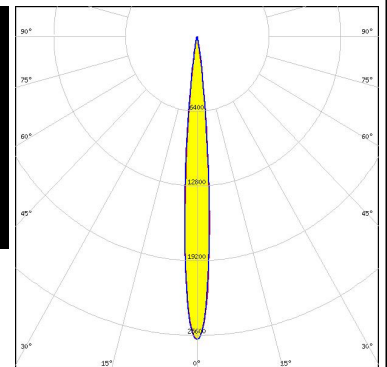
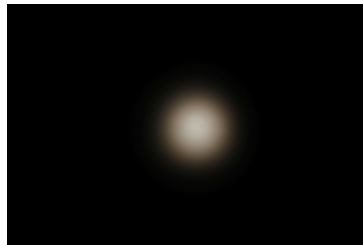



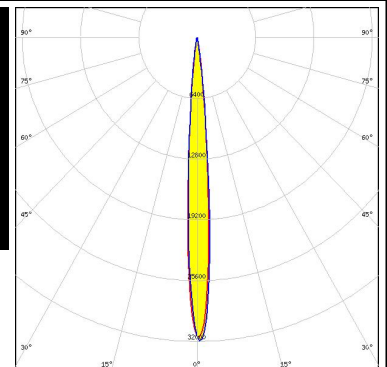
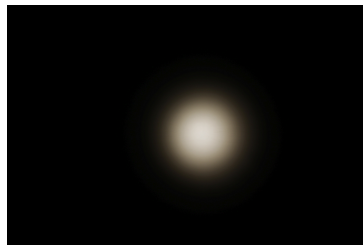

### CITIZEN

LED CLU7B2  
 FWHM / FWTM 8.0° / 16.0°  
 Efficiency 94 %  
 Peak intensity 32.2 cd/lm  
 LEDs/each optic 1  
 Light colour White  
 Required components:  
 F15255\_HEKLA-SOCKET-C

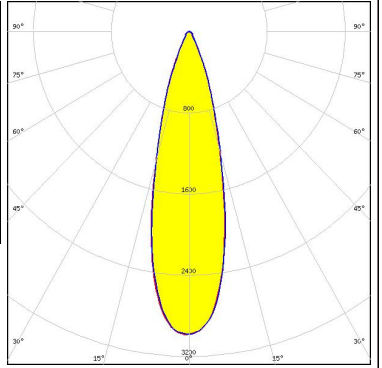
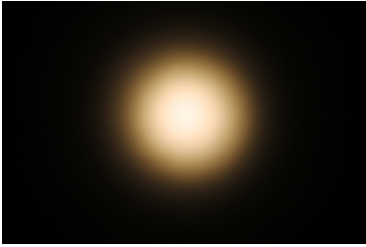
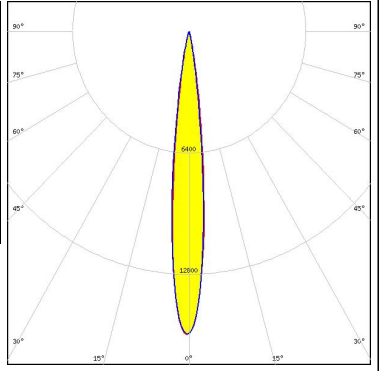

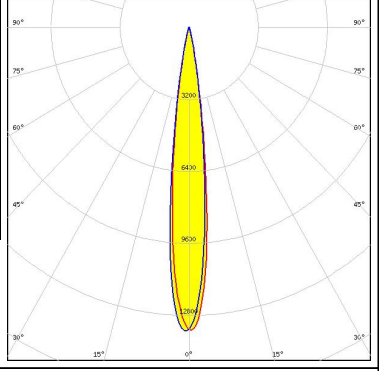
### OPTICAL RESULTS (MEASURED):

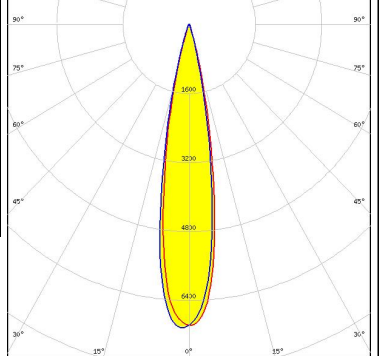
<p><b>LUMILEDS</b></p> <p>LED LUXEON CX Plus CoB L08 (Gen2)</p> <p>FWHM / FWTM 28.0° / 52.0°</p> <p>Efficiency 93 %</p> <p>Peak intensity 3 cd/lm</p> <p>LEDs/each optic 1</p> <p>Light colour White</p> <p>Required components: Bender Wirth: 637a Hekla</p>		
<p><b>LUMILEDS</b></p> <p>LED LUXEON CX Plus CoB - HD S01H4</p> <p>FWHM / FWTM 12.0° / 22.0°</p> <p>Efficiency 94 %</p> <p>Peak intensity 16 cd/lm</p> <p>LEDs/each optic 1</p> <p>Light colour White</p> <p>Required components: Bender Wirth: 634c Hekla</p>		
<p><b>LUMILEDS</b></p> <p>LED LUXEON CX Plus CoB - HD S02H6</p> <p>FWHM / FWTM 13.0° / 24.0°</p> <p>Efficiency 94 %</p> <p>Peak intensity 13.6 cd/lm</p> <p>LEDs/each optic 1</p> <p>Light colour White</p> <p>Required components: Bender Wirth: 634c Hekla</p>		
<p><b>LUMILEDS</b></p> <p>LED LUXEON CX Plus CoB - HD S04H9</p> <p>FWHM / FWTM 19.0° / 33.0°</p> <p>Efficiency 94 %</p> <p>Peak intensity 7 cd/lm</p> <p>LEDs/each optic 1</p> <p>Light colour White</p> <p>Required components: Bender Wirth: 634c Hekla</p>		

#### OPTICAL RESULTS (MEASURED):

##### LUMILEDS

LED LUXEON CX Plus CoB L04 / L05 (Gen2)  
 FWHM / FWTM 23.0° / 41.0°  
 Efficiency 93 %  
 Peak intensity 4.6 cd/lm  
 LEDs/each optic 1  
 Light colour White  
 Required components:  
 Bender Wirth: 637a Hekla

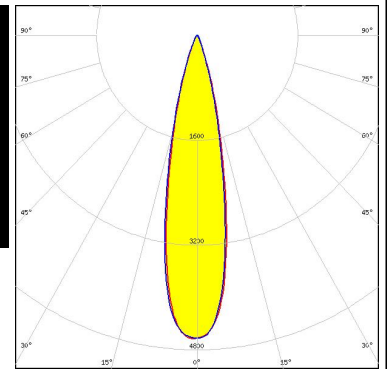
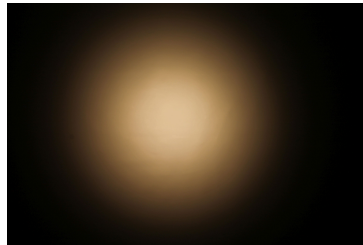

##### LUMILEDS

LED LUXEON CX Plus CoB M02 / M03 (Gen2)  
 FWHM / FWTM 17.0° / 32.0°  
 Efficiency 93 %  
 Peak intensity 7.9 cd/lm  
 LEDs/each optic 1  
 Light colour White  
 Required components:  
 Bender Wirth: 641a Hekla

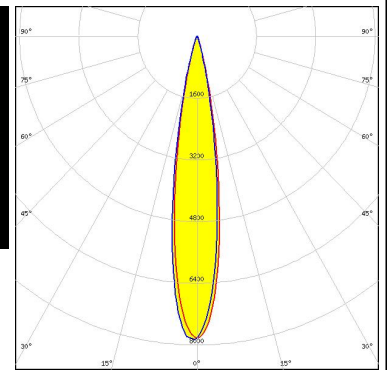

##### LUMILEDS

LED LUXEON CX Plus CoB S01 (Gen2)  
 FWHM / FWTM 12.0° / 23.0°  
 Efficiency 93 %  
 Peak intensity 14.5 cd/lm  
 LEDs/each optic 1  
 Light colour White  
 Required components:  
 Bender Wirth: 634c Hekla

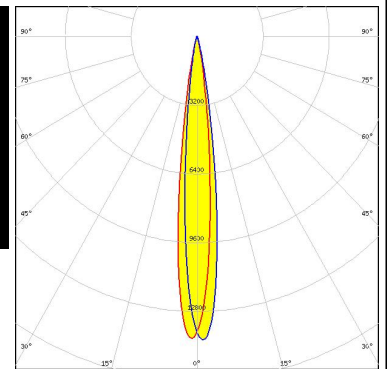
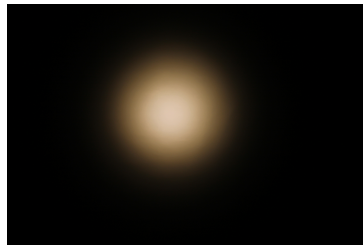





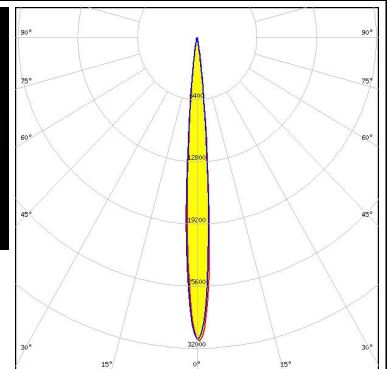
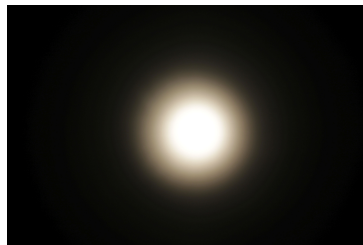

##### LUMINUS

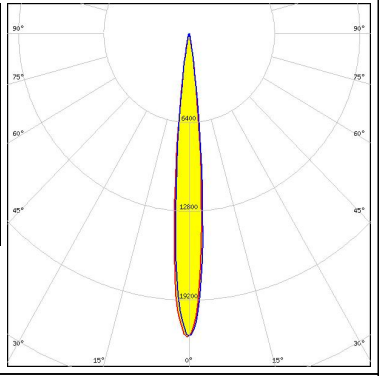

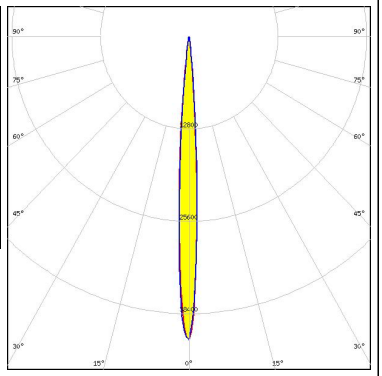

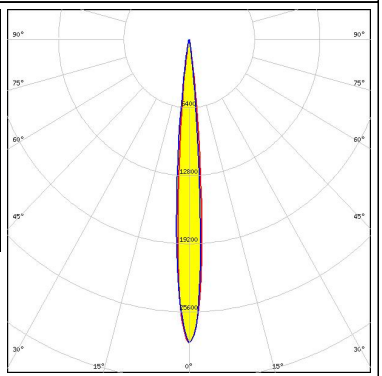

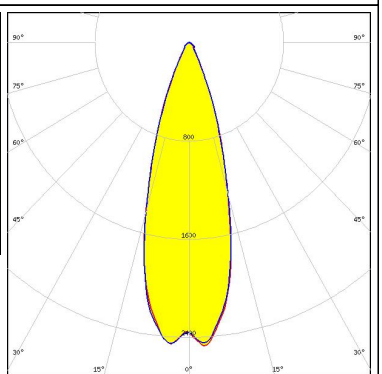
LED CXM-3  
 FWHM / FWTM 9.0° / 16.0°  
 Efficiency 94 %  
 Peak intensity 31.3 cd/lm  
 LEDs/each optic 1  
 Light colour White  
 Required components:  
 F15255\_HEKLA-SOCKET-C

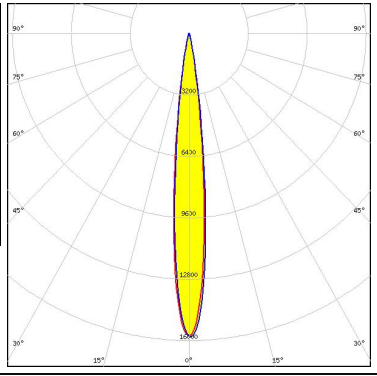

### OPTICAL RESULTS (MEASURED):

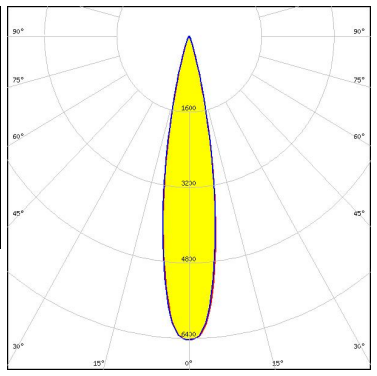
<p><b>LUMINUS</b></p> <p>LED CXM-4            FWHM / FWTM 10.0° / 19.0°            Efficiency 94 %            Peak intensity 21.9 cd/lm            LEDs/each optic 1            Light colour White            Required components:            F15255_HEKLA-SOCKET-C</p>		
<p><b>OSRAM</b> Opto Semiconductors</p> <p>LED OSTAR Stage (S2WN)            FWHM / FWTM 7.0° / 13.0°            Efficiency 94 %            Peak intensity 42.7 cd/lm            LEDs/each optic 1            Light colour White            Required components:            F15859_HEKLA-SOCKET-I</p>		
<p><b>OSRAM</b> Opto Semiconductors</p> <p>LED OSTAR Stage (S2WP)            FWHM / FWTM 9.0° / 16.0°            Efficiency 94 %            Peak intensity 29.2 cd/lm            LEDs/each optic 1            Light colour White            Required components:            F15859_HEKLA-SOCKET-I</p>		
<p><b>SEOUL SEMICONDUCTOR</b></p> <p>LED MJT COB LES 14.5            FWHM / FWTM 31.0° / 55.0°            Efficiency 94 %            Peak intensity 2.5 cd/lm            LEDs/each optic 1            Light colour White            Required components:            F17438_HEKLA-G2-I</p>		

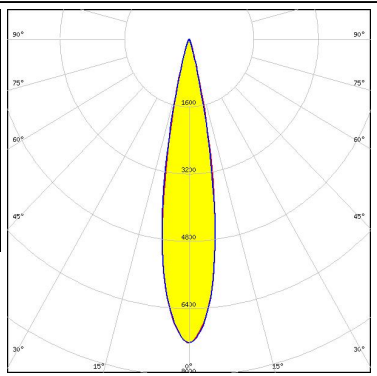
#### OPTICAL RESULTS (MEASURED):

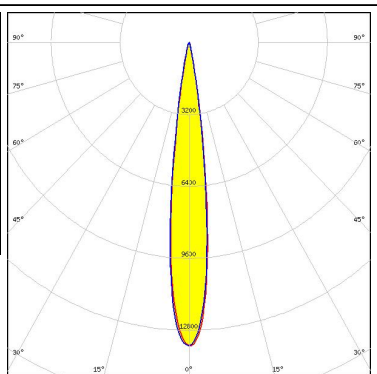
<p><b>SEOL</b> SEOUL SEMICONDUCTOR</p> <p>LED MJT COB LES 6 FWHM / FWTM 12.0° / 22.0° Efficiency 95 % Peak intensity 15.8 cd/lm LEDs/each optic 1 Light colour White Required components: F17435_HEKLA-G2-C</p>		
<p><b>SEOL</b> SEOUL SEMICONDUCTOR</p> <p>LED MJT COB LES 9.8 FWHM / FWTM 20.0° / 34.0° Efficiency 95 % Peak intensity 6.4 cd/lm LEDs/each optic 1 Light colour White Required components: F17435_HEKLA-G2-C</p>		
<p><b>TRIDONIC</b></p> <p>LED SLE G7 LES09 FWHM / FWTM 20.0° / 32.0° Efficiency 95 % Peak intensity 7.2 cd/lm LEDs/each optic 1 Light colour White Required components: F15255_HEKLA-SOCKET-C</p>		
<p><b>XICATO</b></p> <p>LED XOB 6 mm FWHM / FWTM 14.0° / 23.0° Efficiency 93 % Peak intensity 13.5 cd/lm LEDs/each optic 1 Light colour White Required components: F15255_HEKLA-SOCKET-C</p>		







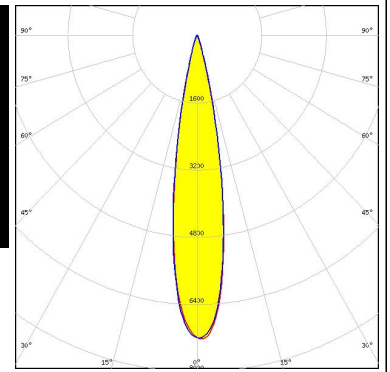

### OPTICAL RESULTS (MEASURED):

#### XICATO

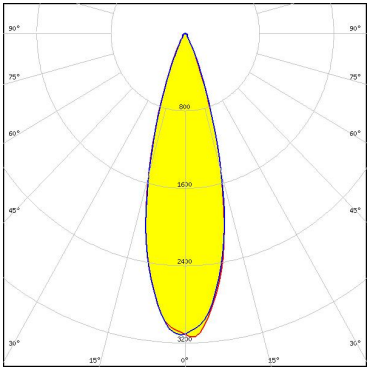
LED	XOB 9.8 mm
FWHM / FWTM	19.0° / 32.0°
Efficiency	94 %
Peak intensity	7.2 cd/lm
LEDs/each optic	1
Light colour	White
Required components:	
	F15255_HEKLA-SOCKET-C

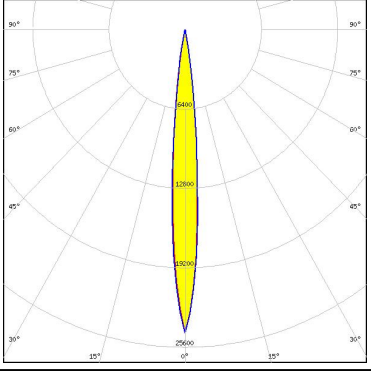

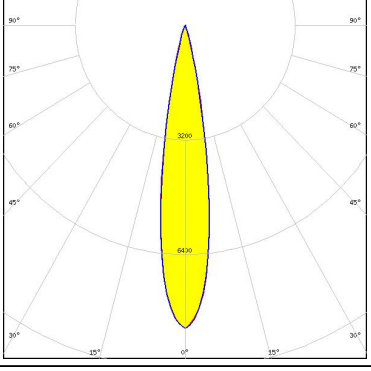
### OPTICAL RESULTS (SIMULATED):

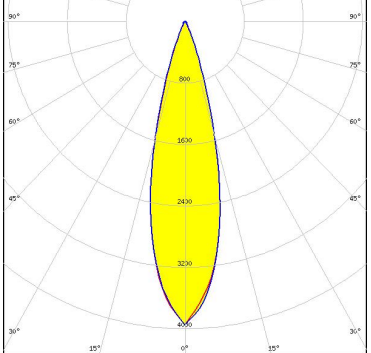
<p></p> <p>LED V13 Gen 8            FWHM / FWTM 30.0° / 50.0°            Efficiency 93 %            Peak intensity 3.1 cd/lm            LEDs/each optic 1            Light colour White            Required components:            F15859_HEKLA-SOCKET-I</p>	
<p></p> <p>LED V4 HD Gen 7            FWHM / FWTM 10.0° / 20.0°            Efficiency 95 %            Peak intensity 24.4 cd/lm            LEDs/each optic 1            Light colour White            Required components:            F15253_HEKLA-SOCKET-A</p>	
<p></p> <p>LED V9 HD Gen7            FWHM / FWTM 18.0° / 30.0°            Efficiency 94 %            Peak intensity 8.5 cd/lm            LEDs/each optic 1            Light colour White            Required components:            F15859_HEKLA-SOCKET-I</p>	
<p></p> <p>LED Vero SE 10            FWHM / FWTM 16.0° / 34.0°            Efficiency 94 %            Peak intensity 7.6 cd/lm            LEDs/each optic 1            Light colour White            Required components:</p>	

#### OPTICAL RESULTS (SIMULATED):

### CITIZEN

LED CLL02x/CLU02x (LES10)  
 FWHM / FWTM 18.0° / 33.0°  
 Efficiency 92 %  
 Peak intensity 7.8 cd/lm  
 LEDs/each optic 1  
 Light colour White  
 Required components:  
 F15255\_HEKLA-SOCKET-C

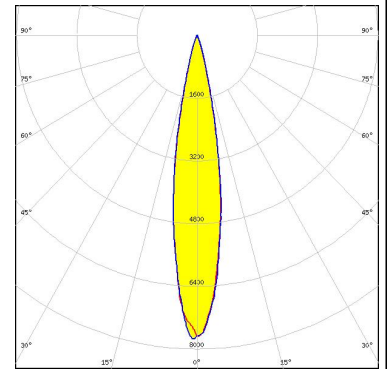

### CITIZEN

LED CLU710/711  
 FWHM / FWTM 17.0° / 30.0°  
 Efficiency 92 %  
 Peak intensity 9.3 cd/lm  
 LEDs/each optic 1  
 Light colour White  
 Required components:  
 F15859\_HEKLA-SOCKET-I

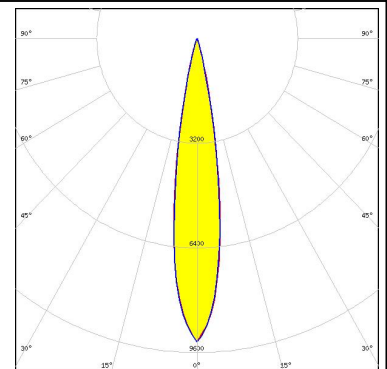

### CITIZEN

LED CLU712/713  
 FWHM / FWTM 18.0° / 31.0°  
 Efficiency 94 %  
 Peak intensity 8.2 cd/lm  
 LEDs/each optic 1  
 Light colour White  
 Required components:  
 F17438\_HEKLA-G2-I

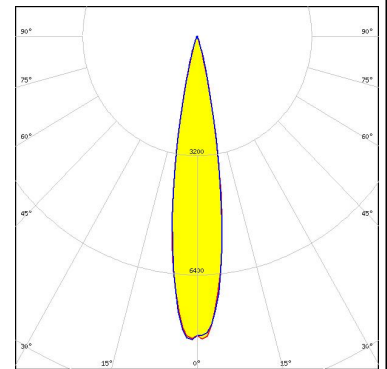

LED CHA0304  
 FWHM / FWTM 9.0° / 18.0°  
 Efficiency 95 %  
 Peak intensity 27.4 cd/lm  
 LEDs/each optic 1  
 Light colour White  
 Required components:  
 F17435\_HEKLA-G2-C

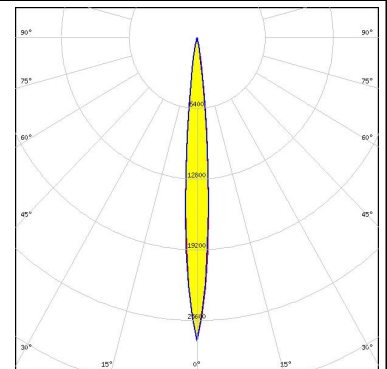

### OPTICAL RESULTS (SIMULATED):



LED CHA0410  
 FWHM / FWTM 10.0° / 20.0°  
 Efficiency 95 %  
 Peak intensity 21.8 cd/lm  
 LEDs/each optic 1  
 Light colour White  
 Required components:  
 F17435\_HEKLA-G2-C

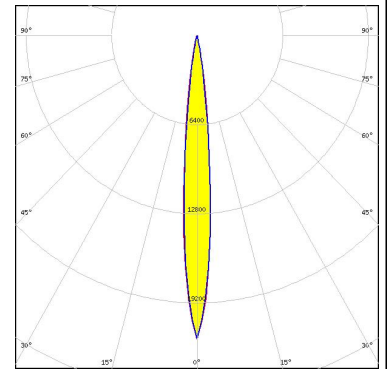

LED CMA1303  
 FWHM / FWTM 10.0° / 20.0°  
 Efficiency 95 %  
 Peak intensity 22.8 cd/lm  
 LEDs/each optic 1  
 Light colour White  
 Required components:  
 F17439\_HEKLA-G2-J

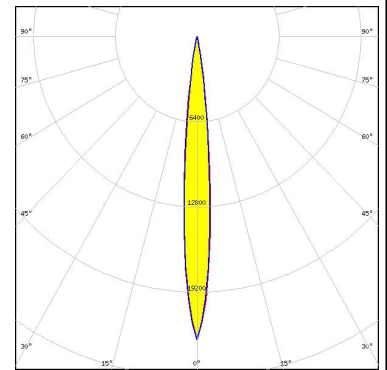

LED CMA1306  
 FWHM / FWTM 12.0° / 24.0°  
 Efficiency 95 %  
 Peak intensity 15.5 cd/lm  
 LEDs/each optic 1  
 Light colour White  
 Required components:  
 F15956\_HEKLA-SOCKET-J

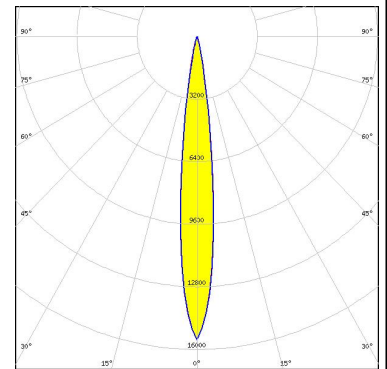

LED CXA/B 13xx  
 FWHM / FWTM 13.0° / 24.0°  
 Efficiency 93 %  
 Peak intensity 15 cd/lm  
 LEDs/each optic 1  
 Light colour White  
 Required components:  
 F15956\_HEKLA-SOCKET-J

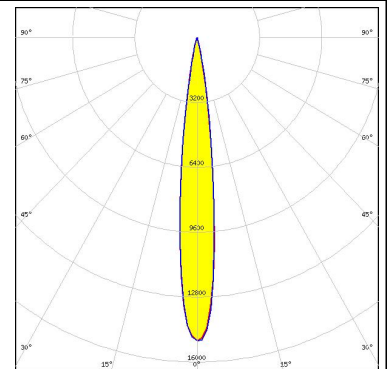

### OPTICAL RESULTS (SIMULATED):



LED CXA/B 15xx  
 FWHM / FWTM 20.0° / 32.0°  
 Efficiency 92 %  
 Peak intensity 7.4 cd/lm  
 LEDs/each optic 1  
 Light colour White  
 Required components:  
 F17436\_HEKLA-G2-D

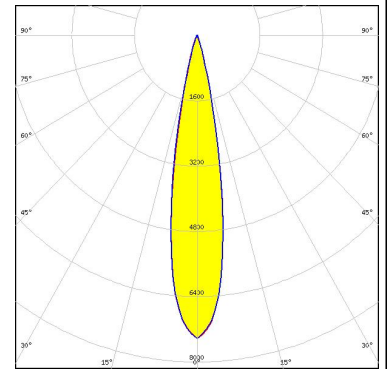

LED CXA/B 15xx  
 FWHM / FWTM 19.0° / 32.0°  
 Efficiency 93 %  
 Peak intensity 7.6 cd/lm  
 LEDs/each optic 1  
 Light colour White  
 Required components:  
 F15256\_HEKLA-SOCKET-D

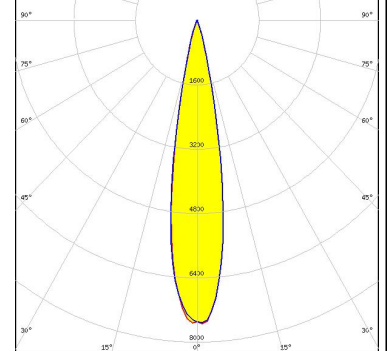

LED CXA/B 1816 & CXA/B 1820 & CXA 1850  
 FWHM / FWTM 23.0° / 40.0°  
 Efficiency 93 %  
 Peak intensity 4.4 cd/lm  
 LEDs/each optic 1  
 Light colour White  
 Required components:  
 F15254\_HEKLA-SOCKET-B

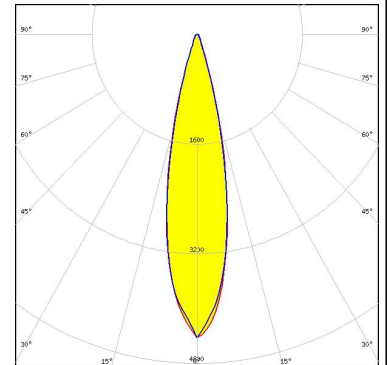

LED LUXEON CoB 1202/1203  
 FWHM / FWTM 18.0° / 33.0°  
 Efficiency 93 %  
 Peak intensity 7.4 cd/lm  
 LEDs/each optic 1  
 Light colour White  
 Required components:  
 F17437\_HEKLA-G2-H

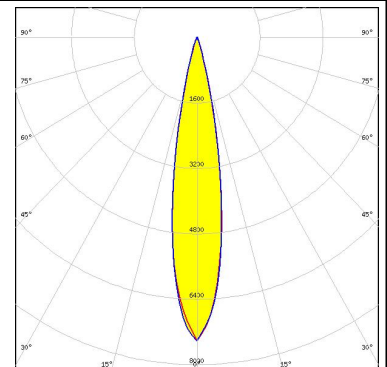

#### OPTICAL RESULTS (SIMULATED):

<p><b>LUMILEDS</b></p> <p>LED LUXEON CoB 1202s</p> <p>FWHM / FWTM 12.0° / 24.0°</p> <p>Efficiency 95 %</p> <p>Peak intensity 15.6 cd/lm</p> <p>LEDs/each optic 1</p> <p>Light colour White</p> <p>Required components: F15858_HEKLA-SOCKET-H</p>	
<p><b>LUMILEDS</b></p> <p>LED LUXEON CoB 1204/1205</p> <p>FWHM / FWTM 26.0° / 44.0°</p> <p>Efficiency 94 %</p> <p>Peak intensity 3.9 cd/lm</p> <p>LEDs/each optic 1</p> <p>Light colour White</p> <p>Required components:</p>	
<p><b>LUMILEDS</b></p> <p>LED LUXEON CoB 1204HD</p> <p>FWHM / FWTM 20.0° / 32.0°</p> <p>Efficiency 94 %</p> <p>Peak intensity 7.7 cd/lm</p> <p>LEDs/each optic 1</p> <p>Light colour White</p> <p>Required components: F17437_HEKLA-G2-H</p>	
<p><b>LUMILEDS</b></p> <p>LED LUXEON CoB 1205HD</p> <p>FWHM / FWTM 24.0° / 39.0°</p> <p>Efficiency 94 %</p> <p>Peak intensity 5 cd/lm</p> <p>LEDs/each optic 1</p> <p>Light colour White</p> <p>Required components: F17437_HEKLA-G2-H</p>	

### OPTICAL RESULTS (SIMULATED):

#### LUMILEDS

LED LUXEON CoB 1208  
 FWHM / FWTM 27.0° / 50.0°  
 Efficiency 91 %  
 Peak intensity 3.2 cd/lm  
 LEDs/each optic 1  
 Light colour White  
 Required components:  
 C16142\_HEKLA-SOCKET-K

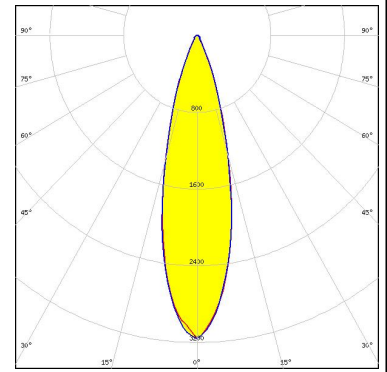

#### LUMINUS

LED CxM-6 (13.5x13.5)  
 FWHM / FWTM 14.0° / 25.0°  
 Efficiency 94 %  
 Peak intensity 13.4 cd/lm  
 LEDs/each optic 1  
 Light colour White  
 Required components:  
 F15255\_HEKLA-SOCKET-C

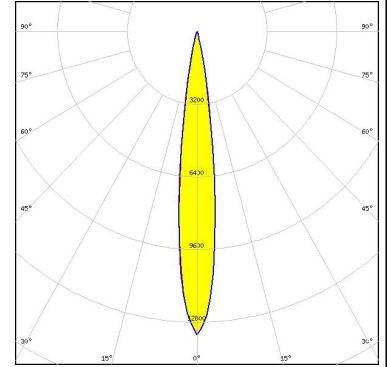

#### NICHIA

LED COB S-Type (LES 6)  
 FWHM / FWTM 12.0° / 24.0°  
 Efficiency 93 %  
 Peak intensity 15.4 cd/lm  
 LEDs/each optic 1  
 Light colour White  
 Required components:  
 F15848\_HEKLA-SOCKET-G

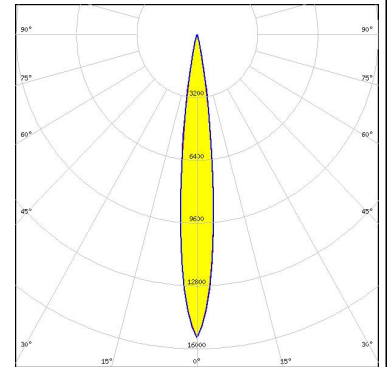

#### NICHIA

LED COB S-Type (LES 6)  
 FWHM / FWTM 12.0° / 24.0°  
 Efficiency 93 %  
 Peak intensity 15.6 cd/lm  
 LEDs/each optic 1  
 Light colour White  
 Required components:  
 F15848\_HEKLA-SOCKET-G

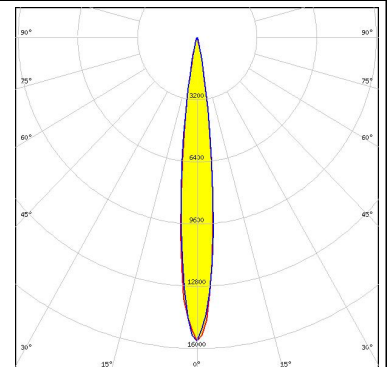

### OPTICAL RESULTS (SIMULATED):

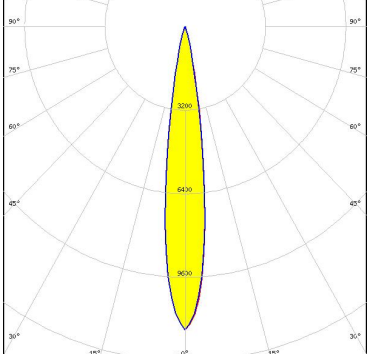
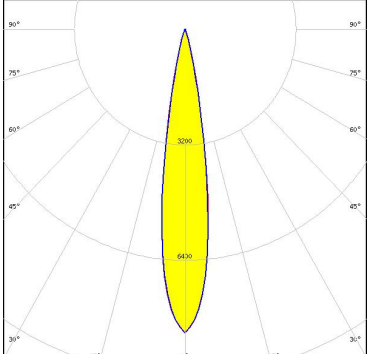
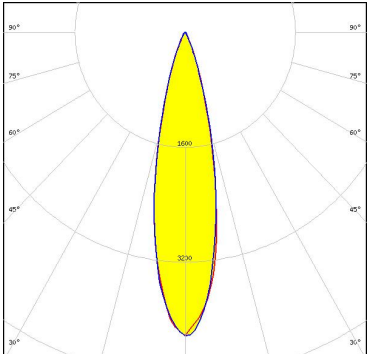
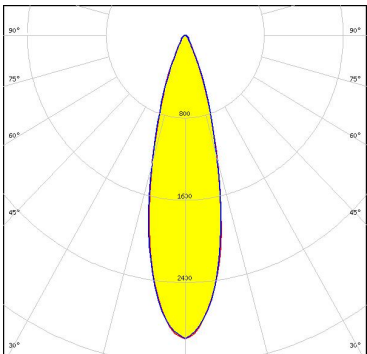
<p><b>NICHIA</b></p> <p>LED COB S-Type (LES 7)</p> <p>FWHM / FWTM 16.0° / 26.0°</p> <p>Efficiency 95 %</p> <p>Peak intensity 11.6 cd/lm</p> <p>LEDs/each optic 1</p> <p>Light colour White</p> <p>Required components: F15848_HEKLA-SOCKET-G</p>	
<p><b>NICHIA</b></p> <p>LED NFSWE11A</p> <p>FWHM / FWTM 18.0° / 30.0°</p> <p>Efficiency 88 %</p> <p>Peak intensity 8.4 cd/lm</p> <p>LEDs/each optic 30</p> <p>Light colour White</p> <p>Required components: C16142_HEKLA-SOCKET-K</p>	
<p><b>PHILIPS</b></p> <p>LED Fortimo SLM L13 CoB</p> <p>FWHM / FWTM 24.0° / 44.0°</p> <p>Efficiency 93 %</p> <p>Peak intensity 4.2 cd/lm</p> <p>LEDs/each optic 1</p> <p>Light colour White</p> <p>Required components: Bender Wirth: 632a Hekla XL</p>	
<p><b>PHILIPS</b></p> <p>LED Fortimo SLM L15 CoB</p> <p>FWHM / FWTM 28.0° / 52.0°</p> <p>Efficiency 92 %</p> <p>Peak intensity 3 cd/lm</p> <p>LEDs/each optic 1</p> <p>Light colour White</p> <p>Required components: Bender Wirth: 632a Hekla XL</p>	



### OPTICAL RESULTS (SIMULATED):

#### PHILIPS

LED Fortimo SLM L15 CoB  
 FWHM / FWTM 26.0° / 50.0°  
 Efficiency 93 %  
 Peak intensity 3.3 cd/lm  
 LEDs/each optic 1  
 Light colour White  
 Required components:  
 Bender Wirth: 632a Hekla XL

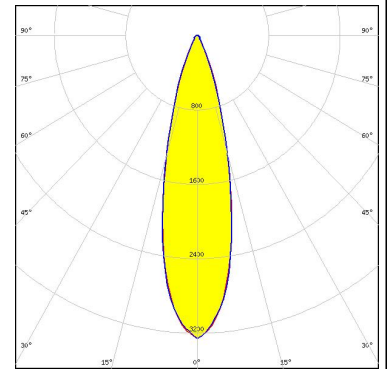

#### SAMSUNG

LED LC010C  
 FWHM / FWTM 14.0° / 24.0°  
 Efficiency 94 %  
 Peak intensity 14.4 cd/lm  
 LEDs/each optic 1  
 Light colour White  
 Required components:  
 F15848\_HEKLA-SOCKET-G

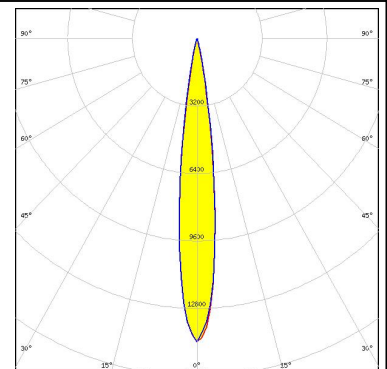

#### SAMSUNG

LED LC020C  
 FWHM / FWTM 14.0° / 24.0°  
 Efficiency 94 %  
 Peak intensity 13.5 cd/lm  
 LEDs/each optic 1  
 Light colour White  
 Required components:  
 F17438\_HEKLA-G2-I

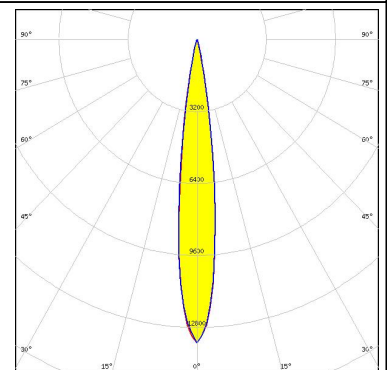

#### XICATO

LED XTM - 9mm LES  
 FWHM / FWTM 18.0° / 32.0°  
 Efficiency 94 %  
 Peak intensity 8.3 cd/lm  
 LEDs/each optic 1  
 Light colour White  
 Required components:  
 C15743\_XTM-ADAPTER-50-B

