

ILONA-M

~25° wide beam

SPECIFICATION:

Dimensions	Ø 49.8 mm
Height	29.7 mm
Fastening	socket
ROHS compliant	yes ⓘ

MATERIALS:

Component	Type	Material	Colour	Finish
ILONA-M	Single lens	PMMA	clear	







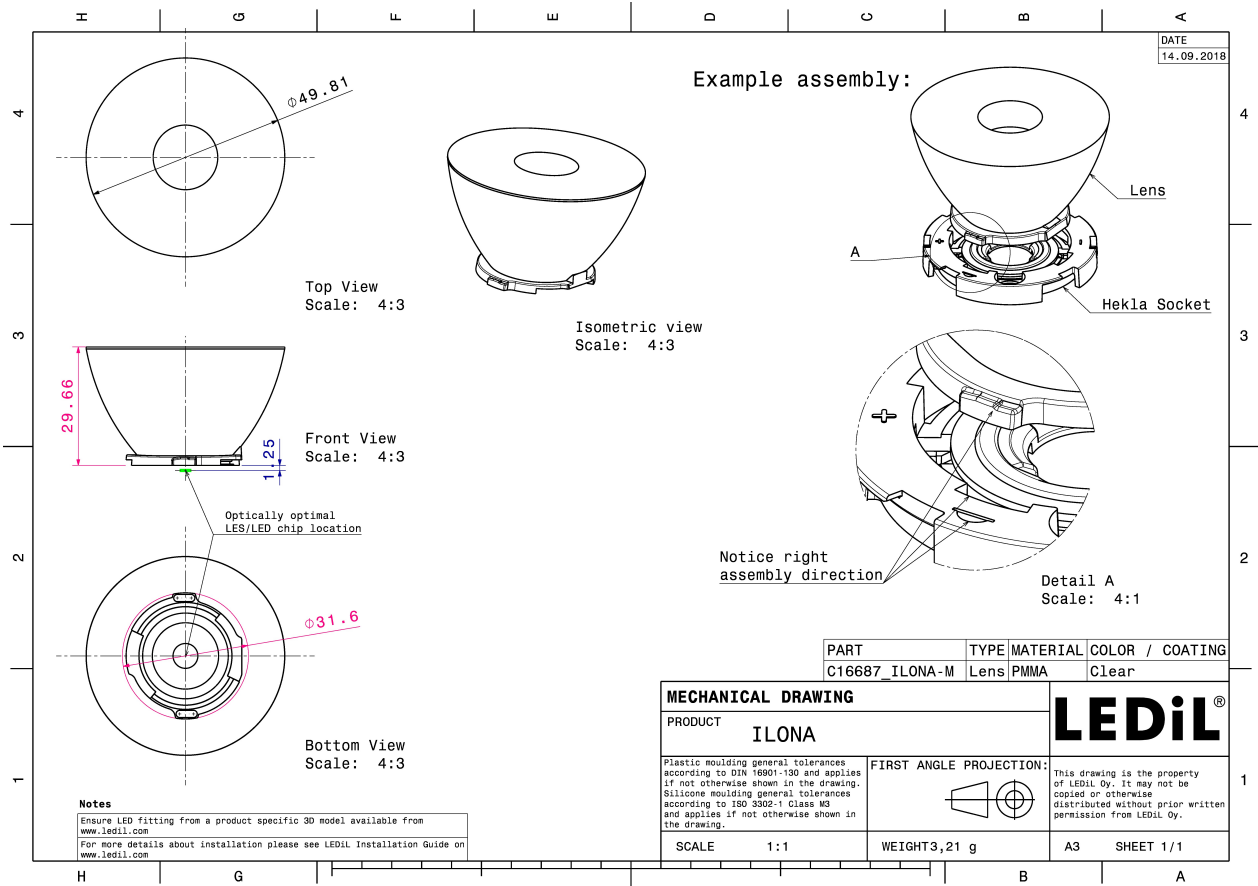



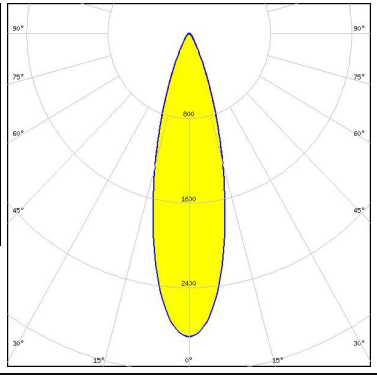

ORDERING INFORMATION:

Component	Qty in box	MOQ	MPQ	Box weight (kg)
C16687_ILONA-M » Box size: 480 x 280 x 300 mm	264	99	33	9.9

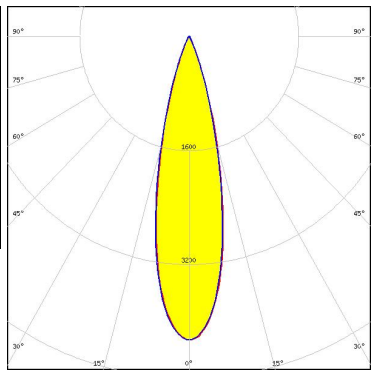

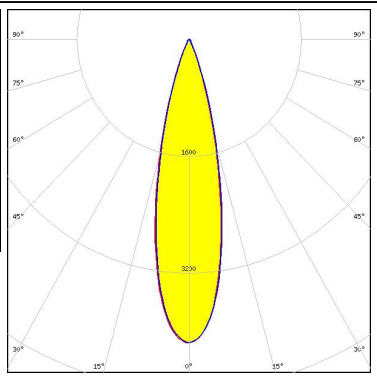
See also our general installation guide: www.ledil.com/installation_guide

OPTICAL RESULTS (MEASURED):

<p></p> <p>LED V11 HD Gen 8 FWHM / FWTM 28.0° / 53.0° Efficiency 92 % Peak intensity 2.9 cd/m LEDs/each optic 1 Light colour White Required components: Bender Wirth: 633d Hekla</p>		
<p></p> <p>LED V6 HD Gen 7 FWHM / FWTM 25.0° / 44.0° Efficiency 95 % Peak intensity 4.3 cd/m LEDs/each optic 1 Light colour White Required components: F15255_HEKLA-SOCKET-C</p>		
<p></p> <p>LED V6 HD Gen 7 FWHM / FWTM 25.0° / 44.0° Efficiency 95 % Peak intensity 4.2 cd/m LEDs/each optic 1 Light colour White Required components: Bender Wirth: 634c Hekla</p>		
<p></p> <p>LED Vesta DTW 13mm (21W) FWHM / FWTM 31.0° / 61.0° Efficiency 90 % Peak intensity 2.2 cd/m LEDs/each optic 1 Light colour Tunable White Required components: C16142_HEKLA-SOCKET-K Bender Wirth: 491 Typ L8</p>		

OPTICAL RESULTS (MEASURED):



LED Vesta DTW 9mm (4W/6W/12W)
 FWHM / FWTM 25.0° / 48.0°
 Efficiency 93 %
 Peak intensity 3.6 cd/lm
 LEDs/each optic 1
 Light colour White
 Required components:
 C16142_HEKLA-SOCKET-K
 Bender Wirth: 490 Typ L8

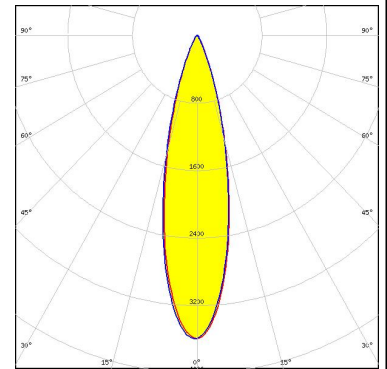

LED Vesta TW 6mm DP
 FWHM / FWTM 26.0° / 45.0°
 Efficiency 91 %
 Peak intensity 3.9 cd/lm
 LEDs/each optic 1
 Light colour White
 Required components:
 C16142_HEKLA-SOCKET-K
 Bender Wirth: 504 Typ L8

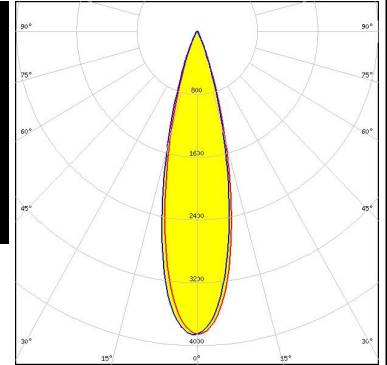
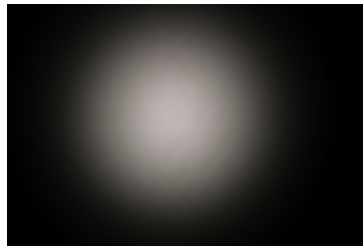

CITIZEN

LED CLU7A2/7A3
 FWHM / FWTM 25.0° / 41.0°
 Efficiency 94 %
 Peak intensity 4.7 cd/lm
 LEDs/each optic 1
 Light colour White
 Required components:
 F15255_HEKLA-SOCKET-C

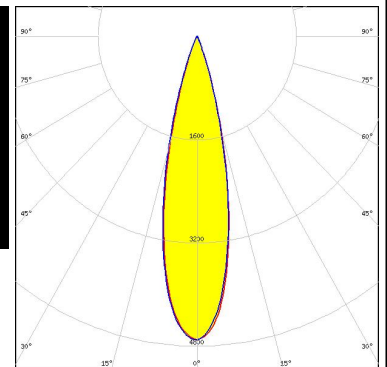



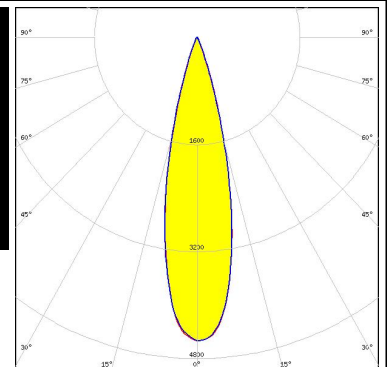
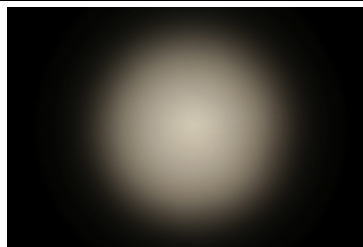

CITIZEN



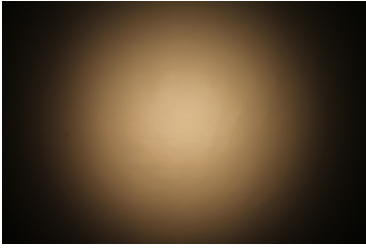
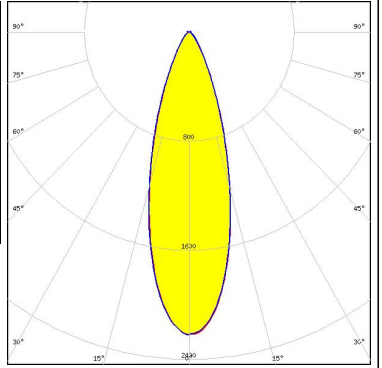
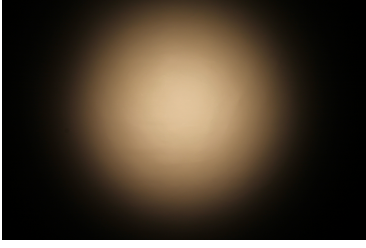
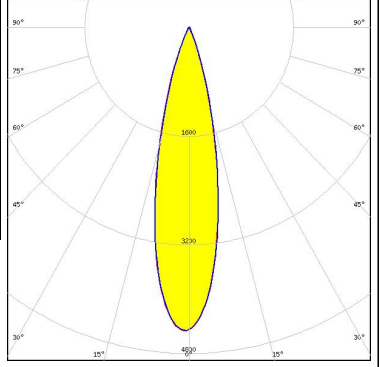

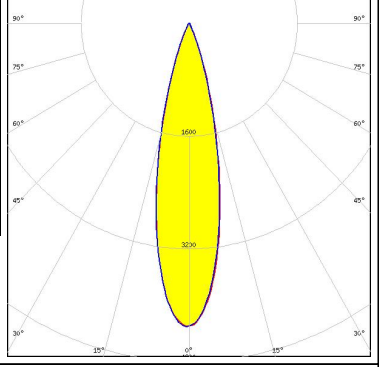

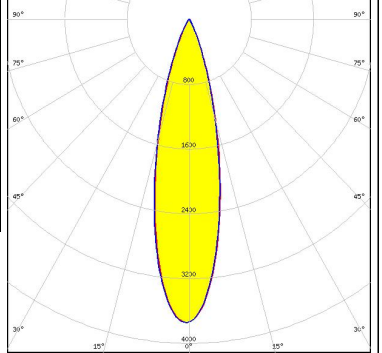
LED CLU7B2
 FWHM / FWTM 25.0° / 41.0°
 Efficiency 94 %
 Peak intensity 4.5 cd/lm
 LEDs/each optic 1
 Light colour White
 Required components:
 F15255_HEKLA-SOCKET-C

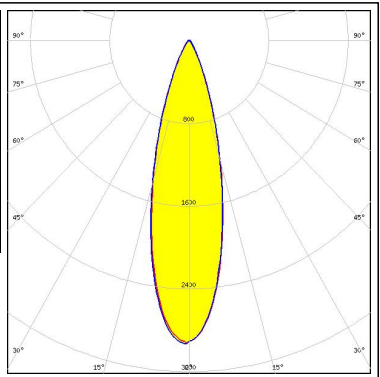

OPTICAL RESULTS (MEASURED):

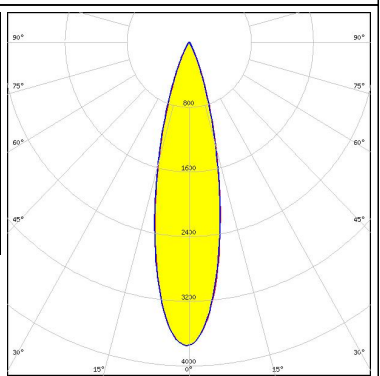
<p>LUMILEDS</p> <p>LED LUXEON CX Plus CoB L08 (Gen2)</p> <p>FWHM / FWTM 32.0° / 62.0°</p> <p>Efficiency 92 %</p> <p>Peak intensity 2.2 cd/m</p> <p>LEDs/each optic 1</p> <p>Light colour White</p> <p>Required components: Bender Wirth: 637a Hekla</p>		
<p>LUMILEDS</p> <p>LED LUXEON CX Plus CoB - HD S01H4</p> <p>FWHM / FWTM 25.0° / 43.0°</p> <p>Efficiency 94 %</p> <p>Peak intensity 4.5 cd/m</p> <p>LEDs/each optic 1</p> <p>Light colour White</p> <p>Required components: Bender Wirth: 634c Hekla</p>		
<p>LUMILEDS</p> <p>LED LUXEON CX Plus CoB - HD S02H6</p> <p>FWHM / FWTM 25.0° / 44.0°</p> <p>Efficiency 94 %</p> <p>Peak intensity 4.3 cd/m</p> <p>LEDs/each optic 1</p> <p>Light colour White</p> <p>Required components: Bender Wirth: 634c Hekla</p>		
<p>LUMILEDS</p> <p>LED LUXEON CX Plus CoB - HD S04H9</p> <p>FWHM / FWTM 25.0° / 48.0°</p> <p>Efficiency 94 %</p> <p>Peak intensity 3.8 cd/m</p> <p>LEDs/each optic 1</p> <p>Light colour White</p> <p>Required components: Bender Wirth: 634c Hekla</p>		

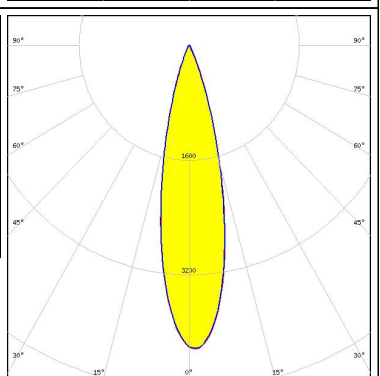
OPTICAL RESULTS (MEASURED):

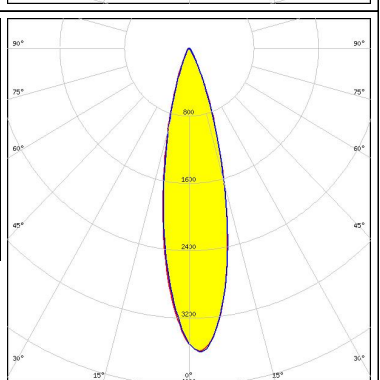
<p>LUMILEDS</p> <p>LED LUXEON CX Plus CoB L04 / L05 (Gen2)</p> <p>FWHM / FWTM 28.0° / 54.0°</p> <p>Efficiency 93 %</p> <p>Peak intensity 2.9 cd/m</p> <p>LEDs/each optic 1</p> <p>Light colour White</p> <p>Required components: Bender Wirth: 637a Hekla</p>		
<p>LUMILEDS</p> <p>LED LUXEON CX Plus CoB M02 / M03 (Gen2)</p> <p>FWHM / FWTM 25.0° / 48.0°</p> <p>Efficiency 94 %</p> <p>Peak intensity 3.8 cd/m</p> <p>LEDs/each optic 1</p> <p>Light colour White</p> <p>Required components: Bender Wirth: 641a Hekla</p>		
<p>LUMILEDS</p> <p>LED LUXEON CX Plus CoB S01 (Gen2)</p> <p>FWHM / FWTM 25.0° / 44.0°</p> <p>Efficiency 94 %</p> <p>Peak intensity 4.3 cd/m</p> <p>LEDs/each optic 1</p> <p>Light colour White</p> <p>Required components: Bender Wirth: 634c Hekla</p>		
<p>LUMILEDS</p> <p>LED LUXEON Fusion 21-up (20x24)</p> <p>FWHM / FWTM 25.0° / 47.0°</p> <p>Efficiency 94 %</p> <p>Peak intensity 3.7 cd/m</p> <p>LEDs/each optic 21</p> <p>Light colour White</p> <p>Required components: C16142_HEKLA-SOCKET-K Bender Wirth: 442 Typ L8</p>		

OPTICAL RESULTS (MEASURED):



LED CXM-3
FWHM / FWTM 25.0° / 41.0°
Efficiency 94 %
Peak intensity 4.6 cd/m
LEDs/each optic 1
Light colour White
Required components:
 F15255_HEKLA-SOCKET-C

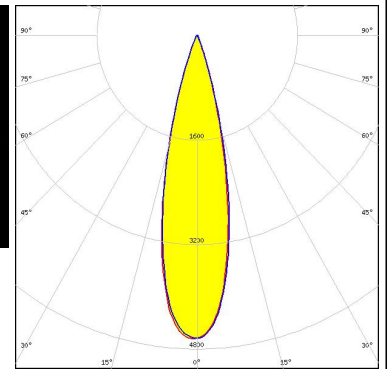

LED CXM-4
FWHM / FWTM 24.0° / 42.0°
Efficiency 92 %
Peak intensity 4.4 cd/m
LEDs/each optic 1
Light colour White
Required components:
 F15255_HEKLA-SOCKET-C

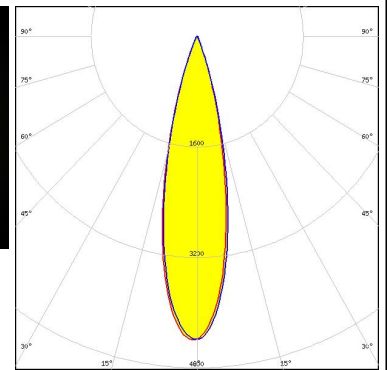

LED OSTAR Stage (S2WN)
FWHM / FWTM 25.0° / 41.0°
Efficiency 94 %
Peak intensity 4.7 cd/m
LEDs/each optic 1
Light colour White
Required components:
 F15859_HEKLA-SOCKET-I

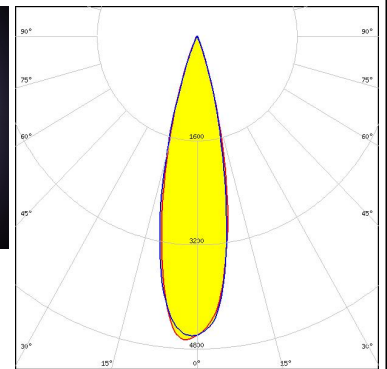
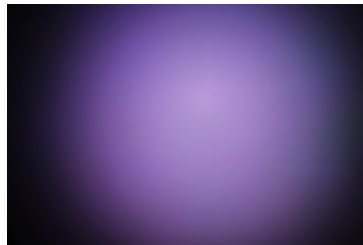

LED OSTAR Stage (S2WP)
FWHM / FWTM 25.0° / 41.0°
Efficiency 94 %
Peak intensity 4.6 cd/m
LEDs/each optic 1
Light colour White
Required components:
 F15859_HEKLA-SOCKET-I

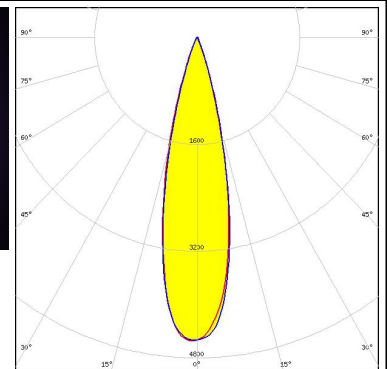
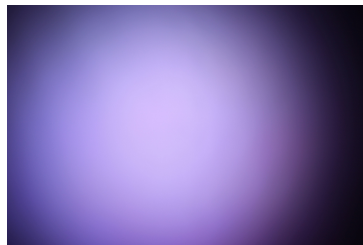

OPTICAL RESULTS (MEASURED):

SAMSUNG

LED LC010T (Tunable White)
 FWHM / FWTM 26.0° / 51.0°
 Efficiency 88 %
 Peak intensity 2.9 cd/lm
 LEDs/each optic 1
 Light colour Tunable White
 Required components:
 C16142_HEKLA-SOCKET-K
 Bender Wirth: 501 Typ L8

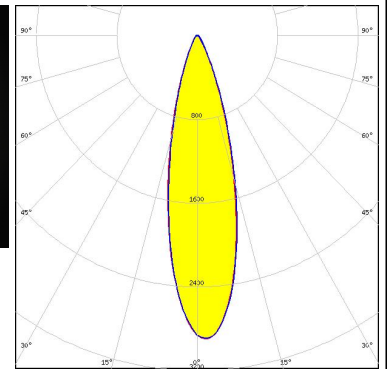
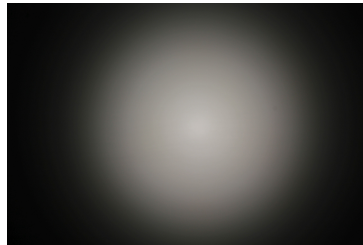

SEOUL SEMICONDUCTOR

LED MJT COB LES 14.5
 FWHM / FWTM 34.0° / 64.0°
 Efficiency 93 %
 Peak intensity 2 cd/lm
 LEDs/each optic 1
 Light colour White
 Required components:
 F17438_HEKLA-G2-I

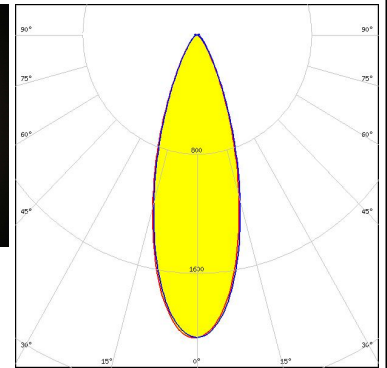
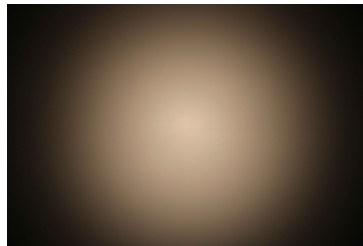

SEOUL SEMICONDUCTOR

LED MJT COB LES 6
 FWHM / FWTM 26.0° / 44.0°
 Efficiency 95 %
 Peak intensity 4.2 cd/lm
 LEDs/each optic 1
 Light colour White
 Required components:
 F17435_HEKLA-G2-C

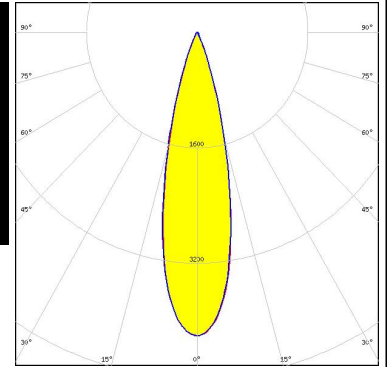
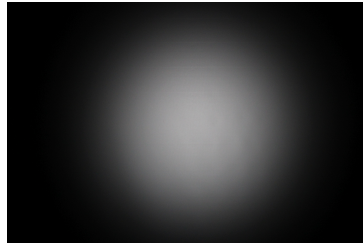

SEOUL SEMICONDUCTOR

LED MJT COB LES 9.8
 FWHM / FWTM 26.0° / 49.0°
 Efficiency 95 %
 Peak intensity 3.6 cd/lm
 LEDs/each optic 1
 Light colour White
 Required components:
 F17435_HEKLA-G2-C

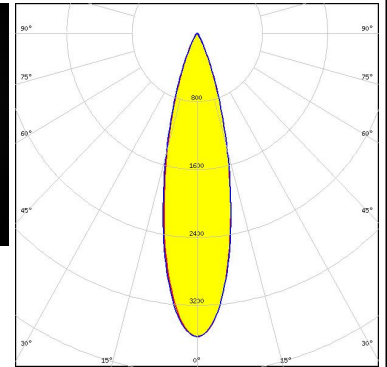
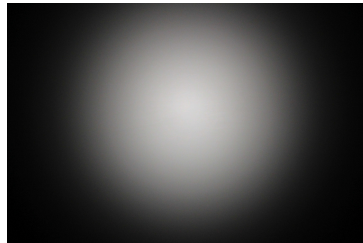

OPTICAL RESULTS (MEASURED):

TRIDONIC

LED SLE G7 LES09
FWHM / FWTM 25.0° / 48.0°
Efficiency 94 %
Peak intensity 3.7 cd/lm
LEDs/each optic 1
Light colour White
Required components:
F15255_HEKLA-SOCKET-C

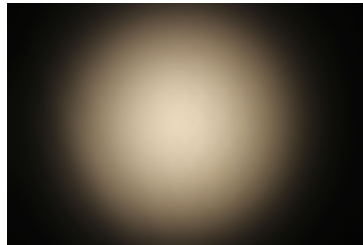

XICATO

LED XOB 6 mm
FWHM / FWTM 24.0° / 44.0°
Efficiency 94 %
Peak intensity 4.4 cd/lm
LEDs/each optic 1
Light colour White
Required components:
F15255_HEKLA-SOCKET-C

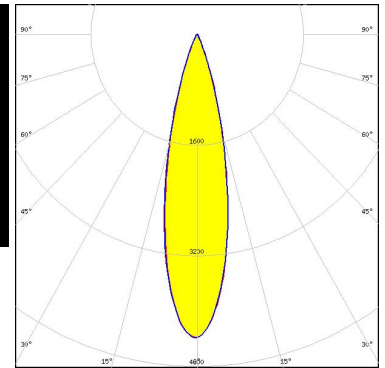
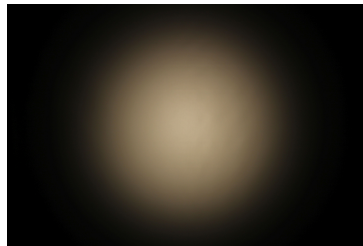





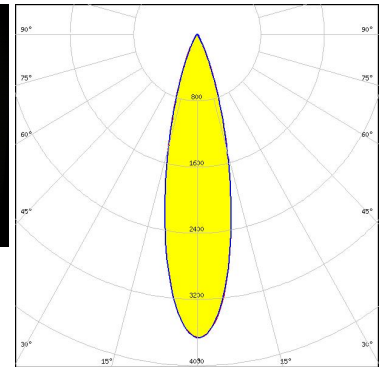
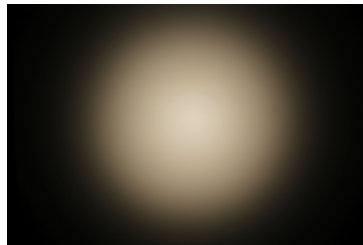

XICATO

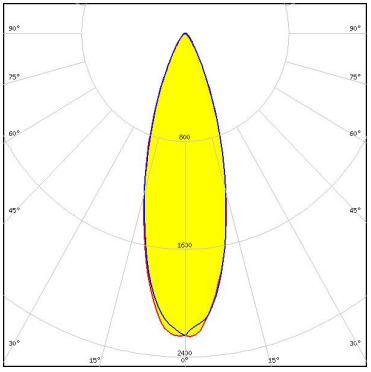
LED XOB 9.8 mm
FWHM / FWTM 26.0° / 48.0°
Efficiency 94 %
Peak intensity 3.7 cd/lm
LEDs/each optic 1
Light colour White
Required components:
F15255_HEKLA-SOCKET-C

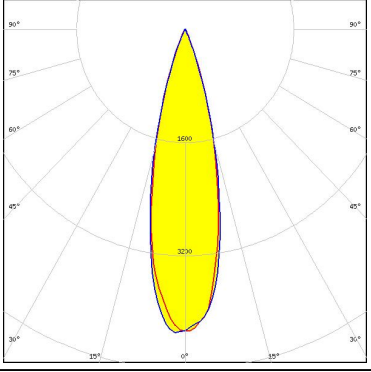

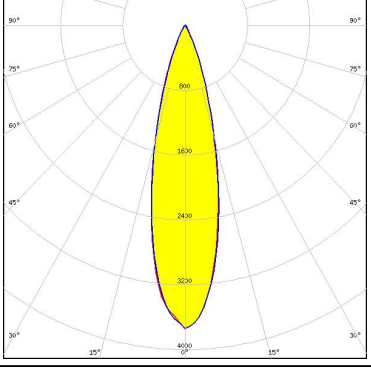
OPTICAL RESULTS (SIMULATED):

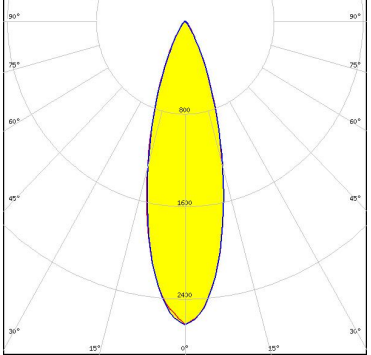
<p></p> <p>LED V13 Gen 8 FWHM / FWTM 32.0° / 61.0° Efficiency 90 % Peak intensity 2.3 cd/lm LEDs/each optic 1 Light colour White Required components: F15859_HEKLA-SOCKET-I</p>	
<p></p> <p>LED V4 HD Gen 7 FWHM / FWTM 26.0° / 44.0° Efficiency 93 % Peak intensity 4.3 cd/lm LEDs/each optic 1 Light colour White Required components: F15253_HEKLA-SOCKET-A</p>	
<p></p> <p>LED V9 HD Gen7 FWHM / FWTM 26.0° / 48.0° Efficiency 93 % Peak intensity 3.7 cd/lm LEDs/each optic 1 Light colour White Required components: F15859_HEKLA-SOCKET-I</p>	
<p></p> <p>LED Vero SE 10 FWHM / FWTM 26.0° / 48.0° Efficiency 93 % Peak intensity 3.7 cd/lm LEDs/each optic 1 Light colour White Required components:</p>	

OPTICAL RESULTS (SIMULATED):

CITIZEN

LED CLL02x/CLU02x (LES10)
 FWHM / FWTM 26.0° / 49.0°
 Efficiency 91 %
 Peak intensity 3.7 cd/lm
 LEDs/each optic 1
 Light colour White
 Required components:
 F15255_HEKLA-SOCKET-C

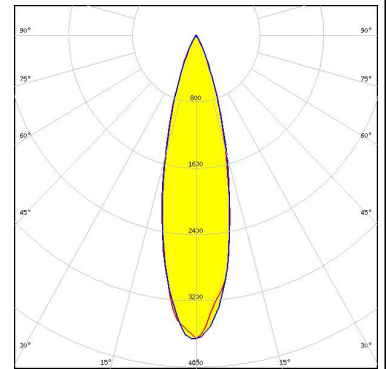

CITIZEN

LED CLU700/701/702/703
 FWHM / FWTM 26.0° / 45.0°
 Efficiency 92 %
 Peak intensity 4.2 cd/lm
 LEDs/each optic 1
 Light colour White
 Required components:
 F15255_HEKLA-SOCKET-C

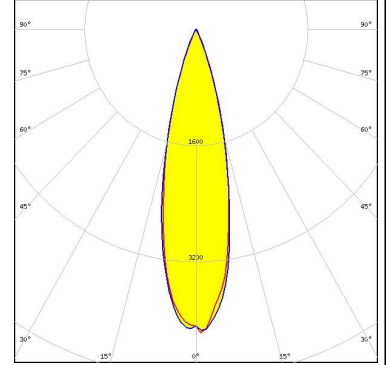

CITIZEN

LED CLU710/711
 FWHM / FWTM 26.0° / 48.0°
 Efficiency 91 %
 Peak intensity 3.8 cd/lm
 LEDs/each optic 1
 Light colour White
 Required components:
 F15859_HEKLA-SOCKET-I

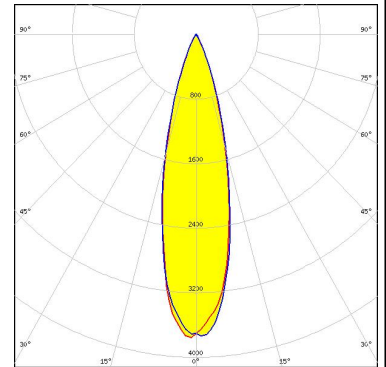

CITIZEN

LED CLU712/713
 FWHM / FWTM 28.0° / 50.0°
 Efficiency 94 %
 Peak intensity 3.5 cd/lm
 LEDs/each optic 1
 Light colour White
 Required components:
 F17438_HEKLA-G2-I

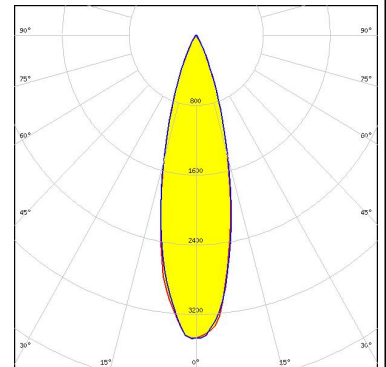

OPTICAL RESULTS (SIMULATED):



LED: CHA0304
 FWHM / FWTM: 25.0° / 42.0°
 Efficiency: 94 %
 Peak intensity: 4.6 cd/lm
 LEDs/each optic: 1
 Light colour: White
 Required components:
 F17435_HEKLA-G2-C

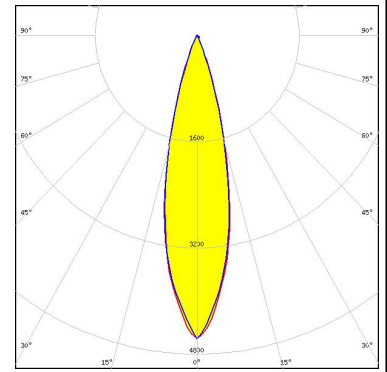

LED: CHA0410
 FWHM / FWTM: 26.0° / 44.0°
 Efficiency: 94 %
 Peak intensity: 4.4 cd/lm
 LEDs/each optic: 1
 Light colour: White
 Required components:
 F17435_HEKLA-G2-C

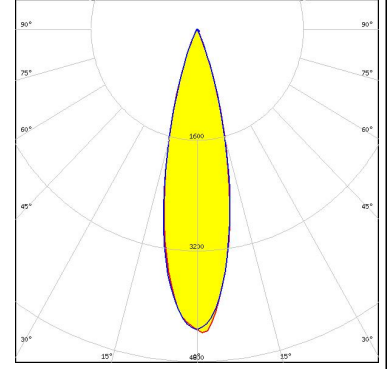

LED: CMA1825
 FWHM / FWTM: 30.0° / 56.0°
 Efficiency: 91 %
 Peak intensity: 2.7 cd/lm
 LEDs/each optic: 1
 Light colour: White
 Required components:
 F15254_HEKLA-SOCKET-B

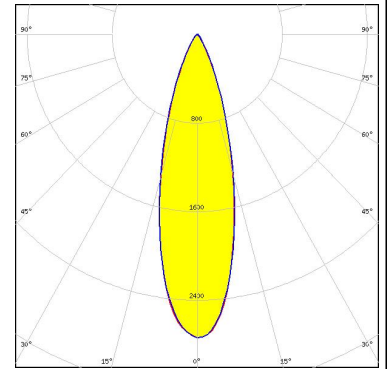

LED: CXA/B 13xx
 FWHM / FWTM: 25.0° / 45.0°
 Efficiency: 91 %
 Peak intensity: 4.2 cd/lm
 LEDs/each optic: 1
 Light colour: White
 Required components:
 F15956_HEKLA-SOCKET-J

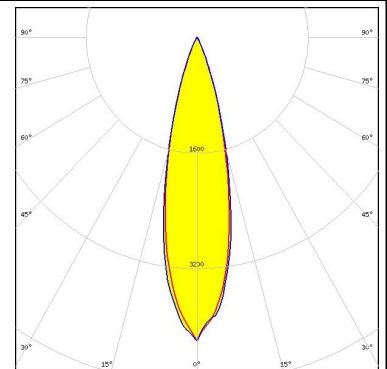

OPTICAL RESULTS (SIMULATED):



LED CXA/B 15xx
 FWHM / FWTM 26.0° / 49.0°
 Efficiency 92 %
 Peak intensity 3.6 cd/lm
 LEDs/each optic 1
 Light colour White
 Required components:
 F15256_HEKLA-SOCKET-D

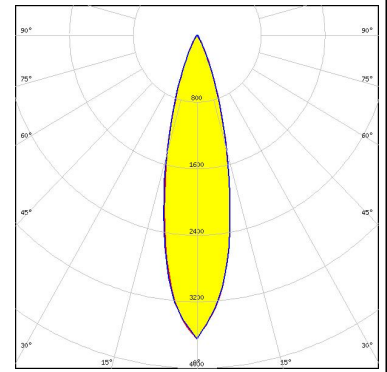

LED CXA/B 1816 & CXA/B 1820 & CXA 1850
 FWHM / FWTM 28.0° / 55.0°
 Efficiency 94 %
 Peak intensity 2.9 cd/lm
 LEDs/each optic 1
 Light colour White
 Required components:
 F15254_HEKLA-SOCKET-B

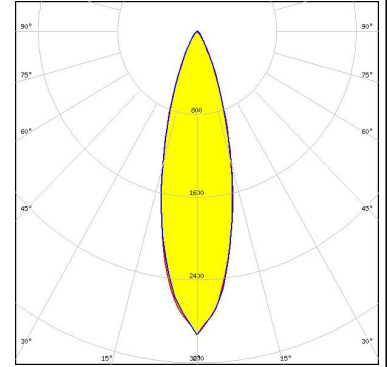

LED LUXEON CoB 1202/1203
 FWHM / FWTM 26.0° / 50.0°
 Efficiency 92 %
 Peak intensity 3.7 cd/lm
 LEDs/each optic 1
 Light colour White
 Required components:
 F17437_HEKLA-G2-H

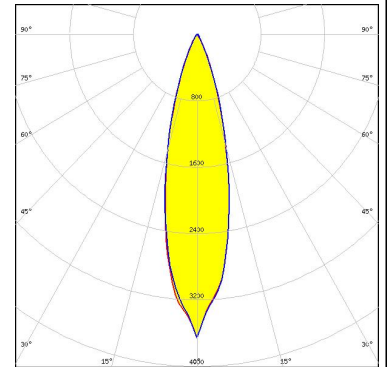

LED LUXEON CoB 1202s
 FWHM / FWTM 26.0° / 48.0°
 Efficiency 95 %
 Peak intensity 3.8 cd/lm
 LEDs/each optic 1
 Light colour White
 Required components:

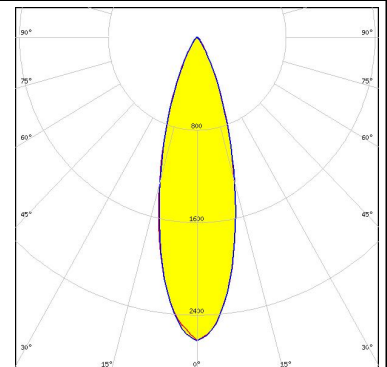

OPTICAL RESULTS (SIMULATED):

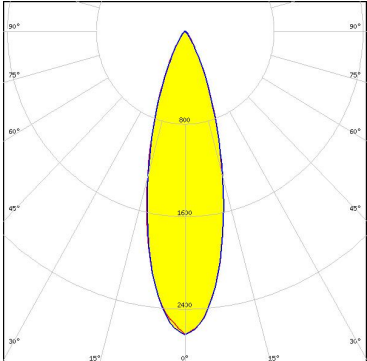
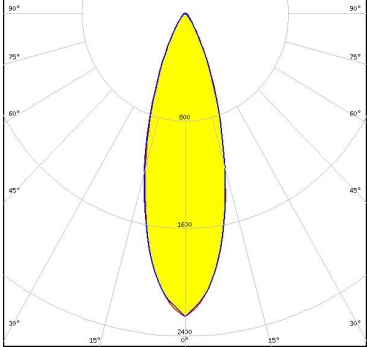
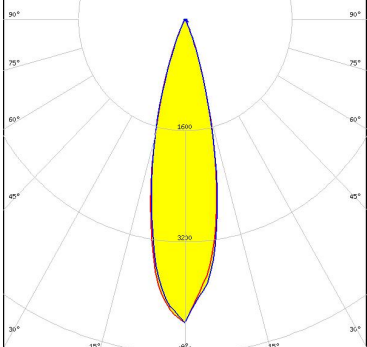
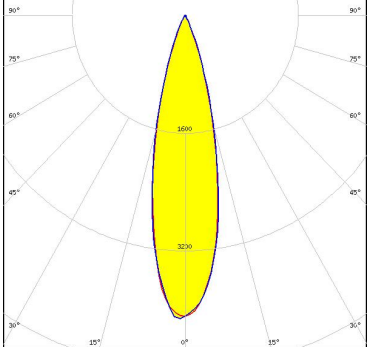
<p>LUMILEDS</p> <p>LED LUXEON CoB 1204/1205</p> <p>FWHM / FWTM 30.0° / 58.0°</p> <p>Efficiency 91 %</p> <p>Peak intensity 2.6 cd/lm</p> <p>LEDs/each optic 1</p> <p>Light colour White</p> <p>Required components:</p>	
<p>LUMILEDS</p> <p>LED LUXEON CoB 1208</p> <p>FWHM / FWTM 32.0° / 60.0°</p> <p>Efficiency 88 %</p> <p>Peak intensity 2.3 cd/lm</p> <p>LEDs/each optic 1</p> <p>Light colour White</p> <p>Required components:</p>	
<p>LUMILEDS</p> <p>LED LUXEON Rubix</p> <p>FWHM / FWTM 25.0° / 43.0°</p> <p>Efficiency 94 %</p> <p>Peak intensity 4.4 cd/lm</p> <p>LEDs/each optic 4</p> <p>Light colour RGBW</p> <p>Required components:</p>	
<p>NICHIA</p> <p>LED COB S-Type (LES 6)</p> <p>FWHM / FWTM 26.0° / 46.0°</p> <p>Efficiency 92 %</p> <p>Peak intensity 4.1 cd/lm</p> <p>LEDs/each optic 1</p> <p>Light colour White</p> <p>Required components: F15848_HEKLA-SOCKET-G</p>	

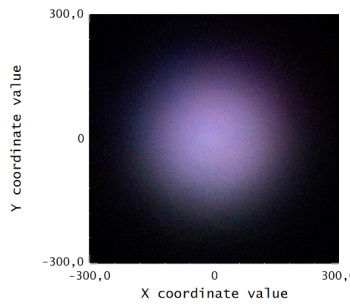

OPTICAL RESULTS (SIMULATED):

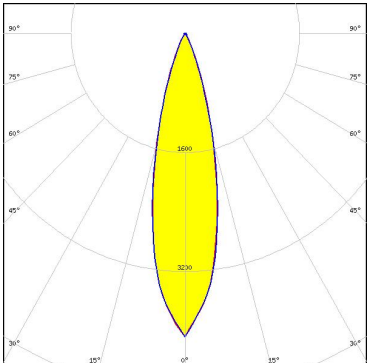
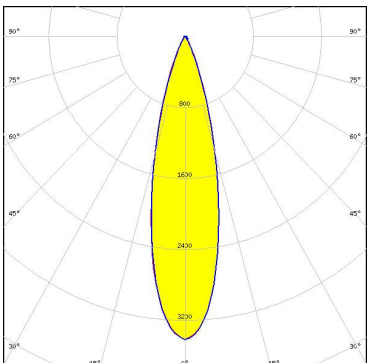
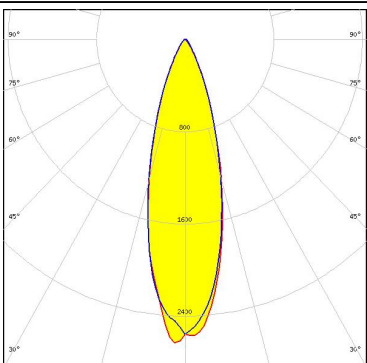
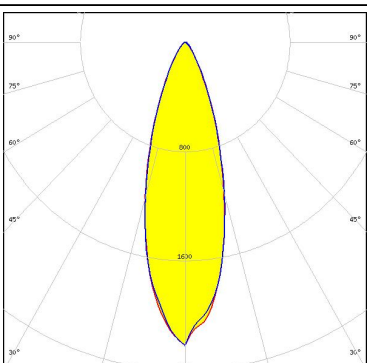
<p>NICHIA</p> <p>LED COB S-Type (LES 7)</p> <p>FWHM / FWTM 26.0° / 46.0°</p> <p>Efficiency 94 %</p> <p>Peak intensity 4.1 cd/lm</p> <p>LEDs/each optic 1</p> <p>Light colour White</p> <p>Required components: F15848_HEKLA-SOCKET-G</p>	
<p>NICHIA</p> <p>LED NFSWE11A</p> <p>FWHM / FWTM 26.0° / 48.0°</p> <p>Efficiency 87 %</p> <p>Peak intensity 3.4 cd/lm</p> <p>LEDs/each optic 30</p> <p>Light colour White</p> <p>Required components: C16142_HEKLA-SOCKET-K</p>	
<p>PHILIPS</p> <p>LED Fortimo SLM L13 CoB</p> <p>FWHM / FWTM 29.0° / 56.0°</p> <p>Efficiency 91 %</p> <p>Peak intensity 2.6 cd/lm</p> <p>LEDs/each optic 1</p> <p>Light colour White</p> <p>Required components: Bender Wirth: 632a Hekla XL</p>	
<p>PHILIPS</p> <p>LED Fortimo SLM L15 CoB</p> <p>FWHM / FWTM 32.0° / 62.0°</p> <p>Efficiency 89 %</p> <p>Peak intensity 2.2 cd/lm</p> <p>LEDs/each optic 1</p> <p>Light colour White</p> <p>Required components: Bender Wirth: 632a Hekla XL</p>	

OPTICAL RESULTS (SIMULATED):

SAMSUNG

LED LC010C
FWHM / FWTM 26.0° / 46.0°
Efficiency 92 %
Peak intensity 4.1 cd/lm
LEDs/each optic 1
Light colour White
Required components:
F15848_HEKLA-SOCKET-G

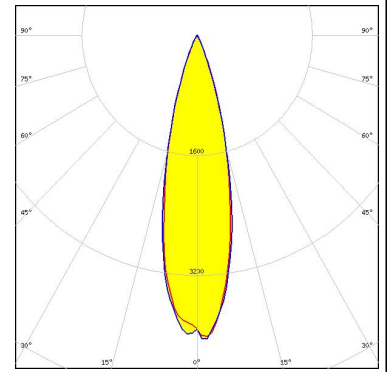

SAMSUNG

LED LC020C
FWHM / FWTM 26.0° / 46.0°
Efficiency 93 %
Peak intensity 4.1 cd/lm
LEDs/each optic 1
Light colour White
Required components:
F17438_HEKLA-G2-I

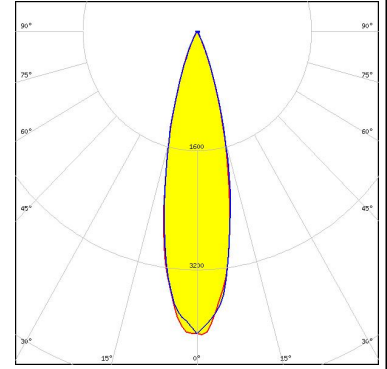

XICATO

LED XTM - 9mm LES
FWHM / FWTM 26.0° / 49.0°
Efficiency 93 %
Peak intensity 3.6 cd/lm
LEDs/each optic 1
Light colour White
Required components:
C15743_XTM-ADAPTER-50-B

