

## AMY-45-M

~24° medium beam

### SPECIFICATION:

|                |           |
|----------------|-----------|
| Dimensions     | Ø 45.0 mm |
| Height         | 10 mm     |
| ROHS compliant | yes ⓘ     |

### MATERIALS:

| Component | Type        | Material | Colour | Finish |
|-----------|-------------|----------|--------|--------|
| AMY-45-M  | Single lens | PMMA     |        |        |







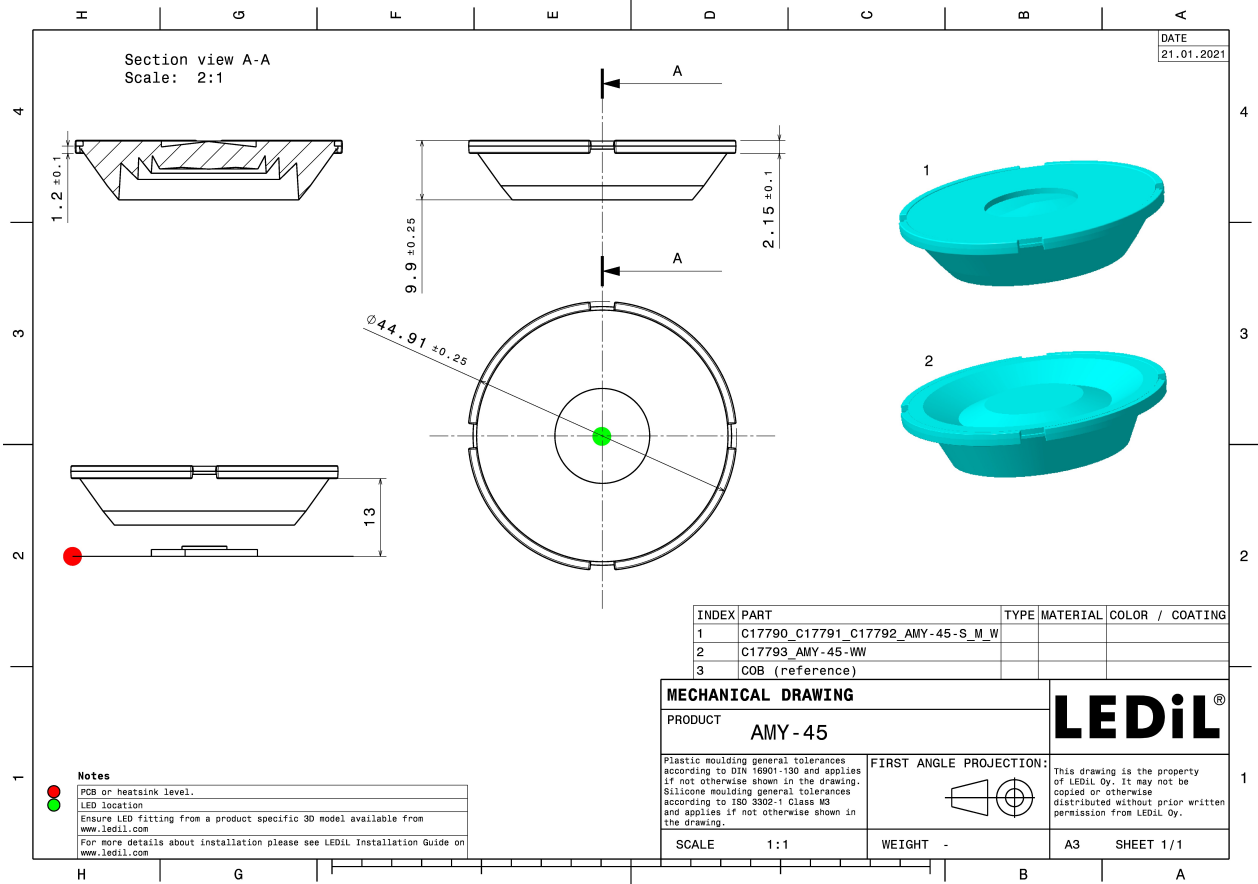



### ORDERING INFORMATION:

| Component   | Qty in box | MOQ | MPQ | Box weight (kg) |
|---|------------|-----|-----|-----------------|
| C17791_AMY-45-M<br>» Box size: 480 x 280 x 300 mm | 1035       | 180 | 45  | 10.1            |

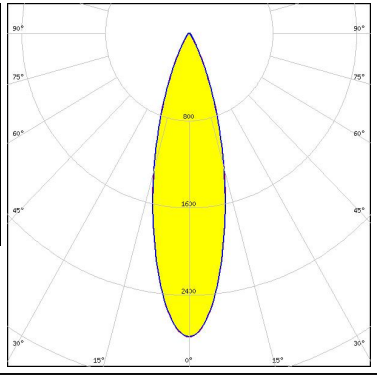

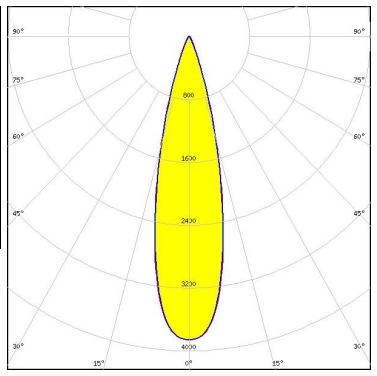
See also our general installation guide: [www.ledil.com/installation\\_guide](http://www.ledil.com/installation_guide)

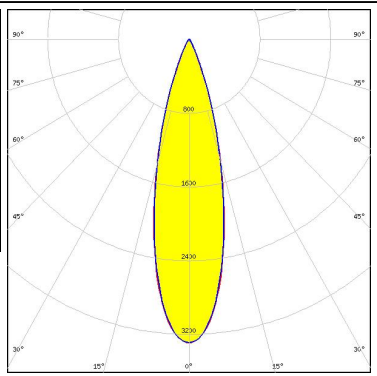
#### OPTICAL RESULTS (MEASURED):

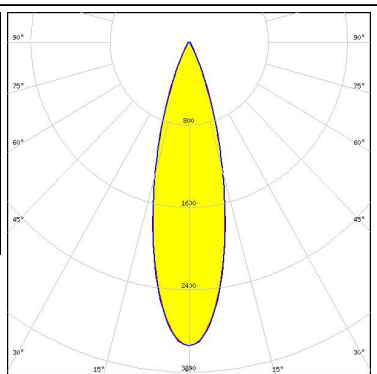
|  |  |   |
|--|--|---|
| <p></p> <p>LED V11 HD Gen 8</p> <p>FWHM / FWTM 29.0° / 54.0°</p> <p>Efficiency 89 %</p> <p>Peak intensity 2.8 cd/m</p> <p>LEDs/each optic 1</p> <p>Light colour White</p> <p>Required components:<br/>Bender Wirth: 633d Hekla</p> |    |    |
| <p></p> <p>LED V6 HD Gen 7</p> <p>FWHM / FWTM 26.0° / 44.0°</p> <p>Efficiency 89 %</p> <p>Peak intensity 3.9 cd/m</p> <p>LEDs/each optic 1</p> <p>Light colour White</p> <p>Required components:<br/>F15255_HEKLA-SOCKET-C</p>     |   |   |
| <p></p> <p>LED V9 HD Gen7</p> <p>FWHM / FWTM 27.0° / 48.0°</p> <p>Efficiency 86 %</p> <p>Peak intensity 3.3 cd/m</p> <p>LEDs/each optic 1</p> <p>Light colour White</p> <p>Required components:<br/>F15859_HEKLA-SOCKET-I</p>    |  |  |
| <p><b>CITIZEN</b></p> <p>LED CLL02x/CLU02x (LES10)</p> <p>FWHM / FWTM 28.0° / 51.0°</p> <p>Efficiency 86 %</p> <p>Peak intensity 2.9 cd/m</p> <p>LEDs/each optic 1</p> <p>Light colour White</p> <p>Required components:<br/>F17435_HEKLA-G2-C</p>   |  |  |

#### OPTICAL RESULTS (MEASURED):

### CITIZEN

LED CLU700/701/702/703  
 FWHM / FWTM 25.0° / 43.0°  
 Efficiency 88 %  
 Peak intensity 3.9 cd/m  
 LEDs/each optic 1  
 Light colour White  
 Required components:  
 F17435\_HEKLA-G2-C

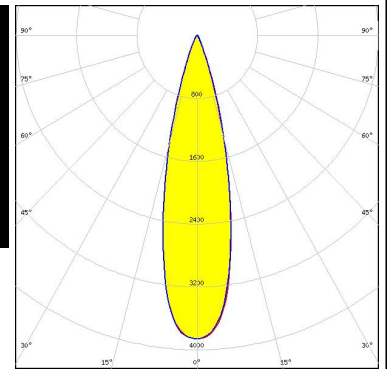
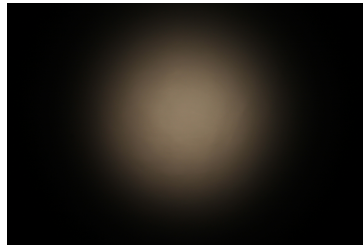

LED CMA1516  
 FWHM / FWTM 28.0° / 50.0°  
 Efficiency 86 %  
 Peak intensity 3.1 cd/m  
 LEDs/each optic 1  
 Light colour White  
 Required components:  
 F17436\_HEKLA-G2-D

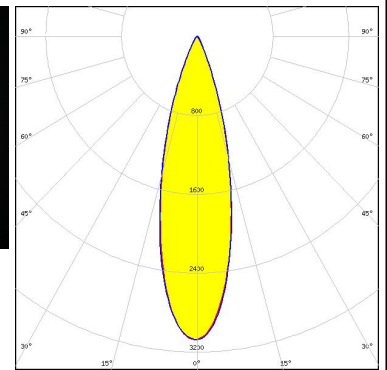
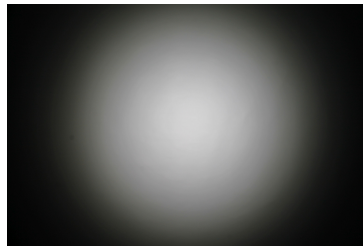



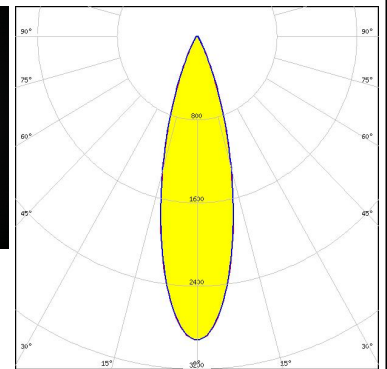
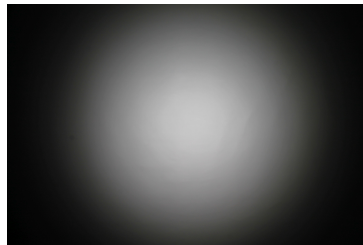

LED CMT14xx  
 FWHM / FWTM 28.0° / 51.0°  
 Efficiency 86 %  
 Peak intensity 2.9 cd/m  
 LEDs/each optic 1  
 Light colour White  
 Required components:  
 F17435\_HEKLA-G2-C

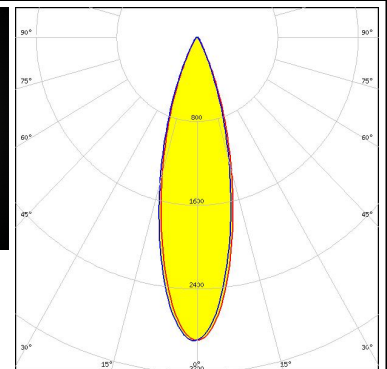
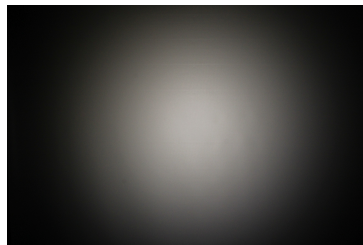



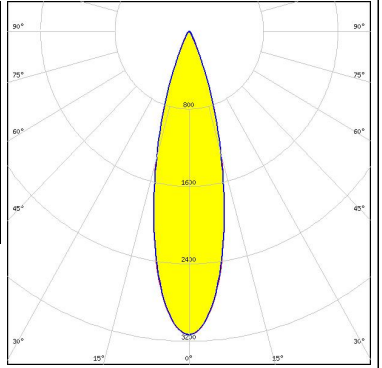

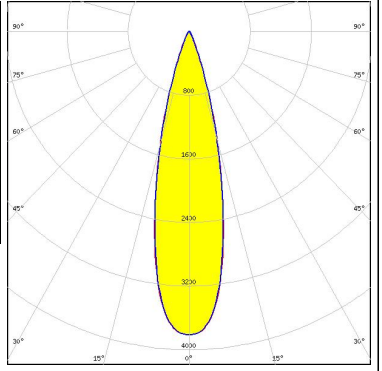
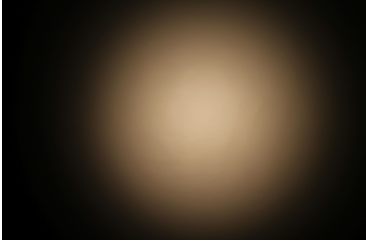
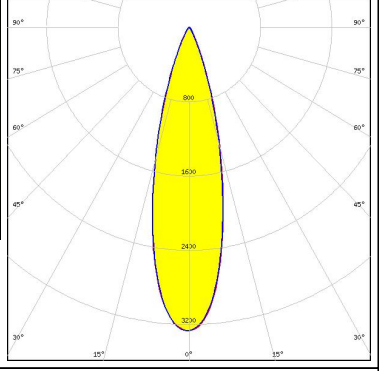

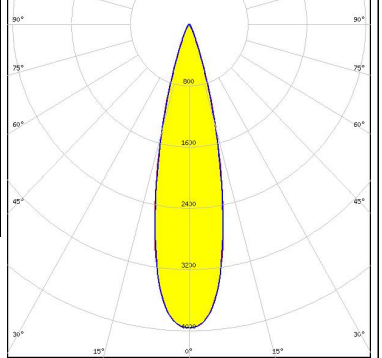
LED CMU10xx  
 FWHM / FWTM 28.0° / 53.0°  
 Efficiency 90 %  
 Peak intensity 2.9 cd/m  
 LEDs/each optic 1  
 Light colour White  
 Required components:  
 BJB: 47.360.1020

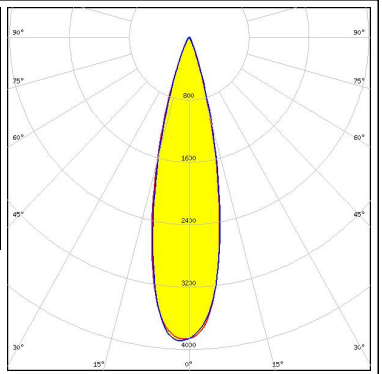

#### OPTICAL RESULTS (MEASURED):

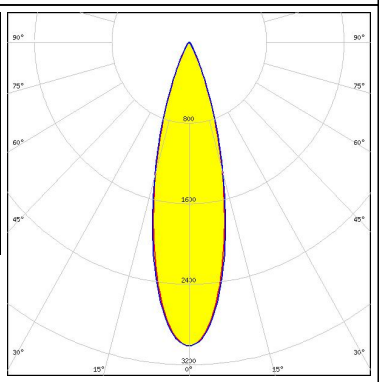
|  |  |   |
|--|--|---|
| <p><b>LUMILEDS</b></p> <p>LED LUXEON CoB 1202/1203</p> <p>FWHM / FWTM 27.0° / 49.0°</p> <p>Efficiency 85 %</p> <p>Peak intensity 3.1 cd/lm</p> <p>LEDs/each optic 1</p> <p>Light colour White</p> <p>Required components:<br/>F17437_HEKLA-G2-H</p>                    |    |    |
| <p><b>LUMILEDS</b></p> <p>LED LUXEON CoB 1202s</p> <p>FWHM / FWTM 26.0° / 44.0°</p> <p>Efficiency 89 %</p> <p>Peak intensity 3.8 cd/lm</p> <p>LEDs/each optic 1</p> <p>Light colour White</p> <p>Required components:<br/>F15848_HEKLA-SOCKET-G</p>                    |   |   |
| <p><b>LUMILEDS</b></p> <p>LED LUXEON CX Plus CoB M02 / M03 (Gen2)</p> <p>FWHM / FWTM 27.0° / 49.0°</p> <p>Efficiency 89 %</p> <p>Peak intensity 3.3 cd/lm</p> <p>LEDs/each optic 1</p> <p>Light colour White</p> <p>Required components:<br/>F15256_HEKLA-SOCKET-D</p> |  |  |
| <p><b>LUMILEDS</b></p> <p>LED LUXEON CX Plus CoB S01 (Gen2)</p> <p>FWHM / FWTM 26.0° / 44.0°</p> <p>Efficiency 90 %</p> <p>Peak intensity 4 cd/lm</p> <p>LEDs/each optic 1</p> <p>Light colour White</p> <p>Required components:<br/>F15956_HEKLA-SOCKET-J</p>         |  |  |

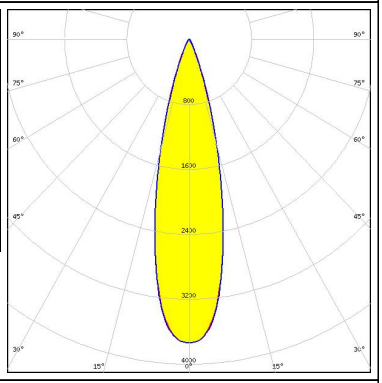
#### OPTICAL RESULTS (MEASURED):

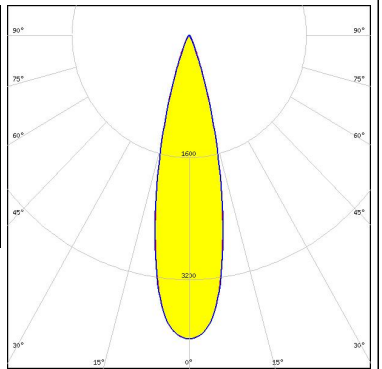
|   |  |   |
|---|--|---|
| <p><b>LUMINUS</b></p> <p>LED CxM-6 (13.5x13.5)</p> <p>FWHM / FWTM 25.0° / 44.0°</p> <p>Efficiency 88 %</p> <p>Peak intensity 3.9 cd/lm</p> <p>LEDs/each optic 1</p> <p>Light colour White</p> <p>Required components:<br/>F17435_HEKLA-G2-C</p>     |    |    |
| <p><b>LUMINUS</b></p> <p>LED CxM-9 (13.5x13.5)</p> <p>FWHM / FWTM 28.0° / 50.0°</p> <p>Efficiency 86 %</p> <p>Peak intensity 3 cd/lm</p> <p>LEDs/each optic 1</p> <p>Light colour White</p> <p>Required components:<br/>F17435_HEKLA-G2-C</p>       |   |   |
| <p><b>NICHIA</b></p> <p>LED COB S-Type (LES 7)</p> <p>FWHM / FWTM 26.0° / 45.0°</p> <p>Efficiency 89 %</p> <p>Peak intensity 3.7 cd/lm</p> <p>LEDs/each optic 1</p> <p>Light colour White</p> <p>Required components:<br/>F15848_HEKLA-SOCKET-G</p> |  |  |
| <p><b>NICHIA</b></p> <p>LED COB T-Type</p> <p>FWHM / FWTM 25.0° / 43.0°</p> <p>Efficiency 90 %</p> <p>Peak intensity 4 cd/lm</p> <p>LEDs/each optic 1</p> <p>Light colour White</p> <p>Required components:<br/>F15848_HEKLA-SOCKET-G</p>           |  |  |

#### OPTICAL RESULTS (MEASURED):

### SAMSUNG

LED LC003D / LC006D / LC009D / LC013D  
 FWHM / FWTM 28.0° / 52.0°  
 Efficiency 95 %  
 Peak intensity 3.1 cd/m  
 LEDs/each optic 1  
 Light colour White  
 Required components:

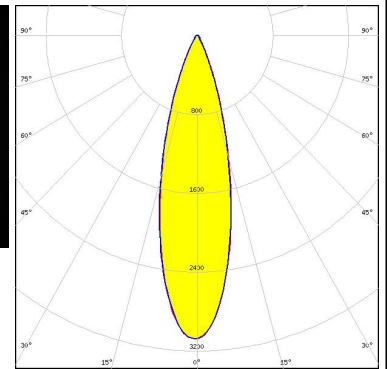
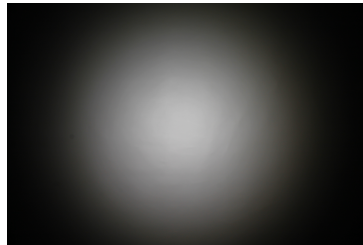

SEOUL SEMICONDUCTOR

LED MJT COB LES 6  
 FWHM / FWTM 25.0° / 43.0°  
 Efficiency 88 %  
 Peak intensity 3.9 cd/m  
 LEDs/each optic 1  
 Light colour White  
 Required components:  
 F17435\_HEKLA-G2-C

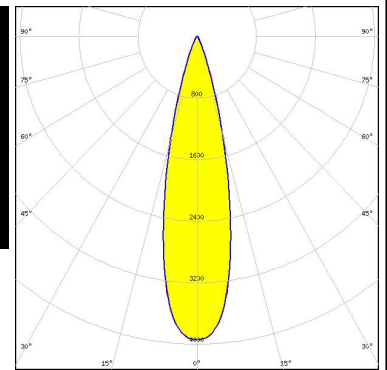
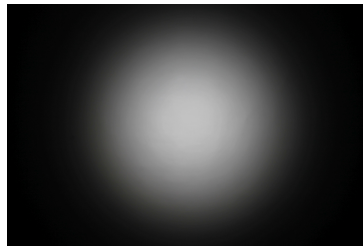

SEOUL SEMICONDUCTOR

LED MJT COB LES 9.8  
 FWHM / FWTM 28.0° / 51.0°  
 Efficiency 86 %  
 Peak intensity 3 cd/m  
 LEDs/each optic 1  
 Light colour White  
 Required components:  
 F17435\_HEKLA-G2-C

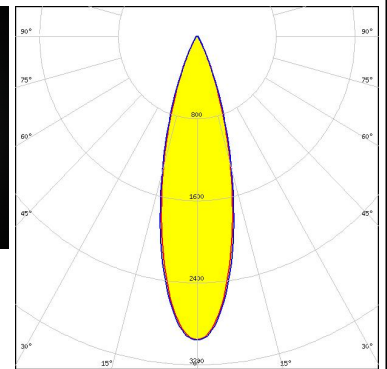
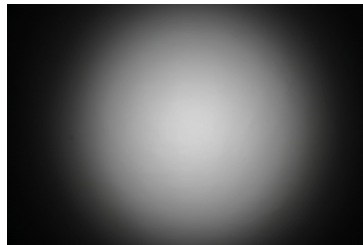

#### OPTICAL RESULTS (SIMULATED):

### CITIZEN

LED CLU712/713  
FWHM / FWTM 26.0° / 48.0°  
Efficiency 93 %  
Peak intensity 3.6 cd/lm  
LEDs/each optic 1  
Light colour White  
Required components:  
F17438\_HEKLA-G2-I

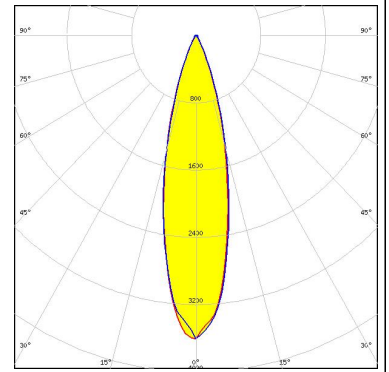

LED CMA1825  
FWHM / FWTM 29.0° / 59.0°  
Efficiency 90 %  
Peak intensity 2.5 cd/lm  
LEDs/each optic 1  
Light colour White  
Required components:  
F15254\_HEKLA-SOCKET-B

