

OLGA-WW

~60° wide beam with flange.

SPECIFICATION:

Dimensions	Ø 30.0 mm
Height	18.5 mm
Fastening	glue
ROHS compliant	yes ⓘ

MATERIALS:

Component	Type	Material	Colour	Finish
OLGA-WW	Single lens	PMMA		



ORDERING INFORMATION:

Component	Qty in box	MOQ	MPQ	Box weight (kg)
C18062_OLGA-WW » Box size: 476 x 273 x 292 mm	792	132	66	7.7

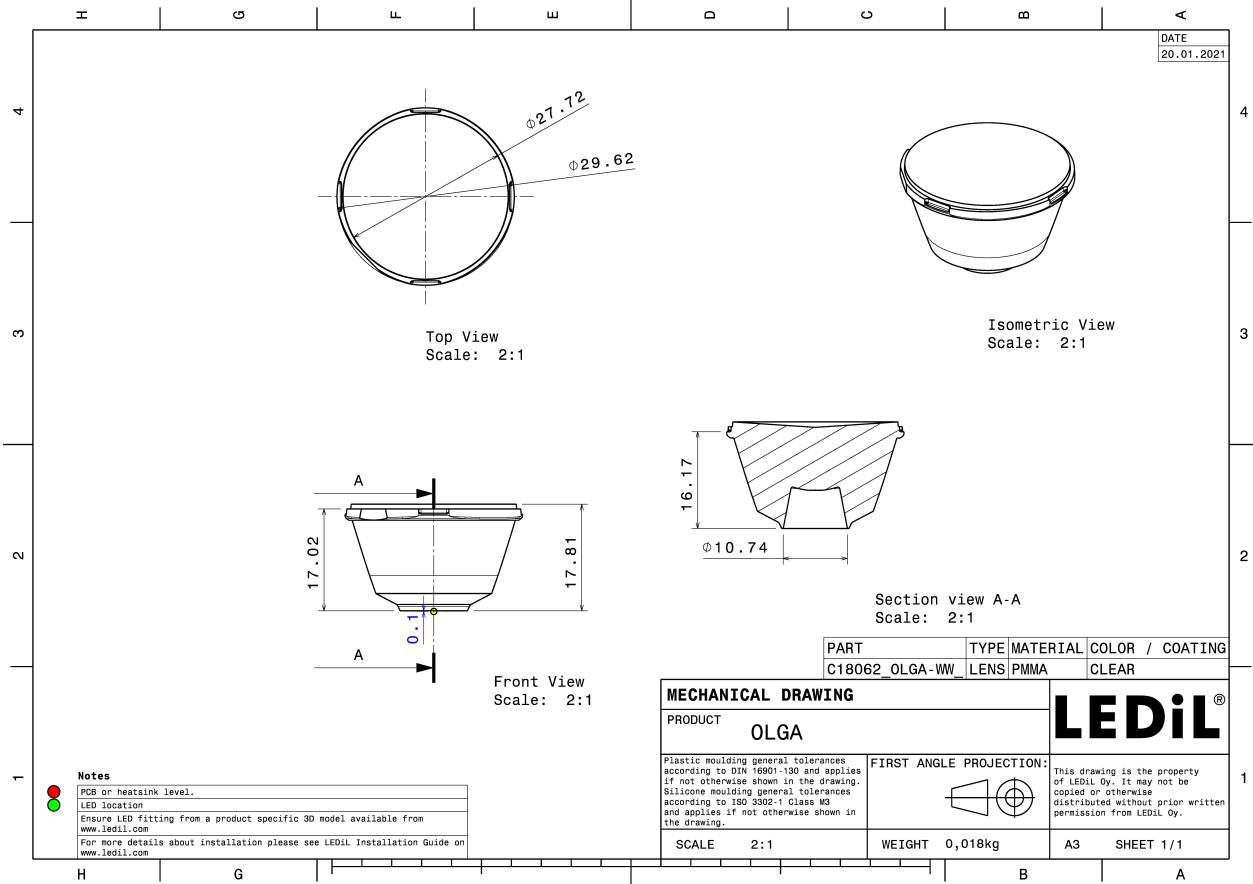

See also our general installation guide: www.ledil.com/installation_guide

OPTICAL RESULTS (MEASURED):

CITIZEN

LED CLU7L3
 FWHM / FWTM 52.0° / 78.0°
 Efficiency 82 %
 Peak intensity 1.1 cd/lm
 LEDs/each optic 1
 Light colour White
 Required components:

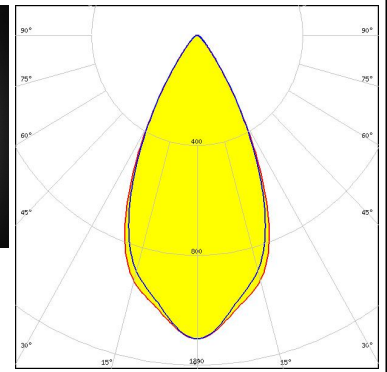

CITIZEN

LED CLU7R3
 FWHM / FWTM 52.0° / 79.0°
 Efficiency 81 %
 Peak intensity 1 cd/lm
 LEDs/each optic 1
 Light colour White
 Required components:

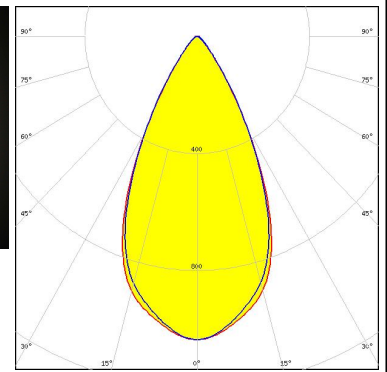
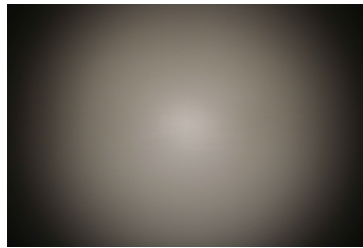

CITIZEN

LED CLU7S3
 FWHM / FWTM 53.0° / 78.0°
 Efficiency 88 %
 Peak intensity 1.1 cd/lm
 LEDs/each optic 1
 Light colour White
 Required components:

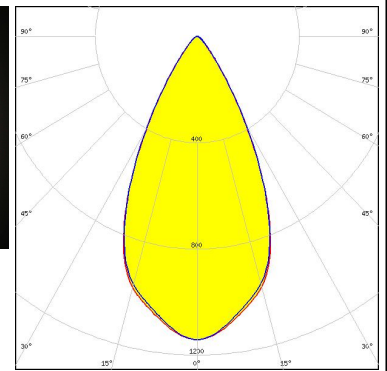
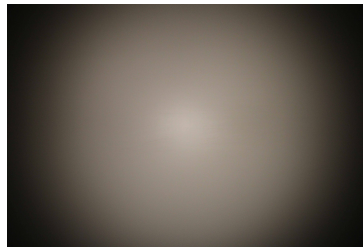

OPTICAL RESULTS (SIMULATED):

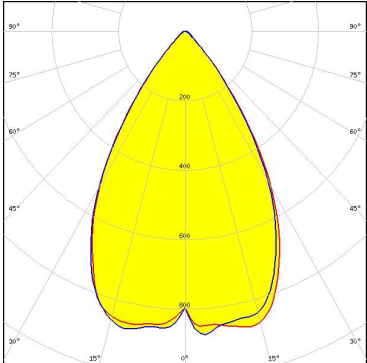
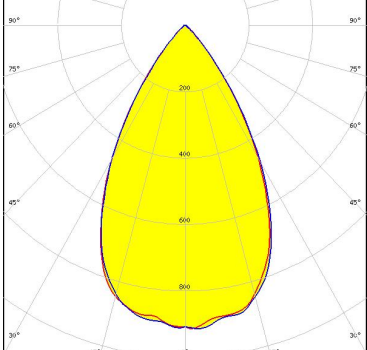
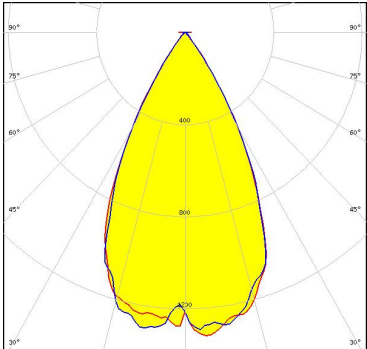
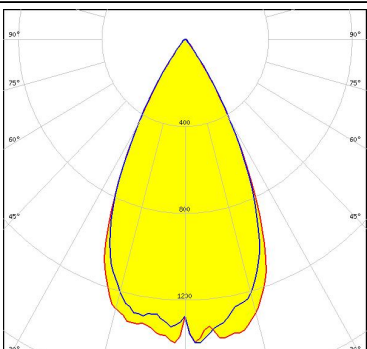
<p>bridgelux.</p> <p>LED V4 HD Gen 7</p> <p>FWHM / FWTM 64.0° / 89.0°</p> <p>Efficiency 95 %</p> <p>Peak intensity 0.9 cd/lm</p> <p>LEDs/each optic 1</p> <p>Light colour White</p> <p>Required components:</p>	
<p>CREE LEDs</p> <p>LED XP-G3</p> <p>FWHM / FWTM 60.0° / 86.0°</p> <p>Efficiency 87 %</p> <p>Peak intensity 0.9 cd/lm</p> <p>LEDs/each optic 1</p> <p>Light colour White</p> <p>Required components:</p>	
<p>CREE LEDs</p> <p>LED XP-G3</p> <p>FWHM / FWTM 54.0° / 74.0°</p> <p>Efficiency 90 %</p> <p>LEDs/each optic 1</p> <p>Light colour White</p> <p>Required components:</p>	
<p>LUMILEDS</p> <p>LED LUXEON 5050 Round LES</p> <p>FWHM / FWTM 52.0° / 72.0°</p> <p>Efficiency 90 %</p> <p>LEDs/each optic 1</p> <p>Light colour White</p> <p>Required components:</p>	

OPTICAL RESULTS (SIMULATED):



LED CXM-3
FWHM / FWTM 60.0° / 82.0°
Efficiency 90 %
LEDs/each optic 1
Light colour White
Required components:

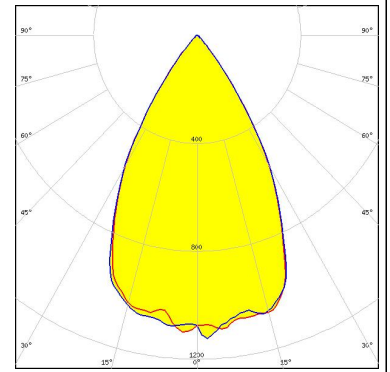

LED NVCWJ024Z-V1MT: COB J-Type Tunable White
FWHM / FWTM 72.0° / 101.0°
Efficiency 86 %
LEDs/each optic 1
Light colour White
Required components:

