

C3M0032120J1

Silicon Carbide Power MOSFET

C3M™ MOSFET Technology

N-Channel Enhancement Mode

Features

- 3rd generation SiC MOSFET technology
- Optimized package with separate driver source pin
- 8mm of creepage distance between drain and source
- High blocking voltage with low on-resistance
- High-speed switching with low capacitances
- Fast intrinsic diode with low reverse recovery (Q_{rr})
- Halogen free, RoHS compliant

Benefits

- Reduce switching losses and minimize gate ringing
- Higher system efficiency
- Reduce cooling requirements
- Increase power density
- Increase system switching frequency

Applications

- Solar inverters
- EV motor drive
- High voltage DC/DC converters
- Switched mode power supplies
- Load switch

V_{DS}	1200 V
$I_D @ 25^\circ\text{C}$	68 A
$R_{DS(on)}$	32 mΩ

Package

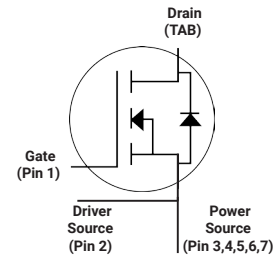

Part Number	Package	Marking
C3M0032120J1	TO-263-7L XL	C3M0032120J1

Maximum Ratings ($T_c = 25^\circ\text{C}$ unless otherwise specified)

Symbol	Parameter	Value	Unit	Test Conditions	Note
V_{DSmax}	Drain - Source Voltage	1200	V	$V_{GS} = 0\text{ V}, I_D = 100\ \mu\text{A}$	
V_{GSmax}	Gate - Source Voltage (dynamic)	-8/+19	V	AC ($f > 1\text{ Hz}$)	Note 1
V_{GSop}	Gate - Source Voltage (static)	-4/+15	V	Static	Note 2
I_D	Continuous Drain Current	68	A	$V_{GS} = 15\text{ V}, T_c = 25^\circ\text{C}$	Fig. 19
		44		$V_{GS} = 15\text{ V}, T_c = 100^\circ\text{C}$	
$I_{D(pulse)}$	Pulsed Drain Current	120	A	Pulse width t_p limited by T_{jmax}	
P_D	Power Dissipation	277	W	$T_c = 25^\circ\text{C}, T_j = 150^\circ\text{C}$	Fig. 20
T_J, T_{stg}	Operating Junction and Storage Temperature	-40 to +150	$^\circ\text{C}$		
T_L	Solder Temperature	260	$^\circ\text{C}$	1.6mm (0.063") from case for 10s	

Note (1): When using MOSFET Body Diode $V_{GSmax} = -4\text{V}/+19\text{V}$

Note (2): MOSFET can also safely operate at 0/+15 V

Electrical Characteristics ($T_c = 25^\circ\text{C}$ unless otherwise specified)

Symbol	Parameter	Min.	Typ.	Max.	Unit	Test Conditions	Note
$V_{(BR)DSS}$	Drain-Source Breakdown Voltage	1200			V	$V_{GS} = 0\text{ V}, I_D = 100\ \mu\text{A}$	
$V_{GS(th)}$	Gate Threshold Voltage	1.8	2.7	3.6	V	$V_{DS} = V_{GS}, I_D = 11.5\ \text{mA}$	Fig. 11
			2.2		V	$V_{DS} = V_{GS}, I_D = 11.5\ \text{mA}, T_J = 150^\circ\text{C}$	
I_{DSS}	Zero Gate Voltage Drain Current		1	50	μA	$V_{DS} = 1200\ \text{V}, V_{GS} = 0\ \text{V}$	
I_{GSS}	Gate-Source Leakage Current		10	250	nA	$V_{GS} = 15\ \text{V}, V_{DS} = 0\ \text{V}$	
$R_{DS(on)}$	Drain-Source On-State Resistance	23	32	43	m Ω	$V_{GS} = 15\ \text{V}, I_D = 41.4\ \text{A}$	Fig. 4, 5, 6
			55			$V_{GS} = 15\ \text{V}, I_D = 41.4\ \text{A}, T_J = 150^\circ\text{C}$	
g_{fs}	Transconductance		25		S	$V_{DS} = 20\ \text{V}, I_{DS} = 41.4\ \text{A}$	Fig. 7
			24			$V_{DS} = 20\ \text{V}, I_{DS} = 41.4\ \text{A}, T_J = 150^\circ\text{C}$	
C_{iss}	Input Capacitance		3424		pF	$V_{GS} = 0\ \text{V}, V_{DS} = 1000\ \text{V}$ $f = 100\ \text{kHz}$ $V_{AC} = 25\ \text{mV}$	Fig. 17, 18
C_{oss}	Output Capacitance		133				
C_{riss}	Reverse Transfer Capacitance		11				
E_{oss}	C_{oss} Stored Energy		72		μJ		Fig. 16
E_{ON}	Turn-On Switching Energy (Body Diode FWD)		360		μJ	$V_{DS} = 800\ \text{V}, V_{GS} = -4\ \text{V}/+15\ \text{V},$ $I_D = 41.4\ \text{A}, R_{G(ext)} = 2.5\ \Omega, L = 99\ \mu\text{H},$	Fig. 26
E_{OFF}	Turn Off Switching Energy (Body Diode FWD)		90				
$t_{d(on)}$	Turn-On Delay Time		15		ns	$V_{DD} = 800\ \text{V}, V_{GS} = -4\ \text{V}/15\ \text{V}$ $R_{G(ext)} = 2.5\ \Omega, I_D = 41.4\ \text{A}, L = 99\ \mu\text{H}$ Timing relative to V_{DS} , Inductive load	Fig. 27
t_r	Rise Time		16				
$t_{d(off)}$	Turn-Off Delay Time		25				
t_f	Fall Time		7				
$R_{G(int)}$	Internal Gate Resistance		1.6		Ω	$f = 1\ \text{MHz}, V_{AC} = 25\ \text{mV}$	
Q_{gs}	Gate to Source Charge		40		nC	$V_{DS} = 800\ \text{V}, V_{GS} = -4\ \text{V}/15\ \text{V}$ $I_D = 41.4\ \text{A}$ Per IEC60747-8-4 pg 21	Fig. 12
Q_{gd}	Gate to Drain Charge		28				
Q_g	Total Gate Charge		111				

Reverse Diode Characteristics ($T_c = 25^\circ\text{C}$ unless otherwise specified)

Symbol	Parameter	Typ.	Max.	Unit	Test Conditions	Note
V_{SD}	Diode Forward Voltage	5.0		V	$V_{GS} = -4\text{ V}, I_{SD} = 20\text{ A}, T_J = 25^\circ\text{C}$	Fig. 8, 9, 10
		4.5		V	$V_{GS} = -4\text{ V}, I_{SD} = 20\text{ A}, T_J = 150^\circ\text{C}$	
I_S	Continuous Diode Forward Current		49	A	$V_{GS} = -4\text{ V}, T_c = 25^\circ\text{C}$	Note 1
$I_{S, pulse}$	Diode pulse Current		120	A	$V_{GS} = -4\text{ V}$, pulse width t_p limited by T_{jmax}	Note 1
t_{rr}	Reverse Recover time	13		ns	$V_{GS} = -4\text{ V}, I_{SD} = 41.4\text{ A}, V_R = 800\text{ V}$ $dif/dt = 7450\text{ A}/\mu\text{s}, T_J = 150^\circ\text{C}$	Note 1
Q_{rr}	Reverse Recovery Charge	323		nC		
I_{rrm}	Peak Reverse Recovery Current	45		A		
t_{rr}	Reverse Recover time	18		ns	$V_{GS} = -4\text{ V}, I_{SD} = 41.4\text{ A}, V_R = 800\text{ V}$ $dif/dt = 2200\text{ A}/\mu\text{s}, T_J = 150^\circ\text{C}$	Note 1
Q_{rr}	Reverse Recovery Charge	164		nC		
I_{rrm}	Peak Reverse Recovery Current	16		A		

Thermal Characteristics

Symbol	Parameter	Typ.	Unit	Test Conditions	Note
$R_{\theta JC}$	Thermal Resistance from Junction to Case	0.45	$^\circ\text{C}/\text{W}$		Fig. 21
$R_{\theta JA}$	Thermal Resistance From Junction to Ambient	40			

Typical Performance

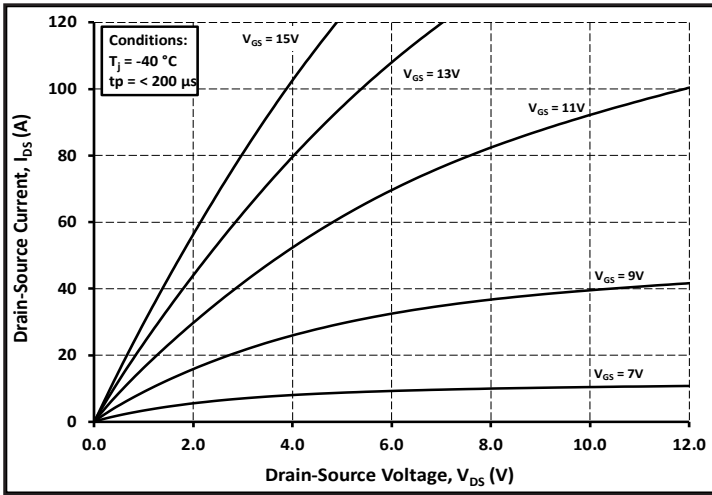

Figure 1. Output Characteristics $T_J = -40\text{ }^\circ\text{C}$

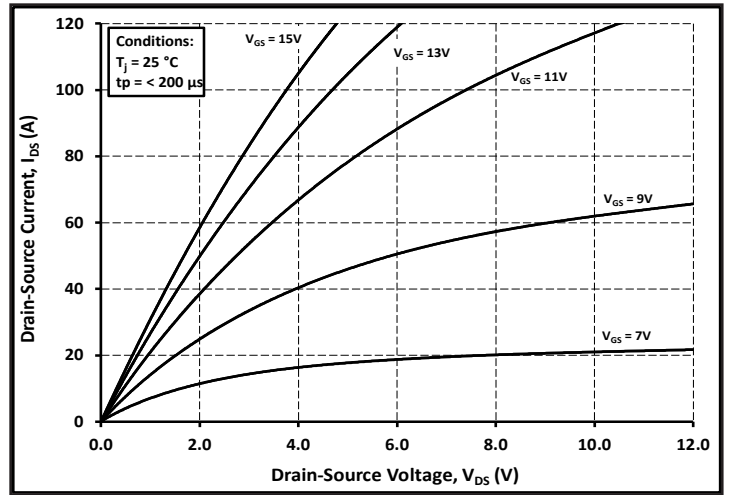

Figure 2. Output Characteristics $T_J = 25\text{ }^\circ\text{C}$

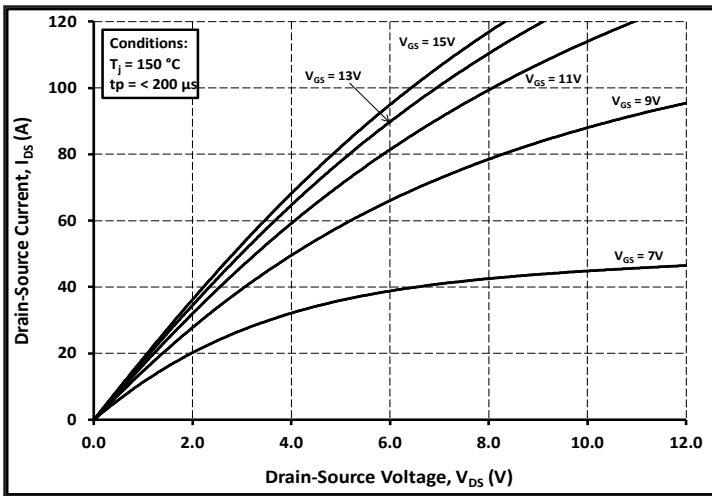

Figure 3. Output Characteristics $T_J = 150\text{ }^\circ\text{C}$

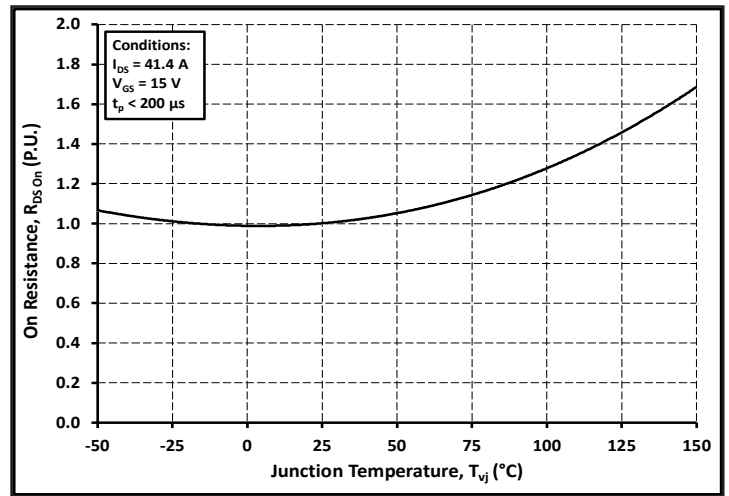

Figure 4. Normalized On-Resistance vs. Temperature

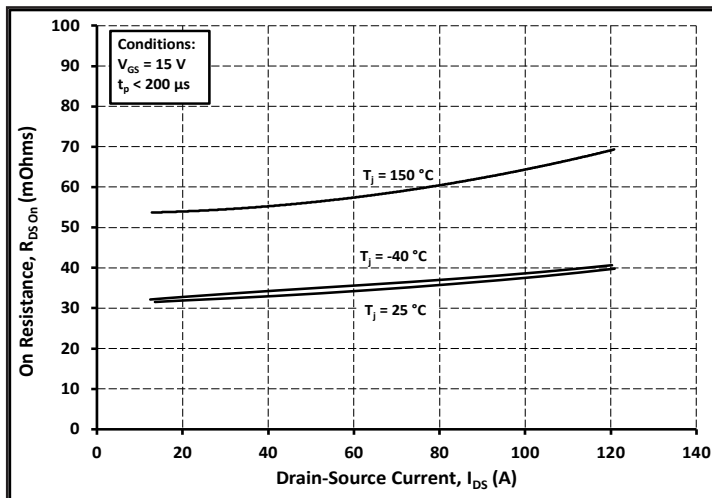

Figure 5. On-Resistance vs. Drain Current For Various Temperatures

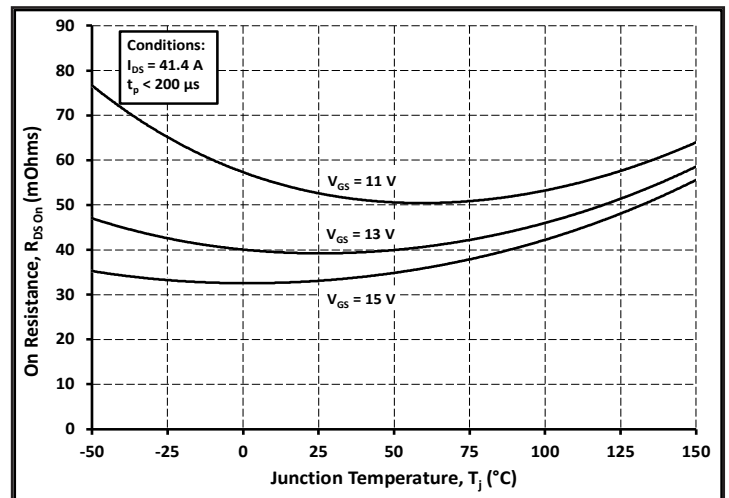

Figure 6. On-Resistance vs. Temperature For Various Gate Voltage

Typical Performance

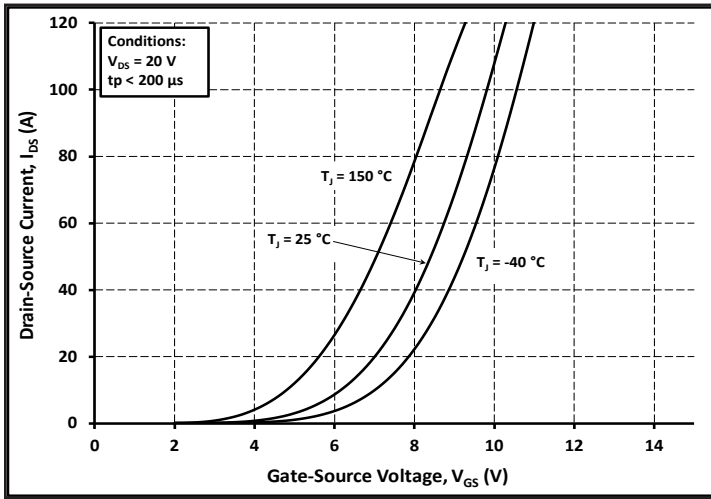

Figure 7. Transfer Characteristic for Various Junction Temperatures

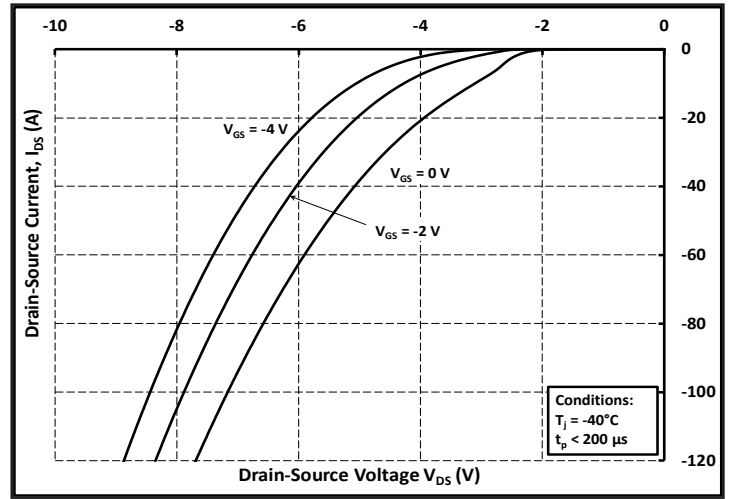

Figure 8. Body Diode Characteristic at -40 °C

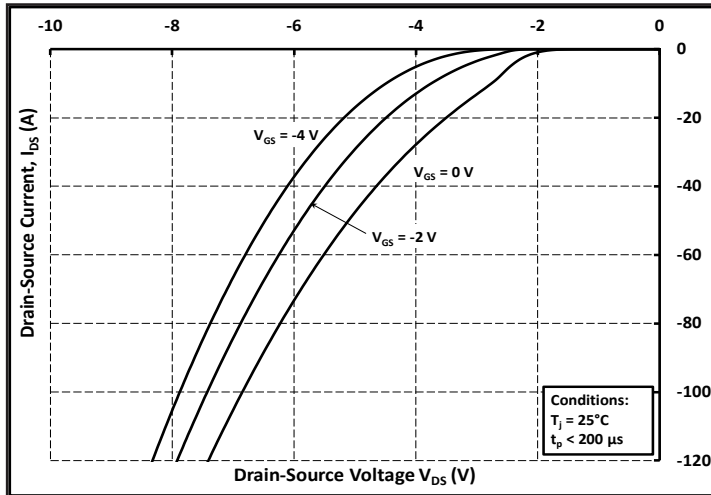

Figure 9. Body Diode Characteristic at 25 °C

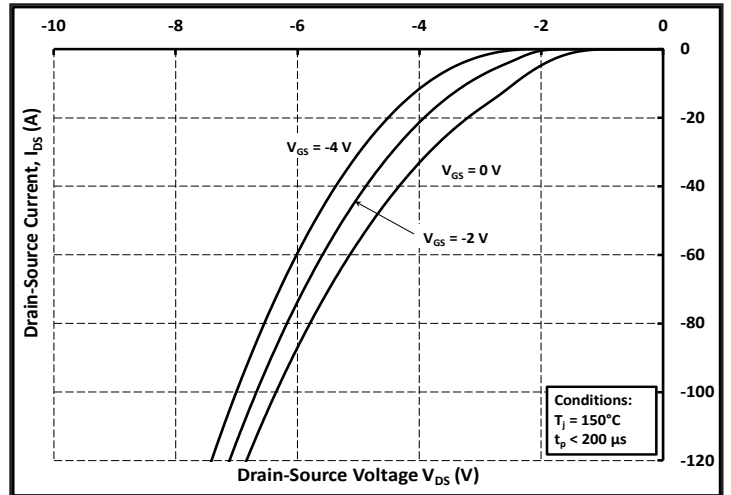

Figure 10. Body Diode Characteristic at 150 °C

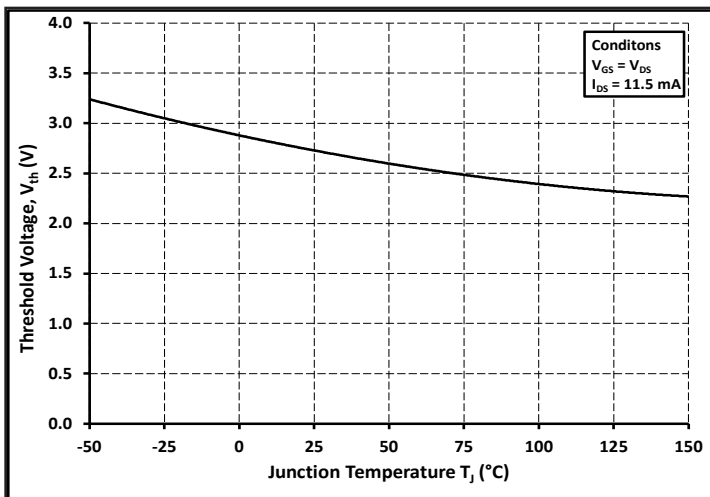

Figure 11. Threshold Voltage vs. Temperature

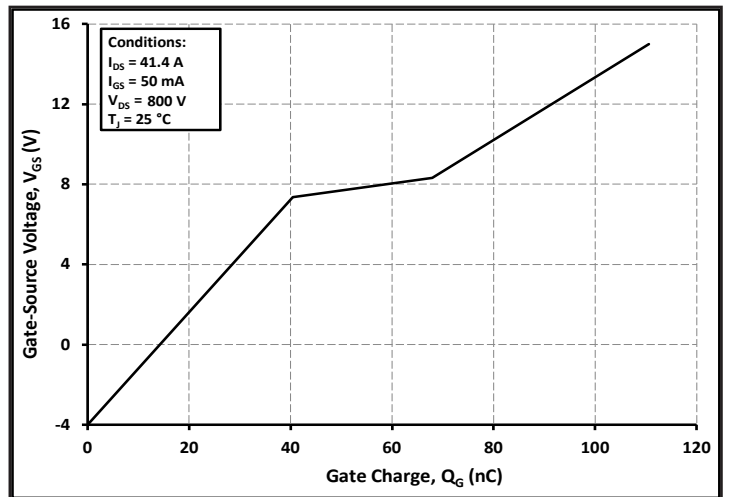

Figure 12. Gate Charge Characteristics

Typical Performance

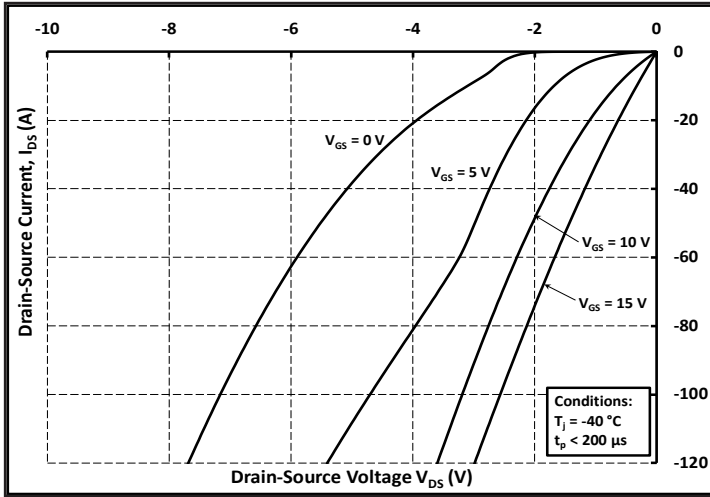

Figure 13. 3rd Quadrant Characteristic at -40 °C

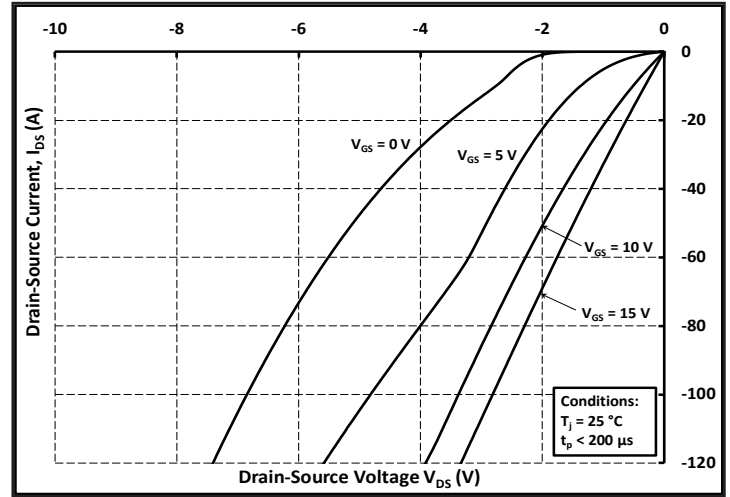

Figure 14. 3rd Quadrant Characteristic at 25 °C

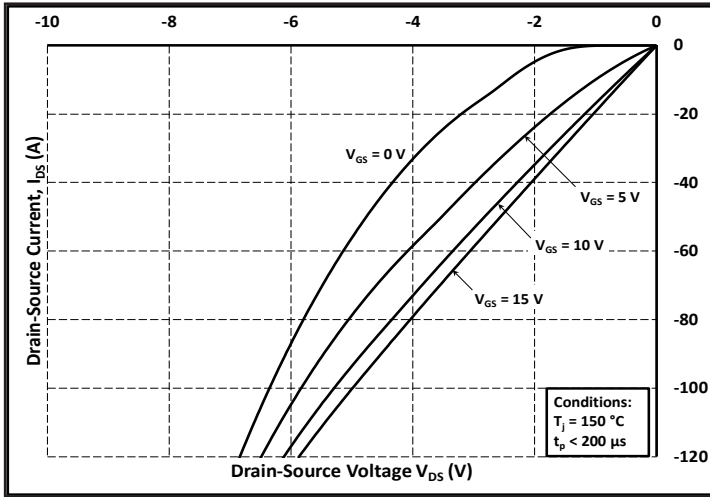

Figure 15. 3rd Quadrant Characteristic at 150 °C

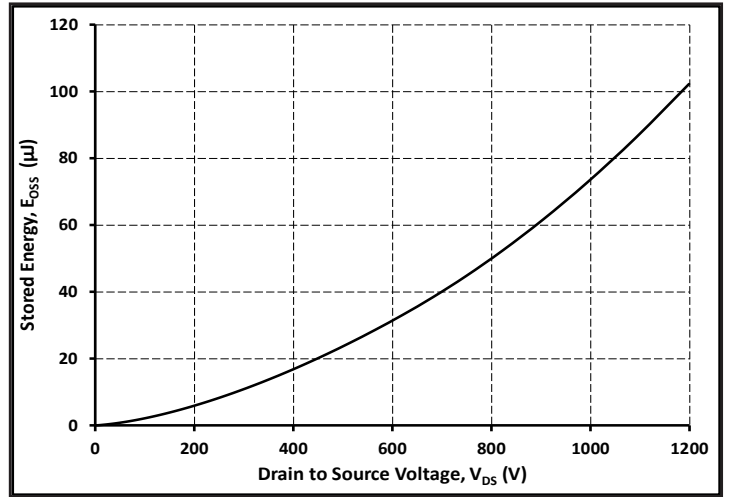

Figure 16. Output Capacitor Stored Energy

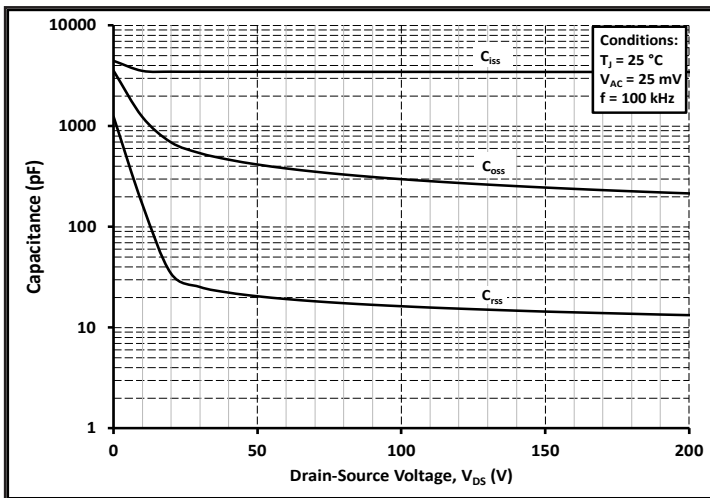

Figure 17. Capacitances vs. Drain-Source Voltage (0 - 200V)

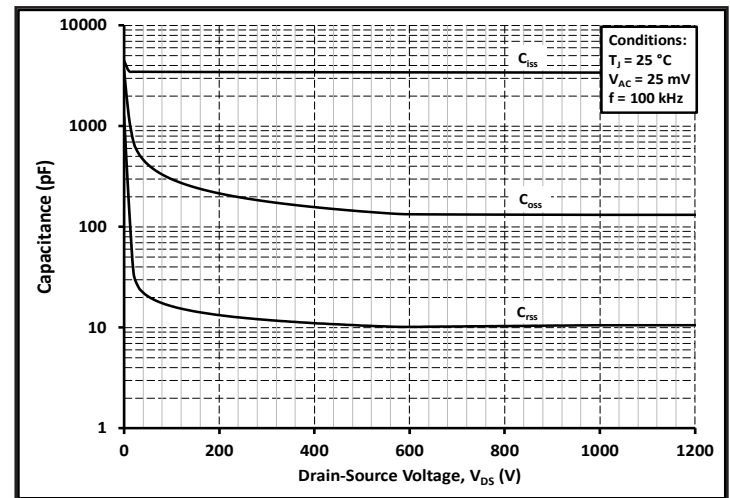

Figure 18. Capacitances vs. Drain-Source Voltage (0 - 1200V)

Typical Performance

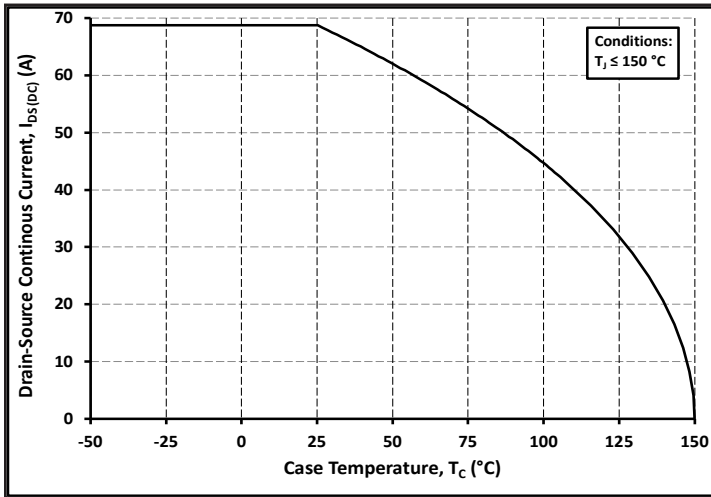

Figure 19. Continuous Drain Current Derating vs. Case Temperature

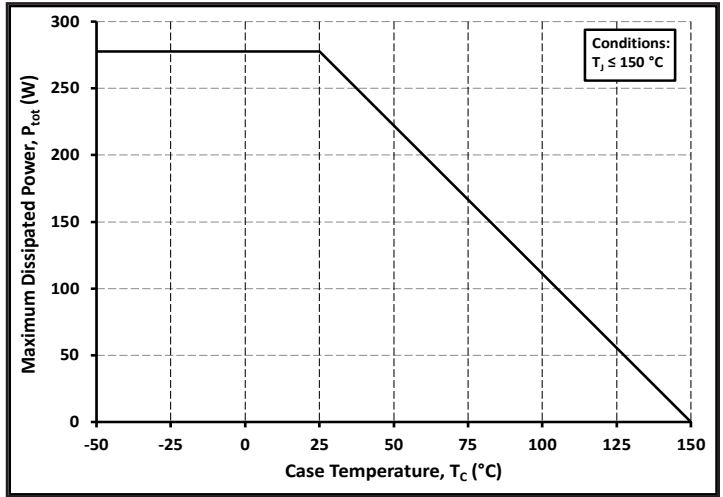

Figure 20. Maximum Power Dissipation Derating vs. Case Temperature

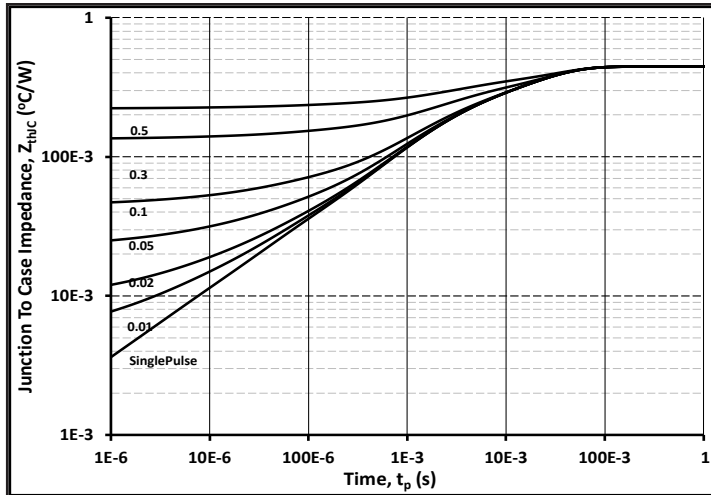

Figure 21. Transient Thermal Impedance (Junction - Case)

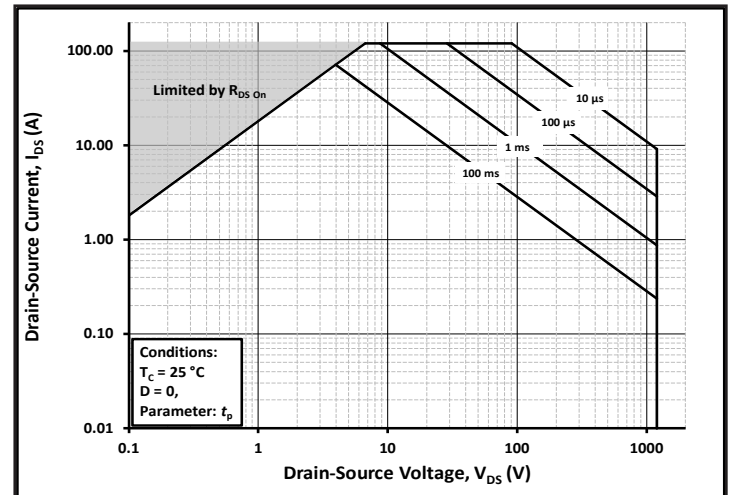

Figure 22. Safe Operating Area

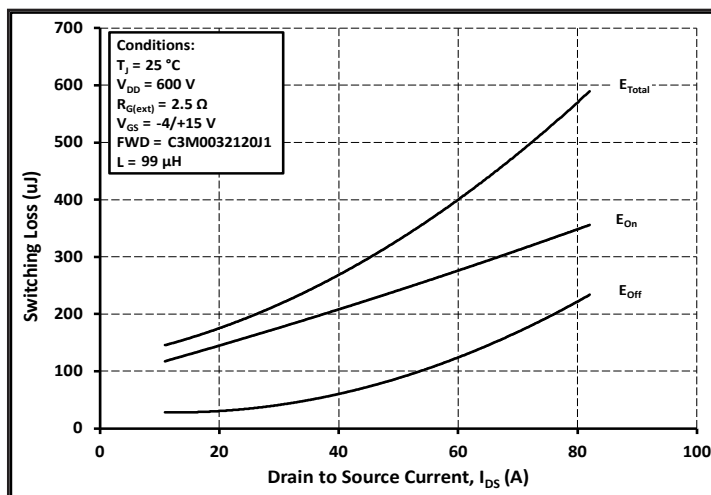

Figure 23. Clamped Inductive Switching Energy vs. Drain Current ($V_{DD} = 600V$)

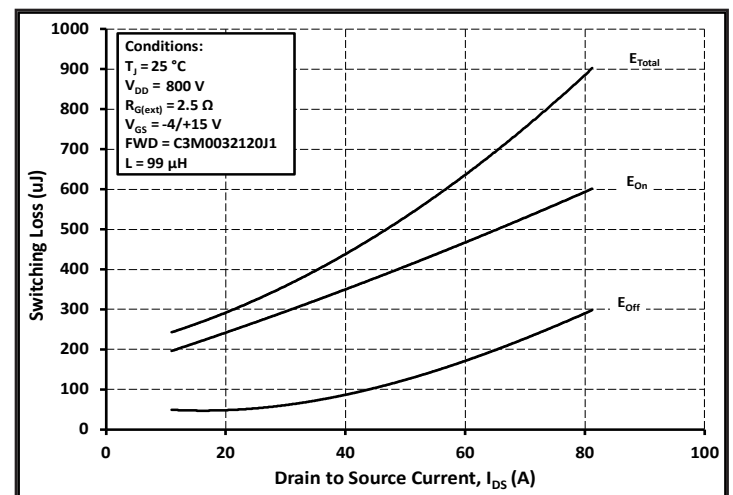

Figure 24. Clamped Inductive Switching Energy vs. Drain Current ($V_{DD} = 800V$)

Typical Performance

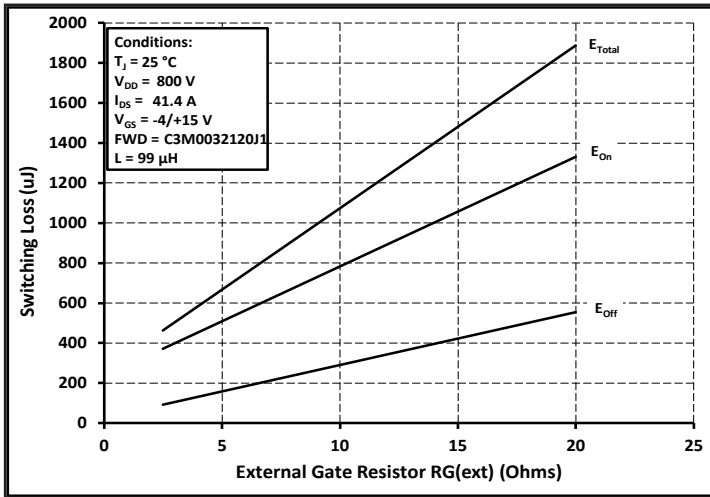

Figure 25. Clamped Inductive Switching Energy vs. $R_{G(ext)}$

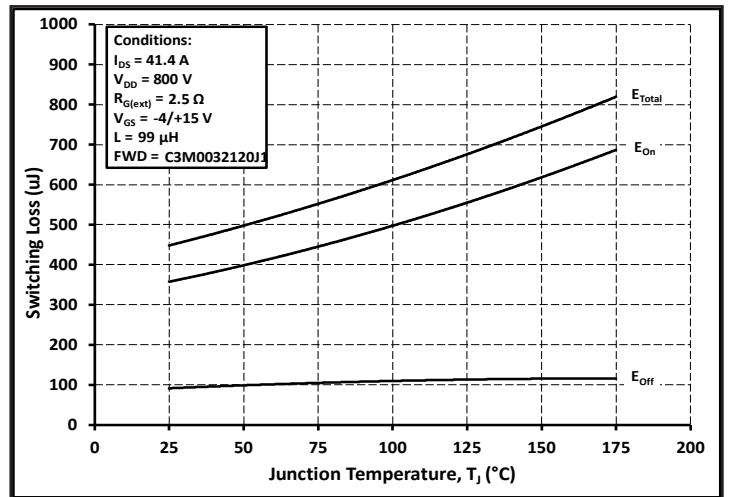

Figure 26. Clamped Inductive Switching Energy vs. Temperature

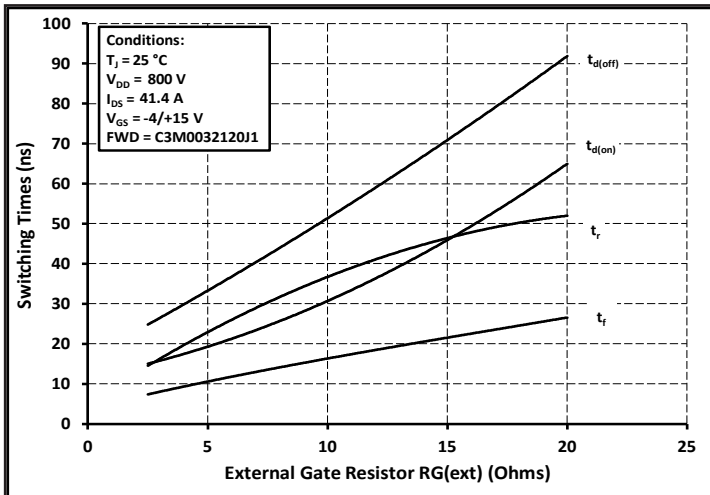

Figure 27. Switching Times vs. $R_{G(ext)}$

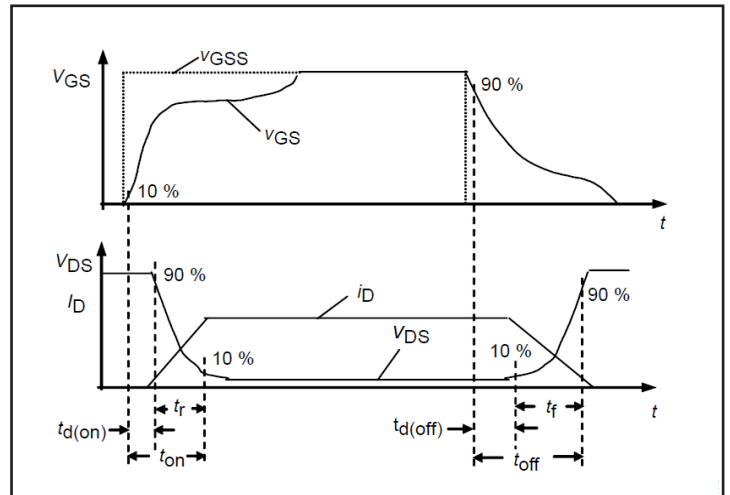

Figure 28. Switching Times Definition

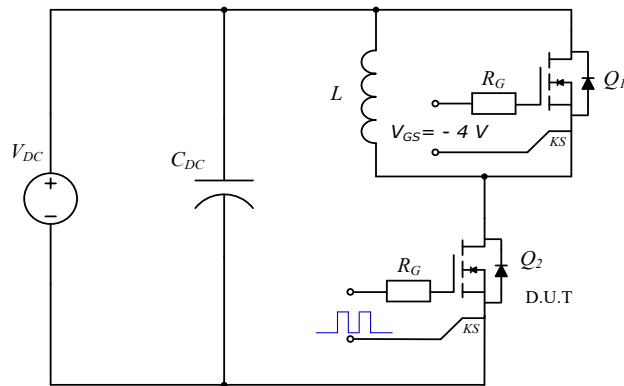
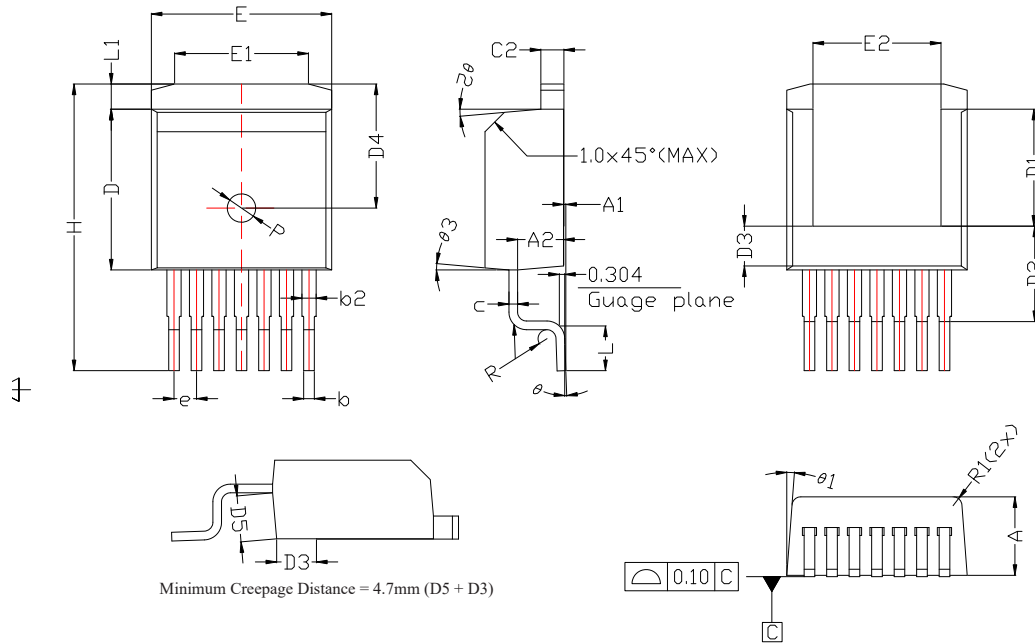

Figure 29. Clamped Inductive Switching
Waveform Test Circuit

Note (3): Turn-off and Turn-on switching energy and timing values measured using SiC MOSFET Body Diode as shown above.

Package Dimensions

TO-263-7L XL



DIM	MIN	MAX	TYP
D	9.025	9.125	9.075
E	10.13	10.23	10.18
A	4.30	4.57	4.435
H	15.043	17.313	16.178
D1	6.50	6.70	6.60
E1	6.50	8.60	7.55
D2	5.39 REF.		
E2	6.778	7.665	7.223
D3	2.148	2.248	
D4	7.00 REF.		
D5	2.555	2.605	
A1	0	0.25	0.125
A2	2.595 REF.		
e	1.27 TYP.		
L	2.324	2.70	2.512
b	0.50	0.70	0.60
L1	0.968	1.868	1.418
b2	0.60	1.00	0.80
C2	1.17	1.37	1.27
c	0.281	0.481	0.381
R	0.506 REF.		
R1	0.50 REF.		
P	Ø1.60 REF.		
θ	0°	8°	4°
θ1	4.5°	5.5°	5°
θ2	4°	6°	5°
θ3	4°	6°	5°

- NOTES:
1. ALL DIMENSIONS ARE IN MILLIMETER. ANGLES ARE IN DEGREE.
 2. DIMENSION "D" DOES NOT INCLUDE INTERLEAD FLASH OR PROTRUSIONS. INTERLEAD FLASH SHALL NOT EXCEED 0.50 MM PER SIDE. DIMENSION "E" DOES NOT INCLUDE MOLD FLASH, GATE BURRS, THE GATE BURRS SHALL NOT EXCEED 0.30MM.
 3. THE PACKAGE TOP MAY BE SMALLER THAN THE PACKAGE BOTTOM. DIMENSIONS D AND E ARE DETERMINED AT THE OUTERMOST EXTREMES OF THE PLASTIC BODY EXCLUSIVE OF MOLD FLASH, TIE BAR BURRS, GATE BURRS AND INTERLEAD FLASH, BUT INCLUDING ANY MISMATCH BETWEEN THE TOP AND BOTTOM OF THE PLASTIC BODY.
 4. "b2" DIMENSION DON'T INCLUDE DAMBAR PROTRUSION.
 5. THE VOID SHOULD BE CONTROL WITHIN 0.25MM.

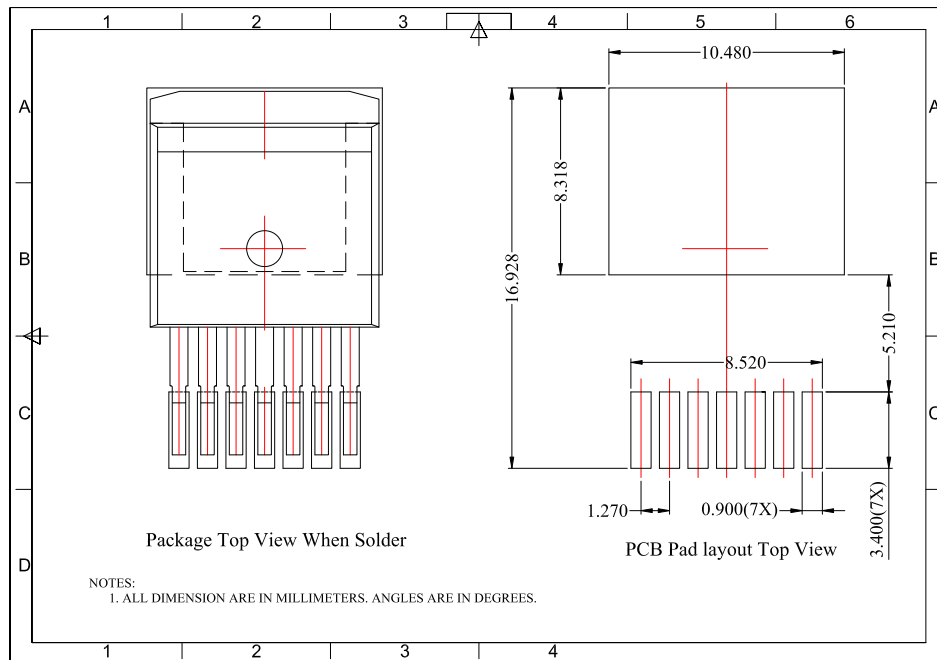

- NOTES:
1. ALL DIMENSION ARE IN MILLIMETERS. ANGLES ARE IN DEGREES.