

C6D10065E

Silicon Carbide Schottky Diode

Z-REC[®] RECTIFIER

V_{RRM}	=	650 V
$I_F (T_c=155^\circ\text{C})$	=	10 A
Q_c	=	34 nC

Features

- New 6th Generation Technology
- Low Forward Voltage Drop (V_F)
- Zero Reverse Recovery Current
- Zero Forward Recovery Voltage
- Low Leakage Current (I_L)
- Temperature-Independent Switching Behavior
- Positive Temperature Coefficient on V_F

Benefits

- Higher System Level Efficiency
- Increase System Power Density
- Reduction of Heat Sink Requirements
- Parallel Devices Without Thermal Runaway

Applications

- Switch Mode Power Supplies (SMPS)
- Server/Telecom Power Supplies
- Industrial Power Supplies
- Solar
- UPS

Package



TO-252-2



Part Number	Package	Marking
C6D10065E	TO-252-2	C6D10065

Maximum Ratings ($T_c = 25^\circ\text{C}$ unless otherwise specified)

Symbol	Parameter	Value	Unit	Test Conditions	Note
V_{RRM}	Repetitive Peak Reverse Voltage	650	V		
V_{DC}	DC Blocking Voltage	650	V		
I_F	Continuous Forward Current	35 18 10	A	$T_c=25^\circ\text{C}$ $T_c=125^\circ\text{C}$ $T_c=155^\circ\text{C}$	Fig. 3
I_{FRM}	Repetitive Peak Forward Surge Current	41 24	A	$T_c=25^\circ\text{C}, t_p = 10 \text{ ms}, \text{Half Sine Wave}$ $T_c=110^\circ\text{C}, t_p = 10 \text{ ms}, \text{Half Sine Wave}$	
I_{FSM}	Non-Repetitive Peak Forward Surge Current	78 68	A	$T_c=25^\circ\text{C}, t_p = 10 \text{ ms}, \text{Half Sine Wave}$ $T_c=110^\circ\text{C}, t_p = 10 \text{ ms}, \text{Half Sine Wave}$	Fig. 8
$I_{F,Max}$	Non-Repetitive Peak Forward Surge Current	1100 1000	A	$T_c=25^\circ\text{C}, t_p = 10 \mu\text{s}, \text{Pulse}$ $T_c=110^\circ\text{C}, t_p = 10 \mu\text{s}, \text{Pulse}$	Fig. 8
P_{tot}	Power Dissipation	99 43	W	$T_c=25^\circ\text{C}$ $T_c=110^\circ\text{C}$	Fig. 4
T_J, T_{stg}	Operating Junction and Storage Temperature	-55 to +175	$^\circ\text{C}$		

Electrical Characteristics

Symbol	Parameter	Typ.	Max.	Unit	Test Conditions	Note
V_F	Forward Voltage	1.27 1.37	1.50 1.60	V	$I_F = 10\text{ A}$ $T_J = 25^\circ\text{C}$ $I_F = 10\text{ A}$ $T_J = 175^\circ\text{C}$	Fig. 1
I_R	Reverse Current	2 15	50 200	μA	$V_R = 650\text{ V}$ $T_J = 25^\circ\text{C}$ $V_R = 650\text{ V}$ $T_J = 175^\circ\text{C}$	Fig. 2
Q_C	Total Capacitive Charge	34		nC	$V_R = 400\text{ V}$, $T_J = 25^\circ\text{C}$	Fig. 5
C	Total Capacitance	611 67 53		pF	$V_R = 0\text{ V}$, $T_J = 25^\circ\text{C}$, $f = 1\text{ MHz}$ $V_R = 200\text{ V}$, $T_J = 25^\circ\text{C}$, $f = 1\text{ MHz}$ $V_R = 400\text{ V}$, $T_J = 25^\circ\text{C}$, $f = 1\text{ MHz}$	Fig. 6
E_C	Capacitance Stored Energy	5.2		μJ	$V_R = 400\text{ V}$	Fig. 7

Note: This is a majority carrier diode, so there is no reverse recovery charge.

Thermal Characteristics

Symbol	Parameter	Typ.	Unit	Note
$R_{\theta JC}$	Thermal Resistance from Junction to Case	1.51	$^\circ\text{C}/\text{W}$	Fig. 9

Typical Performance

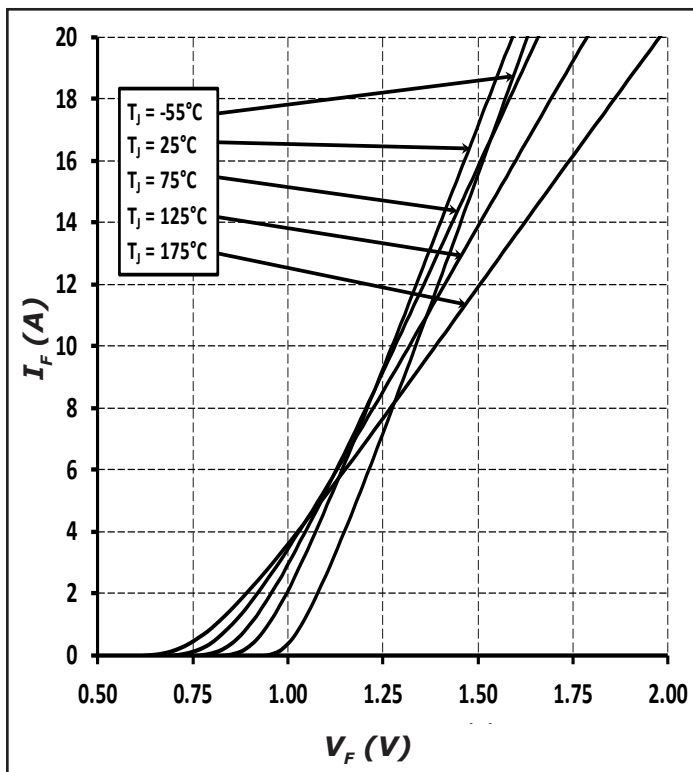

Figure 1. Forward Characteristics

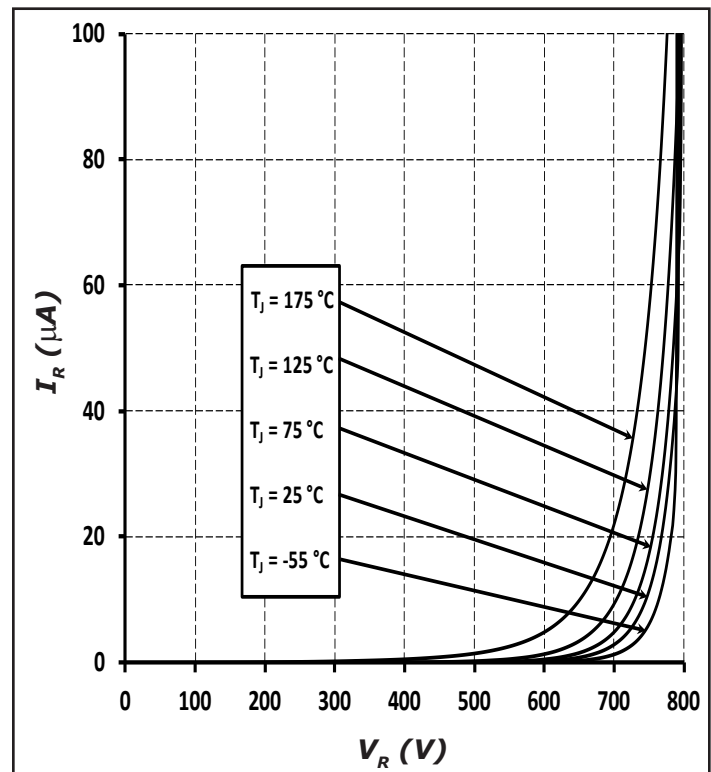

Figure 2. Reverse Characteristics

Typical Performance

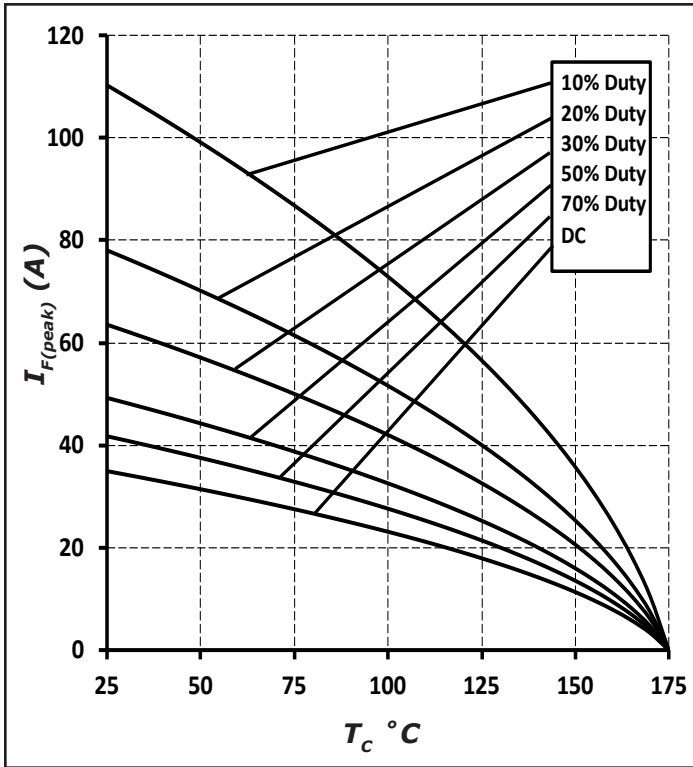

Figure 3. Current Derating

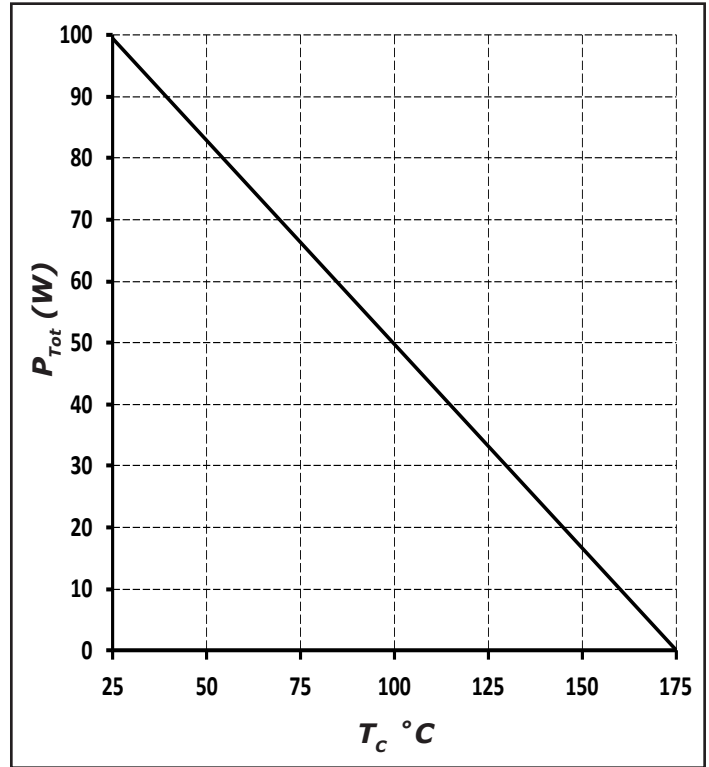

Figure 4. Power Derating

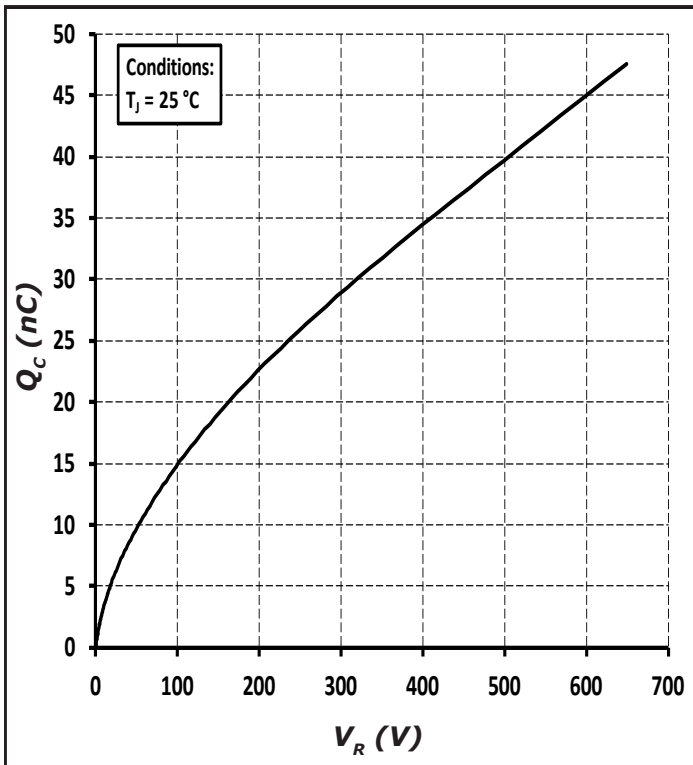

Figure 5. Total Capacitance Charge vs. Reverse Voltage

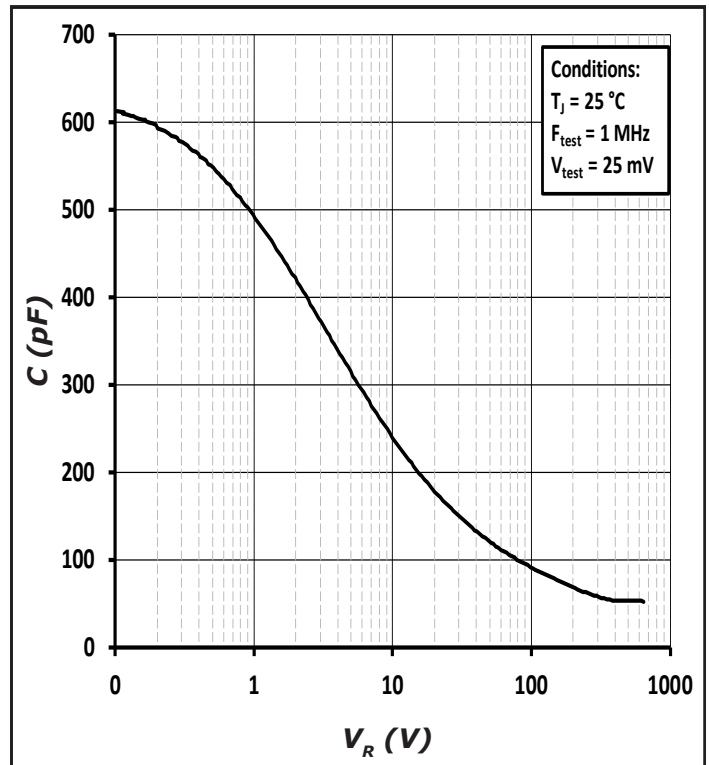

Figure 6. Capacitance vs. Reverse Voltage

Typical Performance

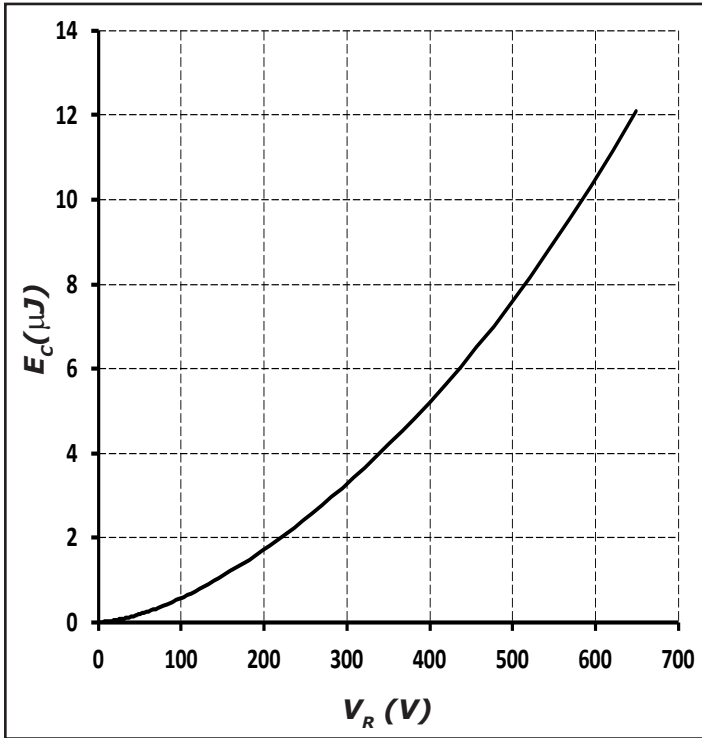

Figure 7. Capacitance Stored Energy

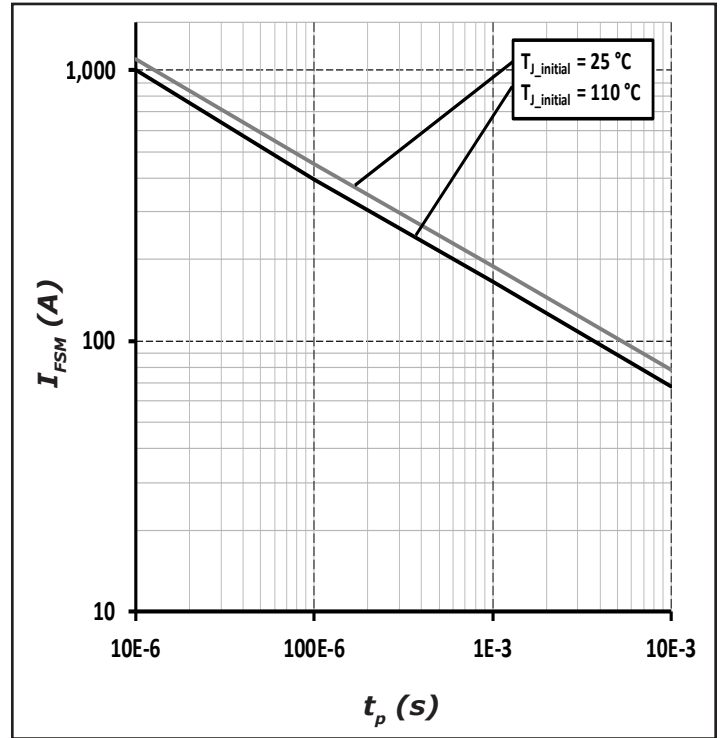

Figure 8. Non-repetitive peak forward surge current versus pulse duration (Sinusoidal Waveform)

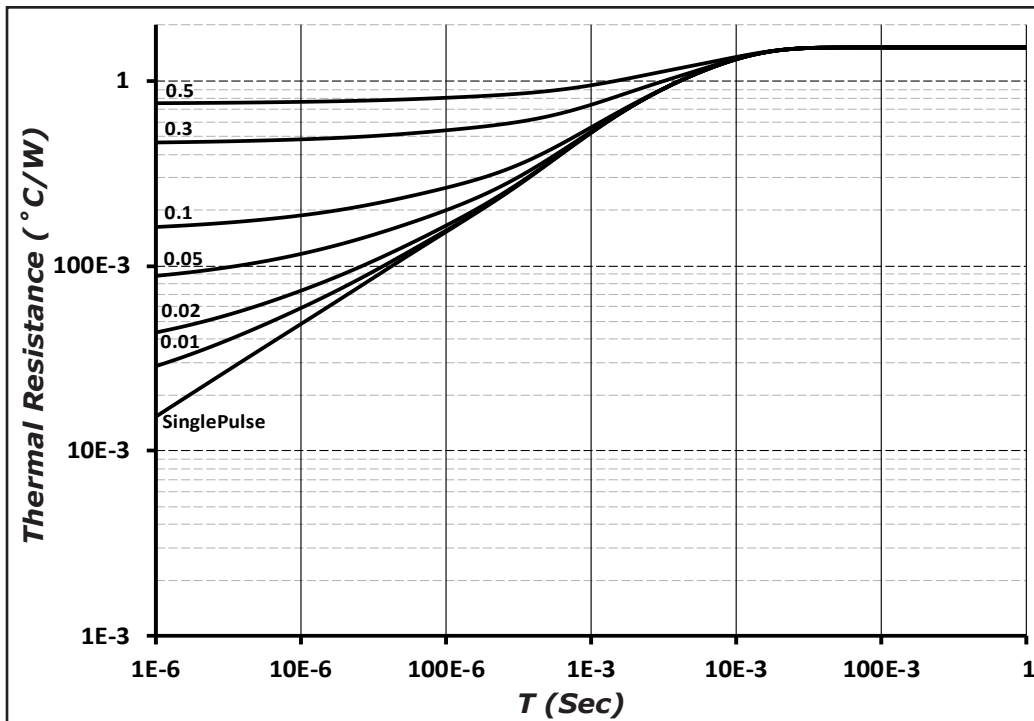
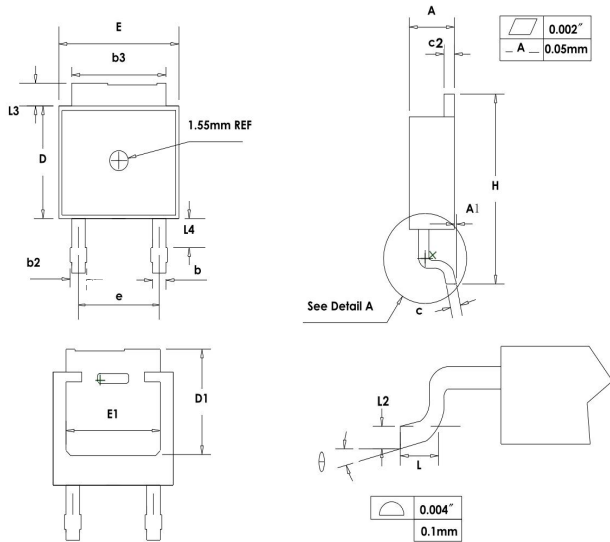

Figure 9. Transient Thermal Impedance

Package Dimensions

Package TO-252-2



SYMBOL	MILLIMETERS	
	MIN	MAX
A	2.159	2.413
A1	0	0.13
b	0.64	0.89
b2	0.653	1.143
b3	5.004	5.6
c	0.457	0.61
c2	0.457	0.864
D	5.867	6.248
D1	5.21	-
E	6.35	6.73
E1	4.32	-
e	4.58 BSC	
H	9.65	10.414
L	1.106	1.78
L2	0.51 BSC	
L3	0.889	1.27
L4	0.64	1.01
θ	0°	8°

Recommended Solder Pad Layout

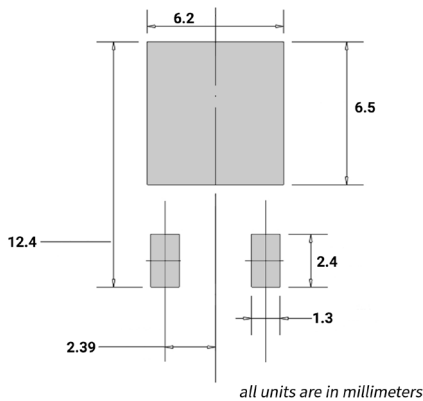

TO-252-2

Part Number	Package	Marking
C6D10065E	TO-252-2	C6D10065

Note: Recommended soldering profiles can be found in the applications note here: http://www.wolfspeed.com/power_app_notes/soldering

