

---

## C8051F700 DEVELOPMENT KIT USER'S GUIDE

---

### 1. Relevant Devices

The C8051F700 Development Kit is intended as a development platform for the microcontrollers in the C8051F70x/71x MCU family. The members of this MCU family are: C8051F700, C8051F701, C8051F702, C8051F703, C8051F704, C8051F705, C8051F706, C8051F707, C8051F708, C8051F709, C8051F710, C8051F711, C8051F712, C8051F713, C8051F714, C8051F715.

- The target board included in this kit is provided with a pre-soldered C8051F700 MCU.
- Code developed on the C8051F700 can be easily ported to the other members of this MCU family.
- Refer to the C8051F70x data sheet for the differences between the members of this MCU family.

### 2. Kit Contents

The C8051F700 Development Kit contains the following items:

- C8051F700 Target Board
- C8051Fxxx Development Kit Quick-Start Guide
- Silicon Laboratories IDE and Product Information CD-ROM. CD content includes:
  - Silicon Laboratories Integrated Development Environment (IDE)
  - Evaluation assembler, compiler and linker tools
  - Source code examples and register definition files
  - Documentation
- AC to DC universal power adapter
- USB debug adapter
- 2 USB cables

### 3. Hardware Setup

Refer to Figure 1 for a diagram of the hardware configuration.

1. Connect the USB Debug Adapter to the DEBUG connector on the target board with the 10-pin ribbon cable.
2. Connect one end of the USB cable to the USB connector on the USB Debug Adapter.
3. Verify that shorting blocks are installed on the target board as shown in Figure 1.
4. Connect the other end of the USB cable to a USB Port on the PC.
5. Connect the ac/dc power adapter to power jack P2 on the target board.

**Notes:**

- Use the **Reset** icon in the IDE to reset the target when connected during a debug session.
- Remove power from the target board and the USB Debug Adapter before connecting or disconnecting the ribbon cable from the target board. Connecting or disconnecting the cable when the devices have power can damage the device and/or the USB Debug Adapter.

# C8051F700-DK

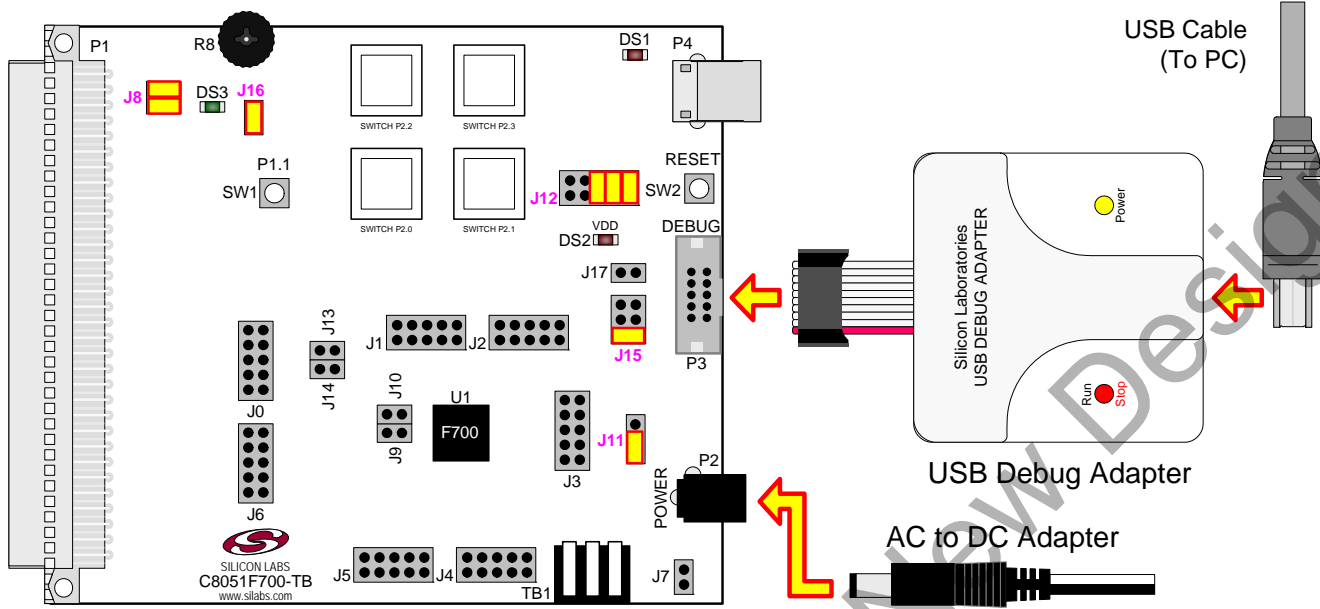

Figure 1. Hardware Setup using a USB Debug Adapter

## 4. PC Software Overview

### 4.1. CP210x USB to UART VCP Driver Installation

The C8051F700 Target Board includes a Silicon Laboratories CP2102 USB-to-UART Bridge Controller (U2). Device drivers for the CP2102 need to be installed before PC software such as HyperTerminal can communicate with the target board over the USB connection. If the "Install CP210x Drivers" option is selected during installation, a driver "unpacker" utility will launch.

1. Follow the steps to copy the driver files to the desired location. The default directory is `C:\SiLabs\MCU\CP210x`.
2. The final window will give an option to install the driver on the target system. Select the "Launch the CP210x VCP Driver Installer" option if you are ready to install the driver.
3. If selected, the driver installer will now launch, providing an option to specify the driver installation location. After pressing the "Install" button, the installer will search your system for copies of previously installed CP210x Virtual COM Port drivers. It will let you know when your system is up to date. The driver files included in this installation have been certified by Microsoft.
4. If the "Launch the CP210x VCP Driver Installer" option was not selected in step 3, the installer can be found in the location specified in step 2, by default `C:\SiLabs\MCU\CP210x\Windows_2K_XP_S2K3_Vista`. At this location run `CP210xVCPInstaller.exe`.
5. To complete the installation process, connect the included USB cable between the host computer and the USB connector (P4) on the C8051F700 Target Board. Windows will automatically finish the driver installation. Information windows will pop up from the taskbar to show the installation progress.

If needed, the driver files can be uninstalled by selecting "Silicon Laboratories CP210x USB to UART Bridge (Driver Removal)" option in the "Add or Remove Programs" window.

### 4.2. Silicon Laboratories Integrated Development Environment

The Silicon Laboratories IDE integrates a source-code editor, source-level debugger and in-system programmer. The use of third-party compilers, assemblers, and linkers is also supported. This development kit includes evaluation versions of commercial C compilers and assemblers which can be used from within the Silicon Laboratories IDE.

## 4.3. System Requirements

The Silicon Laboratories IDE requirements:

- Pentium-class host PC running Windows 2000 or later.
- One available USB port.

## 4.4. Third-Party Toolsets

The Silicon Laboratories IDE has native support for many 8051 compilers. Natively-supported tools are as follows:

- Keil
- IAR
- Raisonance
- Tasking
- Hi-Tech
- SDCC

Specific instructions for integrating each of the supported tools can be found in the application notes section of the CD, or on the Silicon Labs web site (<http://www.silabs.com>).

## 4.5. Getting Started With the Silicon Labs IDE

The following sections discuss how to create a new project with the IDE, build the source code, and download it to the target device.

### 4.5.1. Creating a New Project

1. Select **Project**→**New Project** to open a new project and reset all configuration settings to default.
2. Select **File**→**New File** to open an editor window. Create your source file(s) and save the file(s) with a recognized extension, such as .c, .h, or .asm, to enable color syntax highlighting.
3. Right-click on “New Project” in the **Project Window**. Select **Add files to project**. Select files in the file browser and click Open. Continue adding files until all project files have been added.
4. For each of the files in the **Project Window** that you want assembled, compiled and linked into the target build, right-click on the file name and select **Add file to build**. Each file will be assembled or compiled as appropriate (based on file extension) and linked into the build of the absolute object file.

**Note:** If a project contains a large number of files, the “Group” feature of the IDE can be used to organize. Right-click on “New Project” in the **Project Window**. Select **Add Groups to project**. Add pre-defined groups or add customized groups. Right-click on the group name and choose **Add file to group**. Select files to be added. Continue adding files until all project files have been added.

### 4.5.2. Building and Downloading the Program for Debugging

1. Once all source files have been added to the target build, build the project by clicking on the **Build/Make Project** button in the toolbar or selecting **Project**→**Build/Make Project** from the menu.

**Note:** After the project has been built the first time, the **Build/Make Project** command will only build the files that have been changed since the previous build. To rebuild all files and project dependencies, click on the **Rebuild All** button in the toolbar or select **Project**→**Rebuild All** from the menu.

2. Before connecting to the target device, several connection options may need to be set. Open the **Connection Options** window by selecting **Options**→**Connection Options...** in the IDE menu. First, select the “USB Debug Adapter” option. Next, the correct “Debug Interface” must be selected. C8051F700 devices use Silicon Labs “C2” 2-wire debug interface. Once all the selections are made, click the **OK** button to close the window.
3. Click the **Connect** button in the toolbar or select **Debug**→**Connect** from the menu to connect to the device.
4. Download the project to the target by clicking the **Download Code** button in the toolbar.

**Note:** To enable automatic downloading if the program build is successful select **Enable automatic connect/download after build** in the **Project→Target Build Configuration** dialog. If errors occur during the build process, the IDE will not attempt the download.

5. Save the project when finished with the debug session to preserve the current target build configuration, editor settings and the location of all open debug views. To save the project, select **Project→Save Project As...** from the menu. Create a new name for the project and click on **Save**.

## 5. Example Source Code

Example source code and register definition files are provided in the “*SiLabs\MCU\Examples\C8051F70x\_71x*” directory during IDE installation. These files may be used as a template for code development. The comments in each example file indicate which development tool chains were used when testing.

### 5.1. Register Definition Files

Register definition files *C8051F70x.inc*, *C8051F70x\_defs.h* and *compiler\_defs.h* define all SFR registers and bit-addressable control/status bits. They are installed into the “*SiLabs\MCU\Examples\C8051F70x\_71x*” directory during IDE installation. The register and bit names are identical to those used in the C8051F70x datasheet.

### 5.2. Blinking LED Example

The example source files *F70x\_Blinky.asm* and *F70x\_Blinky.c* installed in the default directory “*SiLabs\MCU\Examples\C8051F70x\_71x\Blinky*” show examples of several basic C8051F700 functions. These include disabling the watchdog timer (WDT), configuring the Port I/O crossbar, configuring a timer for an interrupt routine, initializing the system clock, and configuring a GPIO port pin. When compiled/assembled and linked this program flashes the green LED (DS3) on the C8051F700 Target Board about five times a second using the interrupt handler with a C8051F700 timer.

### 5.3. Capacitive Sense Switch Example

The example source file *F70x\_CS0.c* demonstrates the configuration and usage of the capacitive sense switches located on P2.0 through P2.3. Refer to the source file for step-by-step instructions to build and test this example. This is installed in the “*SiLabs\MCU\Examples\C8051F70x\_71x\CS0*” directory by default.

## 6. Target Board

The C8051F700 Development Kit includes a target board with a C8051F700 device pre-installed for evaluation and preliminary software development. Numerous input/output (I/O) connections are provided to facilitate prototyping using the target board. Refer to Figure 2 for the locations of the various I/O connectors. Figure 2 shows the factory default shorting block positions.

DS1	LED indicates that the USB connection is providing power to the USB to UART device U2
DS2	LED indicates whether power is being supplied through selection made on J15
DS3	LED connects to P1.0 through J8
P1	Expansion connector (96-pin)
P2	Power connector (accepts input from 7 to 15 VDC unregulated power adapter)
P3	DEBUG connector for Debug Adapter interface
P4	USB connector (connects to PC for serial communication)
J0 - J6	Port I/O headers (provide access to Port I/O pins)
J7	Provides easily accessible ground clip
J8	Connects P1.0 to LED DS3 and P1.1 to switch SW1
J9	Connects P0.2 (XTAL1) to one terminal of Y1
J10	Connects P0.3 (XTAL2) to one terminal of Y1
J11	Selects either on-board regulator or USB debug adapter as VDD_LDO power source
J12	Connects port I/O to the UART0 interface
J13	Connects P0.0/VREF to bypass capacitor
J14	Connects P0.1/AGND to GND
J15	Selects one of the available power sources as the board supply
J16	Connects P1.2 to potentiometer R8
SW1	Switch connected to the MCU I/O pin P1.1
SW2	Switch connected to the reset pin of the MCU
TB1	Analog I/O terminal block

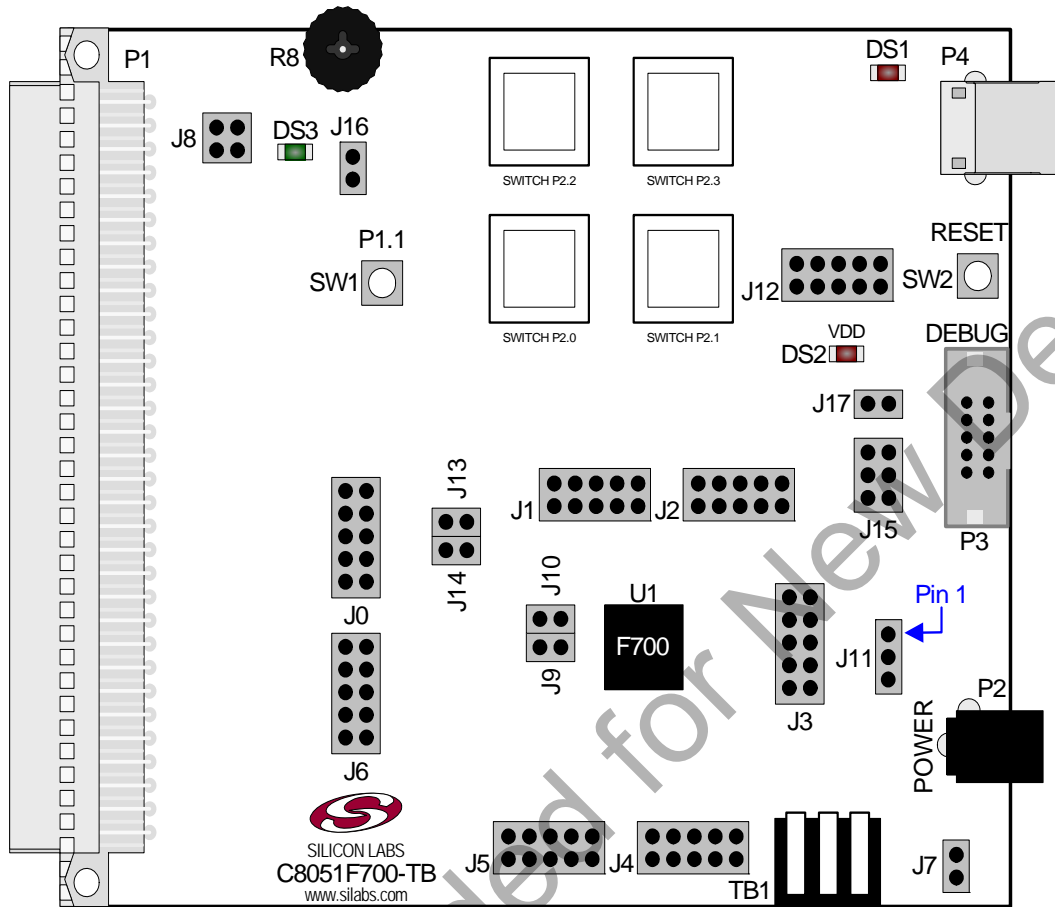

Figure 2. C8051F700 Target Board

# C8051F700-DK

## 6.1. Target Board Shorting Blocks: Factory Defaults

The C8051F700 target board comes from the factory with pre-installed shorting blocks on many headers. Figure 3 shows the positions of the factory default shorting blocks.

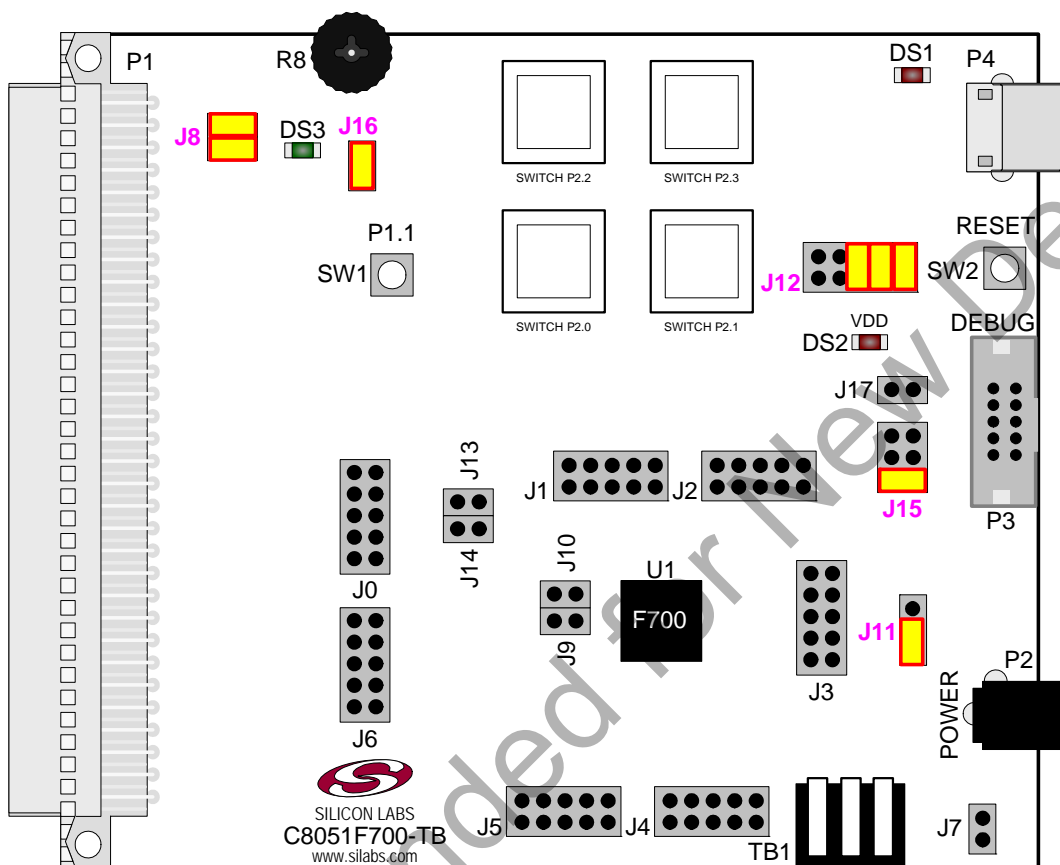

Figure 3. C8051F700 Target Board Shorting Blocks: Factory Defaults



## 6.2. Target Board Power Options and Current Measurement

The C8051F700 Target Board supports three power options, selectable by placing a shorting block on J15. The power options are described in the paragraphs below.

### 6.2.1. Wall Power and Debug Power

Placing a shorting block on J15 that connects VDD\_LDO to VDD configures the board to be powered from the output of the on-board regulator to power the device.



Place a shorting block on J3 between pins 2 and 3 in order to route supply from power jack P2 into the on-board LDO.

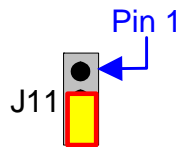

Place a shorting block on J3 between pins 1 and 2 in order to route supply from the debug adapter (P3) into the on-board LDO.

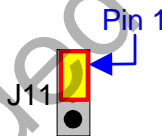

### 6.2.2. External Supply

Placing a shorting block on J15 that connects VDD\_EXT to VDD configures the board to be powered from a voltage connected to the VDD\_EXT input of TB1.

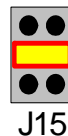

### 6.2.3. USB Power

Placing a shorting block on J15 that connects VDD\_USB to VDD configures the board to be powered from the output of U2's on-chip regulator.



## 6.3. System Clock Sources

### 6.3.1. Internal Oscillator

The C8051F700 devices feature a calibrated internal oscillator which is enabled as the system clock source on reset. After reset, the internal oscillator operates at a frequency of 24.5 MHz ( $\pm 2\%$ ) by default, but may be configured by software to operate at other frequencies. Therefore, in many applications an external oscillator is not required. However, if you wish to operate the C8051F700 device at a frequency not available with the internal oscillator, an external oscillator source may be used. Refer to the C8051F70x datasheet for more information on configuring the system clock source.

### 6.3.2. External Oscillator Options

The main board is designed to facilitate the use of external clock sources. To use an external CMOS clock source, the clock can simply be applied to P0.3. For RC and C modes, place a shorting block on header J10. To implement the RC mode option, placeholders for an 0805-packaged capacitor (C17) and resistor (R14) are supplied on the board. The C (capacitor) clock option can be implemented by using only the capacitor placeholder (C17). To reduce the amount of stray capacitance on the pin, which could affect the frequency in either RC or C mode, resistor R13 can also be removed from the board when using C or RC mode. To implement external crystal mode, place shorting blocks at headers J9 and J10 and install the crystal at the pads marked Y1. Install a 10 M $\Omega$  resistor at R13 and install capacitors at C17 and C18 using values appropriate for the crystal you select. Refer to the C8051F700 datasheet for more information on the use of external oscillators.

## 6.4. Switches and LEDs

Two push-button switches are provided on the main board. Switch RESET is connected to the RESET pin of the C8051F700. Pressing RESET puts the device into its hardware-reset state. Switch SW1 P1.1 can be connected to the C8051F700's general purpose I/O (GPIO) pin P1.0 through header J8. Pressing Switch SW1 P1.1 generates a logic low signal on the port pin. Remove the shorting block from the J8 header to disconnect Switch SW1 P1.1 from the port pin.

Four capacitive sense switches are provided on the target board. The operation of these switches require appropriate firmware running on the C8051F700 MCU that can sense the state of the switch. See Section "5.3. Capacitive Sense Switch Example" on page 5 for details about example source code.

Three LEDs are also provided on the target board. The red LED labeled USB PWR (DS1) is used to indicate a USB connection to P4. The red LED labeled DS2 indicates when power is being applied to the board through J15. Finally, the green LED labeled P1.0 (DS2) can be connected to the C8051F700's GPIO pin P1.0 through header J8. Remove the shorting block from the header to disconnect the LED from the port pin.

See Table 1 for the port pins and headers corresponding to the switches and LEDs.

**Table 1. Target Board I/O Descriptions**

Description	Label	I/O	Header
Push-button Switch	SW1	P1.1	J8
Push-button Switch	SW2	RESET	none
Capacitive Sense Switch	C1	P2.0	none
Capacitive Sense Switch	C2	P2.1	none
Capacitive Sense Switch	C3	P2.2	none
Capacitive Sense Switch	C4	P2.3	none
Green LED	DS3	P1.0	J8
Red LED	DS2	VDD	none
Red LED	DS1	5V_VBUS	none

## 6.5. Target Board DEBUG Interface (DEBUG / P3)

The DEBUG connector J9 provides access to the DEBUG (C2) pins of the C8051F700. It is used to connect the Serial Adapter or the USB Debug Adapter to the target board for in-circuit debugging and Flash programming. Table 2 shows the DEBUG pin definitions.

**Table 2. Debug Connector (P3) Description**

Pin #	Description
1	VDD_F700 (+3.3 VDC)
2, 3, 9	GND (Ground)
4	C2D
5	/RST (Reset)
6	Not connected
7	/RST/C2CK
8	Not connected
10	USB Power (+5 VDC)

## 6.6. Port I/O Connectors (J0-J6)

Each of the parallel ports of the C8051F700 has its own 10-pin header connector. Each connector provides a pin for the corresponding port pins 0-7, VDD, and digital ground. The same pin-out is used for all of the port connectors, and is shown in Table 3 .

**Table 3. Port I/O Connector Pin Description**

Pin #	Pin Description
1	Pn.0
2	Pn.1
3	Pn.2
4	Pn.3
5	Pn.4
6	Pn.5
7	Pn.6
8	Pn.7
9	VDD (VDD_F700)
10	GND (Ground)

## 6.7. Serial Interface (P4)

A USB-to-UART bridge circuit (U2) and USB connector (P4) are provided on the target board to facilitate serial connections to UART0 of the C8051F700. The Silicon Labs CP2103 USB-to-UART bridge provides data connectivity between the C8051F700 and the PC via a USB port. The TX and RX signals of UART0 may be connected to the CP2102 by installing shorting blocks on header J17. The shorting block between VDD and VIO on header J12[1-2] is required when using this interface. Optionally, firmware can use I/O pins for hardware handshaking (/RTS and /CTS). The shorting block positions for connecting each of these signals to the CP2103 are listed in Table 4. To use this interface, the USB-to-UART device drivers should be installed as described in Section "4.1. CP210x USB to UART VCP Driver Installation" on page 3.

**Table 4. Serial Interface Header (J12) Description**

Header Pins	MCU I/O Pin	CP2103 Pin
J12[1-2]	none	Board VDD to CP2103 VIO
J12[3-4]	P0.5	TXD
J12[5-6]	P0.4	RXD
J12[7-8]	P0.6	/RTS
J12[9-10]	P0.7	/CTS

## 6.8. Voltage Reference (VREF) and Analog Ground Connectors (J13 and J14)

The VREF connector can be used to connect the VREF pin from the MCU (P0.0) to external 0.1  $\mu$ F and 4.7  $\mu$ F decoupling capacitors. The C8051F700 device is connected to the capacitors through the J13 header. The AGND pin from the MCU (P0.1) can be connected to the board digital ground through the J14 header.

## 6.9. Potentiometer (J16)

The C8051F700 device has the option to connect port pin P1.2 to a 10 k $\Omega$  linear potentiometer. The potentiometer is connected through the J16 header. The potentiometer can be used for testing the analog-to-digital (ADC) converter of the MCU.

## 6.10. C2 Pin Sharing

On the C8051F700, the debug pin C2CK is shared with the /RST pin. The target board includes the resistor necessary to enable pin sharing which allows the pin-shared /RST to be used normally while simultaneously debugging the device. See Application Note “AN124: Pin Sharing Techniques for the C2 Interface” at [www.silabs.com](http://www.silabs.com) for more information regarding pin sharing.

## 6.11. Expansion Connector (P1)

The 96-pin expansion I/O connector P1 is used to connect daughter boards to the main target board. P1 provides access to all of the C8051F700 pins. Pins for VDD and GND are also available. See Table 5 for a complete list of pins available at P1.

The P1 socket connector is manufactured by Hirose Electronic Co. Ltd, part number PCN13-96S-2.54DS, Digi-Key part number H7096-ND. The corresponding plug connector is also manufactured by Hirose Electronic Co. Ltd, part number PCN10-96P-2.54DS, Digi-Key part number H5096-ND.

**Table 5. P1 Pin Listing**

Pin #	Description	Pin #	Description	Pin #	Description
A-1	VDD_F700	B-1	GND	C-1	N/C
A-2	N/C	B-2	N/C	C-2	N/C
A-3	N/C	B-3	N/C	C-3	N/C
A-4	N/C	B-4	N/C	C-4	N/C
A-5	P2.7	B-5	P2.6	C-5	P2.5
A-6	P2.4	B-6	P2.3	C-6	P2.2
A-7	P2.1	B-7	P2.0	C-7	P1.7
A-8	P1.6	B-8	P1.5	C-8	P1.4
A-9	P1.3	B-9	P1.2	C-9	P1.1
A-10	P1.0	B-10	P0.7	C-10	P0.6
A-11	P0.5	B-11	P0.4	C-11	P0.3
A-12	P0.2	B-12	P0.1	C-12	P0.0
A-13	P5.7	B-13	P5.6	C-13	P5.5
A-14	P5.4	B-14	P5.3	C-14	P5.2
A-15	P5.1	B-15	P5.0	C-15	P4.7
A-16	P4.6	B-16	P4.5	C-16	P4.4
A-17	P4.3	B-17	P4.2	C-17	P4.1
A-18	P4.0	B-18	P3.7	C-18	P3.6
A-19	P3.5	B-19	P3.4	C-19	P3.3
A-20	P3.2	B-20	P3.1	C-20	P3.0
A-21	P6.0	B-21	P6.1	C-21	P6.2
A-22	P6.3	B-22	P6.4	C-22	P6.5
A-23	N/C	B-23	N/C	C-23	N/C
A-24	C2D	B-24	N/C	C-24	N/C
A-25	RST/C2CK	B-25	GND	C-25	N/C
A-26	GND	B-26	N/C	C-26	N/C
A-27	N/C	B-27	N/C	C-27	N/C
A-28	N/C	B-28	VDD_F700	C-28	N/C
A-29	N/C	B-29	N/C	C-29	N/C
A-30	N/C	B-30	N/C	C-30	N/C
A-31	N/C	B-31	N/C	C-31	N/C
A-32	N/C	B-32	GND	C-32	N/C

## 7. Schematics

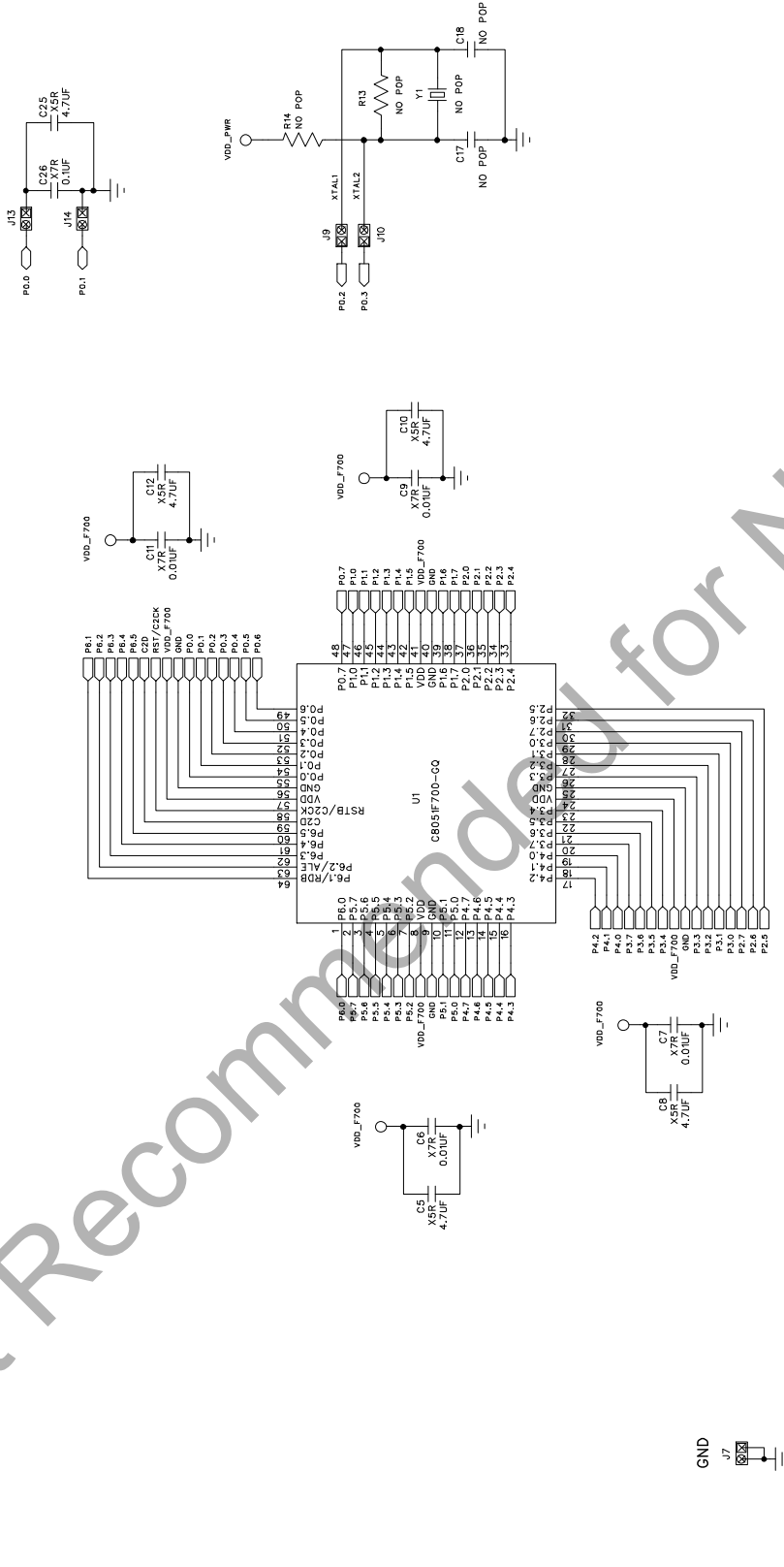

Figure 4. C8051F700 Target Board Schematic (Page 1 of 3)

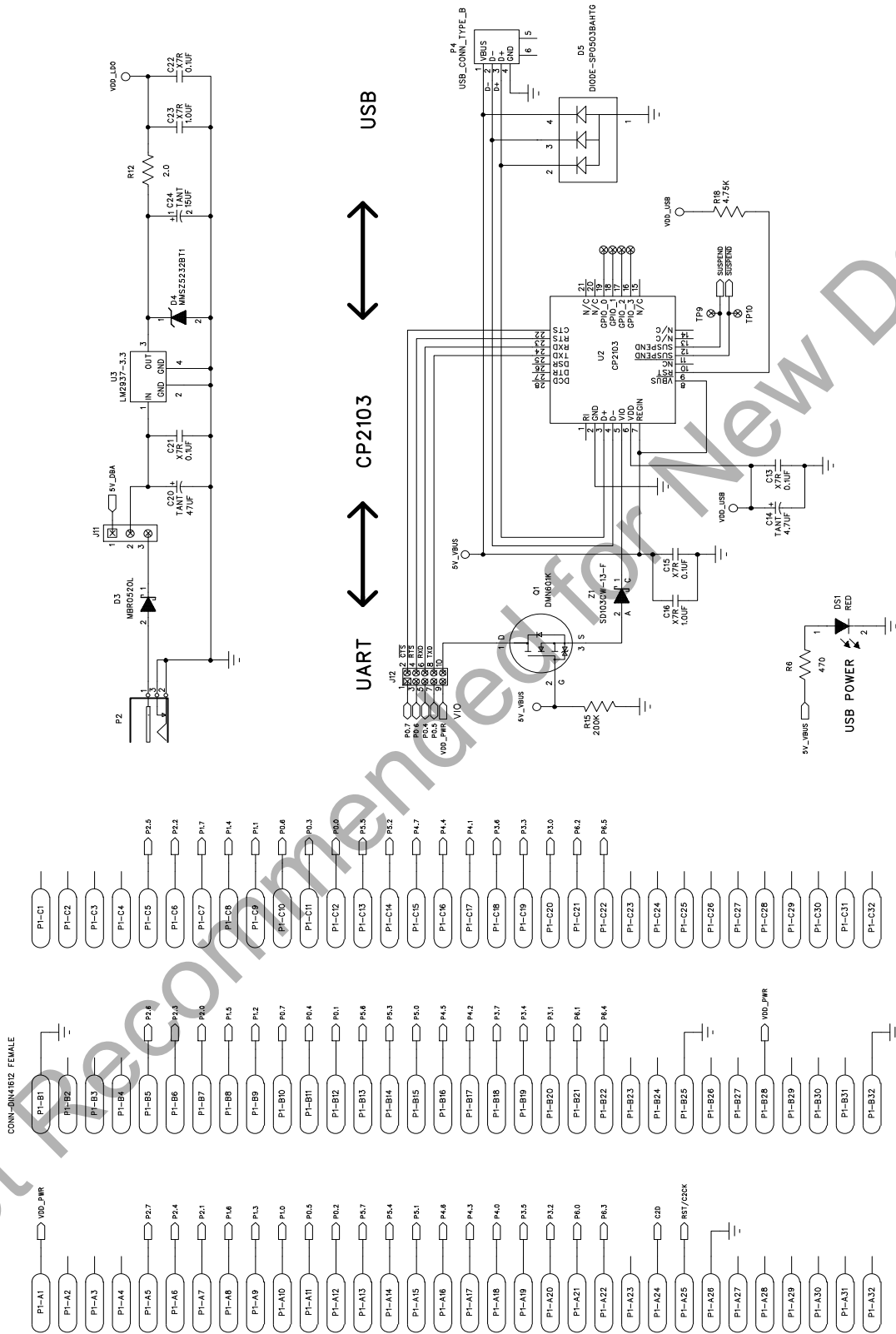

Figure 5. C8051F700 Target Board Schematic (Page 2 of 3)





## DOCUMENT CHANGE LIST

### Revision 0.2 to Revision 0.3

- Removed QuickSense references.

Not Recommended for New Designs