

TINA3-W

~40° wide beam optimized for CREE XP-E.
Assembly with holder, installation tape and
location pins.

SPECIFICATION:

Dimensions	Ø 16.1 mm
Height	6.9 mm
Fastening	tape, pin
ROHS compliant	yes ⓘ



MATERIALS:

Component	Type	Material	Colour	Finish
TINA3-W	Single lens	PMMA	clear	
TINA3-HLD-PIN-TAPE-XP	Holder	PC	white	
TINA-TAPE3	Tape	Acrylic foam	black	

ORDERING INFORMATION:

Component		Qty in box	MOQ	MPQ	Box weight (kg)
FA11824_TINA3-W	Single lens	2016	288	288	3.2
» Box size:					

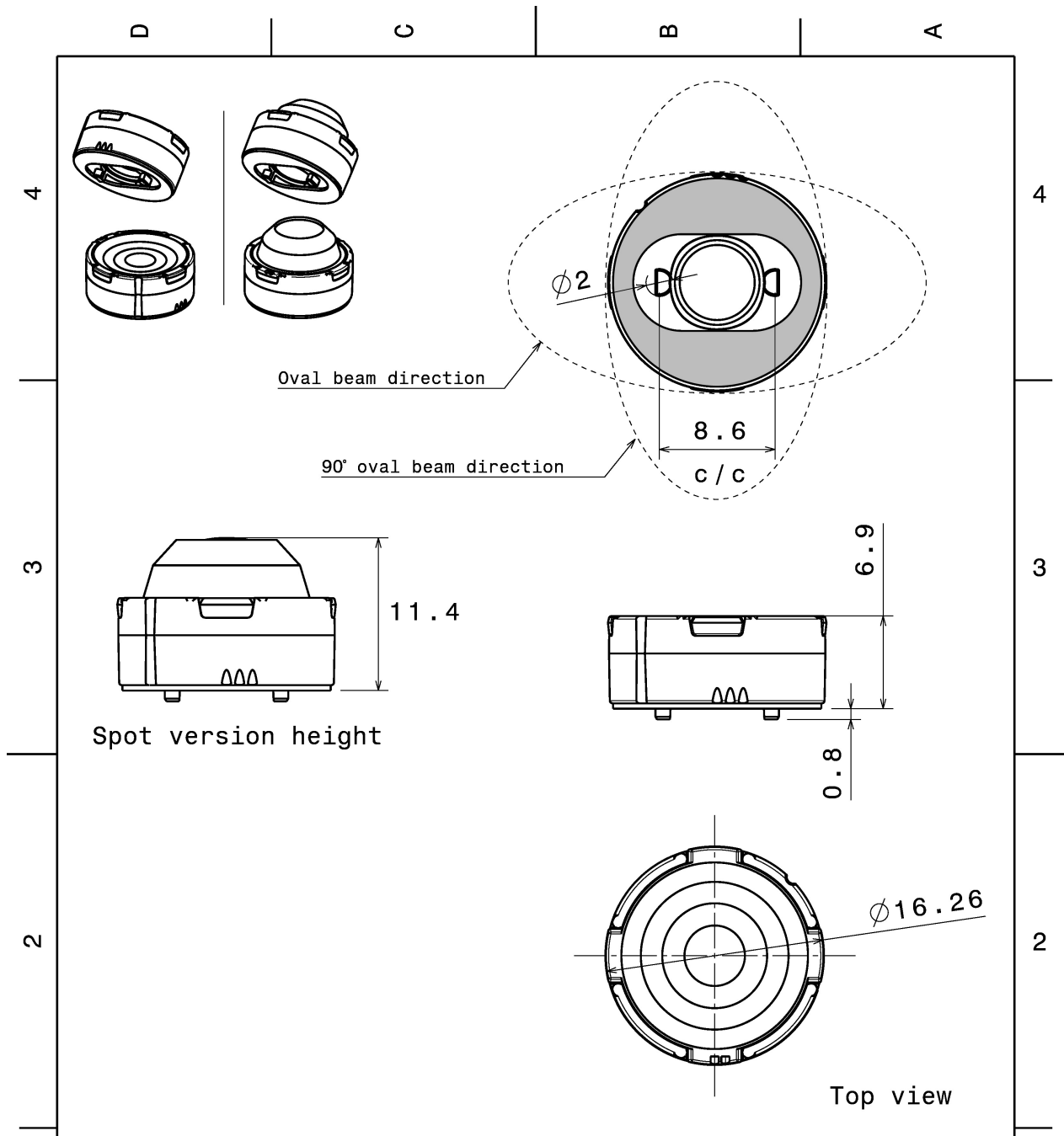

Tolerances if not otherwise shown
According to DIN ISO 2768-1
Linear measures:
Up to 30mm class F, otherwise class M.
According to DIN ISO 2768-2
Form and position: class K

LEDiL LediL Oy
Salorankatu 10
FIN 24240 SALO
Finland

THIRD ANGLE PROJECTION:

DRAWING TITLE
TINA3 Datasheet

This drawing is the property of LEDiL Oy. It may not be reproduced, copied or communicated without a written agreement with LEDiL Oy."

SIZE	PART NUMBER
A4	-

SCALE	4:3	WEIGHT	-	SHEET	1/1
-------	-----	--------	---	-------	-----

See also our general installation guide: www.ledil.com/installation_guide

OPTICAL RESULTS (MEASURED):



LED XB-D
 FWHM / FWTM 40.0° / 64.0°
 Efficiency 91 %
 Peak intensity 1.5 cd/m
 LEDs/each optic 1
 Light colour White
 Required components:



LED XP-E
 FWHM / FWTM 41.0° / 60.0°
 Efficiency 93 %
 Peak intensity 1.8 cd/m
 LEDs/each optic 1
 Light colour White
 Required components:



LED XP-G
 FWHM / FWTM 32.0° / 64.0°
 Efficiency 93 %
 Peak intensity 1.5 cd/m
 LEDs/each optic 1
 Light colour White
 Required components:



LED XP-L HI
 FWHM / FWTM 43.0° / 68.0°
 Efficiency 91 %
 Peak intensity 1.6 cd/m
 LEDs/each optic 1
 Light colour White
 Required components:

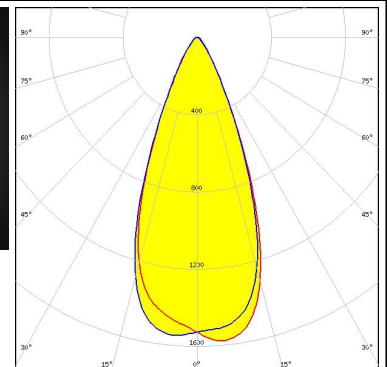
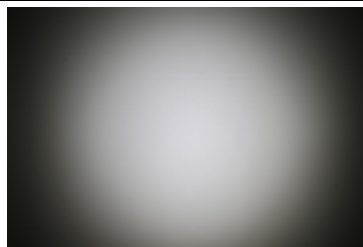

OPTICAL RESULTS (MEASURED):

LUMILEDS

LED LUXEON A
FWHM / FWTM 44.0° / 72.0°
Efficiency 90 %
Peak intensity 1.4 cd/lm
LEDs/each optic 1
Light colour White
Required components:

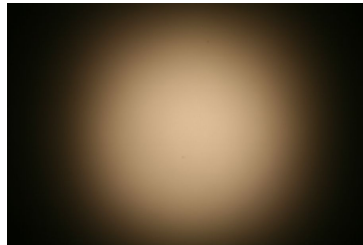

LUMILEDS

LED LUXEON Rebel
FWHM / FWTM 38.0° / 62.0°
Efficiency 83 %
Peak intensity 1.7 cd/lm
LEDs/each optic 1
Light colour White
Required components:

LUMILEDS

LED LUXEON Rebel ES
FWHM / FWTM 45.0° / 68.0°
Efficiency 91 %
Peak intensity 1.3 cd/lm
LEDs/each optic 1
Light colour White
Required components:

NICHIA

LED NVSxx19A
FWHM / FWTM 41.0° / 68.0°
Efficiency 93 %
Peak intensity 1.4 cd/lm
LEDs/each optic 1
Light colour White
Required components:

OPTICAL RESULTS (MEASURED):

OSRAM
Opto Semiconductors

LED OSOLON SSL 150
 FWHM / FWTM 37.0° / 60.0°
 Efficiency 89 %
 Peak intensity 2 cd/lm
 LEDs/each optic 1
 Light colour White
 Required components:



SEOUL SEMICONDUCTOR

LED Z5
 FWHM / FWTM 38.0° / 76.0°
 Efficiency 92 %
 Peak intensity 1.6 cd/lm
 LEDs/each optic 1
 Light colour White
 Required components:

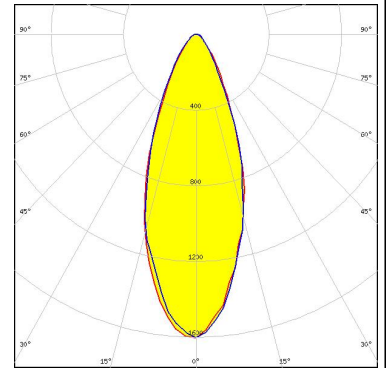

SEOUL SEMICONDUCTOR

LED Z5M1/Z5M2
 FWHM / FWTM 48.0° / 74.0°
 Efficiency 90 %
 Peak intensity 1.4 cd/lm
 LEDs/each optic 1
 Light colour White
 Required components:

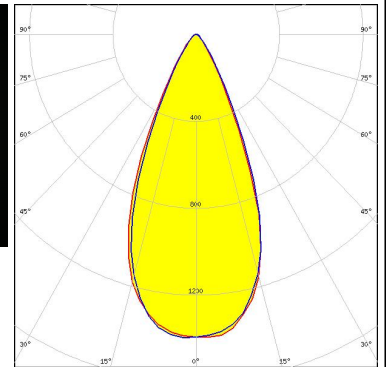
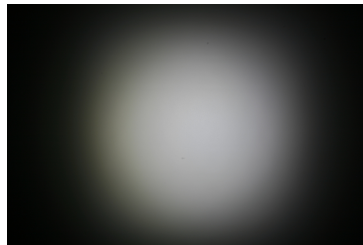

OPTICAL RESULTS (SIMULATED):

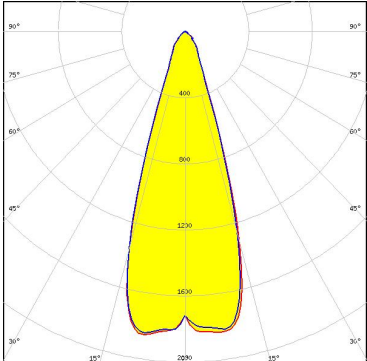
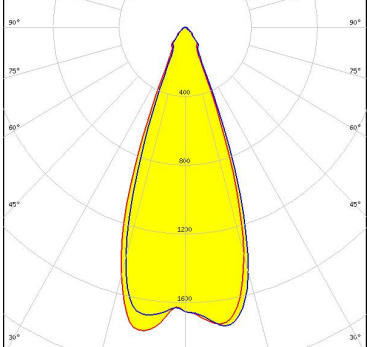
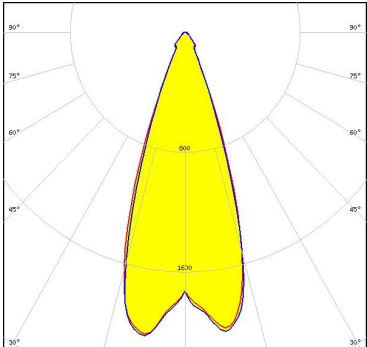
<p>NICHIA</p> <p>LED: NCSxE17A FWHM / FWTM: 36.0° / 58.0° Efficiency: 81 % Peak intensity: 1.9 cd/lm LEDs/each optic: 1 Light colour: White Required components:</p>	
<p>NICHIA</p> <p>LED: NCSxx19A FWHM / FWTM: 39.0° / 56.0° Efficiency: 91 % Peak intensity: 1.8 cd/lm LEDs/each optic: 1 Light colour: White Required components:</p>	
<p>OSRAM Opto Semiconductors</p> <p>LED: SYNIOS S2222 FWHM / FWTM: 38.0 + 36.0° / 54.0° Efficiency: 96 % Peak intensity: 2 cd/lm LEDs/each optic: 1 Light colour: White Required components:</p>	
<p>SEOL SEOUL SEMICONDUCTOR</p> <p>LED: Z8Y22P FWHM / FWTM: 42.0° Efficiency: 94 % Peak intensity: 1.6 cd/lm LEDs/each optic: 1 Light colour: White Required components:</p>	