

TINA3-WW

~55° wide beam. Assembly with holder and installation tape.

SPECIFICATION:

Dimensions	Ø 16.1 mm
Height	7.3 mm
Fastening	tape
ROHS compliant	yes ⓘ

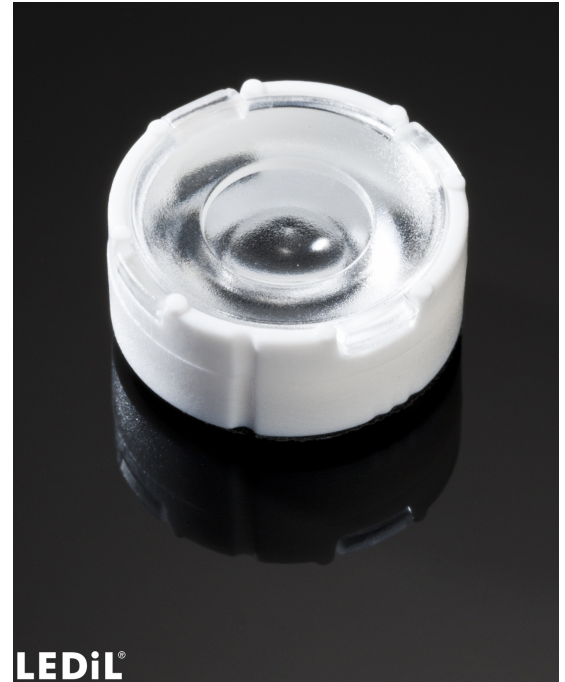

MATERIALS:

Component	Type	Material	Colour	Finish
TINA3-WW	Single lens	PMMA	clear	
TINA3-HLD-TAPE	Holder	PC	white	
TINA-TAPE3	Tape	Acrylic foam	black	

ORDERING INFORMATION:

Component	Type	Qty in box	MOQ	MPQ	Box weight (kg)
CA12892_TINA3-WW	Single lens	5750	230	230	8.3
» Box size: 451 x 241 x 298 mm					

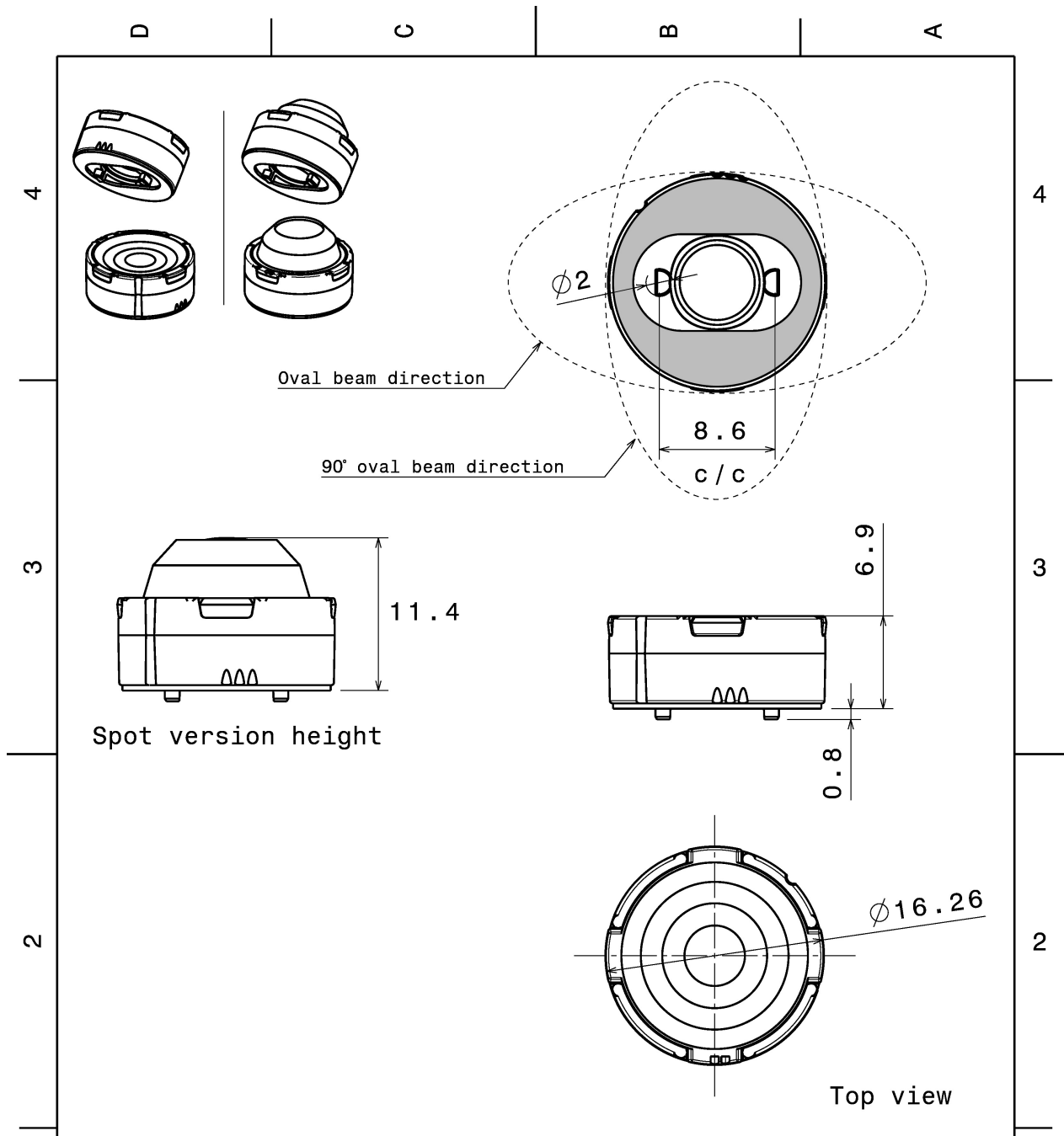

Tolerances if not otherwise shown
According to DIN ISO 2768-1
Linear measures:
Up to 30mm class F, otherwise class M.
According to DIN ISO 2768-2
Form and position: class K

LEDiL Ledil Oy
Salorankatu 10
FIN 24240 SALO
Finland

THIRD ANGLE PROJECTION:

DRAWING TITLE
TINA3 Datasheet



This drawing is the property of LEDiL Oy. It may not be reproduced, copied or communicated without a written agreement with LEDiL Oy."

SIZE	PART NUMBER
A4	-

SCALE	4:3	WEIGHT	-	SHEET	1/1
-------	-----	--------	---	-------	-----

See also our general installation guide: www.ledil.com/installation_guide

OPTICAL RESULTS (MEASURED):

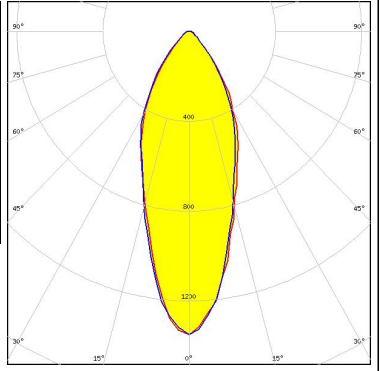
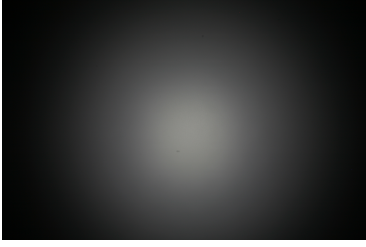
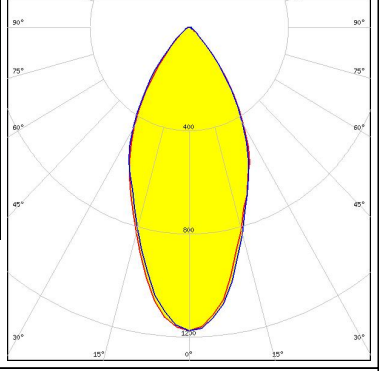
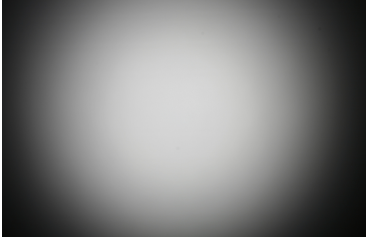
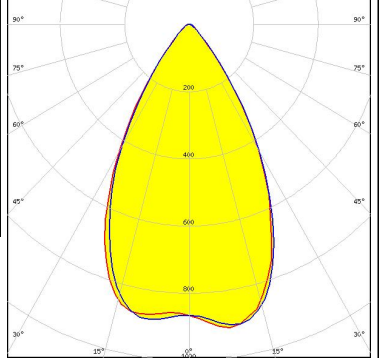
<p>CREE LEDs</p> <p>LED XHP35 HI FWHM / FWTM 61.0° / 92.0° Efficiency 88 % Peak intensity 0.9 cd/m LEDs/each optic 1 Light colour White Required components:</p>		
<p>CREE LEDs</p> <p>LED XP-E FWHM / FWTM 39.0° / 86.0° Efficiency 93 % Peak intensity 1.4 cd/m LEDs/each optic 1 Light colour White Required components:</p>		
<p>CREE LEDs</p> <p>LED XP-G FWHM / FWTM 50.0° / 88.0° Efficiency 93 % Peak intensity 1.2 cd/m LEDs/each optic 1 Light colour White Required components:</p>		
<p>CREE LEDs</p> <p>LED XP-G2 FWHM / FWTM 59.0° / 88.0° Efficiency 90 % Peak intensity 0.9 cd/m LEDs/each optic 1 Light colour White Required components:</p>		

OPTICAL RESULTS (MEASURED):



LED XP-L HI
 FWHM / FWTM 61.0° / 89.0°
 Efficiency 89 %
 Peak intensity 0.9 cd/lm
 LEDs/each optic 1
 Light colour White
 Required components:

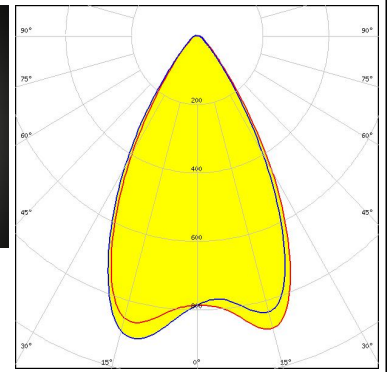

LED XT-E
 FWHM / FWTM 40.0° / 84.0°
 Efficiency 93 %
 Peak intensity 1.4 cd/lm
 LEDs/each optic 1
 Light colour White
 Required components:

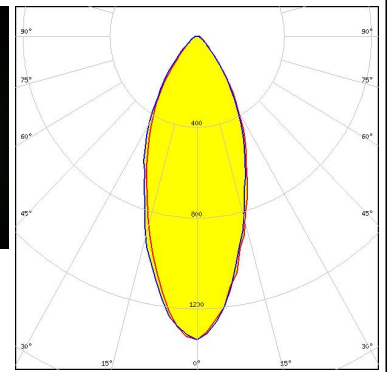
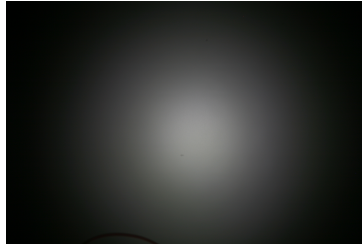

OPTICAL RESULTS (SIMULATED):

OSRAM
Opto Semiconductors

LED	OSLON SSL 120
FWHM / FWTM	61.0° / 83.0°
Efficiency	87 %
Peak intensity	1 cd/lm
LEDs/each optic	1
Light colour	Amber
Required components:	

