

STRADA-FT

Forward throw beam for area lighting. Assembly with installation tape.

TECHNICAL SPECIFICATIONS:

Dimensions	19.6 x 15.5 mm
Height	8.3 mm
Fastening	tape, pin, screw
ROHS compliant	yes ⓘ

MATERIAL SPECIFICATIONS:

Component	Type	Material	Colour	Finish
STRADA-FT	Single lens	PMMA	clear	
VOSU-WU-M-365-TAPE	Tape			

ORDERING INFORMATION:

Component		Qty in box	MOQ	MPQ	Box weight (kg)
CA13477_STRADA-FT	Single lens	3600	240	240	5.5
» Box size: 451 x 254 x 197 mm					



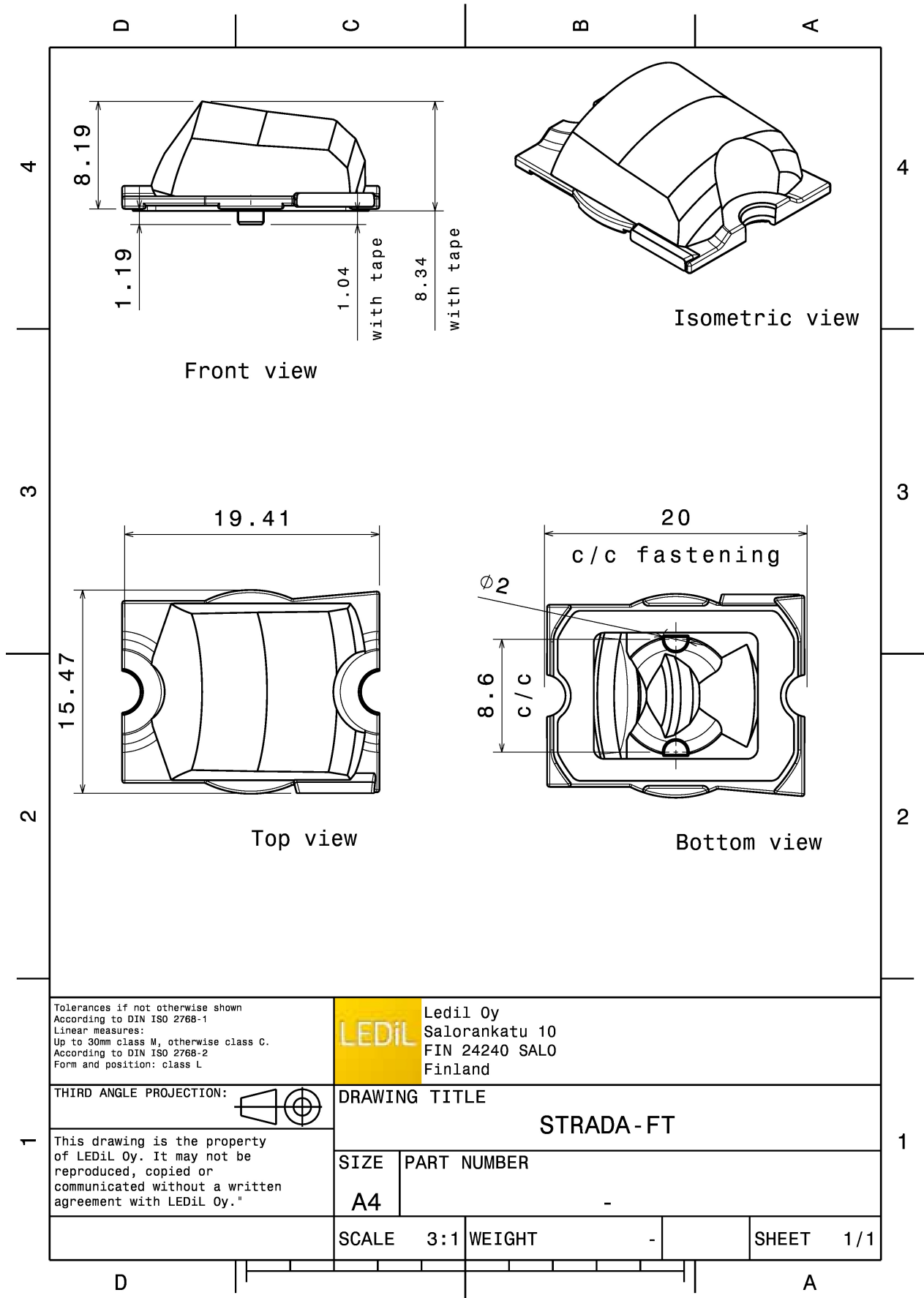

See also our general installation guide: www.ledil.com/installation_guide

PHOTOMETRIC DATA (MEASURED):

CREE LED

LED XT-E
FWHM / FWTM Asymmetric
Efficiency 87 %
Peak intensity 0.5 cd/lm
LEDs/each optic 1
Light colour White
Required components:

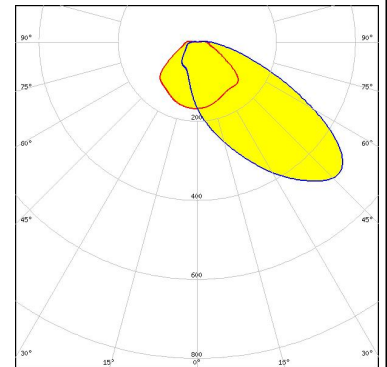

NICHIA

LED NVSW319B
FWHM / FWTM Asymmetric
Efficiency 86 %
Peak intensity 0.5 cd/lm
LEDs/each optic 1
Light colour White
Required components:

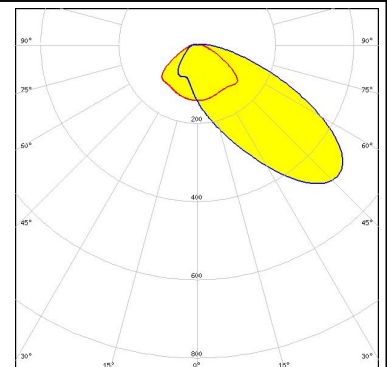

PHILIPS

LED Fortimo FastFlex 2x8 DS G3
FWHM / FWTM Asymmetric
Efficiency 86 %
Peak intensity 0.5 cd/lm
LEDs/each optic 1
Light colour White
Required components:

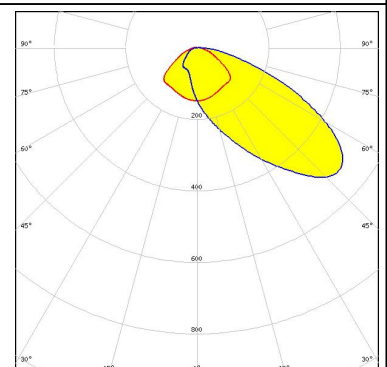

SAMSUNG

LED LH351Z
FWHM / FWTM Asymmetric
Efficiency 87 %
Peak intensity 0.5 cd/lm
LEDs/each optic 1
Light colour White
Required components:

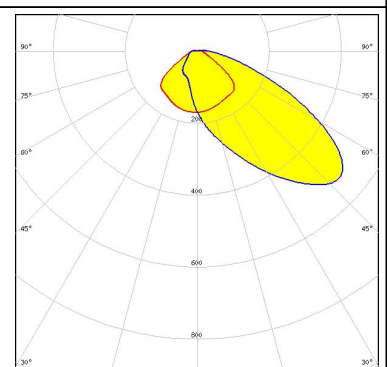

PHOTOMETRIC DATA (SIMULATED):



LED XP-G2
 FWHM / FWTM Asymmetric
 Efficiency 92 %
 Peak intensity 0.7 cd/lm
 LEDs/each optic 1
 Light colour White
 Required components:

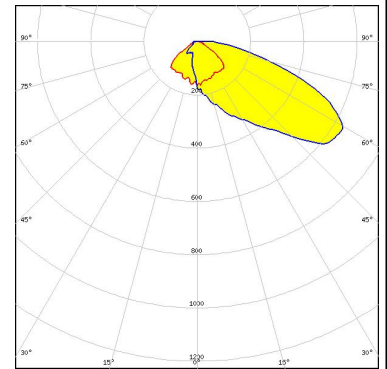

LED XP-G3
 FWHM / FWTM Asymmetric
 Efficiency 74 %
 Peak intensity 0.5 cd/lm
 LEDs/each optic 1
 Light colour White
 Required components:

Protective plate, glass

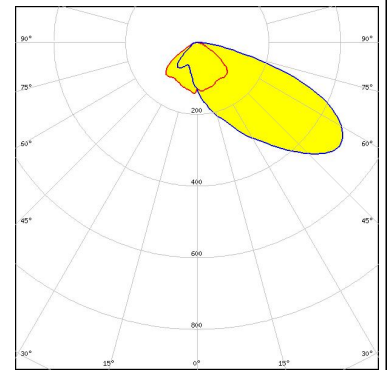

LED XP-G3
 FWHM / FWTM Asymmetric
 Efficiency 90 %
 Peak intensity 0.6 cd/lm
 LEDs/each optic 1
 Light colour White
 Required components:

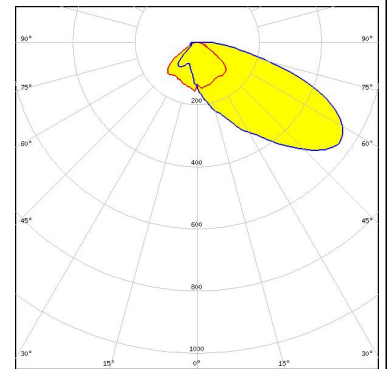

LED XP-G3
 FWHM / FWTM Asymmetric
 Efficiency 92 %
 Peak intensity 0.6 cd/lm
 LEDs/each optic 1
 Light colour White
 Required components:

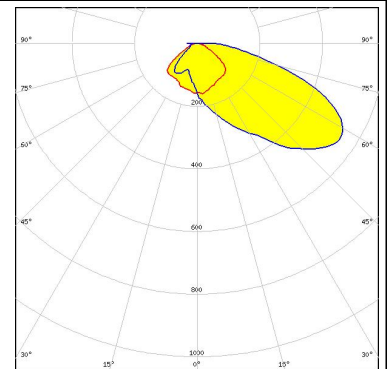

PHOTOMETRIC DATA (SIMULATED):

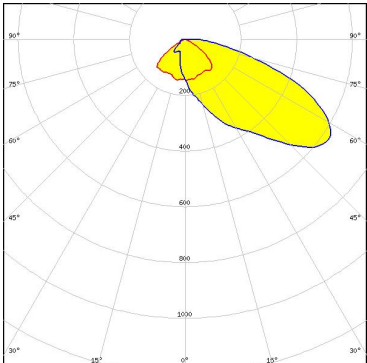
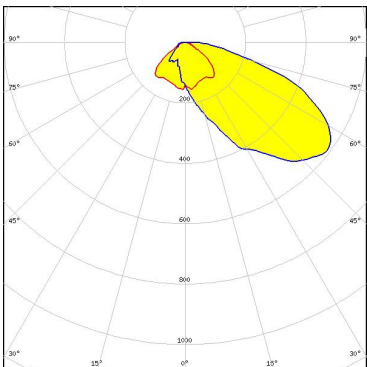
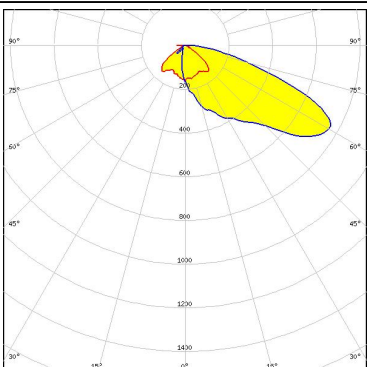
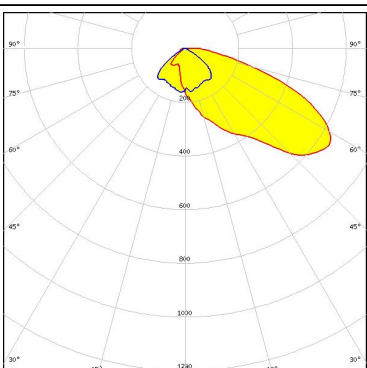
<p>NICHIA</p> <p>LED: NVSxx19B/NVSxx19C FWHM / FWTM: Asymmetric Efficiency: 92 % Peak intensity: 0.7 cd/lm LEDs/each optic: 1 Light colour: White Required components:</p>	
<p>OSRAM Opto Semiconductors</p> <p>LED: OSCONIQ P 3737 (3W version) FWHM / FWTM: Asymmetric Efficiency: 93 % Peak intensity: 0.6 cd/lm LEDs/each optic: 1 Light colour: White Required components:</p>	
<p>OSRAM Opto Semiconductors</p> <p>LED: OSOLON Square PC FWHM / FWTM: Asymmetric Efficiency: 93 % Peak intensity: 0.8 cd/lm LEDs/each optic: 1 Light colour: White Required components:</p>	
<p>SAMSUNG</p> <p>LED: LH351B FWHM / FWTM: Asymmetric Efficiency: 92 % Peak intensity: 0.7 cd/lm LEDs/each optic: 1 Light colour: White Required components:</p>	

PHOTOMETRIC DATA (SIMULATED):

SAMSUNG

LED	LM302Z plus
FWHM / FWTM	Asymmetric
Efficiency	94 %
Peak intensity	0.7 cd/lm
LEDs/each optic	1
Light colour	White
Required components:	

