

FLARE-MAXI-TAPE

34 x 33 mm lens with ~100° x 15° oval beam.
Assembly with installation tape.

SPECIFICATION:

Dimensions	33.9 x 33.3 mm
Height	16.9 mm
Fastening	tape, pin
ROHS compliant	yes ⓘ



MATERIALS:

Component	Type	Material	Colour	Finish
FLARE-MAXI	Single lens	PMMA	clear	
FLARE-MAXI-TAPE	Tape	Acrylic foam	clear	

ORDERING INFORMATION:

Component		Qty in box	MOQ	MPQ	Box weight (kg)
CA14366_FLARE-MAXI-TAPE	Single lens	864	144	72	9.7
» Box size:					

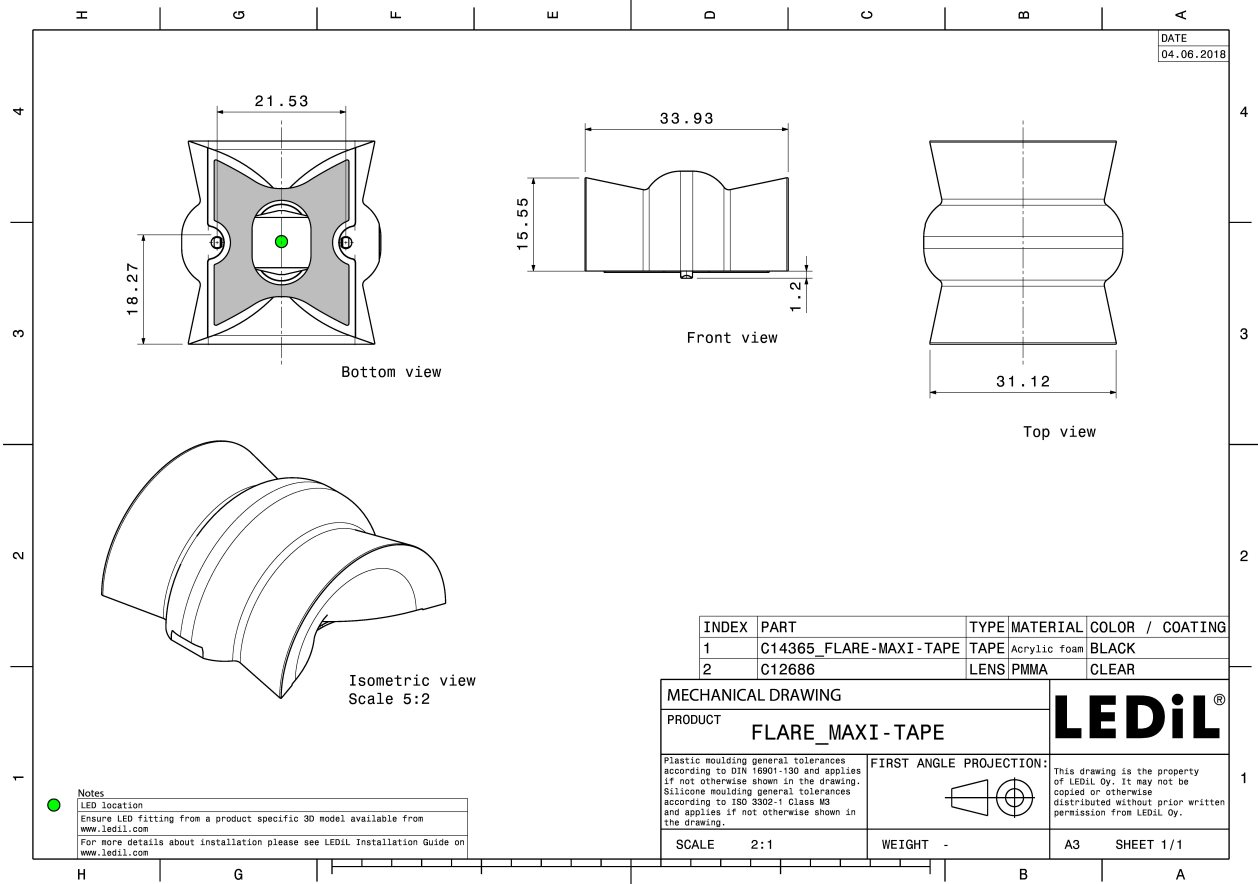

See also our general installation guide: www.ledil.com/installation_guide

OPTICAL RESULTS (MEASURED):



LED XD16
 FWHM / FWTM 100.0 + 8.0° / 140.0 + 14.0°
 Efficiency 90 %
 Peak intensity 3.2 cd/lm
 LEDs/each optic 1
 Light colour White
 Required components:

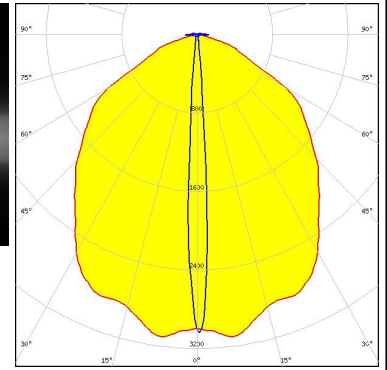
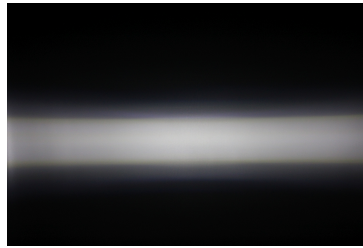

LED XM-L
 FWHM / FWTM 96.0 + 15.0° / 175.0°
 Efficiency 94 %
 Peak intensity 2.1 cd/lm
 LEDs/each optic 1
 Light colour White
 Required components:



LED XM-L2
 FWHM / FWTM 105.0 + 13.0°
 Efficiency 96 %
 LEDs/each optic 1
 Light colour White
 Required components:



LED XP-G
 FWHM / FWTM 105.0 + 11.0° / 174.0°
 Efficiency 94 %
 Peak intensity 2.5 cd/lm
 LEDs/each optic 1
 Light colour White
 Required components:

OPTICAL RESULTS (MEASURED):



LED XP-G2
 FWHM / FWTM 96.0 + 10.0° / 162.0°
 Efficiency 94 %
 Peak intensity 3.1 cd/lm
 LEDs/each optic 1
 Light colour White
 Required components:



LED XP-L HD
 FWHM / FWTM 115.0 + 13.0° / 149.0 + 19.0°
 Efficiency 94 %
 Peak intensity 2.1 cd/lm
 LEDs/each optic 1
 Light colour White
 Required components:

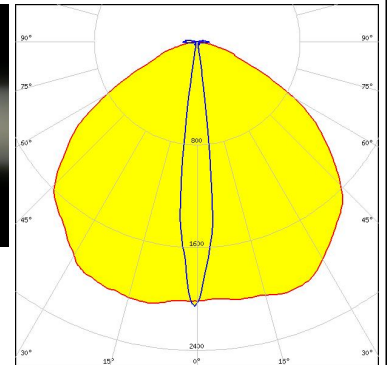
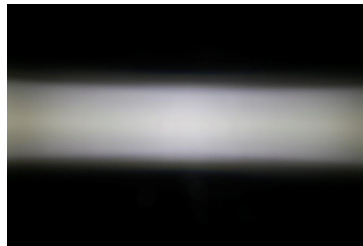

LED XP-L2
 FWHM / FWTM 99.0 + 13.0° / 158.0 + 21.0°
 Efficiency 94 %
 Peak intensity 2 cd/lm
 LEDs/each optic 1
 Light colour White
 Required components:

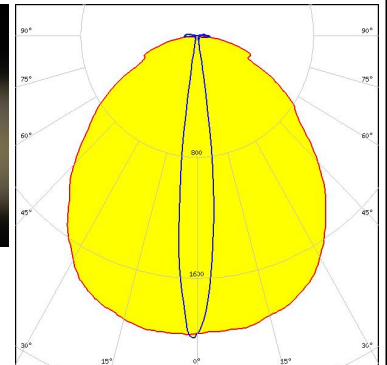
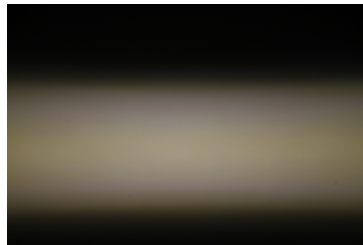

LED XT-E
 FWHM / FWTM 96.0 + 10.0° / 183.0°
 Efficiency 94 %
 Peak intensity 2.5 cd/lm
 LEDs/each optic 1
 Light colour White
 Required components:

OPTICAL RESULTS (MEASURED):

LUMILEDS

LED LUXEON Rebel ES
FWHM / FWTM 91.0 + 10.0° / 164.0°
Efficiency 94 %
Peak intensity 2.8 cd/lm
LEDs/each optic 1
Light colour White
Required components:

LUMILEDS

LED LUXEON T
FWHM / FWTM 96.0 + 10.0° / 262.0°
Efficiency 92 %
Peak intensity 2.9 cd/lm
LEDs/each optic 1
Light colour White
Required components:

LUMILEDS

LED LUXEON TX
FWHM / FWTM 96.0 + 9.0° / 141.0°
Efficiency 94 %
Peak intensity 3.2 cd/lm
LEDs/each optic 1
Light colour White
Required components:

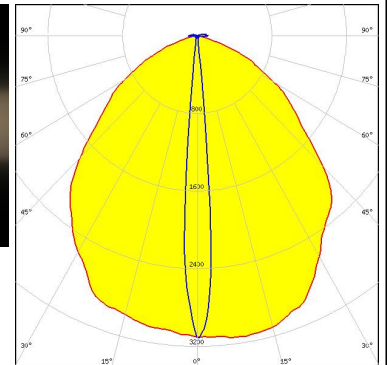
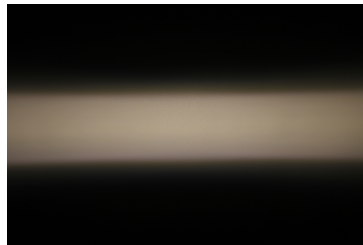

NICHIA

LED NCSxx19B
FWHM / FWTM 98.0 + 9.0° / 170.0°
Efficiency 94 %
Peak intensity 3.5 cd/lm
LEDs/each optic 1
Light colour White
Required components:

OPTICAL RESULTS (MEASURED):



LED NVSxx19B/NVSxx19C
 FWHM / FWTM 98.0 + 11.0° / 176.0°
 Efficiency 94 %
 Peak intensity 2.4 cd/lm
 LEDs/each optic 1
 Light colour White
 Required components:



LED OSLOM Square PC
 FWHM / FWTM 98.0 + 13.0° / 178.0°
 Efficiency 94 %
 Peak intensity 2.5 cd/lm
 LEDs/each optic 1
 Light colour White
 Required components:



LED LH351Z
 FWHM / FWTM 94.0 + 8.8° / 125.0 + 13.0°
 Efficiency 94 %
 Peak intensity 3.6 cd/lm
 LEDs/each optic 1
 Light colour White
 Required components:

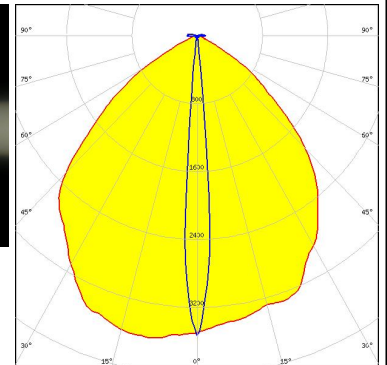
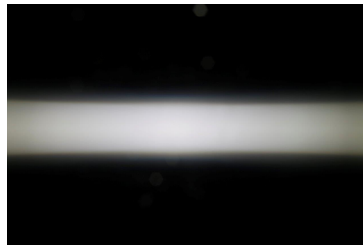

LED WICOP 5050
 FWHM / FWTM 112.0 + 17.0° / 158.0 + 27.0°
 Efficiency 93 %
 Peak intensity 1.4 cd/lm
 LEDs/each optic 1
 Light colour White
 Required components:

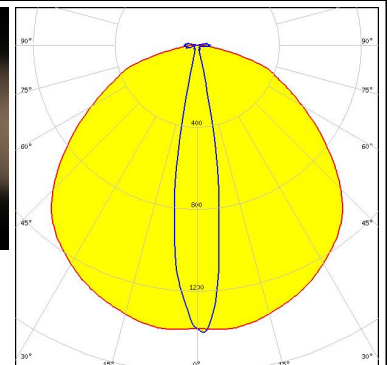
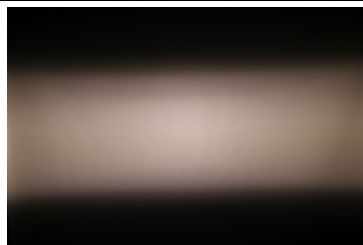

OPTICAL RESULTS (MEASURED):

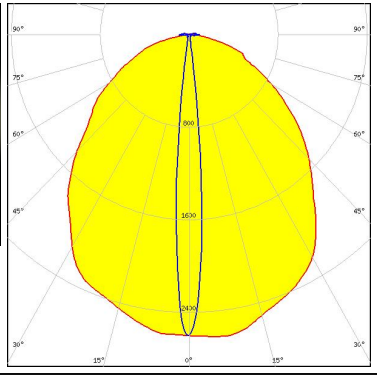
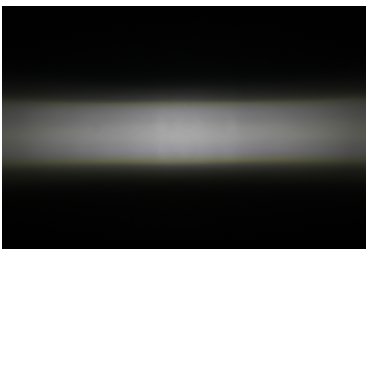
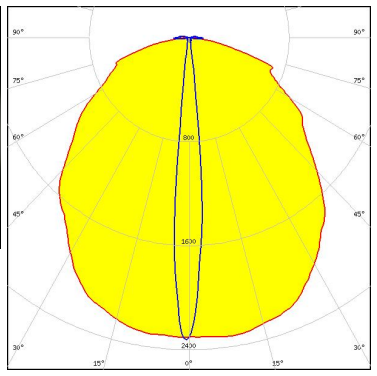
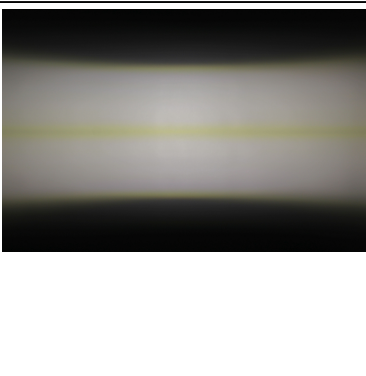
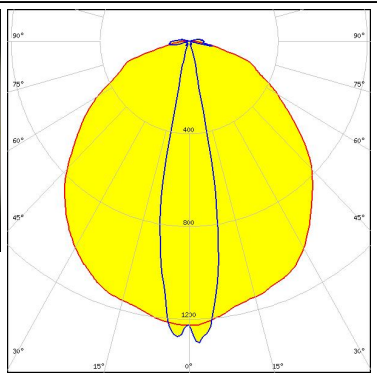
<p>SEOUL SEMICONDUCTOR</p> <p>LED Z5M3</p> <p>FWHM / FWTM 97.0 + 10.0° / 154.0 + 17.0°</p> <p>Efficiency 94 %</p> <p>Peak intensity 2.6 cd/lm</p> <p>LEDs/each optic 1</p> <p>Light colour White</p> <p>Required components:</p>		
<p>SEOUL SEMICONDUCTOR</p> <p>LED Z8Y22P</p> <p>FWHM / FWTM 104.0 + 10.0° / 160.0 + 17.0°</p> <p>Efficiency 93 %</p> <p>Peak intensity 2.3 cd/lm</p> <p>LEDs/each optic 1</p> <p>Light colour White</p> <p>Required components:</p>		
<p>SEOUL SEMICONDUCTOR</p> <p>LED Z8Y50P</p> <p>FWHM / FWTM 105.0 + 21.0° / 155.0 + 29.0°</p> <p>Efficiency 93 %</p> <p>Peak intensity 1.3 cd/lm</p> <p>LEDs/each optic 1</p> <p>Light colour White</p> <p>Required components:</p>		

OPTICAL RESULTS (SIMULATED):



LED XHP35 HD
 FWHM / FWTM 89.0 + 14.0° / 139.0 + 20.0°
 Efficiency 91 %
 Peak intensity 2.2 cd/lm
 LEDs/each optic 1
 Light colour White
 Required components:

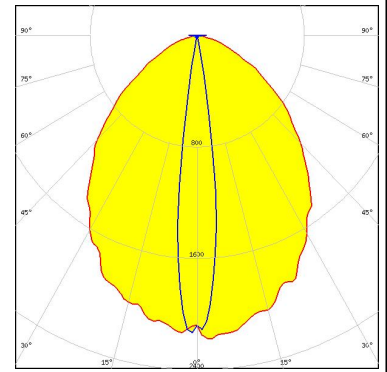

LED XHP35 HI
 FWHM / FWTM 82.0 + 10.0° / 136.0 + 15.0°
 Efficiency 93 %
 Peak intensity 3.2 cd/lm
 LEDs/each optic 1
 Light colour White
 Required components:

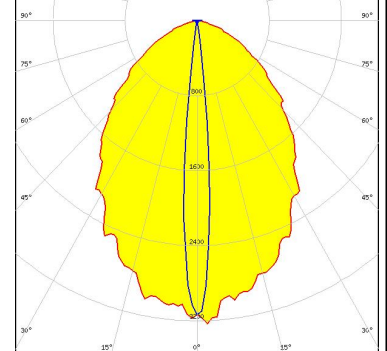

LED XP-E2
 FWHM / FWTM 6.0 + 41.0° / 13.0 + 109.0°
 Efficiency 94 %
 Peak intensity 5.6 cd/lm
 LEDs/each optic 1
 Light colour White
 Required components:

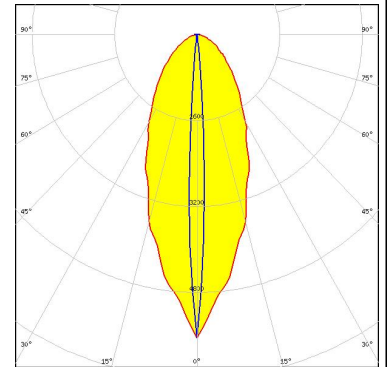

LED LUXEON CZ
 FWHM / FWTM 4.0 + 34.0° / 10.0 + 107.0°
 Efficiency 95 %
 Peak intensity 7.1 cd/lm
 LEDs/each optic 1
 Light colour Red
 Required components:

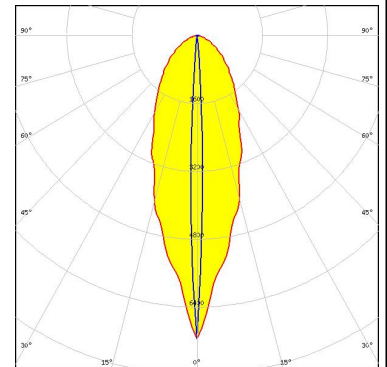

OPTICAL RESULTS (SIMULATED):

LUMILEDS

LED LUXEON H50-2
 FWHM / FWTM 9.5 + 64.0° / 137.0°
 Efficiency 92 %
 Peak intensity 3.6 cd/lm
 LEDs/each optic 1
 Light colour White
 Required components:

LUMILEDS

LED LUXEON Rubix
 FWHM / FWTM 41.0 + 4.0° / 118.0 + 10.0°
 Efficiency 96 %
 Peak intensity 6.7 cd/lm
 LEDs/each optic 1
 Light colour Blue
 Required components:

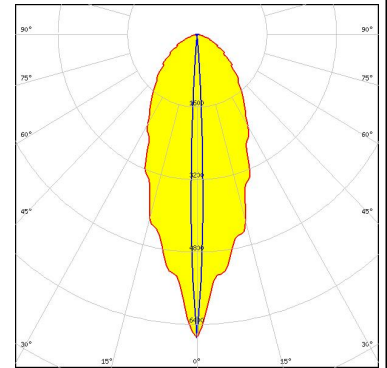

LUMILEDS

LED LUXEON Rubix
 FWHM / FWTM 41.0 + 4.0° / 118.0 + 10.0°
 Efficiency 96 %
 Peak intensity 6.6 cd/lm
 LEDs/each optic 1
 Light colour Green
 Required components:

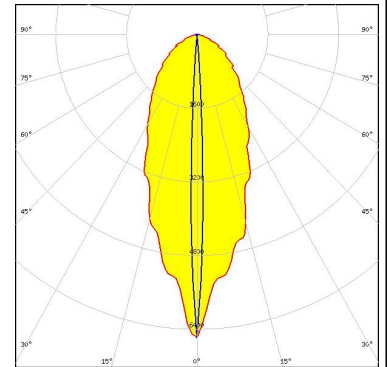

LUMILEDS

LED LUXEON Rubix
 FWHM / FWTM 39.0 + 4.0° / 114.0 + 10.0°
 Efficiency 96 %
 Peak intensity 7 cd/lm
 LEDs/each optic 1
 Light colour Red
 Required components:

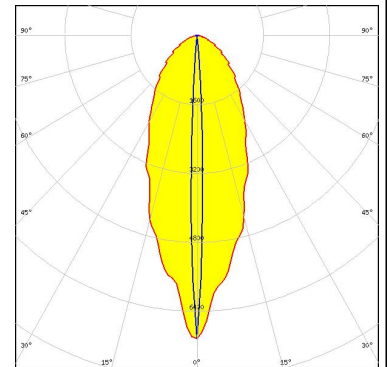

OPTICAL RESULTS (SIMULATED):

LUMILEDS

LED LUXEON Rubix
 FWHM / FWTM 40.0 + 4.0° / 117.0 + 10.0°
 Efficiency 96 %
 Peak intensity 6.7 cd/lm
 LEDs/each optic 1
 Light colour White
 Required components:

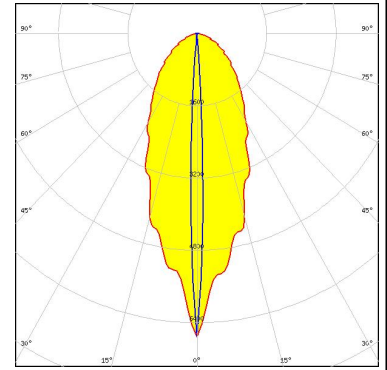

LUMINUS

LED SFT-40-WCS
 FWHM / FWTM 61.0 + 8.0° / 129.0 + 14.0°
 Efficiency 96 %
 Peak intensity 4.1 cd/lm
 LEDs/each optic 1
 Light colour White
 Required components:

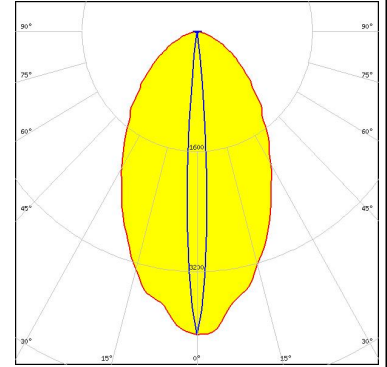

LUMINUS

LED SFT-70X-WCS
 FWHM / FWTM 72.0 + 10.0° / 132.0 + 16.0°
 Efficiency 96 %
 Peak intensity 3.1 cd/lm
 LEDs/each optic 1
 Light colour White
 Required components:

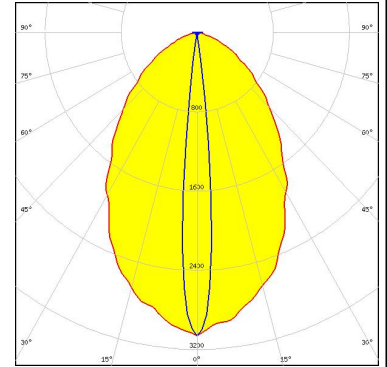

LUMINUS

LED SST-IRD-B90
 FWHM / FWTM 55.0 + 8.0° / 104.0 + 12.0°
 Efficiency 95 %
 LEDs/each optic 1
 Light colour IR
 Required components:

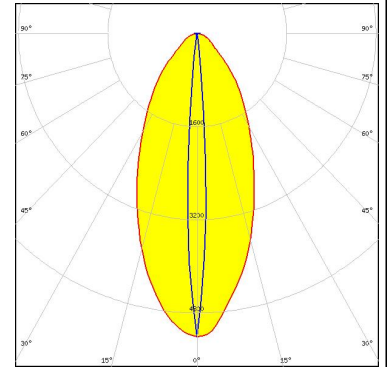
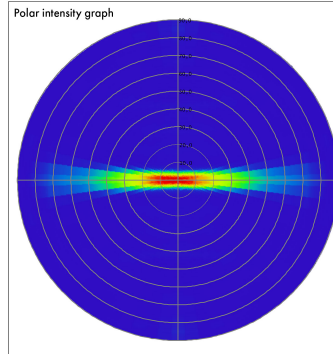

OPTICAL RESULTS (SIMULATED):

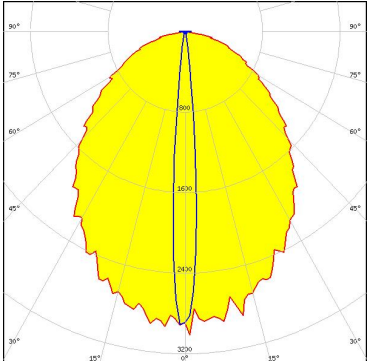
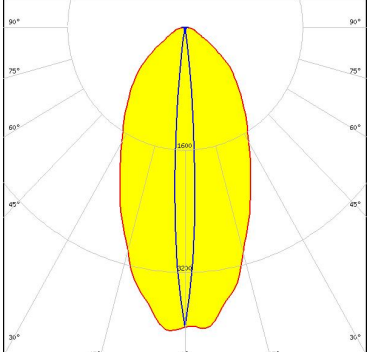
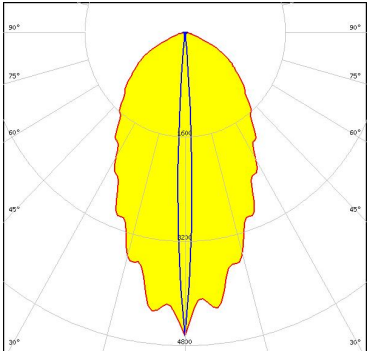
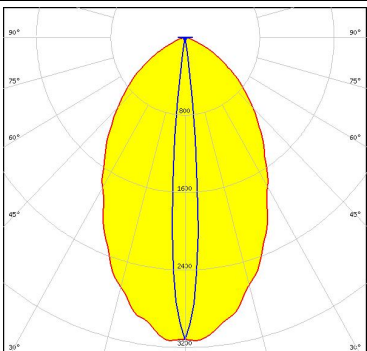
<p>NICHIA</p> <p>LED: NCSxE17A FWHM / FWTM: 90.0 + 9.0° / 150.0 + 18.0° Efficiency: 94 % Peak intensity: 3.1 cd/lm LEDs/each optic: 1 Light colour: White Required components:</p>	
<p>OSRAM Opto Semiconductors</p> <p>LED: OSLON Square EC FWHM / FWTM: 8.0 + 53.0° / 116.0 + 15.0° Efficiency: 94 % Peak intensity: 4 cd/lm LEDs/each optic: 1 Light colour: White Required components:</p>	
<p>OSRAM Opto Semiconductors</p> <p>LED: OSLON SSL 150 FWHM / FWTM: 6.0 + 58.0° / 12.0 + 131.0° Efficiency: 94 % Peak intensity: 4.7 cd/lm LEDs/each optic: 1 Light colour: Red Required components:</p>	
<p>SAMSUNG</p> <p>LED: LH351B FWHM / FWTM: 67.0 + 10.0° / 126.0 + 17.0° Efficiency: 94 % Peak intensity: 3.1 cd/lm LEDs/each optic: 1 Light colour: White Required components:</p>	

OPTICAL RESULTS (SIMULATED):

SAMSUNG

LED LH351C
 FWHM / FWTM 71.0 + 11.0° / 126.0 + 18.0°
 Efficiency 94 %
 Peak intensity 3 cd/lm
 LEDs/each optic 1
 Light colour White
 Required components:

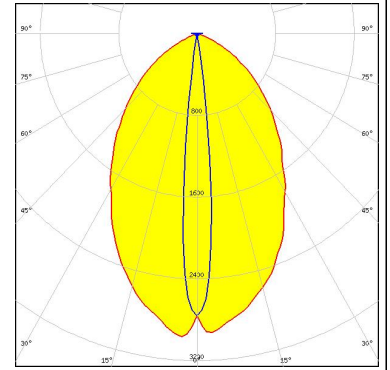

LED Z5M1/Z5M2
 FWHM / FWTM 67.0 + 8.0° / 127.0 + 14.0°
 Efficiency 94 %
 Peak intensity 3.6 cd/lm
 LEDs/each optic 1
 Light colour White
 Required components:

