

# Proximity Sensors Capacitive Thermoplastic Polyester Housing Types CA18CAN/CAF.....

CARLO GAVAZZI

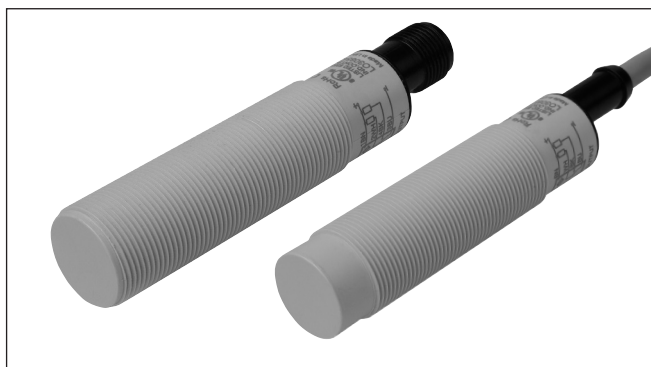

- 4<sup>TH</sup> Generation **TRIPLESHIELD™**
- Adjustable sensing distance: 2 - 10 mm Flush or 3-15 mm Non-flush
- Protection: short-circuit, transients and reverse polarity
- Dust and humidity compensation
- Dust or Temperature alarm output
- Rated operational voltage: 10-40 VDC
- Output: DC 200 mA, NPN or PNP
- Standard Output: NO and NC
- LED indications for Power-supply, Target and Stability
- IP67, IP68, IP69K, Nema 1, 2, 4, 4X, 5, 6, 6P, 12
- Cable and M12 connector versions available



## Product Description

The CA18CA.. capacitive proximity switches feature an improved 4<sup>TH</sup> Generation **TRIPLESHIELD™** technology. Furthermore, these sensors feature increased immunity to electromagnetic interference (EMI), especially to frequency drives. Not only does 4<sup>TH</sup> Generation **TRIPLESHIELD™** feature an increased EMI, but it also increases the immunity to humidity and dust. The implementation of stability indication eases the setup procedure as both Stable ON and Stable OFF positions are

indicated by the green and yellow LEDs.

The sensing distance is increased by 25 % allowing room for additional stable detection.

The Dust Alarm function gives an early warning that the sensing surroundings have to be cleaned.

The Temperature alarm function raises an alarm if the sensing surface goes beyond 60 degree Celcius.

The sensor housing is featuring IP69K as well as approval by ECOLAB for cleaning- and disinfection agents.

## Ordering Key

**CA18CAN12NAM1**

Capacitive proximity switch	CA18CAN12NAM1
Housing diameter (mm)	CA18CAN12NAM1
Housing material	CA18CAN12NAM1
Housing length	CA18CAN12NAM1
Detection principle	CA18CAN12NAM1
Rated operating dist. (mm)	CA18CAN12NAM1
Output type	CA18CAN12NAM1
Output configuration	CA18CAN12NAM1
Connection type	CA18CAN12NAM1

## Type Selection

Housing diameter	Sensor type	Output type	Output function	Connection	Rated operating distance (S <sub>n</sub> )	Ordering no. Standard	Ordering no. Dust alarm	Ordering no. Temperature alarm
M 18	Flush	NPN	NO+NC	Cable	0 - 8 mm	<b>CA18CAF08NA</b>		
M 18	Flush	NPN	NO+NC	M12 Plug	0 - 8 mm	<b>CA18CAF08NAM1</b>		
M 18	Flush	PNP	NO+NC	Cable	0 - 8 mm	<b>CA18CAF08PA</b>		
M 18	Flush	PNP	NO+NC	M12 Plug	0 - 8 mm	<b>CA18CAF08PAM1</b>		
M 18	Flush	PNP	NO	Cable	0 - 8 mm		CA18CAF08PODU <sup>1)</sup>	CA18CAF08POTA <sup>1)</sup>
M 18	Flush	PNP	NC	Cable	0 - 8 mm		CA18CAF08PCDU <sup>1)</sup>	CA18CAF08PCTA <sup>1)</sup>
M 18	Non-Flush	NPN	NO+NC	Cable	0 - 12 mm	<b>CA18CAN12NA</b>		
M 18	Non-Flush	NPN	NO+NC	M12 Plug	0 - 12 mm	<b>CA18CAN12NAM1</b>		
M 18	Non-Flush	PNP	NO+NC	Cable	0 - 12 mm	<b>CA18CAN12PA</b>		
M 18	Non-Flush	PNP	NO+NC	M12 Plug	0 - 12 mm	<b>CA18CAN12PAM1</b>		
M 18	Non-Flush	PNP	NO	Cable	0 - 12 mm		CA18CAN12PODU <sup>2)</sup>	CA18CAN12POTA <sup>2)</sup>
M 18	Non-Flush	PNP	NC	Cable	0 - 12 mm		CA18CAN12PCDU <sup>2)</sup>	CA18CAN12PCTA <sup>2)</sup>

<sup>1)</sup> Replaced by CA18CAF08BPA2IO

<sup>2)</sup> Replaced by CA18CAN12BPA2IO

## Specifications EN 60947-5-2

**Rated operating distance (S<sub>n</sub>)**  
Non-flush mounted sensor

0 - 12 mm (factory setting 12 mm),  
(ref. target 36x36 mm ST37,  
1 mm thick, grounded)

Flush mounted sensor

0 - 8 mm (factory setting  
8 mm - non-flush mounted)  
(ref. target 24x24 mm ST37,  
1 mm thick, grounded)

**Specifications (cont.)** EN 60947-5-2

<b>Sensitivity control</b>	Adjustable by potentiometer	<b>Connection</b>	
Electrical adjustment	11 turns	Cable	PVC, Ø5.2 x 2 m, 4 x 0.34 mm <sup>2</sup>
Mechanical adjustment	16 turns		Oil proof, grey
Adjustable distance		Plug (M1)	M12 x 1 - 4 pin
Flush types	2 to 10 mm	<b>Temperature alarm output</b>	60°C ± 5°C
Non-flush types	3 to 15 mm	Response time examples	
		$T_A = 25^\circ\text{C}$	14 sec @ $T_{\text{EXC}} = 80^\circ\text{C}$ 315 sec @ $T_{\text{EXC}} = 80^\circ\text{C}$
<b>Effective operating dist. (<math>S_r</math>)</b>	$0.9 \times S_n \leq S_r \leq 1.1 \times S_n$	<b>TRIPLESHIELD™</b>	
<b>Usable operating dist. (<math>S_u</math>)*</b>	$0.85 \times S_r \leq S_u \leq 1.15 \times S_r$	<b>Exceeding the norms for capacitive sensors</b>	
<b>Repeat accuracy (R)</b>	≤ 5%	Electrostatic discharge (EN61000-4-2)	
<b>Hysteresis (H)</b>	3 - 20%	Contact discharge	> 40 kV
<b>Rated operational volt. (<math>U_B</math>)</b>	10 to 40 VDC (ripple incl.)	Air discharge	> 40 kV
<b>Ripple</b>	≤ 10%	Electrical fast transients/burst (EN 61000-4-4)	±4kV
<b>Output function</b>	NPN or PNP	Surge (EN 61000-4-5)	
<b>Output switching function</b>	N.O. and N.C.	Power-supply	> 2kV (with 500 Ω)
<b>Rated operational current (<math>I_a</math>)</b>	≤ 200 mA (continuous)	Sensor output	> 2kV (with 500 Ω)
<b>Capacitive load</b>	100 nF	Wire conducted disturbances (EN 61000-4-6)	> 20 Vrms
<b>No-load supply current (<math>I_o</math>)</b>	≤ 12 mA	Power-frequency magnetic fields (EN 61000-4-8)	
<b>Voltage drop (<math>U_d</math>)</b>	≤ 2.0 VDC @ 200 mA DC	Continuous	> 60 A/m, 75.9 μ tesla
<b>Minimum operational current (<math>I_m</math>)</b>	≥ 0.5 mA	Short-time	> 600 A/m, 759 μ tesla
<b>OFF state current (<math>I_r</math>)</b>	≤ 100 μA	Radiated RF electromagnetic fields (EN 61000-4-3)	> 20 V/m
<b>Protection</b>	Short-circuit, reverse polarity, transients	Shock (IEC 60068-2-27)	30 G / 11ms, 3 pos, 3 neg per axis
<b>Frequency of operating cycles (f)</b>	50 Hz	Rough handling shocks (IEC 60068-2-31)	2 times from 1m 100 times from 0,5m
<b>Response time OFF-ON (<math>t_{on}</math>)</b>	≤ 10 ms	Vibration (IEC 60068-2-6)	10 to 150 Hz, 1 mm / 15 G
<b>Response time ON-OFF (<math>t_{off}</math>)</b>	≤ 10 ms	<b>Housing material</b>	
<b>Power ON delay (<math>t_v</math>)</b>	≤ 200 ms	Body	PBT, grey, 30% glass reinforced
<b>Indication</b>		Cable gland	PA12, black
Target detected	LED, yellow	Fingernuts	PA12, black
Power and detection stability	LED, green	Trimmershaft	Nylon
<b>Environment</b>		<b>Weight</b>	
Installation category	III (IEC 60664, 60664A; 60947-1)	Cable version	150 g
Degree of pollution	3 (IEC 60664, 60664A; 60947-1)	Plug version	75 g
Degree of protection	IP 67, IP 68/60 min., IP69K** (IEC 60529; 60943-1)	<b>Approvals</b>	cULus (UL508), ECOLAB
NEMA type	1, 2, 4, 4X, 5, 6, 6P, 12	<b>CE-marking</b>	Yes
Operating temperature	-30 to +85°C (-22 to +185°F)	<b>MTTF<sub>d</sub></b>	825 years @ 40°C (+104°F)
Max. temperature on sensing face	120°C (248°F)		
Storage temperature	-40 to +85°C (-40 to +185°F)		
<b>Rated insulation voltage</b>	1 kVAC (rms) IEC protection class III 		
<b>Tightening torque</b>	≤ 2.6 Nm		

\* For Flush type sensor flush mounted in conductive material, the usable operating distance ( $S_u$ ) is  $0.80 \times S_r \leq S_u \leq 1.2 \times S_r$ , for temperatures exceeding 0 - 60 °C (32 - 140°F).

\*\* The IP69K test according to DIN 40050-9 for high-pressure, high-temperature wash-down applications. The sensor must not only be dust tight (IP6X), but also able to withstand high-pressure and steam cleaning. The sensor is exposed to high pressure water from a spray nozzle that is fed with 80°C water at 8'000-10'000 KPa (80-100bar) and a flow rate of 14-6L/min. The nozzle is held 100 -150 mm from the sensor at angles of 0°, 30°, 60° and 90° for 30s each. The test device sits on a turntable that rotates with a speed of 5 times per minute. The sensor must not suffer any damaging effects from the high pressure water in appearance and function.

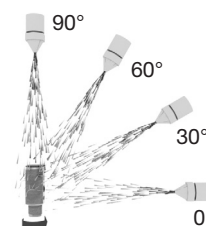

## Adjustment Guide

The environments in which capacitive sensors are installed can often be unstable as regards temperature, humidity, object distance and industrial (noise) interference. That is why Carlo Gavazzi offers as standard features in

all TRIPLESIELD™ capacitive sensors a user-friendly sensitivity adjustment instead of a fixed sensing range. Likewise, these sensors provide an extended sensing range to accommodate mechanically demanding areas and tem-

perature stability to ensure high immunity to electromagnetic interference (EMI) and a minimum need for adjusting sensitivity, if the temperature varies.

**Note:**  
The sensors are factory set (default) to nominal sensing range Sn.Sn.

## Wiring Diagram

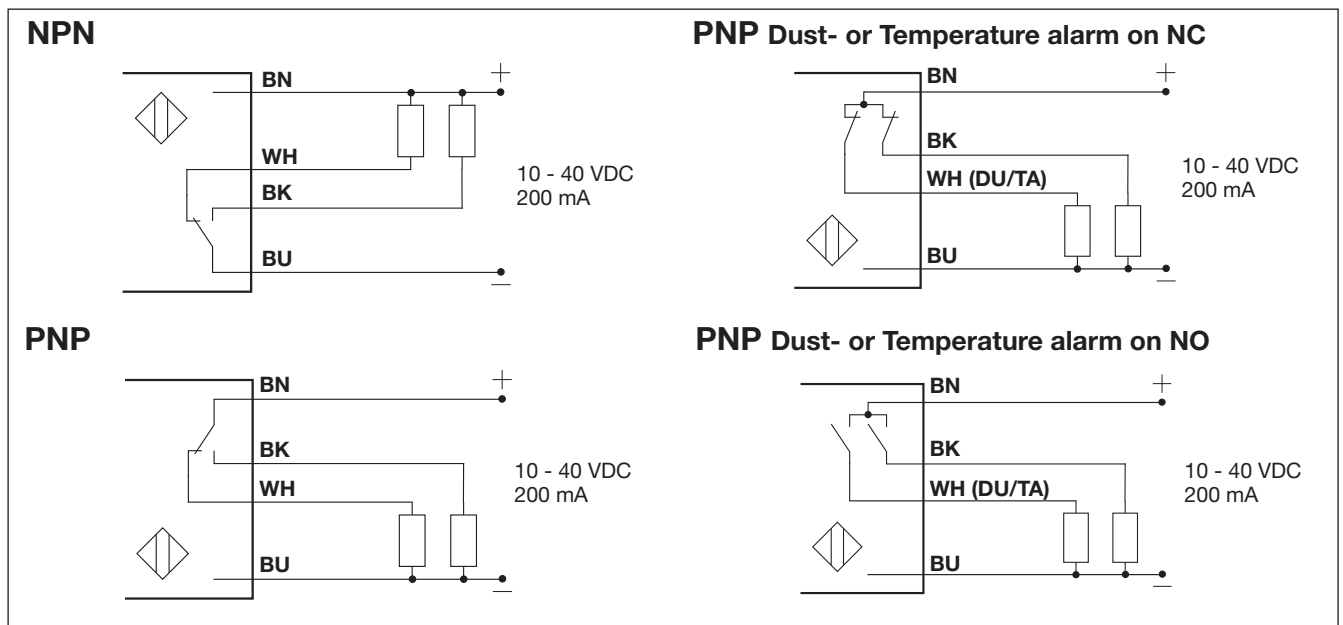

## Detection Diagram

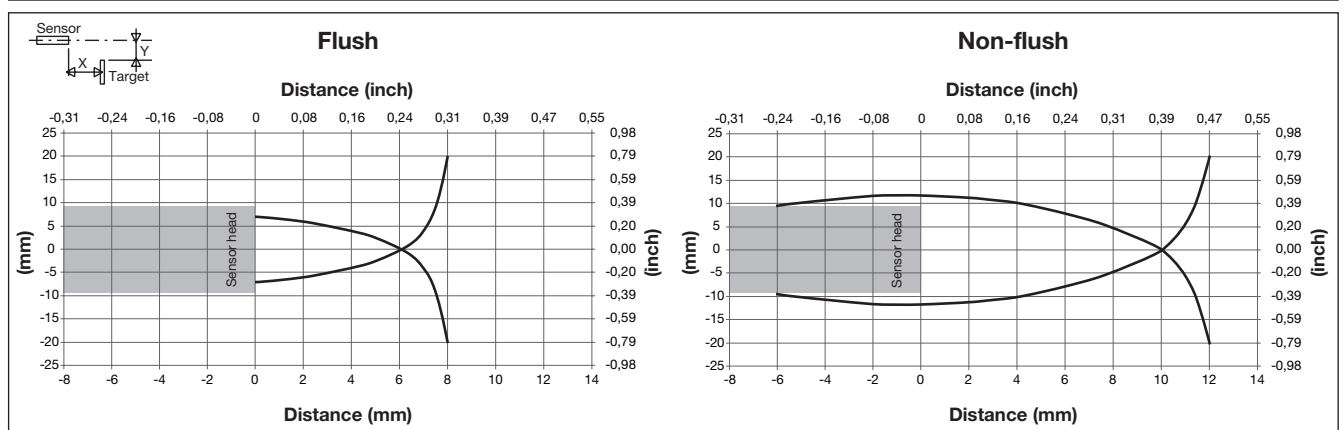

## Detection Stability Indication

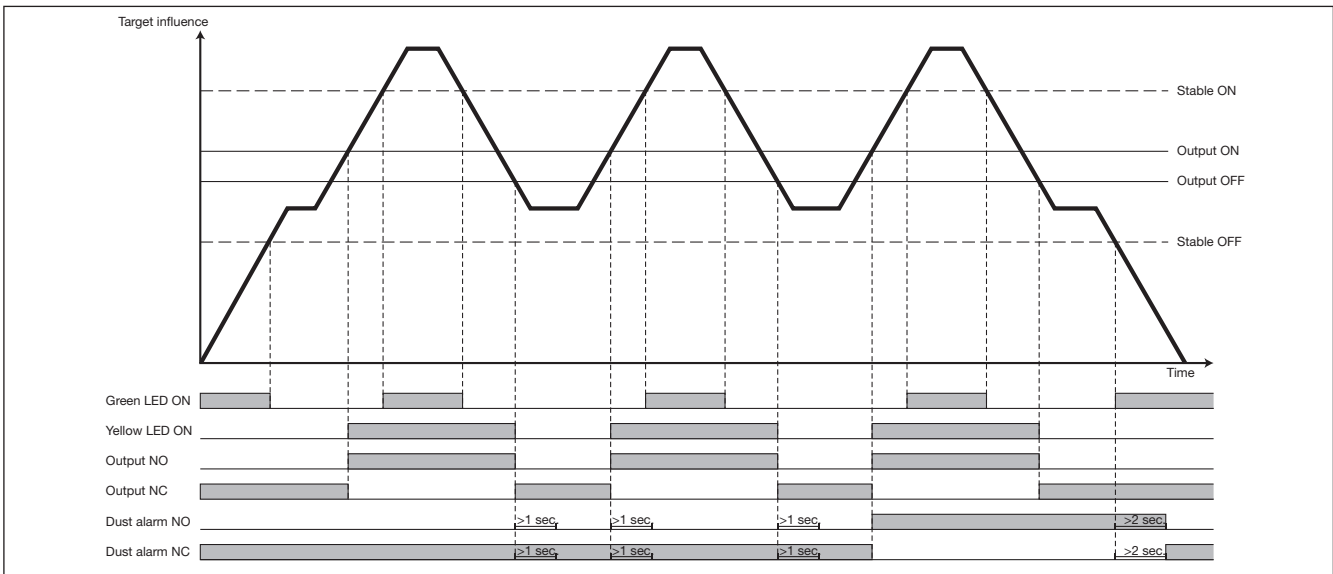

## Dimensions

CA18CAF....

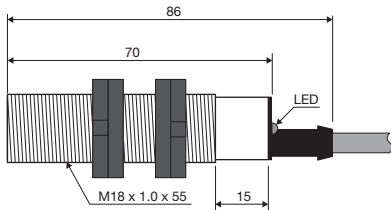

CA18CAF....M1

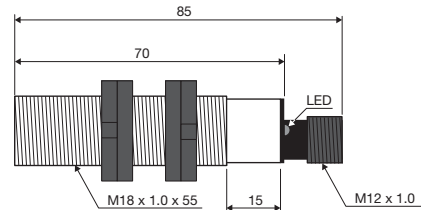

CA18CAN....

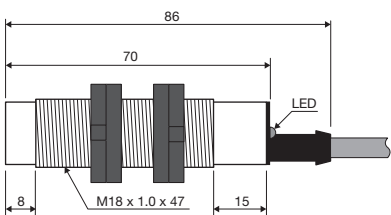

CA18CAN....M1

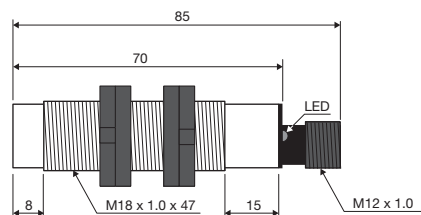

### Cable

### The back of the sensor

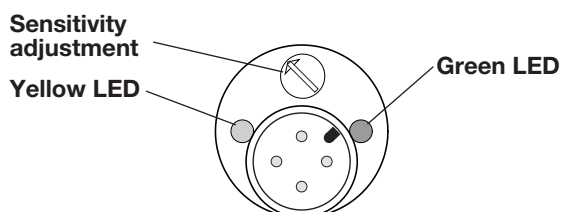

### Plug

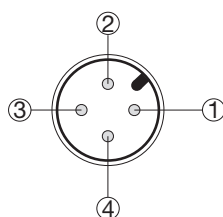

### Colour code

- 1 Brown
- 2 White
- 3 Blue
- 4 Black