

CA18FAxxBPxIO - IO-Link

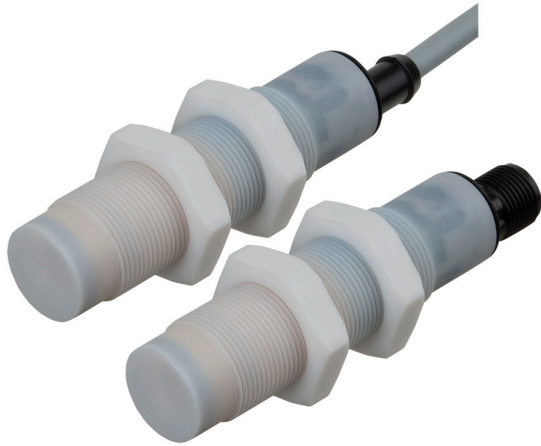

Capacitive Proximity Sensors with IO-Link communication



Description

The new generation of CA18FA...IO sensors are a complete family of high performance capacitive sensors for detection of most solid or liquid targets in industrial applications such as Plastic & Rubber, Agriculture, Food & Beverage and Materials handling. The 4th Generation of TRIPLESIELD™ technology provides increased immunity to electromagnetic interference (EMI), especially to frequency drives, and improves immunity to humidity and dust.

The sensor housing has the IP69K rating as well as approval by ECOLAB for cleaning and disinfection agents.

On-board IO-Link communication opens up a variety of functions, such as easy communication and customization of advanced parameter settings.

Benefits

- **A complete family.** Available in M18 in a robust PTFE housing with an operation of 2-10 mm flush or 3-15 mm non-flush.
- **Enhanced EMC performance:** 4th Generation TRIPLESIELD™
- **Easy customization to specific OEM requests:** different cable lengths and materials, special labelling: customized pig-tail solutions with special cables and connectors are possible on request..
- **The output** can be operated either as a switching output or in IO-Link mode.
- **Fully configurable via output IO-Link v 1.1.** Electrical outputs can be configured as PNP / NPN / Push-Pull / External input, normally open or normally closed.
- **Timer functions** can be set, such as ON-delay, Off-delay, and one shots.
- **Logging functions:** Temperatures, detecting counter, power cycles and operating hours.
- **Detection modes** Single point, two point and windows mode.
- **Analogue output:** In IO-Link mode the sensor will generate 16 bit analogue process data output representing the dielectric value measured by the sensor.



IO-Link

Applications

- Detection not only of the level of plastic pellets in plastic moulding machines but also the dielectric value of the pellets to ensure correct manufacturing.
- Detection not only of the wood pellets in pellet burners but also the density of the wood pellets.



Main functions

- The sensor can be operated in IO-Link mode once connected to an IO-Link master or in standard I/O mode.
- Adjustable parameters via IO-Link interface:
 - ▶ Sensing distance and hysteresis.
 - ▶ Sensing modes: single point or two point or window mode.
 - ▶ Timer functions, e.g.: On-delay, Off delay, One shot leading edge or trailing edge.
 - ▶ Logic functions such as: AND, OR, X-OR and SR-FF.
 - ▶ External input.
 - ▶ Logging functions: Maximum temperatures, minimum temperatures, operating hours, operating cycles, power cycles, minutes above maximum temperature, minutes below minimum temperature, etc.

References

Product selection key

 CA18FA BP IO

 Enter the code option instead of

Code	Option	Description
C	-	Sensing principle: Capacitive sensor
A	-	Cylindrical housing with threaded barrel
18	-	Housing diameter (mm)
F	-	PTFE housing
A	-	Axial sensing
<input type="checkbox"/>	F	Flush installation
	N	Non-flush installation
<input type="checkbox"/>	08	Sensing distance: 8 mm
	12	Sensing distance: 12 mm
B	-	Selectable functions: NPN, PNP, Push-Pull, External Input (only pin 2) or External teach input (only pin 2)
P	-	Selectable: N.O. or N.C.
<input type="checkbox"/>	A2	2 metre PVC cable
	M1	M12, 4-pole connector
IO	-	IO-Link version

Additional characters can be used for customized versions.

Type selection

Connection	Distance	Mounting	Code
Cable	8 mm	Flush	CA18FAF08BPA2IO
	12 mm	Non-flush	CA18FAN12BPA2IO
Plug	8 mm	Flush	CA18FAF08BPM1IO
	12 mm	Non-flush	CA18FAN12BPM1IO

Structure

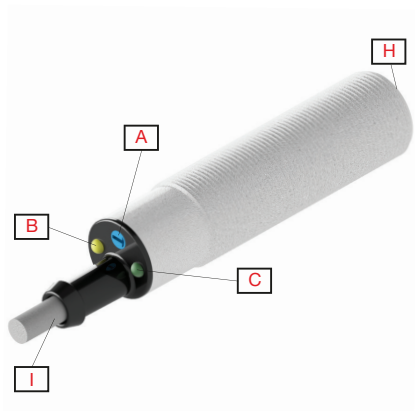

Fig. 1 CA18 Cable

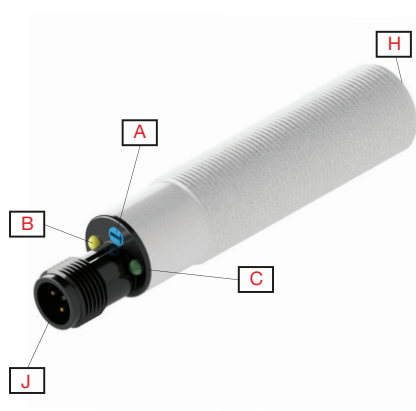

Fig. 2 CA18 Plug

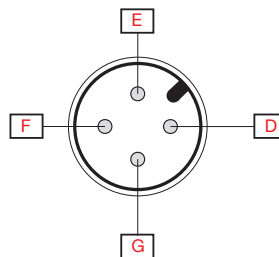
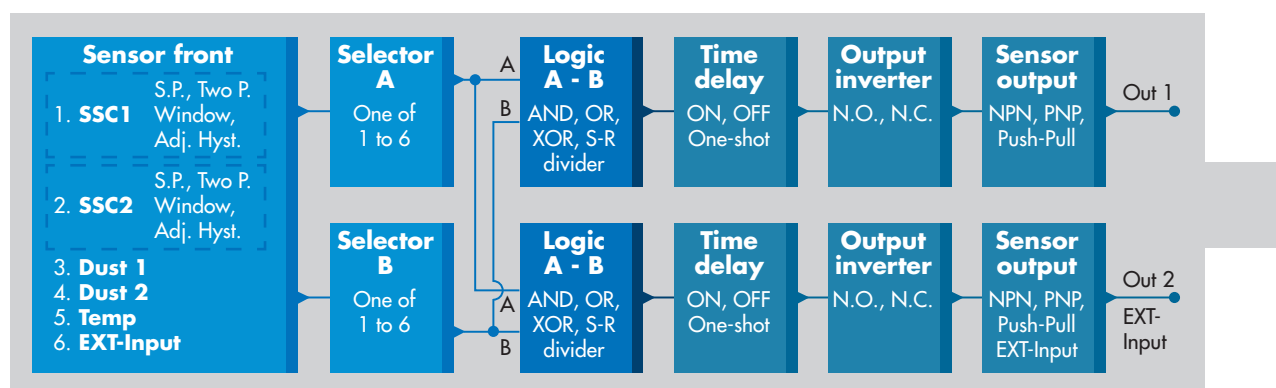

Fig. 3 Colour code

A	Sensitivity adjustment	F	Blue
B	Yellow LED	G	Black
C	Green LED	H	Sensing face
D	Brown	I	2 m, 4 wire PVC Ø 5,2 mm cable
E	White	J	M12x1, 4-pin male connector

Sensing

Detection



Sensor switching channel SSC1 and SSC2	SSC1 <ul style="list-style-type: none"> • Enabled • Disabled Factory settings: Enabled	SSC2 <ul style="list-style-type: none"> • Enabled • Disabled Factory settings: Enabled
Switching mode	SSC1 <ul style="list-style-type: none"> • Deactivated • Single point mode • Two point mode • Windows mode Factory settings: Single point mode	SSC2 <ul style="list-style-type: none"> • Deactivated • Single point mode • Two point mode • Windows mode Factory settings: Single point mode
Rated operating distance (S_n)	0 - 12 mm (Factory settings: 12 mm), (ref. target 36x36 mm ST37, 1 mm thick, grounded)	Non-flush-mounted sensor
	0 - 8 mm (Factory settings: 8 mm), (ref. target 24x24 mm ST37, 1 mm thick, grounded)	Flush-mounted sensor
Sensitivity control	Adjustable by potentiometer, external teach or by IO-Link settings <ul style="list-style-type: none"> • Potentiometer disabled • Potentiometer enabled • External teach Factory settings: Potentiometer enabled	
Potentiometer	Electrical adjustment	11 turns
	Mechanical adjustment	16 turns
Adjustable distance	2 ... 10 mm (flush types) Factory settings: SP1 1000 and SP2 10000	
	3 ... 15 mm (Non- flush types) Factory settings: SP1 1000 and SP2 10000	
Effective operating distance (S_r)	$0.9 \times S_n \leq S_r \leq 1.1 \times S_n$	
Usable operating dist. (S_u)*	$0.85 \times S_r \leq S_u \leq 1.15 \times S_r$	
Hysteresis (H) CA18FAF08... CA18FAN12...	Adjustable by IO-Link (1% to 100%) Factory settings: Typical 4% Factory settings: Typical 15%	
Detection filter	This function can increase the immunity towards unstable targets and electromagnetic disturbances: Value can be set from 1 to 255. Factory settings: 1 (1 is max. operating frequency and 255 is min. operating frequency)	



* For Flush-mounted sensors in conductive material, the usable operating distance (S_u) is $0.80 \times S_r \leq S_u \leq 1.2 \times S_r$ for temperatures exceeding $0^\circ\text{C} - 60^\circ\text{C}$ ($32^\circ\text{F} - 140^\circ\text{F}$).

Alarm settings

Dust alarm SSC1 and SSC2	SSC1 • 0 to 100 % of actual SP Factory settings: 2 times standard hysteresis	SSC2 • 0 to 100 % of actual SP Factory settings: 2 times standard hysteresis
Temperature alarm	• High threshold -50 to +150 °C • Low threshold -50 to +150 °C Factory settings: <i>High value 120 °C (front temperature sensor used)</i> <i>Low value -30 °C (front temperature sensor used)</i>	



Detection diagram

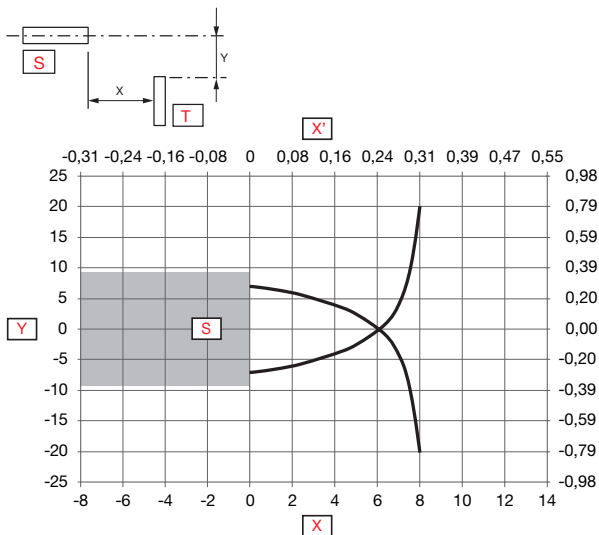

Fig. 4 Flush

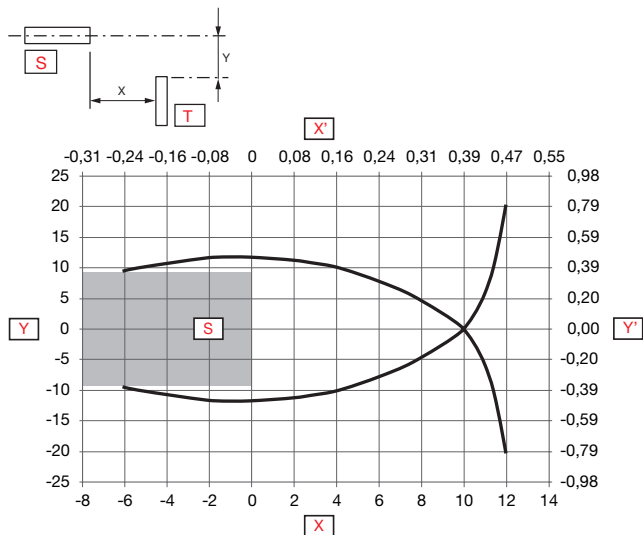

Fig. 5 Non-flush

Y	Detection width [mm]	X'	Sensing range [inches]
X	Sensing range [mm]	S	Sensor
Y'	Detection width [inches]	T	Target

Accuracy

Repeat accuracy (R)	≤ 5%
---------------------	------

Operation diagram

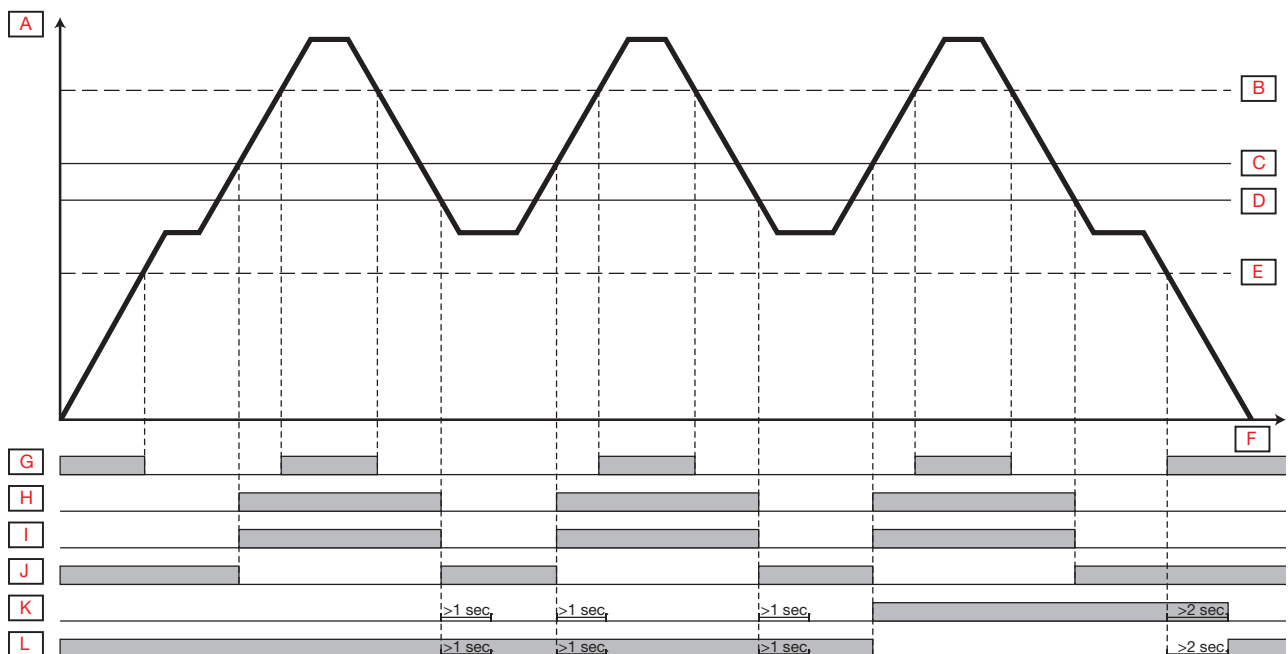



A	Target influence	G	Green LED ON
B	stable ON	H	Yellow LED ON
C	Output ON	I	Output N.O.
D	Output OFF	J	Output N.C.
E	stable OFF	K	Dust alarm N.O.
F	Time	L	Dust alarm N.C.

Features

Power Supply

Rated operational voltage (U_B)	10 ... 40 VDC (ripple included)
Ripple (U_{rpp})	$\leq 10\%$
No load supply current (I_o)	≤ 20 mA
Rated insulation voltage (U_i)	50 VDC
Power-ON delay (tv)	≤ 300 ms

Input selector

Input selector	Channel A <ul style="list-style-type: none"> • Deactivated • SSC1 • SSC2 • Dust alarm 1 • Dust alarm 2 • Temperature alarm • External input Factory settings: SSC1	Channel B <ul style="list-style-type: none"> • Deactivated • SSC1 • SSC2 • Dust alarm 1 • Dust alarm 2 • Temperature alarm • External input Factory settings: SSC1
----------------	---	---

Logic functions

Logic functions	Channel A + B for SO1 <ul style="list-style-type: none"> • Direct • AND • OR • X-OR • SR-FF Factory settings: Direct	Channel A + B for SO2 <ul style="list-style-type: none"> • Direct • AND • OR • X-OR • SR-FF Factory settings: Direct
-----------------	---	---

Time delays

Timer mode	For SO1 <ul style="list-style-type: none"> • Disabled • Power-ON delay • Power-OFF delay • Power-ON delay and Power-OFF delay • One-shot leading edge • One-shot trailing edge Factory settings: Disabled	For SO2 <ul style="list-style-type: none"> • Disabled • Power-ON delay • Power-OFF delay • Power-ON delay and Power-OFF delay • One-shot leading edge • One-shot trailing edge Factory settings: Disabled
Timer scale	For SO1 <ul style="list-style-type: none"> • [ms] • [s] • [min] Factory settings: ms	For SO2 <ul style="list-style-type: none"> • [ms] • [s] • [min] Factory settings: ms
Timer value	For SO1 <ul style="list-style-type: none"> • 0 ... 32 767 Factory settings: 0	For SO2 <ul style="list-style-type: none"> • 0 ... 32 767 Factory settings: 0

Output Inverter

Output Inverter	For SO1 Pin 4 Black wire: <ul style="list-style-type: none"> • N.O. • N.C. Factory settings: N.O.	For SO2 Pin 2 White wire: <ul style="list-style-type: none"> • N.O. • N.C. Factory settings: N.C.
------------------------	---	---

Sensor Output

Switching Output Stage SO1 and SO2	For SO1 Pin 4 Black wire: <ul style="list-style-type: none"> • NPN • PNP • Push-Pull Factory settings: PNP	For SO2 Pin 2 White wire: <ul style="list-style-type: none"> • NPN • PNP • Push-Pull • External input, active high • External input, active low • External teach Factory settings: PNP
---	---	--

Outputs

Rated operational current (I_o) (I_e)	≤ 200 mA (Continuous, SO1 + SO2)	
OFF-state current (I_o)	≤ 100 μA	
Minimum operational current (I_m)	> 0,5 mA	
Voltage drop (U_d)	≤ 1.0 VDC @ 200 mA DC	
Protection	Short circuit, reverse polarity, transients	
Utilization category	DC-12	Control of resistive loads and solid-state loads with optical isolation
	DC-13	Control of electromagnets
Load capacitance max at (U_o)	100 nF	



Operation diagram

For default factory sensor

Tv = Power-ON delay



Response times

Operating frequency (f)	50 Hz.	
Response times	t _{ON} (OFF-ON)	< 10 ms
	t _{OFF} (ON-OFF)	< 10 ms

Indication

Green LED	Yellow LED	Power	Function
SIO and IO-Link mode			
ON	ON	ON	ON (stable)* SSC1
ON	OFF	ON	OFF (stable)* SSC1
OFF	ON	-	ON (Not stable) SSC1
OFF	OFF	-	OFF (Not stable) SSC1
-	Flashing 10 Hz 50% dutycycle	ON	Output short-circuit
-	Flashing (0.5...20 Hz)	ON	Timer indication
SIO mode only			
-	Flashing 1 HZ ON 100 ms OFF 900 ms	ON	External teach by wire. Only for single point mode
-	Flashing 1 HZ ON 900 ms OFF 100 ms	ON	Teach time window (3 - 6 sec)
-	Flashing 10 HZ ON 50 ms OFF 50 ms Flashing for 2 sec	ON	Teach time out (12 sec)
-	Flashing 2 HZ ON 250 ms OFF 250 ms Flashing for 2 sec	ON	Teach successful
IO-Link mode only			
Flashing 1 HZ Stable: ON 900 ms OFF 100 ms Not stable: ON 100 ms OFF 900 ms	-	ON	Sensor is in IO-Link mode
Flashing 2 Hz 50% dutycycle		ON	Find my sensor

*See operation diagram

LED indication

LED indications	<ul style="list-style-type: none"> • LED Indication disabled • LED Indication enabled • Find my sensor <p>Factory settings: LED Indication enabled</p>
------------------------	--

Environmental

Ambient temperature	-30°C... +85°C (-22°F... +185°F)	Operating
	-40°C ... +85°C (-40°F ... +185°F)	Storage
Max. temperature on sensing face	120°C (248°F)	
Ambient humidity range	35% ... 95%	Operating
	35% ... 95%	Storage
Vibration	10 ... 150 Hz, 1 mm / 15 G	EN 60068-2-6
Shock	30 G / 11 ms, 3 pos, 3 neg per axis	EN 60068-2-27
Drop test	2 x 1 m 100 x 0,5 m	EN 60068-2-31
Rated impulse withstand voltage	≥2 kV	with 500 Ω
Overvoltage category	III	IEC 60664, EN 60947-1
Pollution degree	3	IEC 60664, 60664A; EN 60947-1
IP rating	IP 67, IP 68/60 min.,	EN 60529; EN 60947-1
	IP69K*	DIN 40050-9
NEMA Enclosure Types	1, 2, 4, 4X, 5, 6, 6P, 12	NEMA 250
Tightening torque	≤ 1 Nm	

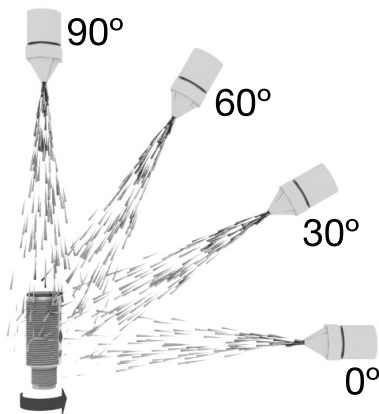

* The IP69K test according to DIN 40050-9 for high-pressure, high-temperature wash-down applications. The sensor must not only be dust tight (IP6X), but also able to withstand high-pressure and steam cleaning. The sensor is exposed to high pressure water from a spray nozzle that is fed with 80°C water at 8'000– 10'000 KPa (80–100bar) and a flow rate of 14–6L/min. The nozzle is held 100 –150 mm from the sensor at angles of 0°, 30°, 60° and 90° for 30s each. The test device sits on a turntable that rotates with a speed of 5 times per minute. The sensor must not suffer any damaging effects in appearance or function from the high pressure water function.

TRIPLESHIELD™

Exceeding the norms for capacitive sensors.

Electrostatic discharge immunity test	contact discharge	> 40 kV	IEC 61000-4-2; EN60947-1
	air discharge	> 40 kV	
Electromagnetic field immunity	20 V/m		IEC 61000-4-3; EN60947-1
Electrical fast transient immunity	±4kV / 5kHz		IEC 61000-4-4; EN60947-1
Wire-conducted noise	> 20 Vrms		IEC 61000-4-3; EN60947-1
Power frequency magnetic fields	Continuous	> 60 A/m, 75.9 μ tesla	IEC 61000-4-8; EN60947-1
	Short-time	> 600 A/m, 759 μ tesla	

Diagnostic parameters

Function	Unit	Range
Values stored in the sensor (Saved every hour)		
Operating Hours	[h]	0 ... 2 147 483 647
Number of Power Cycles	[cycles]	0 ... 2 147 483 647
Maximum temperature - All time high	[°C]	-50 ... +150
Minimum temperature - All time low	[°C]	-50 ... +150
Detection counter SSC1	[cycles]	0 ... 2 147 483 647
Minutes above Maximum Temperature	[min]	0 ... 2 147 483 647
Minutes below Minimum Temperature	[min]	0 ... 2 147 483 647
Values stored in the sensor (Saved with events)		
Maintenance event counter	[counts]	0 ... 2 147 483 647
Download counter	[counts]	0 ... 65 536
Values not saved in sensor		
Maximum temperature - Since last power-up	[°C]	-50 ... +150
Minimum temperature - Since last power-up	[°C]	-50 ... +150
Current temperature	[°C]	-50 ... +150

Events Configuration

Events	Factory default setting
Temperature fault event	Inactive
Temperature over-run	Inactive
Temperature under-run	Inactive
Short circuit	Inactive
Maintenance	Inactive

Process data configuration

Process Data	Factory default setting
Analogue value	Active
SO1, Switching output 1	Active
SO2, Switching output 2	Active
SSC1, Sensor switching channel 1	Inactive
SSC2, Sensor switching channel 2	Inactive
DA1, Dust Alarm for SSC1	Inactive
DA2, Dust alarm for SSC2	Inactive
TA, Temperature alarm	Inactive
SC, Short circuit	Inactive

Process data structure

4 Bytes, Analogue value 16 ... 31 (16 bit)

Byte 0	31	30	29	28	27	26	25	24
	MSB	-	-	-	-	-	-	-
Byte 1	23	22	21	20	19	18	17	16
	-	-	-	-	-	-	-	LSB
Byte 2	15	14	13	12	11	10	9	8
	-	-	SC	TA	DA2	DA1	SSC2	SSC1
Byte 3	7	6	5	4	3	2	1	0
	-	-	-	-	-	-	SO2	SO1

Mechanics/electronics

Connection

Cable	2 m, 4 wire, 4 x 0,34 mm ² , Ø5.2 mm Oil proof PVC, grey
Plug (M1)	M12 x 1, 4 pin male

Wiring

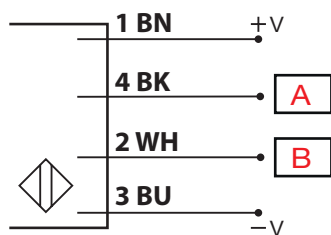

BN	BK	WH	BU	A	B
Brown	Black	White	Blue	OUT/IO-Link	IN/OUT

Housing

Body	PTFE	
Cable gland	Grilamid TR 55, Black	
Nuts	PTFE	
Trimmer shaft	Nylon, Blue	
Light guides	Grilamid TR 55, Transparent	
Dimensions	M18 x 1	Thread
Thread length	47 mm	Non-flush
	55 mm	Flush
Total length	70 mm	Housing
Weight	≤ 137 g	Cable version
	≤ 62 g	Plug version

Dimensions (mm)

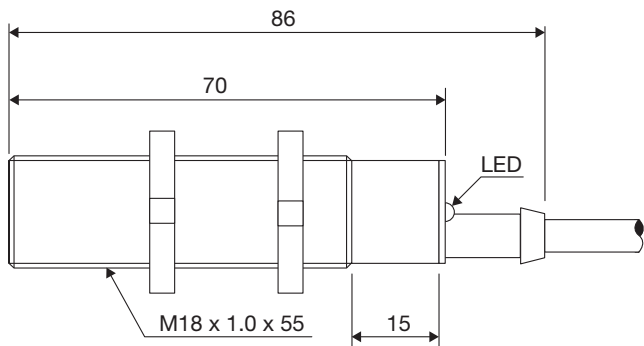

Fig. 6 Cable CA18EAF...A2IO

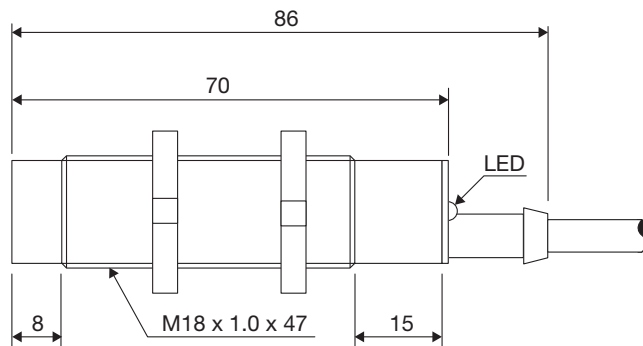

Fig. 7 Cable CA18EAN...A2IO

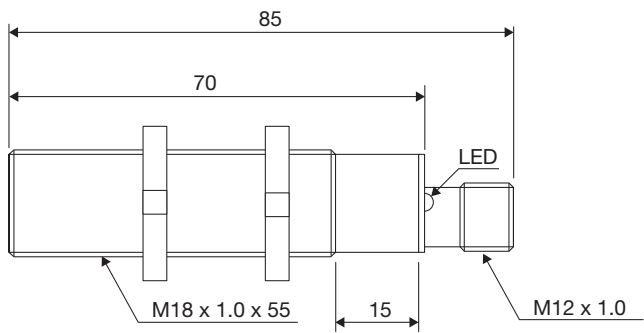

Fig. 8 Plug CA18EAF...M1IO

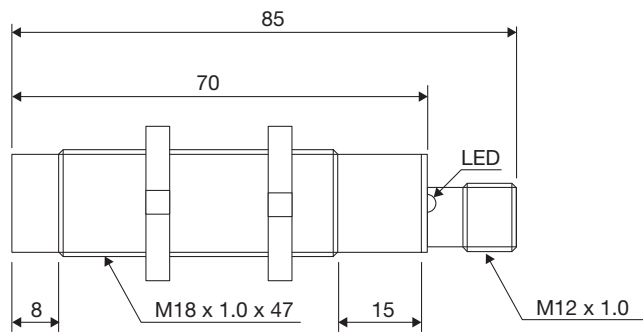





Fig. 9 Plug CA18EAN...M1IO

Compatibility and conformity

Approvals and markings

General reference	Sensor designed according to EN60947-5-2 and EN60947-1	
MTTF_d	114.6 years @ 40°C (+104°F)	ISO 13849-1, SN 29500
CE-marking		
Approvals		
Other Approvals		Topax 56, Topaz AC1, Topaz MD3, Topaz CL1, Topactiv OKTO, P3-hypochloran

IO-Link

IO-Link revision	1.1
Transmission rate	COM2 (38.4 kbaud)
SDCI-Norm	IEC 61131-9
Profile	Smart sensor profile 2nd edition, common profile
Min. cycle time	5 ms
SIO mode	Yes
Min. master port class	A (4-pin)
Process data length	32 bit