

# CA18FAxxBPxIO - IO-Link

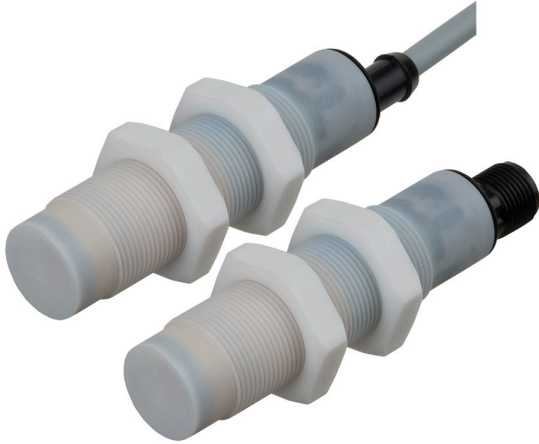

## Capacitive Proximity Sensors with IO-Link communication



### Description

The new generation of CA18FA...IO sensors are a complete family of high performance capacitive sensors for detection of most solid or liquid targets in industrial applications such as Plastic & Rubber, Agriculture, Food & Beverage and Materials handling. The 4<sup>th</sup> Generation of TRIPLESIELD™ technology provides increased immunity to electromagnetic interference (EMI), especially to frequency drives, and improves immunity to humidity and dust.

The sensor housing has the IP69K rating as well as approval by ECOLAB for cleaning and disinfection agents.

On-board IO-Link communication opens up a variety of functions, such as easy communication and customization of advanced parameter settings.

### Benefits

- **A complete family.** Available in M18 in a robust PTFE housing with an operation of 2-10 mm flush or 3-15 mm non-flush.
- **Enhanced EMC performance:** 4<sup>th</sup> Generation TRIPLESIELD™
- **Easy customization to specific OEM requests:** different cable lengths and materials, special labelling: customized pig-tail solutions with special cables and connectors are possible on request..
- **The output** can be operated either as a switching output or in IO-Link mode.
- **Fully configurable via output IO-Link v 1.1.** Electrical outputs can be configured as PNP / NPN / Push-Pull / External input, normally open or normally closed.
- **Timer functions** can be set, such as ON-delay, Off-delay, and one shots.
- **Logging functions:** Temperatures, detecting counter, power cycles and operating hours.
- **Detection modes** Single point, two point and windows mode.
- **Analogue output:** In IO-Link mode the sensor will generate 16 bit analogue process data output representing the dielectric value measured by the sensor.



## IO-Link

### Applications

- Detection not only of the level of plastic pellets in plastic moulding machines but also the dielectric value of the pellets to ensure correct manufacturing.
- Detection not only of the wood pellets in pellet burners but also the density of the wood pellets.



### Main functions

- The sensor can be operated in IO-Link mode once connected to an IO-Link master or in standard I/O mode.
- Adjustable parameters via IO-Link interface:
  - ▶ Sensing distance and hysteresis.
  - ▶ Sensing modes: single point or two point or window mode.
  - ▶ Timer functions, e.g.: On-delay, Off delay, One shot leading edge or trailing edge.
  - ▶ Logic functions such as: AND, OR, X-OR and SR-FF.
  - ▶ External input.
  - ▶ Logging functions: Maximum temperatures, minimum temperatures, operating hours, operating cycles, power cycles, minutes above maximum temperature, minutes below minimum temperature, etc.

## References

### Product selection key

 CA18FA   BP  IO

 Enter the code option instead of 

| Code                     | Option | Description  |
|--------------------------|--------|--|
| C                        | -      | Sensing principle: Capacitive sensor   |
| A                        | -      | Cylindrical housing with threaded barrel   |
| 18                       | -      | Housing diameter (mm)  |
| F                        | -      | PTFE housing   |
| A                        | -      | Axial sensing  |
| <input type="checkbox"/> | F      | Flush installation   |
|                          | N      | Non-flush installation   |
| <input type="checkbox"/> | 08     | Sensing distance: 8 mm   |
|                          | 12     | Sensing distance: 12 mm  |
| B                        | -      | <b>Selectable functions:</b> NPN, PNP, Push-Pull, External Input (only pin 2) or External teach input (only pin 2) |
| P                        | -      | <b>Selectable:</b> N.O. or N.C.  |
| <input type="checkbox"/> | A2     | 2 metre PVC cable  |
|                          | M1     | M12, 4-pole connector  |
| IO                       | -      | IO-Link version  |

Additional characters can be used for customized versions.

### Type selection

| Connection | Distance | Mounting  | Code            |
|------------|----------|-----------|-----------------|
| Cable      | 8 mm     | Flush     | CA18FAF08BPA2IO |
|            | 12 mm    | Non-flush | CA18FAN12BPA2IO |
| Plug       | 8 mm     | Flush     | CA18FAF08BPM1IO |
|            | 12 mm    | Non-flush | CA18FAN12BPM1IO |



# Structure

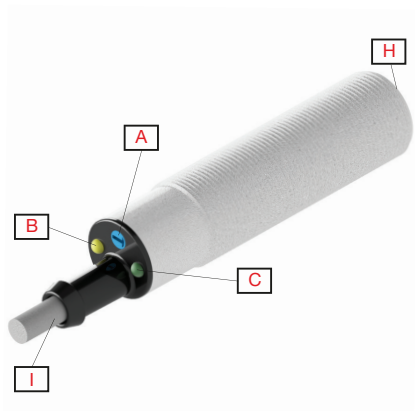

Fig. 1 CA18 Cable

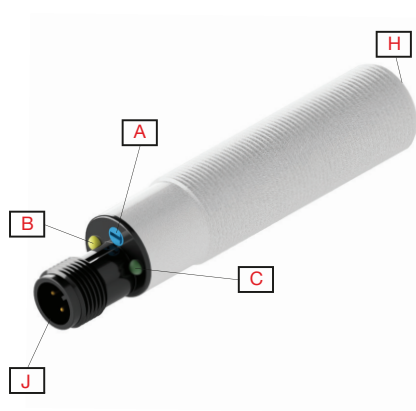

Fig. 2 CA18 Plug

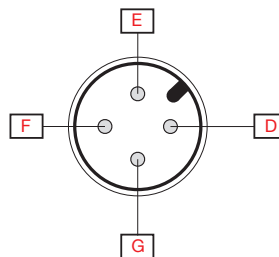
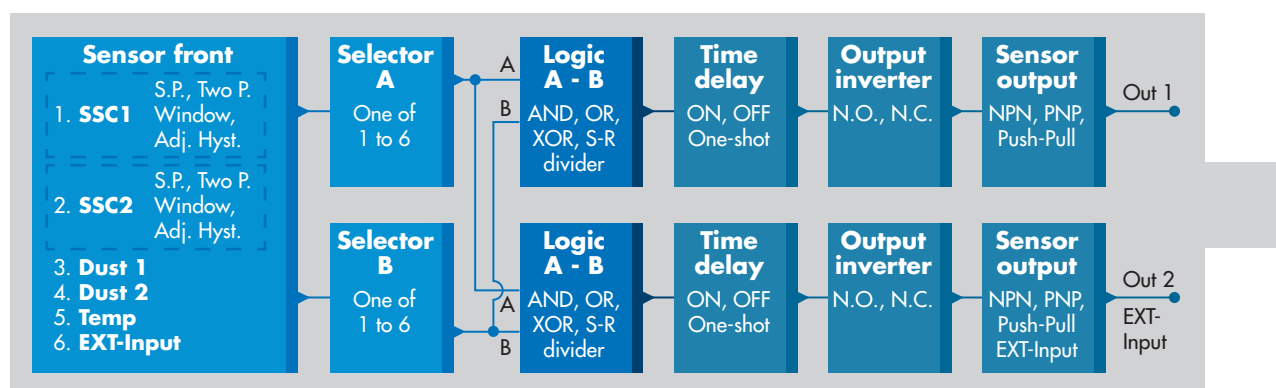

Fig. 3 Colour code

|          |                        |          |                                |
|----------|------------------------|----------|--------------------------------|
| <b>A</b> | Sensitivity adjustment | <b>F</b> | Blue                           |
| <b>B</b> | Yellow LED             | <b>G</b> | Black                          |
| <b>C</b> | Green LED              | <b>H</b> | Sensing face                   |
| <b>D</b> | Brown                  | <b>I</b> | 2 m, 4 wire PVC Ø 5,2 mm cable |
| <b>E</b> | White                  | <b>J</b> | M12x1, 4-pin male connector    |

# Sensing

## Detection



|   |   |   |
|---|---|---|
| <b>Sensor switching channel SSC1 and SSC2</b>         | <b>SSC1</b> <ul style="list-style-type: none"> <li>• Enabled</li> <li>• Disabled</li> </ul> <b>Factory settings:</b> Enabled  | <b>SSC2</b> <ul style="list-style-type: none"> <li>• Enabled</li> <li>• Disabled</li> </ul> <b>Factory settings:</b> Enabled  |
| <b>Switching mode</b>                                 | <b>SSC1</b> <ul style="list-style-type: none"> <li>• Deactivated</li> <li>• Single point mode</li> <li>• Two point mode</li> <li>• Windows mode</li> </ul> <b>Factory settings:</b> Single point mode   | <b>SSC2</b> <ul style="list-style-type: none"> <li>• Deactivated</li> <li>• Single point mode</li> <li>• Two point mode</li> <li>• Windows mode</li> </ul> <b>Factory settings:</b> Single point mode |
| <b>Rated operating distance (S<sub>n</sub>)</b>       | 0 - 12 mm ( <b>Factory settings:</b> 12 mm), (ref. target 36x36 mm ST37, 1 mm thick, grounded)  | Non-flush-mounted sensor  |
|   | 0 - 8 mm ( <b>Factory settings:</b> 8 mm), (ref. target 24x24 mm ST37, 1 mm thick, grounded)  | Flush-mounted sensor  |
| <b>Sensitivity control</b>                            | Adjustable by potentiometer, external teach or by IO-Link settings <ul style="list-style-type: none"> <li>• Potentiometer disabled</li> <li>• Potentiometer enabled</li> <li>• External teach</li> </ul> <b>Factory settings:</b> Potentiometer enabled |   |
| <b>Potentiometer</b>                                  | Electrical adjustment   | 11 turns  |
|   | Mechanical adjustment   | 16 turns  |
| <b>Adjustable distance</b>                            | 2 ... 10 mm (flush types)<br><b>Factory settings:</b> SP1 1000 and SP2 10000  |   |
|   | 3 ... 15 mm (Non- flush types)<br><b>Factory settings:</b> SP1 1000 and SP2 10000   |   |
| <b>Effective operating distance (S<sub>r</sub>)</b>   | $0.9 \times S_n \leq S_r \leq 1.1 \times S_n$   |   |
| <b>Usable operating dist. (S<sub>u</sub>)*</b>        | $0.85 \times S_r \leq S_u \leq 1.15 \times S_r$   |   |
| <b>Hysteresis (H)</b><br>CA18FAF08...<br>CA18FAN12... | Adjustable by IO-Link (1% to 100%)<br><b>Factory settings:</b> Typical 4%<br><b>Factory settings:</b> Typical 15%   |   |
| <b>Detection filter</b>                               | This function can increase the immunity towards unstable targets and electromagnetic disturbances: Value can be set from 1 to 255.<br><b>Factory settings:</b> 1<br>(1 is max. operating frequency and 255 is min. operating frequency)                 |   |



\* For Flush-mounted sensors in conductive material, the usable operating distance ( $S_u$ ) is  $0.80 \times S_r \leq S_u \leq 1.2 \times S_r$  for temperatures exceeding  $0^\circ\text{C} - 60^\circ\text{C}$  ( $32^\circ\text{F} - 140^\circ\text{F}$ ).

### Alarm settings

|                                 |  |  |
|---------------------------------|--|--|
| <b>Dust alarm SSC1 and SSC2</b> | <b>SSC1</b><br>• 0 to 100 % of actual SP<br><b>Factory settings:</b> 2 times standard hysteresis   | <b>SSC2</b><br>• 0 to 100 % of actual SP<br><b>Factory settings:</b> 2 times standard hysteresis |
| <b>Temperature alarm</b>        | • High threshold -50 to +150 °C<br>• Low threshold -50 to +150 °C<br><b>Factory settings:</b><br><i>High value 120 °C (front temperature sensor used)</i><br><i>Low value -30 °C (front temperature sensor used)</i> |  |



**Detection diagram**

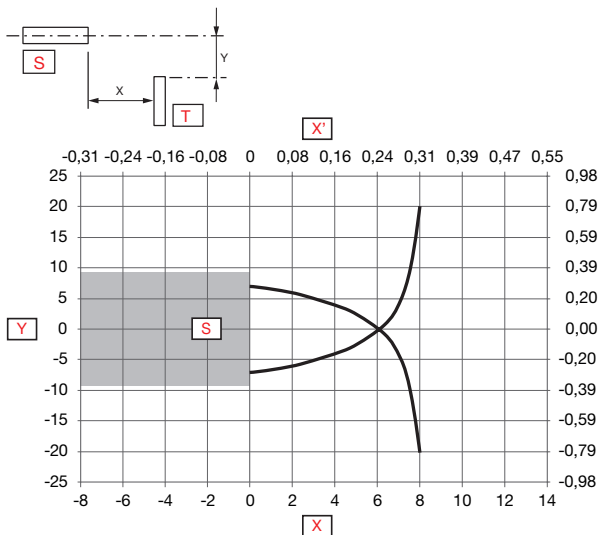

Fig. 4 Flush

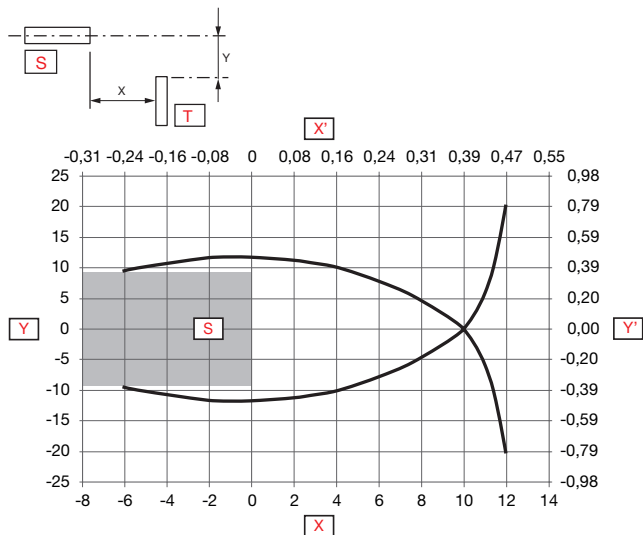

Fig. 5 Non-flush

|    |                          |    |                        |
|----|--------------------------|----|------------------------|
| Y  | Detection width [mm]     | X' | Sensing range [inches] |
| X  | Sensing range [mm]       | S  | Sensor                 |
| Y' | Detection width [inches] | T  | Target                 |

**Accuracy**

|                     |      |
|---------------------|------|
| Repeat accuracy (R) | ≤ 5% |
|---------------------|------|

**Operation diagram**

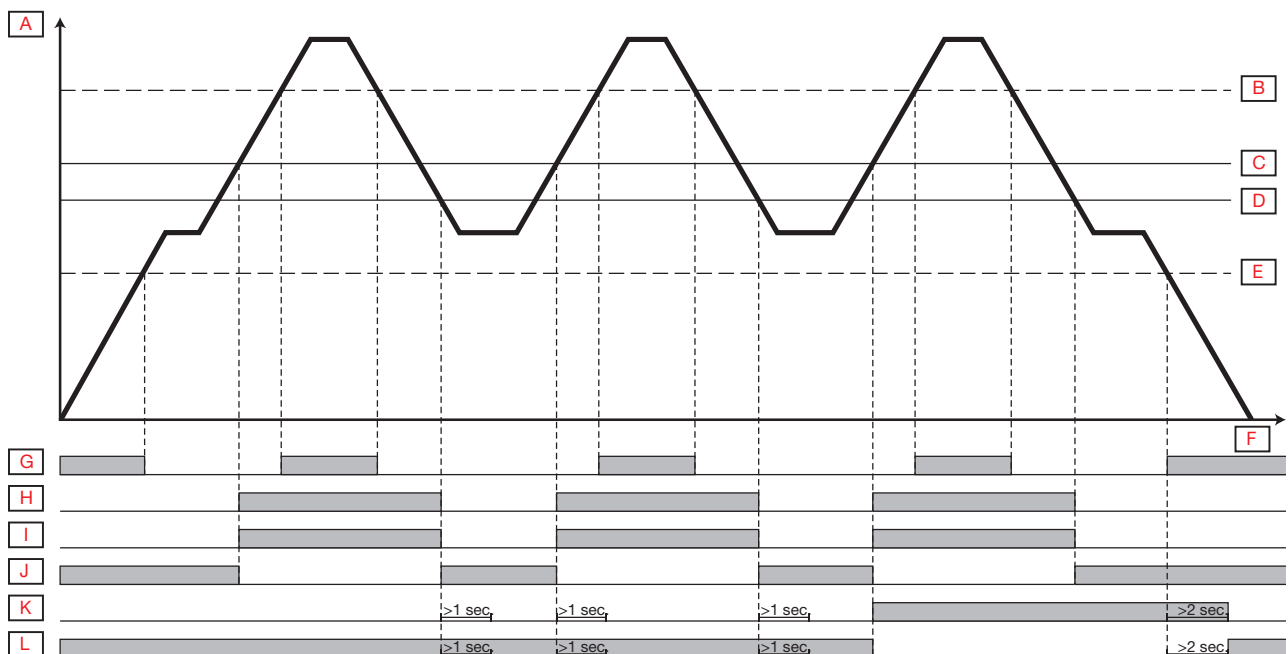



|          |                  |          |                 |
|----------|------------------|----------|-----------------|
| <b>A</b> | Target influence | <b>G</b> | Green LED ON    |
| <b>B</b> | stable ON        | <b>H</b> | Yellow LED ON   |
| <b>C</b> | Output ON        | <b>I</b> | Output N.O.     |
| <b>D</b> | Output OFF       | <b>J</b> | Output N.C.     |
| <b>E</b> | stable OFF       | <b>K</b> | Dust alarm N.O. |
| <b>F</b> | Time             | <b>L</b> | Dust alarm N.C. |



## Features

### Power Supply

|                                     |                                 |
|-------------------------------------|---------------------------------|
| Rated operational voltage ( $U_B$ ) | 10 ... 40 VDC (ripple included) |
| Ripple ( $U_{rpp}$ )                | $\leq 10\%$                     |
| No load supply current ( $I_o$ )    | $\leq 20$ mA                    |
| Rated insulation voltage ( $U_i$ )  | 50 VDC                          |
| Power-ON delay (tv)                 | $\leq 300$ ms                   |

### Input selector

|                |   |   |
|----------------|---|---|
| Input selector | <b>Channel A</b> <ul style="list-style-type: none"> <li>• Deactivated</li> <li>• SSC1</li> <li>• SSC2</li> <li>• Dust alarm 1</li> <li>• Dust alarm 2</li> <li>• Temperature alarm</li> <li>• External input</li> </ul> <b>Factory settings: SSC1</b> | <b>Channel B</b> <ul style="list-style-type: none"> <li>• Deactivated</li> <li>• SSC1</li> <li>• SSC2</li> <li>• Dust alarm 1</li> <li>• Dust alarm 2</li> <li>• Temperature alarm</li> <li>• External input</li> </ul> <b>Factory settings: SSC1</b> |
|----------------|---|---|

### Logic functions

|                 |   |   |
|-----------------|---|---|
| Logic functions | <b>Channel A + B for SO1</b> <ul style="list-style-type: none"> <li>• Direct</li> <li>• AND</li> <li>• OR</li> <li>• X-OR</li> <li>• SR-FF</li> </ul> <b>Factory settings: Direct</b> | <b>Channel A + B for SO2</b> <ul style="list-style-type: none"> <li>• Direct</li> <li>• AND</li> <li>• OR</li> <li>• X-OR</li> <li>• SR-FF</li> </ul> <b>Factory settings: Direct</b> |
|-----------------|---|---|

### Time delays

|                    |   |   |
|--------------------|---|---|
| <b>Timer mode</b>  | <b>For SO1</b> <ul style="list-style-type: none"> <li>• Disabled</li> <li>• Power-ON delay</li> <li>• Power-OFF delay</li> <li>• Power-ON delay and Power-OFF delay</li> <li>• One-shot leading edge</li> <li>• One-shot trailing edge</li> </ul> <b>Factory settings: Disabled</b> | <b>For SO2</b> <ul style="list-style-type: none"> <li>• Disabled</li> <li>• Power-ON delay</li> <li>• Power-OFF delay</li> <li>• Power-ON delay and Power-OFF delay</li> <li>• One-shot leading edge</li> <li>• One-shot trailing edge</li> </ul> <b>Factory settings: Disabled</b> |
| <b>Timer scale</b> | <b>For SO1</b> <ul style="list-style-type: none"> <li>• [ms]</li> <li>• [s]</li> <li>• [min]</li> </ul> <b>Factory settings: ms</b>   | <b>For SO2</b> <ul style="list-style-type: none"> <li>• [ms]</li> <li>• [s]</li> <li>• [min]</li> </ul> <b>Factory settings: ms</b>   |
| <b>Timer value</b> | <b>For SO1</b> <ul style="list-style-type: none"> <li>• 0 ... 32 767</li> </ul> <b>Factory settings: 0</b>  | <b>For SO2</b> <ul style="list-style-type: none"> <li>• 0 ... 32 767</li> </ul> <b>Factory settings: 0</b>  |

### Output Inverter

|                        |   |   |
|------------------------|---|---|
| <b>Output Inverter</b> | <b>For SO1 Pin 4 Black wire:</b> <ul style="list-style-type: none"> <li>• N.O.</li> <li>• N.C.</li> </ul> <b>Factory settings: N.O.</b> | <b>For SO2 Pin 2 White wire:</b> <ul style="list-style-type: none"> <li>• N.O.</li> <li>• N.C.</li> </ul> <b>Factory settings: N.C.</b> |
|------------------------|---|---|

### Sensor Output

|   |   |  |
|---|---|--|
| <b>Switching Output Stage SO1 and SO2</b> | <b>For SO1 Pin 4 Black wire:</b> <ul style="list-style-type: none"> <li>• NPN</li> <li>• PNP</li> <li>• Push-Pull</li> </ul> <b>Factory settings: PNP</b> | <b>For SO2 Pin 2 White wire:</b> <ul style="list-style-type: none"> <li>• NPN</li> <li>• PNP</li> <li>• Push-Pull</li> <li>• External input, active high</li> <li>• External input, active low</li> <li>• External teach</li> </ul> <b>Factory settings: PNP</b> |
|---|---|--|

### Outputs

|  |   |   |
|--|---|---|
| <b>Rated operational current (<math>I_o</math>) (<math>I_e</math>)</b> | ≤ 200 mA (Continuous, SO1 + SO2)            |   |
| <b>OFF-state current (<math>I_o</math>)</b>                            | ≤ 100 μA                                    |   |
| <b>Minimum operational current (<math>I_m</math>)</b>                  | > 0,5 mA                                    |   |
| <b>Voltage drop (<math>U_d</math>)</b>                                 | ≤ 1.0 VDC @ 200 mA DC                       |   |
| <b>Protection</b>  | Short circuit, reverse polarity, transients |   |
| <b>Utilization category</b>  | DC-12                                       | Control of resistive loads and solid-state loads with optical isolation |
|  | DC-13                                       | Control of electromagnets   |
| <b>Load capacitance max at (<math>U_o</math>)</b>                      | 100 nF                                      |   |



**Operation diagram**

**For default factory sensor**

Tv = Power-ON delay

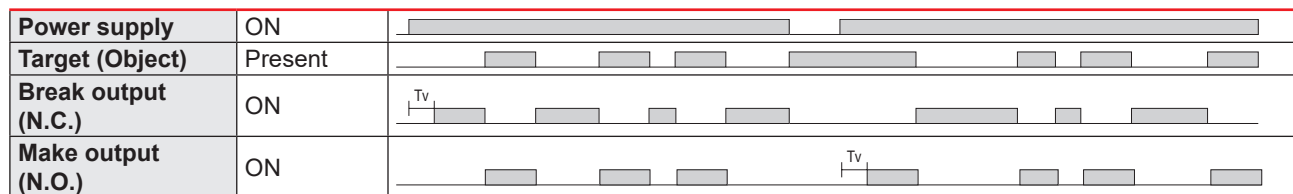

**Response times**

|                                |                           |         |
|--------------------------------|---------------------------|---------|
| <b>Operating frequency (f)</b> | 50 Hz.                    |         |
| <b>Response times</b>          | t <sub>ON</sub> (OFF-ON)  | < 10 ms |
|                                | t <sub>OFF</sub> (ON-OFF) | < 10 ms |

**Indication**

| Green LED   | Yellow LED   | Power | Function  |
|---|--|-------|---|
| <b>SIO and IO-Link mode</b>   |  |       |   |
| ON  | ON   | ON    | ON (stable)* SSC1                                     |
| ON  | OFF  | ON    | OFF (stable)* SSC1                                    |
| OFF   | ON   | -     | ON (Not stable) SSC1                                  |
| OFF   | OFF  | -     | OFF (Not stable) SSC1                                 |
| -   | Flashing 10 Hz<br>50% dutycycle                                | ON    | Output short-circuit                                  |
| -   | Flashing (0.5...20 Hz)   | ON    | Timer indication                                      |
| <b>SIO mode only</b>  |  |       |   |
| -   | Flashing 1 HZ<br>ON 100 ms<br>OFF 900 ms                       | ON    | External teach by wire.<br>Only for single point mode |
| -   | Flashing 1 HZ<br>ON 900 ms<br>OFF 100 ms                       | ON    | Teach time window (3 - 6 sec)                         |
| -   | Flashing 10 HZ<br>ON 50 ms<br>OFF 50 ms<br>Flashing for 2 sec  | ON    | Teach time out (12 sec)                               |
| -   | Flashing 2 HZ<br>ON 250 ms<br>OFF 250 ms<br>Flashing for 2 sec | ON    | Teach successful                                      |
| <b>IO-Link mode only</b>  |  |       |   |
| Flashing 1 HZ<br><b>Stable:</b><br>ON 900 ms<br>OFF 100 ms<br><b>Not stable:</b><br>ON 100 ms<br>OFF 900 ms | -  | ON    | Sensor is in IO-Link mode                             |
| Flashing 2 Hz<br>50% dutycycle  |  | ON    | Find my sensor  |

\*See operation diagram

**LED indication**

|                        |  |
|------------------------|--|
| <b>LED indications</b> | <ul style="list-style-type: none"> <li>• LED Indication disabled</li> <li>• LED Indication enabled</li> <li>• Find my sensor</li> </ul> <p><b>Factory settings:</b> LED Indication enabled</p> |
|------------------------|--|

**Environmental**

|   |                                     |                               |
|---|-------------------------------------|-------------------------------|
| <b>Ambient temperature</b>              | -30°C... +85°C (-22°F... +185°F)    | Operating                     |
|   | -40°C ... +85°C (-40°F ... +185°F)  | Storage                       |
| <b>Max. temperature on sensing face</b> | 120°C (248°F)                       |                               |
| <b>Ambient humidity range</b>           | 35% ... 95%                         | Operating                     |
|   | 35% ... 95%                         | Storage                       |
| <b>Vibration</b>                        | 10 ... 150 Hz, 1 mm / 15 G          | EN 60068-2-6                  |
| <b>Shock</b>                            | 30 G / 11 ms, 3 pos, 3 neg per axis | EN 60068-2-27                 |
| <b>Drop test</b>                        | 2 x 1 m<br>100 x 0,5 m              | EN 60068-2-31                 |
| <b>Rated impulse withstand voltage</b>  | ≥2 kV                               | with 500 Ω                    |
| <b>Overvoltage category</b>             | III                                 | IEC 60664, EN 60947-1         |
| <b>Pollution degree</b>                 | 3                                   | IEC 60664, 60664A; EN 60947-1 |
| <b>IP rating</b>                        | IP 67, IP 68/60 min.,               | EN 60529; EN 60947-1          |
|   | IP69K*                              | DIN 40050-9                   |
| <b>NEMA Enclosure Types</b>             | 1, 2, 4, 4X, 5, 6, 6P, 12           | NEMA 250                      |
| <b>Tightening torque</b>                | ≤ 1 Nm                              |                               |

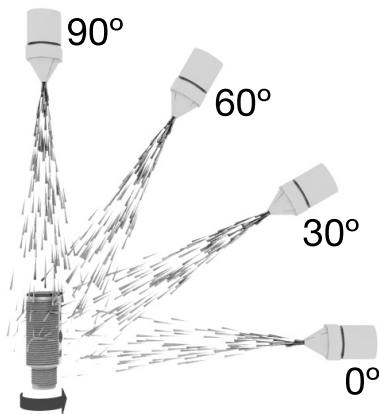

\* The IP69K test according to DIN 40050-9 for high-pressure, high-temperature wash-down applications. The sensor must not only be dust tight (IP6X), but also able to withstand high-pressure and steam cleaning. The sensor is exposed to high pressure water from a spray nozzle that is fed with 80°C water at 8'000– 10'000 KPa (80–100bar) and a flow rate of 14–6L/min. The nozzle is held 100 –150 mm from the sensor at angles of 0°, 30°, 60° and 90° for 30s each. The test device sits on a turntable that rotates with a speed of 5 times per minute. The sensor must not suffer any damaging effects in appearance or function from the high pressure water function.

**TRIPLESHIELD™**

Exceeding the norms for capacitive sensors.

|  |                   |                        |                             |
|--|-------------------|------------------------|-----------------------------|
| <b>Electrostatic discharge immunity test</b> | contact discharge | > 40 kV                | IEC 61000-4-2;<br>EN60947-1 |
|  | air discharge     | > 40 kV                |                             |
| <b>Electromagnetic field immunity</b>        | 20 V/m            |                        | IEC 61000-4-3;<br>EN60947-1 |
| <b>Electrical fast transient immunity</b>    | ±4kV / 5kHz       |                        | IEC 61000-4-4;<br>EN60947-1 |
| <b>Wire-conducted noise</b>                  | > 20 Vrms         |                        | IEC 61000-4-3;<br>EN60947-1 |
| <b>Power frequency magnetic fields</b>       | Continuous        | > 60 A/m, 75.9 μ tesla | IEC 61000-4-8;<br>EN60947-1 |
|  | Short-time        | > 600 A/m, 759 μ tesla |                             |

### Diagnostic parameters

| Function   | Unit     | Range               |
|--|----------|---------------------|
| <b>Values stored in the sensor (Saved every hour)</b>  |          |                     |
| Operating Hours  | [h]      | 0 ... 2 147 483 647 |
| Number of Power Cycles                                 | [cycles] | 0 ... 2 147 483 647 |
| Maximum temperature - All time high                    | [°C]     | -50 ... +150        |
| Minimum temperature - All time low                     | [°C]     | -50 ... +150        |
| Detection counter SSC1                                 | [cycles] | 0 ... 2 147 483 647 |
| Minutes above Maximum Temperature                      | [min]    | 0 ... 2 147 483 647 |
| Minutes below Minimum Temperature                      | [min]    | 0 ... 2 147 483 647 |
| <b>Values stored in the sensor (Saved with events)</b> |          |                     |
| Maintenance event counter                              | [counts] | 0 ... 2 147 483 647 |
| Download counter                                       | [counts] | 0 ... 65 536        |
| <b>Values not saved in sensor</b>                      |          |                     |
| Maximum temperature - Since last power-up              | [°C]     | -50 ... +150        |
| Minimum temperature - Since last power-up              | [°C]     | -50 ... +150        |
| Current temperature                                    | [°C]     | -50 ... +150        |

### Events Configuration

| Events                  | Factory default setting |
|-------------------------|-------------------------|
| Temperature fault event | Inactive                |
| Temperature over-run    | Inactive                |
| Temperature under-run   | Inactive                |
| Short circuit           | Inactive                |
| Maintenance             | Inactive                |

### Process data configuration

| Process Data                     | Factory default setting |
|----------------------------------|-------------------------|
| Analogue value                   | Active                  |
| SO1, Switching output 1          | Active                  |
| SO2, Switching output 2          | Active                  |
| SSC1, Sensor switching channel 1 | Inactive                |
| SSC2, Sensor switching channel 2 | Inactive                |
| DA1, Dust Alarm for SSC1         | Inactive                |
| DA2, Dust alarm for SSC2         | Inactive                |
| TA, Temperature alarm            | Inactive                |
| SC, Short circuit                | Inactive                |

## Process data structure

4 Bytes, Analogue value 16 ... 31 (16 bit)

|        |            |    |           |           |            |            |             |             |
|--------|------------|----|-----------|-----------|------------|------------|-------------|-------------|
| Byte 0 | 31         | 30 | 29        | 28        | 27         | 26         | 25          | 24          |
|        | <b>MSB</b> | -  | -         | -         | -          | -          | -           | -           |
| Byte 1 | 23         | 22 | 21        | 20        | 19         | 18         | 17          | 16          |
|        | -          | -  | -         | -         | -          | -          | -           | <b>LSB</b>  |
| Byte 2 | 15         | 14 | 13        | 12        | 11         | 10         | 9           | 8           |
|        | -          | -  | <b>SC</b> | <b>TA</b> | <b>DA2</b> | <b>DA1</b> | <b>SSC2</b> | <b>SSC1</b> |
| Byte 3 | 7          | 6  | 5         | 4         | 3          | 2          | 1           | 0           |
|        | -          | -  | -         | -         | -          | -          | <b>SO2</b>  | <b>SO1</b>  |

## Mechanics/electronics

### Connection

|                  |   |
|------------------|---|
| <b>Cable</b>     | 2 m, 4 wire, 4 x 0,34 mm <sup>2</sup> , Ø5.2 mm Oil proof PVC, grey |
| <b>Plug (M1)</b> | M12 x 1, 4 pin male   |

### Wiring

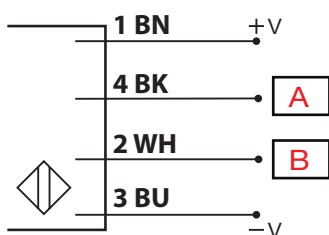

| BN    | BK    | WH    | BU   | A           | B      |
|-------|-------|-------|------|-------------|--------|
| Brown | Black | White | Blue | OUT/IO-Link | IN/OUT |

### Housing

|                      |                             |               |
|----------------------|-----------------------------|---------------|
| <b>Body</b>          | PTFE                        |               |
| <b>Cable gland</b>   | Grilamid TR 55, Black       |               |
| <b>Nuts</b>          | PTFE                        |               |
| <b>Trimmer shaft</b> | Nylon, Blue                 |               |
| <b>Light guides</b>  | Grilamid TR 55, Transparent |               |
| <b>Dimensions</b>    | M18 x 1                     | Thread        |
| <b>Thread length</b> | 47 mm                       | Non-flush     |
|                      | 55 mm                       | Flush         |
| <b>Total length</b>  | 70 mm                       | Housing       |
| <b>Weight</b>        | ≤ 137 g                     | Cable version |
|                      | ≤ 62 g                      | Plug version  |



**Dimensions (mm)**

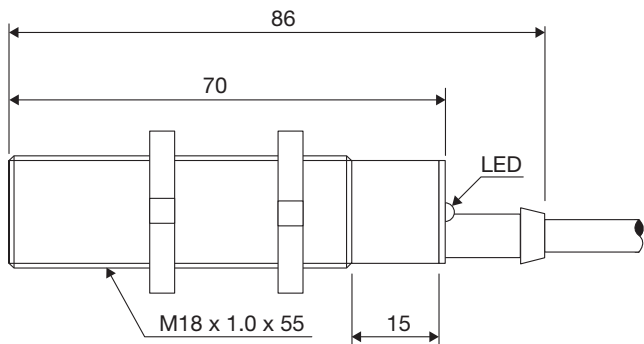

**Fig. 6 Cable CA18EAF...A2IO**

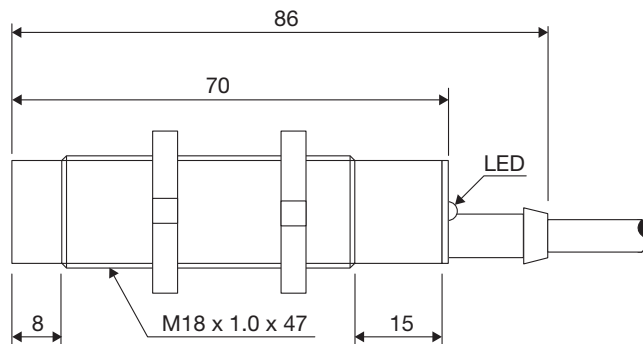

**Fig. 7 Cable CA18EAN...A2IO**

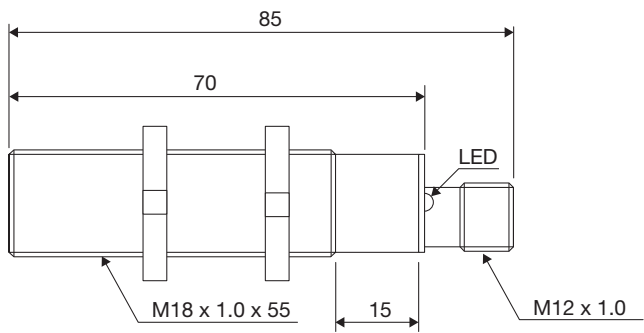

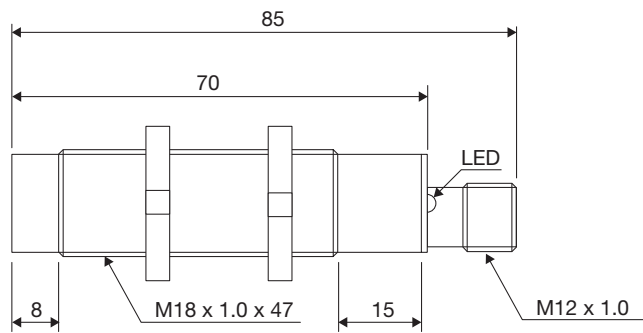

**Fig. 8 Plug CA18EAF...M1IO**



**Fig. 9 Plug CA18EAN...M1IO**

## Compatibility and conformity

### ▶ Approvals and markings

|                          |   |  |
|--------------------------|---|--|
| <b>General reference</b> | Sensor designed according to EN60947-5-2 and EN60947-1                            |  |
| <b>MTTF<sub>d</sub></b>  | 114.6 years @ 40°C (+104°F)   | ISO 13849-1, SN 29500  |
| <b>CE-marking</b>        |  |  |
| <b>Approvals</b>         |  |  |
| <b>Other Approvals</b>   |  | Topax 56, Topaz AC1, Topaz MD3, Topaz CL1, Topactiv OKTO, P3-hypochloran |

### ▶ IO-Link

|                               |  |
|-------------------------------|--|
| <b>IO-Link revision</b>       | 1.1  |
| <b>Transmission rate</b>      | COM2 (38.4 kbaud)                                |
| <b>SDCI-Norm</b>              | IEC 61131-9                                      |
| <b>Profile</b>                | Smart sensor profile 2nd edition, common profile |
| <b>Min. cycle time</b>        | 5 ms   |
| <b>SIO mode</b>               | Yes  |
| <b>Min. master port class</b> | A (4-pin)  |
| <b>Process data length</b>    | 32 bit   |