

CAB006A12GM3

1200 V, 6 mΩ All-Silicon Carbide Half-Bridge Module

V_{DS}	1200 V
$R_{DS(on)}$	6 mΩ

Technical Features

- Ultra-Low Loss
- High Frequency Operation
- Zero Turn-Off Tail Current from MOSFET
- Normally-Off, Fail-Safe Device Operation
- Aluminum Nitride Ceramic Substrate

Applications

- EV Chargers
- Solar
- High-Efficiency Converters / Inverters
- Motor & Traction Drives
- Smart-Grid / Grid-Tied Distributed Generation

Package

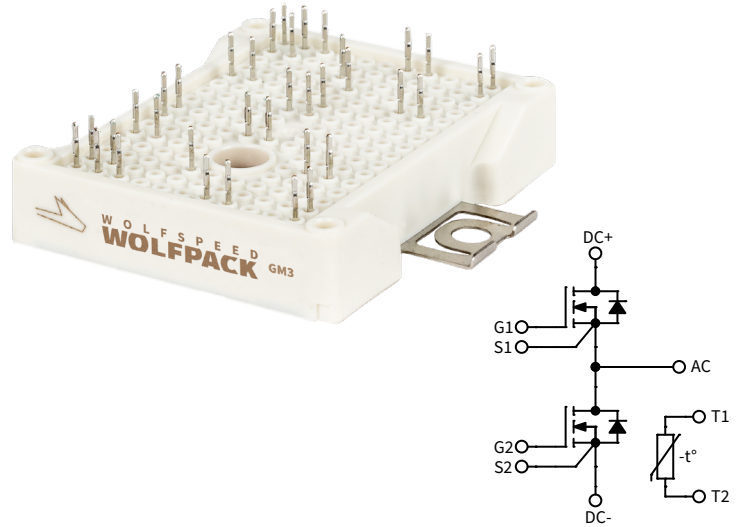

System Benefits

- Enables Compact, Lightweight Systems
- Increased System Efficiency, due to Low Switching & Conduction Losses of SiC
- Reduced Thermal Requirements and System Cost

Maximum Parameters (Verified by Design)

Symbol	Parameter	Min.	Typ.	Max.	Unit	Test Conditions	Note
$V_{DS\ max}$	Drain-Source Voltage			1200			
$V_{GS\ max}$	Gate-Source Voltage, Maximum Value	-8		+19	V	Transient, <100 ns	Fig. 33
$V_{GS\ op}$	Gate-Source Voltage, Recommended	-4		+15		Static	
I_D	DC Continuous Drain Current ($T_{VJ} \leq 150\ ^\circ\text{C}$)			200	A	$V_{GS} = 15\ \text{V}, T_{HS} = 75\ ^\circ\text{C}, T_{VJ} \leq 150\ ^\circ\text{C}$	Note 1
	DC Continuous Drain Current ($T_{VJ} \leq 175\ ^\circ\text{C}$)			200		$V_{GS} = 15\ \text{V}, T_{HS} = 75\ ^\circ\text{C}, T_{VJ} \leq 175\ ^\circ\text{C}$	
$I_{SD\ BD}$	DC Source-Drain Current (Body Diode)		159			$V_{GS} = -4\ \text{V}, T_{HS} = 75\ ^\circ\text{C}, T_{VJ} \leq 175\ ^\circ\text{C}$	
$I_{D\ (pulsed)}$	Maximum Pulsed Drain Current			400		t_{Pmax} limited by T_{VJ-max} $V_{GS} = 15\ \text{V}, T_{HS} = 75\ ^\circ\text{C}$	
$T_{VJ\ op}$	Maximum Virtual Junction Temperature under Switching Conditions	-40		150	$^\circ\text{C}$	Operation	
		-40		175	$^\circ\text{C}$	Intermittent with Reduced Life	

Note 1 DC continuous drain current, I_D , set by press-fit pin limit.

MOSFET Characteristics (Per Position) ($T_{VJ} = 25^\circ\text{C}$ unless otherwise specified)

Symbol	Parameter	Min.	Typ.	Max.	Unit	Test Conditions	Note
$V_{(BR)DSS}$	Drain-Source Breakdown Voltage	1200			V	$V_{GS} = 0\text{ V}, T_{VJ} = -40^\circ\text{C}$	
$V_{GS(th)}$	Gate Threshold Voltage	1.8	2.5	3.6		$V_{DS} = V_{GS}, I_D = 69\text{ mA}$	
			2.1			$V_{DS} = V_{GS}, I_D = 69\text{ mA}, T_{VJ} = 150^\circ\text{C}$	
I_{DSS}	Zero Gate Voltage Drain Current		6	114	μA	$V_{GS} = 0\text{ V}, V_{DS} = 1200\text{ V}$	
I_{GSS}	Gate-Source Leakage Current		0.06	1.5		$V_{GS} = 15\text{ V}, V_{DS} = 0\text{ V}$	
$R_{DS(on)}$	Drain-Source On-State Resistance (Devices Only)		5.3	6.9	m Ω	$V_{GS} = 15\text{ V}, I_D = 200\text{ A}$	Fig. 2 Fig. 3
			8.5			$V_{GS} = 15\text{ V}, I_D = 200\text{ A}, T_{VJ} = 150^\circ\text{C}$	
			9.6			$V_{GS} = 15\text{ V}, I_D = 200\text{ A}, T_{VJ} = 175^\circ\text{C}$	
g_{fs}	Transconductance		162		S	$V_{DS} = 20\text{ V}, I_{DS} = 200\text{ A}$	Fig. 4
			145			$V_{DS} = 20\text{ V}, I_{DS} = 200\text{ A}, T_{VJ} = 150^\circ\text{C}$	
E_{On}	Turn-On Switching Energy, $T_{VJ} = 25^\circ\text{C}$ $T_{VJ} = 125^\circ\text{C}$ $T_{VJ} = 150^\circ\text{C}$		4.76		mJ	$V_{DD} = 600\text{ V},$ $I_D = 200\text{ A},$ $V_{GS} = -4\text{ V}/15\text{ V},$ $R_{G(OFF)} = 0.0\ \Omega, R_{G(ON)} = 1.5\ \Omega,$ $L = 40\ \mu\text{H}$	Fig. 11 Fig. 13
			5.12				
			5.41				
E_{Off}	Turn-Off Switching Energy, $T_{VJ} = 25^\circ\text{C}$ $T_{VJ} = 125^\circ\text{C}$ $T_{VJ} = 150^\circ\text{C}$		0.44				
			0.45				
			0.46				
$R_{G(int)}$	Internal Gate Resistance		1.12		Ω	$f = 100\text{ kHz}, V_{AC} = 25\text{ mV}$	
C_{iss}	Input Capacitance		20.4		nF	$V_{GS} = 0\text{ V}, V_{DS} = 800\text{ V},$ $V_{AC} = 25\text{ mV}, f = 100\text{ kHz}$	Fig. 9
C_{oss}	Output Capacitance		0.79				
C_{rss}	Reverse Transfer Capacitance		43				
Q_{GS}	Gate to Source Charge		240		nC	$V_{DS} = 800\text{ V}, V_{GS} = -4\text{ V}/15\text{ V}$ $I_D = 200\text{ A}$ Per IEC60747-8-4 pg 21	
Q_{GD}	Gate to Drain Charge		204				
Q_G	Total Gate Charge		708				
$R_{th JH}$	FET Thermal Resistance, Junction to Heatsink		0.137		$^\circ\text{C}/\text{W}$		Fig. 17



Diode Characteristics (Per Position) ($T_{VJ} = 25^{\circ}\text{C}$ unless otherwise specified)

Symbol	Parameter	Min.	Typ.	Max.	Unit	Test Conditions	Note
V_{SD}	Body Diode Forward Voltage		4.9		V	$V_{GS} = -4\text{ V}, I_{SD} = 200\text{ A}$	Fig. 7
			4.4			$V_{GS} = -4\text{ V}, I_{SD} = 200\text{ A}, T_{VJ} = 150^{\circ}\text{C}$	
			4.3			$V_{GS} = -4\text{ V}, I_{SD} = 200\text{ A}, T_{VJ} = 175^{\circ}\text{C}$	
t_{rr}	Reverse Recovery Time		29		ns	$V_{GS} = -4\text{ V}, I_{SD} = 200\text{ A}, V_R = 600\text{ V}$ $di/dt = 20.0\text{ A/ns}, T_{VJ} = 150^{\circ}\text{C}$	Fig. 32
Q_{RR}	Reverse Recovery Charge		4.8		μC		
I_{RRM}	Peak Reverse Recovery Current		275		A		
E_{RR}	Reverse Recovery Energy, $T_{VJ} = 25^{\circ}\text{C}$ $T_{VJ} = 125^{\circ}\text{C}$ $T_{VJ} = 150^{\circ}\text{C}$		0.14		mJ	$V_{DD} = 600\text{ V}, I_D = 200\text{ A},$ $V_{GS} = -4\text{ V}/15\text{ V}, R_{G(ON)} = 1.5\ \Omega,$ $L = 40\ \mu\text{H}$	Fig. 14
			0.45				
			0.63				

Module Physical Characteristics

Symbol	Parameter	Min.	Typ.	Max.	Unit	Test Conditions
R_{HS}	Package Resistance, M1 (High-Side)		0.98		m Ω	$T_C = 25^{\circ}\text{C}, I_D = 200\text{ A}, \text{Note 2}$
			1.37			$T_C = 125^{\circ}\text{C}, I_D = 200\text{ A}, \text{Note 2}$
R_{LS}	Package Resistance, M2 (Low-Side)		0.90		m Ω	$T_C = 25^{\circ}\text{C}, I_D = 200\text{ A}, \text{Note 2}$
			1.25			$T_C = 125^{\circ}\text{C}, I_D = 200\text{ A}, \text{Note 2}$
L_{Stray}	Stray Inductance		7.1		nH	Between DC- and DC+, $f = 10\text{ MHz}$
T_C	Case Temperature	-40		125	$^{\circ}\text{C}$	
W	Weight		39		g	
M_S	Mounting Torque		2.0	2.3	N-m	M4 bolts
V_{isol}	Case Isolation Voltage		3		kV	AC, 50 Hz, 1 min
CTI	Comparative Tracking Index	200				
	Clearance Distance		5.0		mm	Terminal to Terminal
			10.0			Terminal to Heatsink
	Creepage Distance		6.3		mm	Terminal to Terminal
			11.5			Terminal to Heatsink

Note 2 Total Effective Resistance (Per Switch Position) = MOSFET $R_{DS(on)}$ + Switch Position Package Resistance.

NTC Thermistor Characterization

Symbol	Parameter	Min.	Typ.	Max.	Unit	Test Conditions	Note
R_{NTC}	Rated Resistance		5.0		k Ω	$T_{NTC} = 25^{\circ}\text{C}$	Fig. 23
$\Delta R/R$	Resistance Tolerance at 25°C	-5		5	%		
$\beta_{25/50}$	Beta Value ($T_2 = 50^{\circ}\text{C}$)		3380		K		
$\beta_{25/80}$	Beta Value ($T_2 = 80^{\circ}\text{C}$)		3468		K		
$\beta_{25/100}$	Beta Value ($T_2 = 100^{\circ}\text{C}$)		3523		K		
P_{Max}	Power Dissipation			10	mW	$T_{NTC} = 25^{\circ}\text{C}$	

Typical Performance

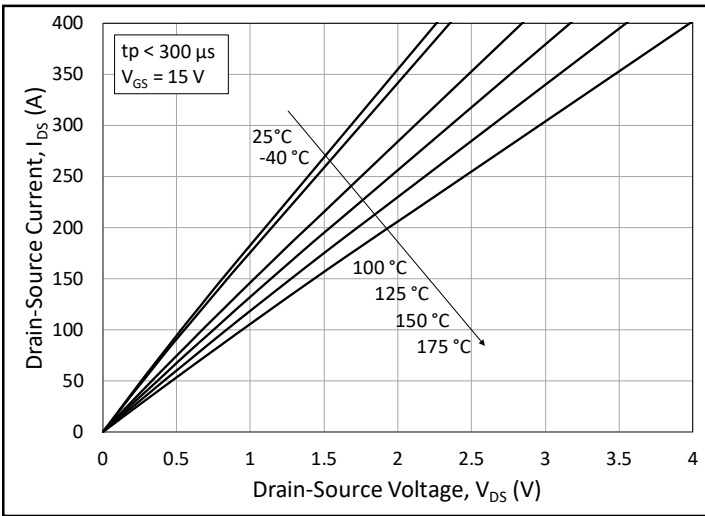

Figure 1. Output Characteristics for Various Junction Temperatures

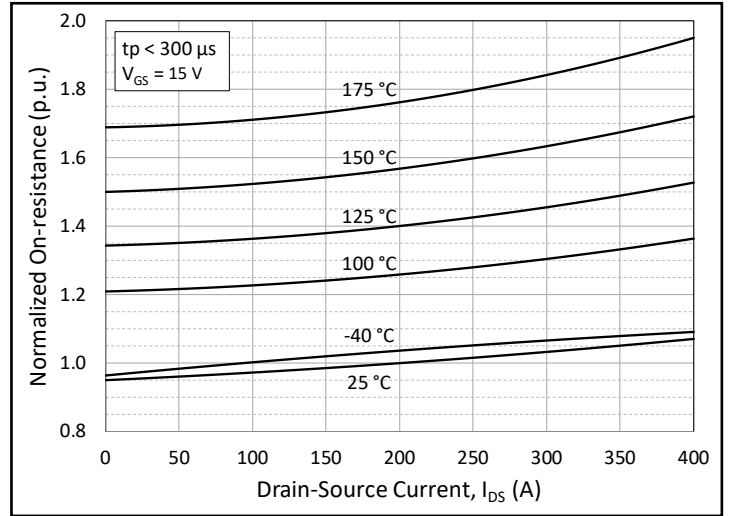

Figure 2. Normalized On-State Resistance vs. Drain Current for Various Junction Temperatures

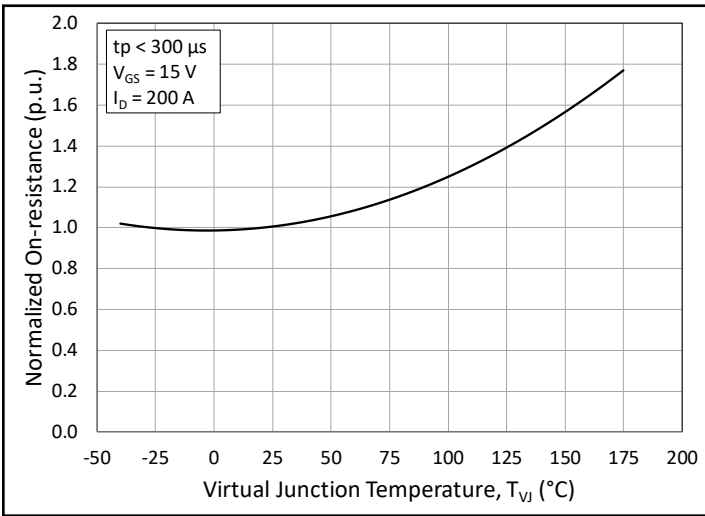

Figure 3. Normalized On-State Resistance vs. Junction Temperature

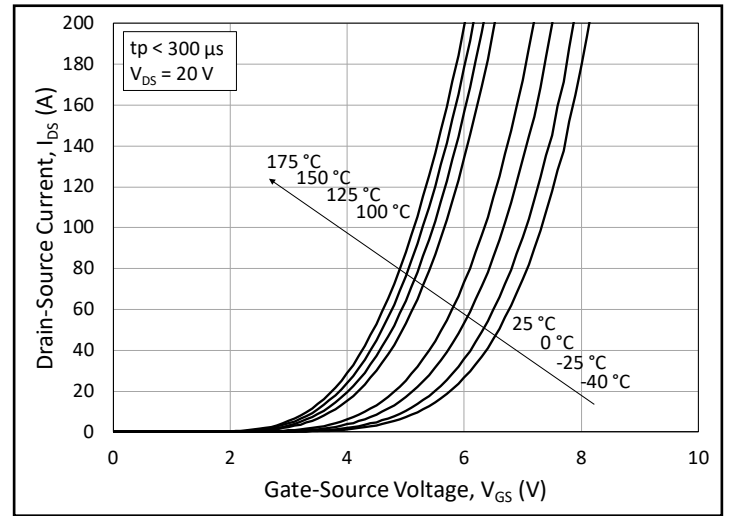

Figure 4. Transfer Characteristic for Various Junction Temperatures

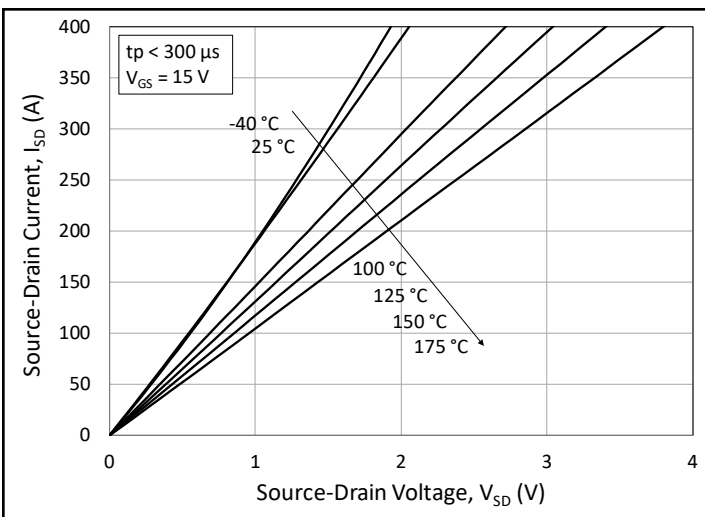

Figure 5. 3rd Quadrant Characteristic vs. Junction Temperatures at $V_{GS} = 15\text{ V}$

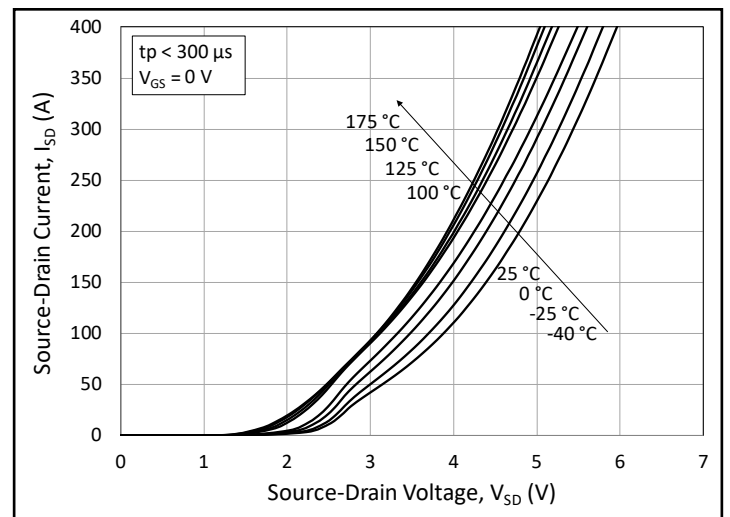

Figure 6. 3rd Quadrant Characteristic vs. Junction Temperatures at $V_{GS} = 0\text{ V}$ (Body Diode)

Typical Performance

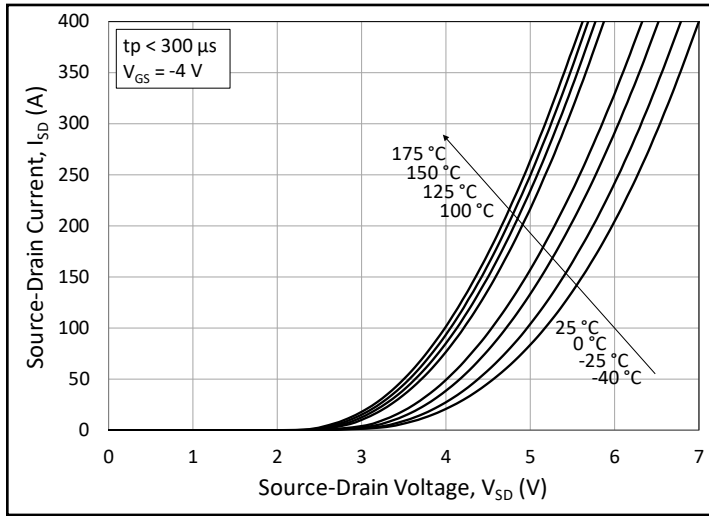

Figure 7. 3rd Quadrant Characteristic vs. Junction Temperatures at $V_{GS} = -4$ V (Body Diode)

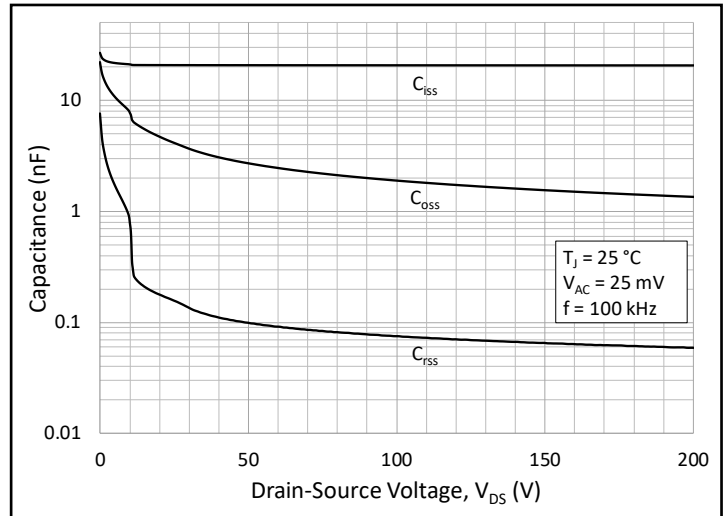

Figure 8. Typical Capacitances vs. Drain to Source Voltage (0 - 200V)

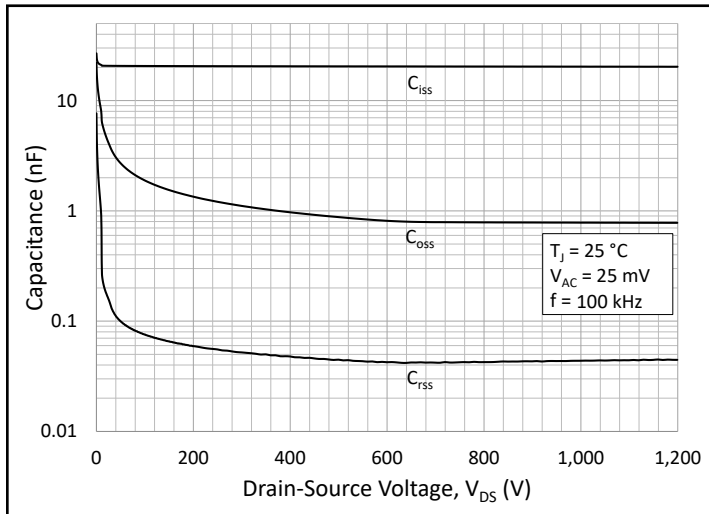

Figure 9. Typical Capacitances vs. Drain to Source Voltage (0 - 1200V)

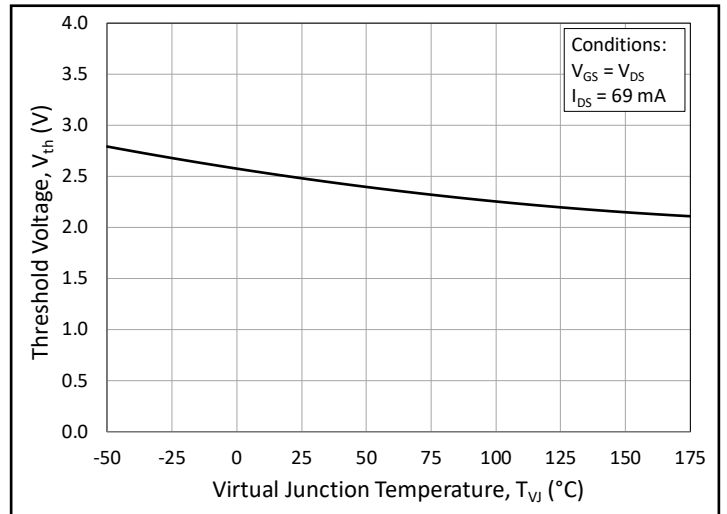

Figure 10. Threshold Voltage vs. Junction Temperature

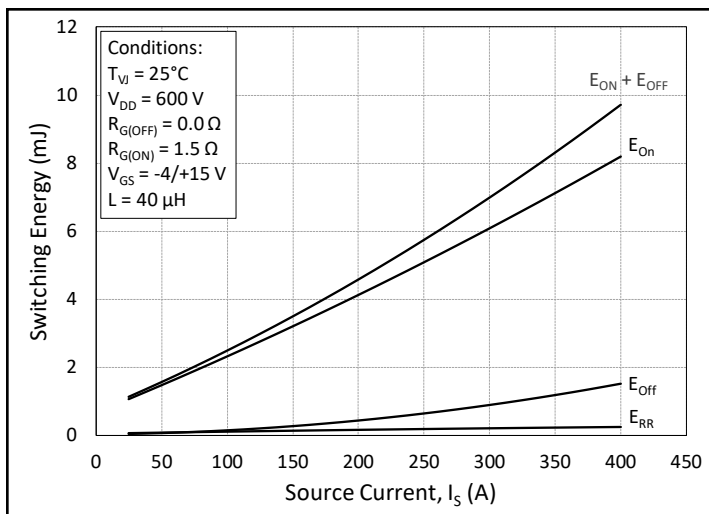

Figure 11. Switching Energy vs. Drain Current ($V_{DS} = 600$ V)

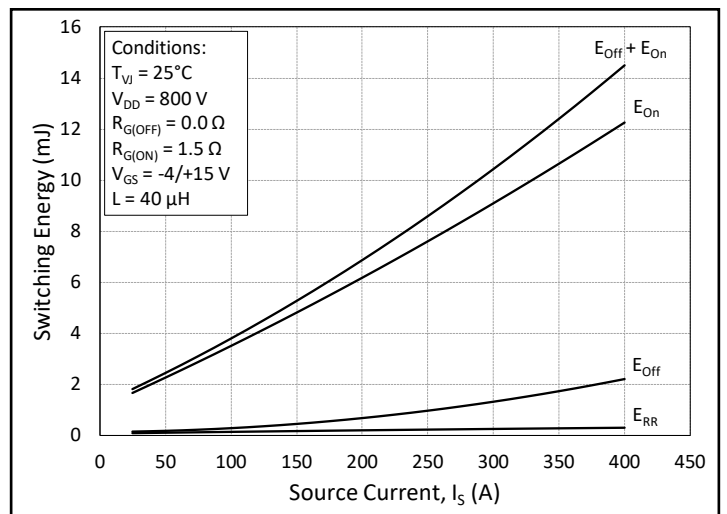

Figure 12. Switching Energy vs. Drain Current ($V_{DS} = 800$ V)

Typical Performance

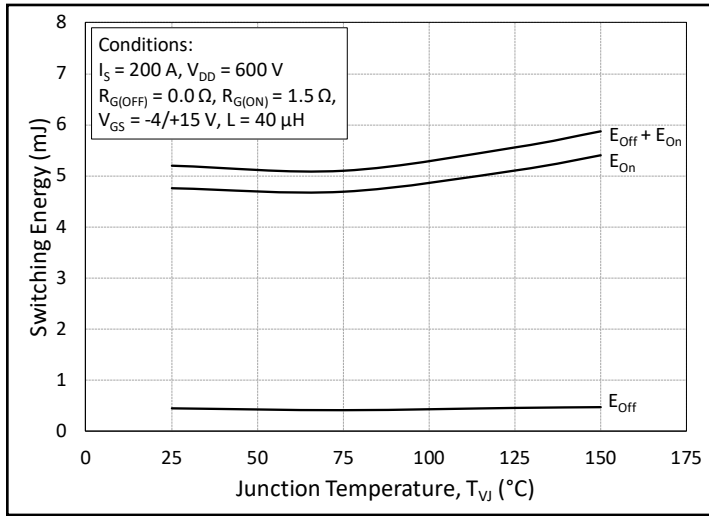

Figure 13. MOSFET Switching Energy vs. Junction Temperature

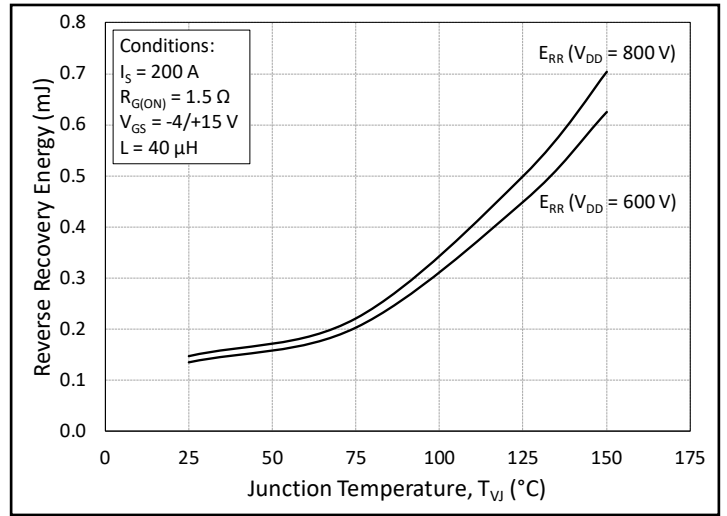

Figure 14. Reverse Recovery Energy vs. Junction Temperature

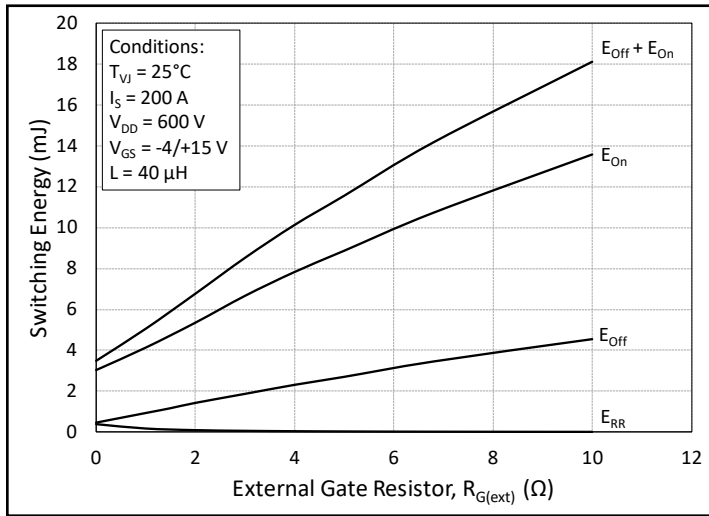

Figure 15. MOSFET Switching Energy vs. External Gate Resistance

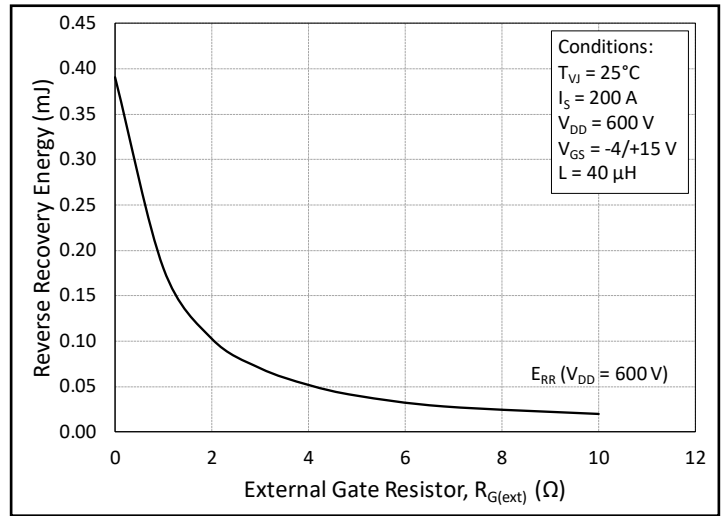

Figure 16. Reverse Recovery Energy vs. External Gate Resistance

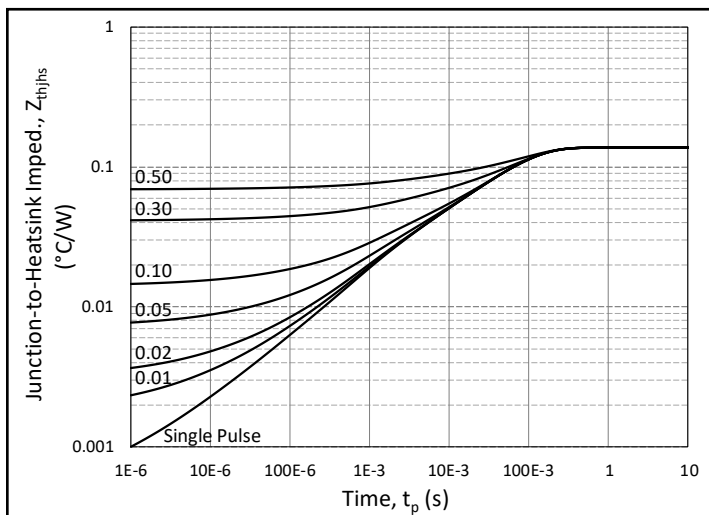

Figure 17. MOSFET Junction to Heatsink Transient Thermal Impedance, $Z_{th\ JHS}$ (°C/W)

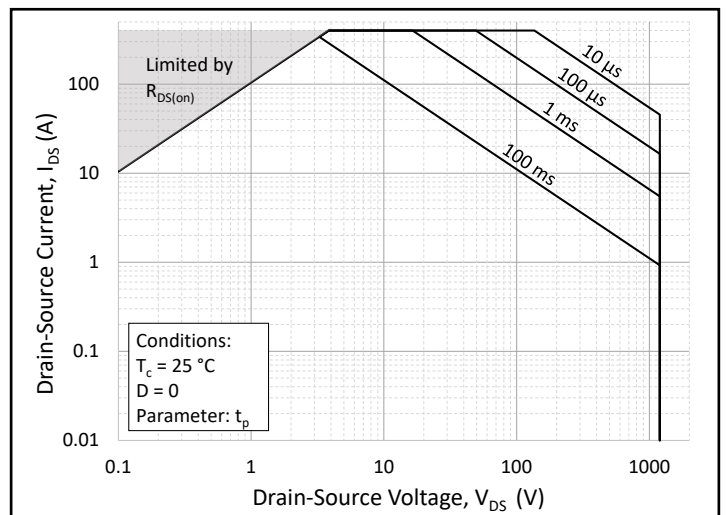

Figure 18. Forward Bias Safe Operating Area (FBSOA)

Typical Performance

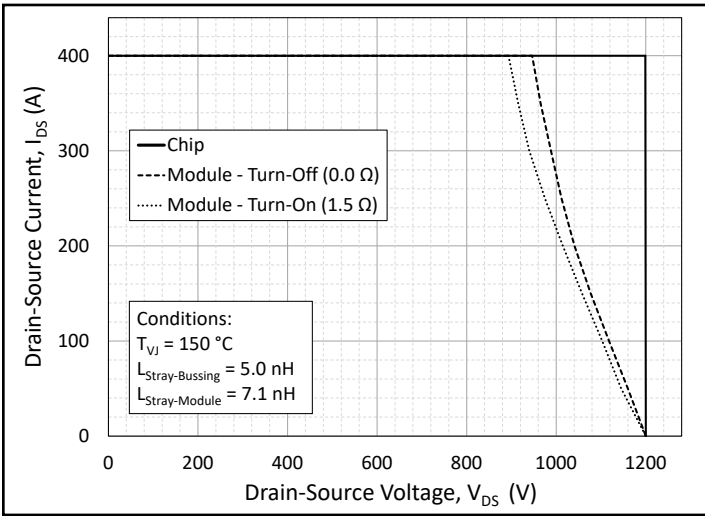

Figure 19. Reverse Bias Safe Operating Area (RBSOA)

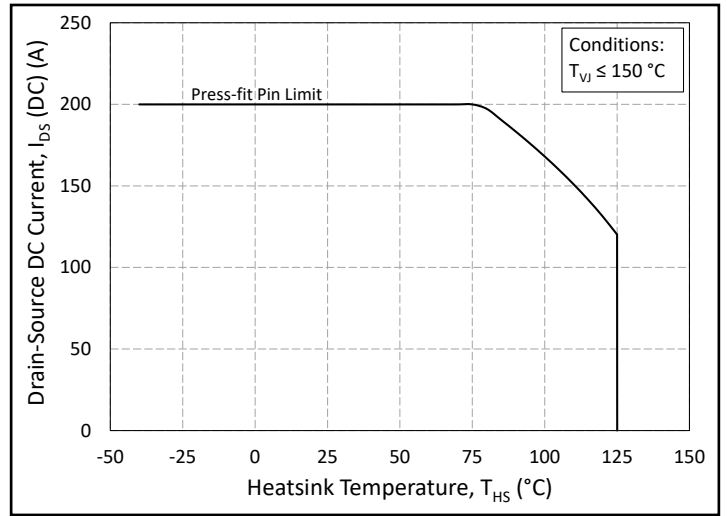

Figure 20. Continuous Drain Current Derating vs. Heatsink Temperature

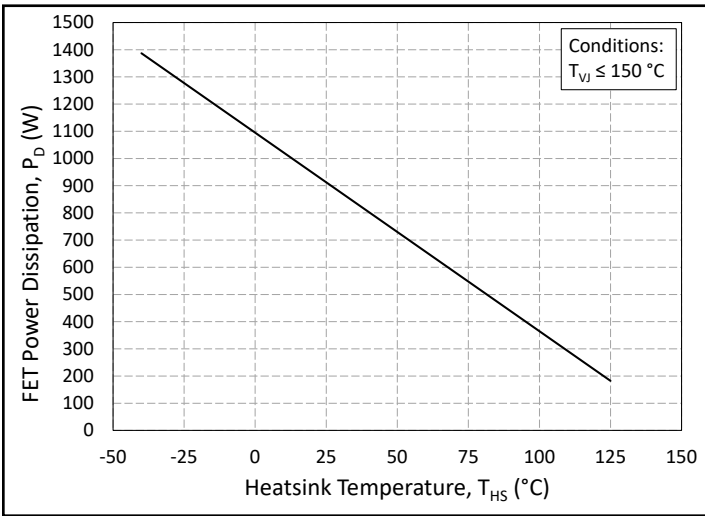

Figure 21. Maximum Power Dissipation Derating vs. Heatsink Temperature

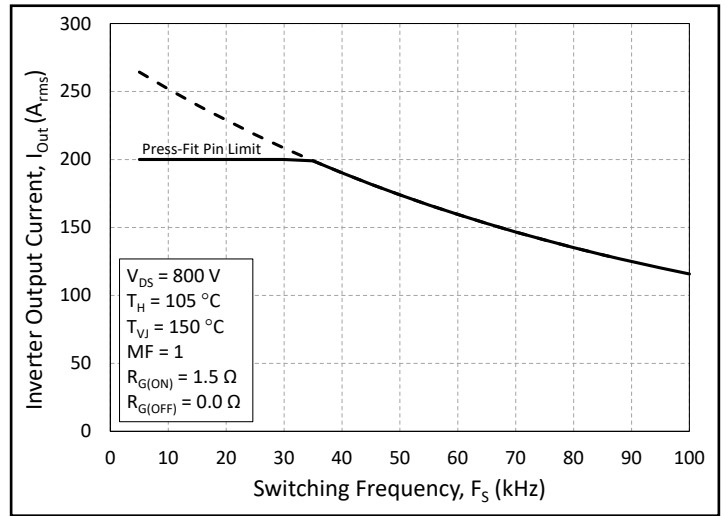

Figure 22. Typical Output Current Capability vs. Switching Frequency (Inverter Application)

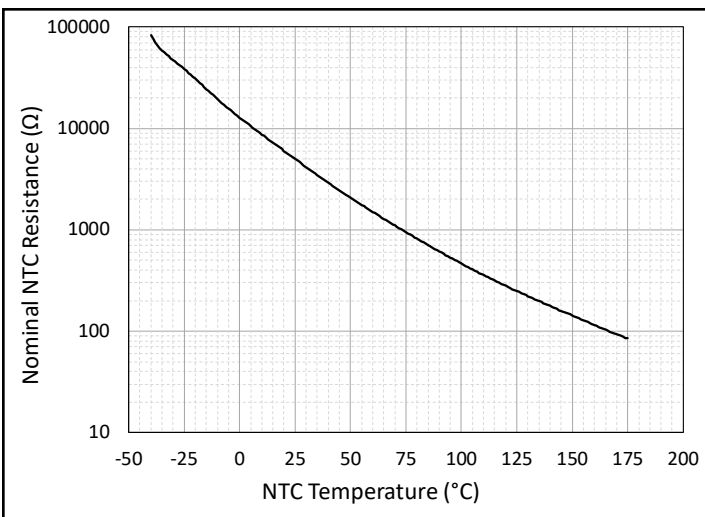

Figure 23. Nominal NTC Resistance vs. NTC Temperature



Timing Characteristics

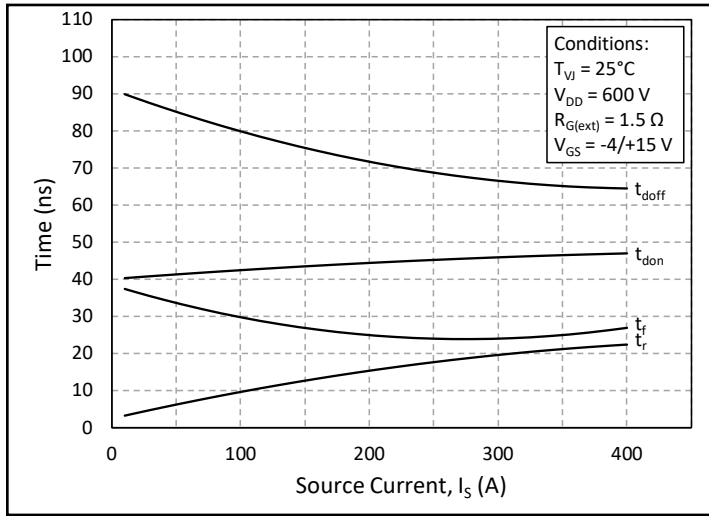

Figure 24. Timing vs. Source Current

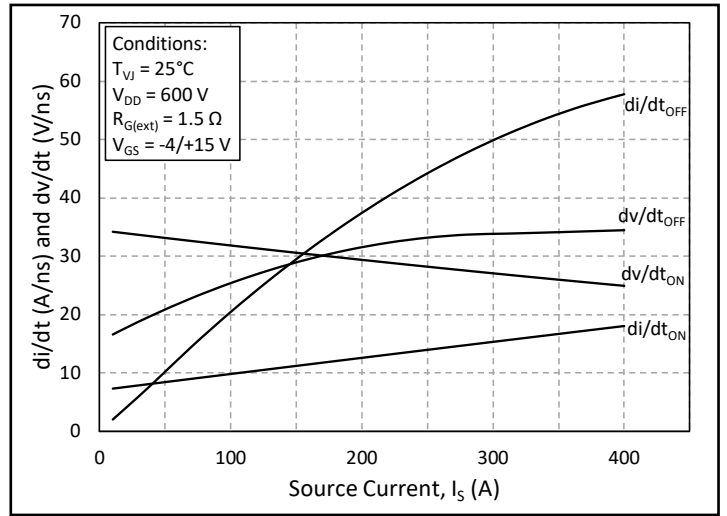

Figure 25. dv/dt and di/dt vs. Source Current

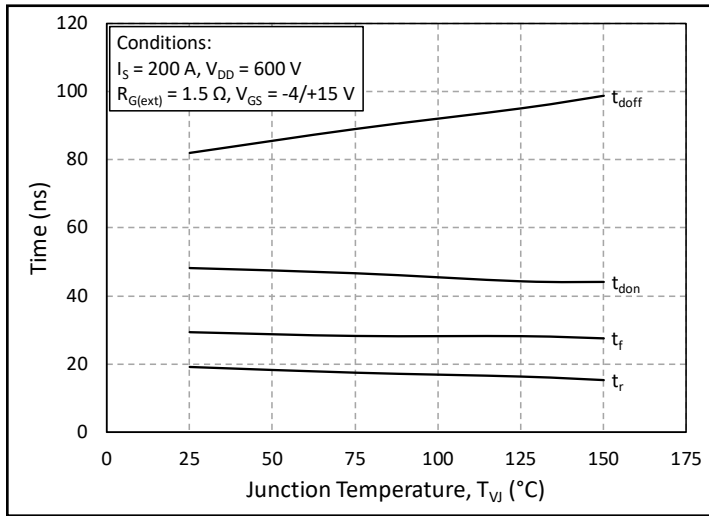

Figure 26. Timing vs. Junction Temperature

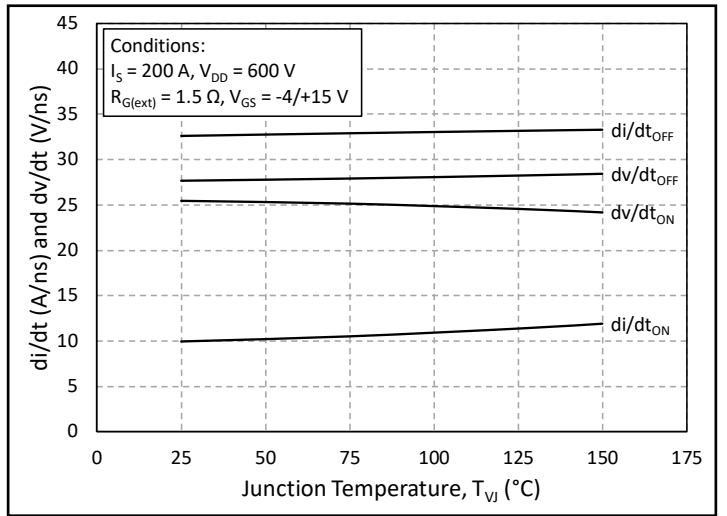

Figure 27. dv/dt and di/dt vs. Junction Temperature

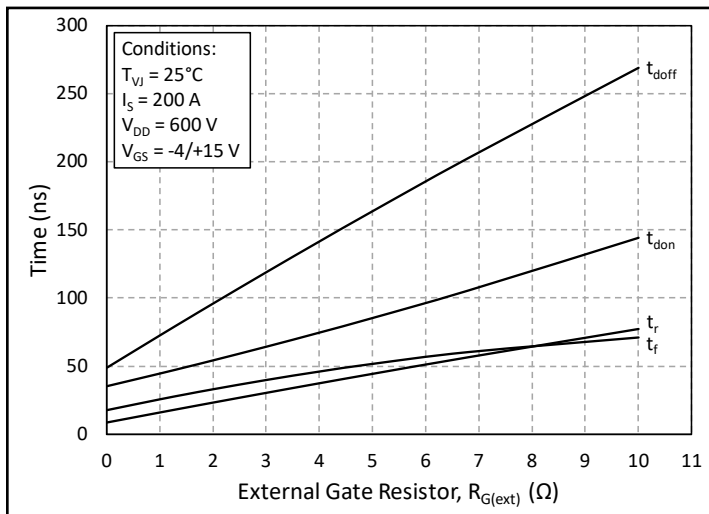

Figure 28. Timing vs. External Gate Resistance

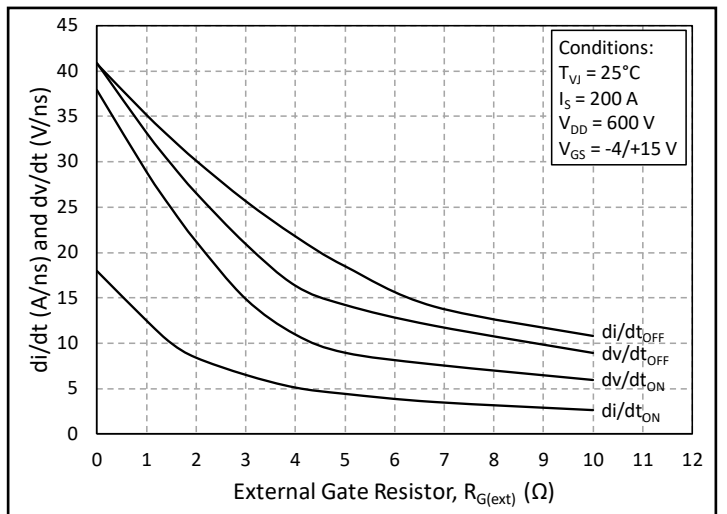

Figure 29. dv/dt and di/dt vs. External Gate Resistance



Definitions

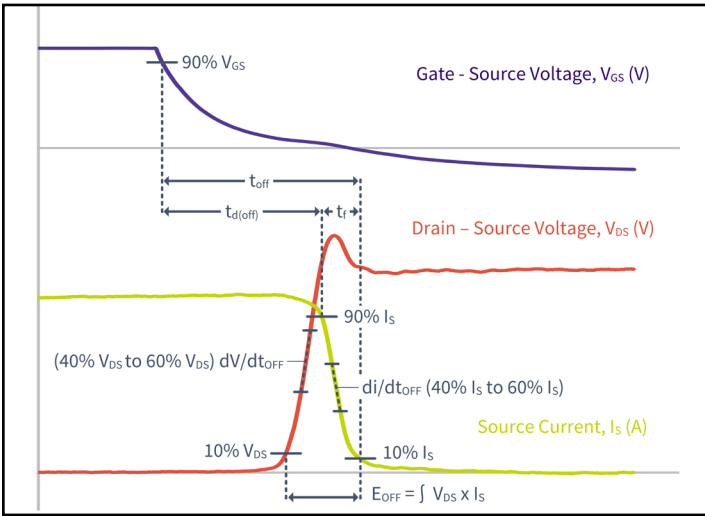

Figure 30. Turn-off Transient Definitions

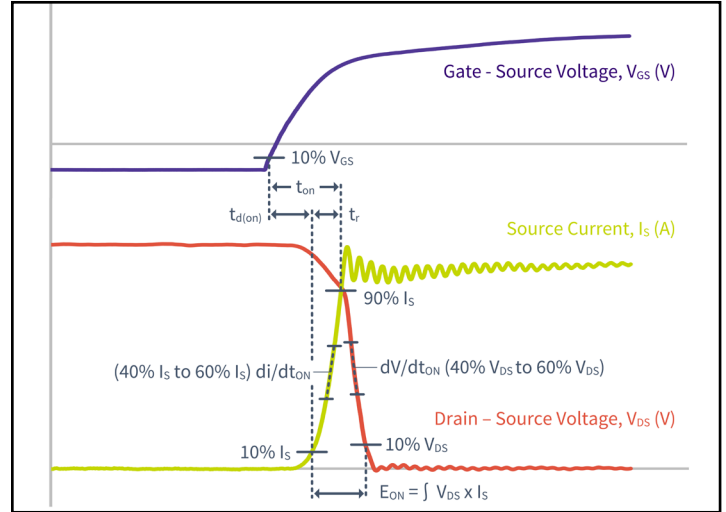

Figure 31. Turn-on Transient Definitions

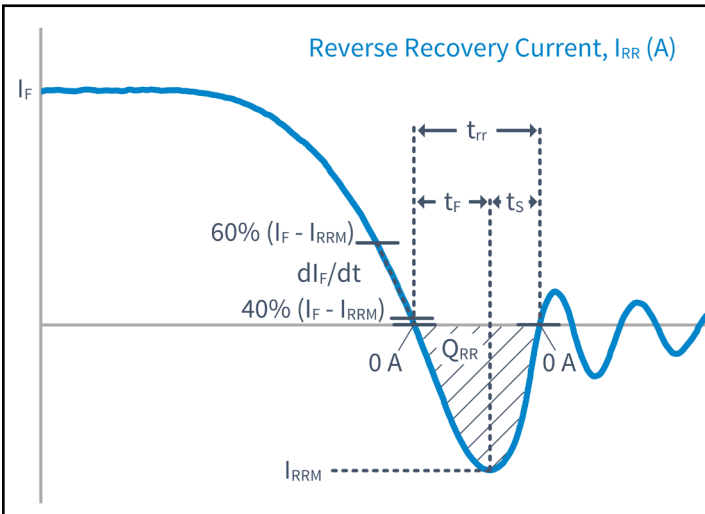

Figure 32. Reverse Recovery Definitions

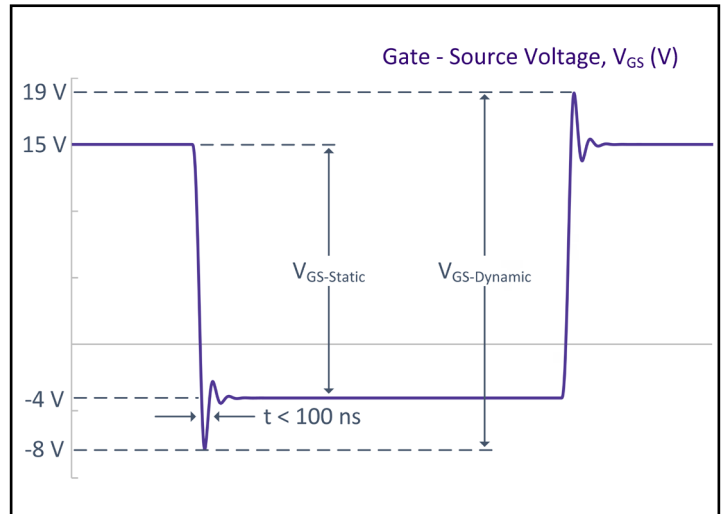
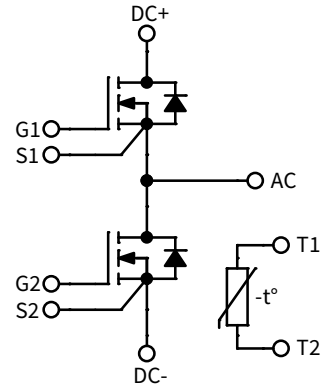
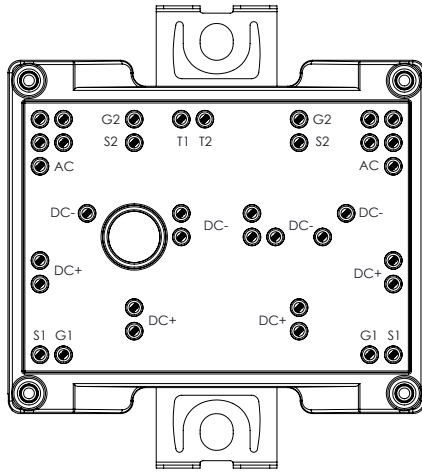

Figure 33. V_{GS} Transient Definitions



Schematic and Pin Out



Package Dimension (mm)

