

CAB500M17HM3

1700 V, 500 A, Silicon Carbide, Half-Bridge Module

V_{DS}	1700 V
I_{DS}	500 A

Technical Features

- Ultra-Low Loss
- High Frequency Operation
- Zero Turn-Off Tail Current from MOSFET
- Normally-Off, Fail-Safe Device Operation

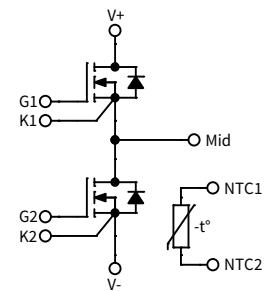
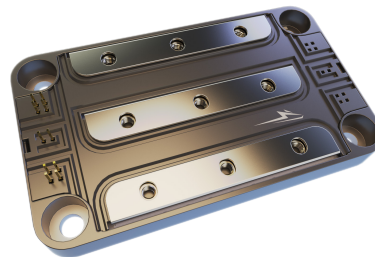

Applications

- Railway, Traction, and Motor Drives
- EV Chargers
- High-Efficiency Converters / Inverters
- Renewable Energy
- Smart-Grid / Grid-Tied Distributed Generation

System Benefits

- Enables Compact, Lightweight Systems
- Increased System Efficiency, due to Low Switching & Conduction Losses of SiC
- Reduced Thermal Requirements and System Cost

Maximum Parameters (Verified by Design)

Parameter	Symbol	Min.	Typ.	Max.	Unit	Test Conditions	Note
Drain-Source Voltage	V_{DS}			1700	V		
Gate-Source Voltage, Maximum Value	$V_{GS\ max}$	-8		+19		Transient, <100 ns	Fig. 33
Gate-Source Voltage, Recommended	$V_{GS\ op}$	-4		+15		Static	
DC Continuous Drain Current	I_D		653		A	$V_{GS} = 15\ V, T_c = 25\ ^\circ C, T_{VJ} \leq 175\ ^\circ C$	Fig. 20
			494			$V_{GS} = 15\ V, T_c = 90\ ^\circ C, T_{VJ} \leq 175\ ^\circ C$	
DC Source-Drain Current (Body Diode)	$I_{SD\ BD}$		446			$V_{GS} = -4\ V, T_c = 25\ ^\circ C, T_{VJ} \leq 175\ ^\circ C$	
			284			$V_{GS} = -4\ V, T_c = 90\ ^\circ C, T_{VJ} \leq 175\ ^\circ C$	
Pulsed Drain Current	$I_D\ (pulsed)$			1000		t_{pmax} limited by T_{VJmax} $V_{GS} = 15\ V, T_c = 25\ ^\circ C$	
Virtual Junction Temperature	$T_{VJ\ op}$	-40		175	$^\circ C$	Operation	



MOSFET Characteristics (Per Position) ($T_{VJ} = 25\text{ }^{\circ}\text{C}$ unless otherwise specified)

Parameter	Symbol	Min.	Typ.	Max.	Unit	Test Conditions	Note
Drain-Source Breakdown Voltage	$V_{(BR)DSS}$	1700				$V_{GS} = 0\text{ V}, T_{VJ} = -40\text{ }^{\circ}\text{C}$	
Gate Threshold Voltage	$V_{GS(th)}$	1.8	2.5	3.6	V	$V_{DS} = V_{GS}, I_D = 203\text{ mA}$	
			2.0			$V_{DS} = V_{GS}, I_D = 203\text{ mA}, T_{VJ} = 175\text{ }^{\circ}\text{C}$	
Zero Gate Voltage Drain Current	I_{DSS}		8	325	μA	$V_{GS} = 0\text{ V}, V_{DS} = 1700\text{ V}$	
Gate-Source Leakage Current	I_{GSS}		0.008	2		$V_{GS} = 15\text{ V}, V_{DS} = 0\text{ V}$	
Drain-Source On-State Resistance (Devices Only)	$R_{DS(on)}$		2.16	2.60	m Ω	$V_{GS} = 15\text{ V}, I_D = 500\text{ A}$	Fig. 2 Fig. 3
			4.97			$V_{GS} = 15\text{ V}, I_D = 500\text{ A}, T_{VJ} = 175\text{ }^{\circ}\text{C}$	
Transconductance	g_{fs}		369		S	$V_{DS} = 20\text{ V}, I_D = 500\text{ A}$	Fig. 4
			374			$V_{DS} = 20\text{ V}, I_D = 500\text{ A}, T_{VJ} = 175\text{ }^{\circ}\text{C}$	
Turn-On Switching Energy, $T_{VJ} = 25\text{ }^{\circ}\text{C}$ $T_{VJ} = 125\text{ }^{\circ}\text{C}$ $T_{VJ} = 175\text{ }^{\circ}\text{C}$	E_{On}		25.0 27.9 32.5		mJ	$V_{DD} = 900\text{ V}$ $I_D = 500\text{ A},$ $V_{GS} = -4\text{ V}/15\text{ V},$ $R_{G(OFF)} = 1.5\text{ }\Omega, R_{G(ON)} = 1.5\text{ }\Omega,$ $L = 14\text{ }\mu\text{H}$	Fig. 11 Fig. 13
Turn-Off Switching Energy, $T_{VJ} = 25\text{ }^{\circ}\text{C}$ $T_{VJ} = 125\text{ }^{\circ}\text{C}$ $T_{VJ} = 175\text{ }^{\circ}\text{C}$	E_{Off}		15.4 15.4 15.6				
Internal Gate Resistance	$R_{G(int)}$		0.93		Ω	$f = 1\text{ MHz}, V_{AC} = 25\text{ mV}$	
Input Capacitance	C_{iss}		64.9		nF	$V_{GS} = 0\text{ V}, V_{DS} = 1200\text{ V}$ $V_{AC} = 25\text{ mV}, f = 100\text{ kHz}$	Fig. 9
Output Capacitance	C_{oss}		1.5				
Reverse Transfer Capacitance	C_{rss}		42		pF		
Gate to Source Charge	Q_{GS}		640		nC	$V_{DS} = 1200\text{ V}, V_{GS} = -4\text{ V}/15\text{ V}$ $I_D = 735\text{ A}$ Per IEC60747-8-4 pg 21	
Gate to Drain Charge	Q_{GD}		560				
Total Gate Charge	Q_G		1992				
FET Thermal Resistance, Junction to Case	R_{thJC}		0.070		$^{\circ}\text{C}/\text{W}$		Fig. 17

Diode Characteristics (Per Position) ($T_{VJ} = 25\text{ }^{\circ}\text{C}$ unless otherwise specified)

Parameter	Symbol	Min.	Typ.	Max.	Unit	Test Conditions	Notes
Body Diode Forward Voltage	V_{SD}		5.5		V	$V_{GS} = -4\text{ V}, I_{SD} = 500\text{ A}$	Fig. 7
			4.8			$V_{GS} = -4\text{ V}, I_{SD} = 500\text{ A}, T_{VJ} = 175\text{ }^{\circ}\text{C}$	
Reverse Recovery Time	t_{RR}		67		ns	$V_{GS} = -4\text{ V}, I_{SD} = 500\text{ A}, V_R = 900\text{ V}$ $di/dt = 13\text{ A/ns}, T_{VJ} = 175\text{ }^{\circ}\text{C}$	Fig. 32
Reverse Recovery Charge	Q_{RR}		24		μC		
Peak Reverse Recovery Current	I_{RRM}		350		A		
Reverse Recovery Energy, $T_{VJ} = 25\text{ }^{\circ}\text{C}$ $T_{VJ} = 125\text{ }^{\circ}\text{C}$ $T_{VJ} = 175\text{ }^{\circ}\text{C}$	E_{RR}		0.6 3.3 6.3		mJ	$V_{DD} = 900\text{ V}, I_D = 500\text{ A},$ $V_{GS} = -4\text{ V}/15\text{ V}, R_{G(ON)} = 1.5\text{ }\Omega,$ $L = 14\text{ }\mu\text{H}$	Fig. 14



Module Physical Characteristics

Parameter	Symbol	Min.	Typ.	Max.	Unit	Test Conditions
Package Resistance, M1 (High-Side)	R ₁₋₂		106.5		μΩ	T _c = 125°C, Note 1
Package Resistance, M2 (Low-Side)	R ₂₋₃		126.3			T _c = 125°C, Note 1
Stray Inductance	L _{Stray}		4.9		nH	Between DC- and DC+, f = 10 MHz
Case Temperature	T _c	-40		125	°C	
Mounting Torque	M _s	3	4.5	5	N-m	Baseplate, M6 bolts
		0.9	1.1	1.3		Power Terminals, M4 bolts
Weight	W		167		g	
Case Isolation Voltage	V _{isol}	4			kV	AC, 50 Hz, 1 minute
Comparative Tracking Index	CTI	600				
Clearance Distance		13.07			mm	Terminal to Terminal
		6.00				Terminal to Heatsink
Creepage Distance		14.27				Terminal to Terminal
		12.34				Terminal to Heatsink

Note:

¹Total Effective Resistance (Per Switch Position) = MOSFET R_{DS(on)} + Switch Position Package Resistance

NTC Characteristics (T_{NTC} = 25 °C unless otherwise specified)

Parameter	Symbol	Min.	Typ.	Max.	Unit	Notes
Resistance at 25°C	R ₂₅		4700		Ω	
Tolerance of R ₂₅			±1		%	
Beta Value for 25°C to 85°C	B _{25/85}		3435		K	
Beta Value for 0°C to 100°C	B _{0/100}		3399		K	
Tolerance of B _{25/85}			±1		%	
Maximum Power Dissipation	P _{Max}		50		mW	

Steinhart & Hart Coefficients for NTC Resistance & NTC Temperature Computation (T in K)

$$\ln\left(\frac{R}{R_{25}}\right) = A + \frac{B}{T} + \frac{C}{T^2} + \frac{D}{T^3}$$

$$\frac{1}{T} = A_1 + B_1 \ln\left(\frac{R}{R_{25}}\right) + C_1 \ln^2\left(\frac{R}{R_{25}}\right) + D_1 \ln^3\left(\frac{R}{R_{25}}\right)$$

A	B	C	D
-1.289E+01	4.245E+03	-8.749E+04	-9.588E+06

A ₁	B ₁	C ₁	D ₁
3.354E-03	3.001E-04	5.085E-06	2.188E-07



Typical Performance

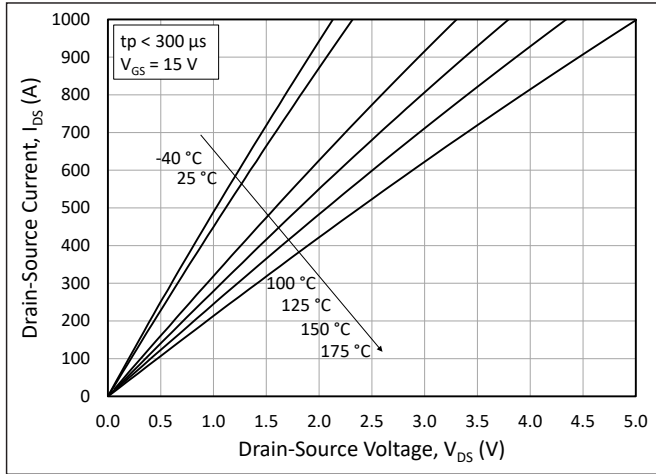

Figure 1. Output Characteristics for Various Junction Temperatures

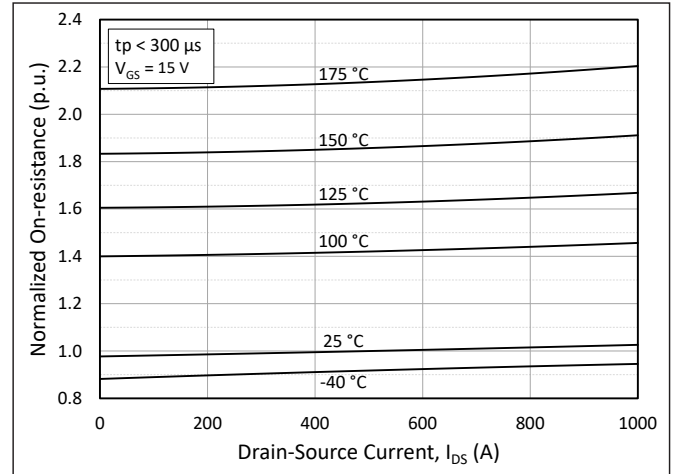

Figure 2. Normalized On-State Resistance vs. Drain Current for Various Junction Temperatures

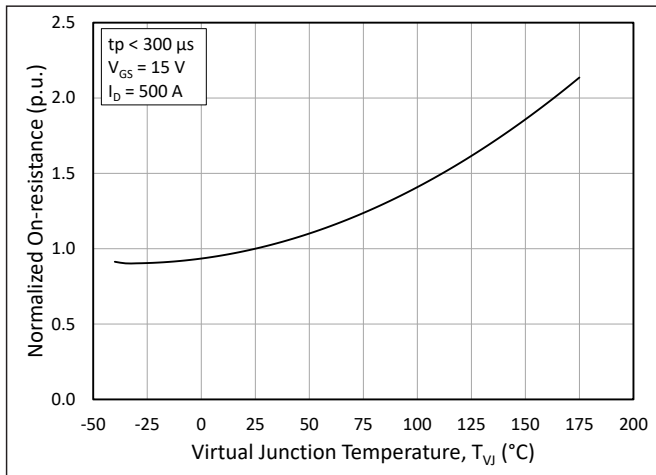

Figure 3. Normalized On-State Resistance vs. Junction Temperature

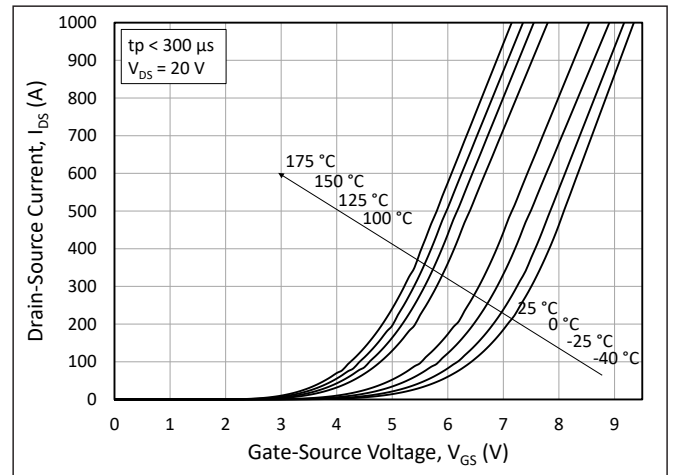

Figure 4. Transfer Characteristic for Various Junction Temperatures

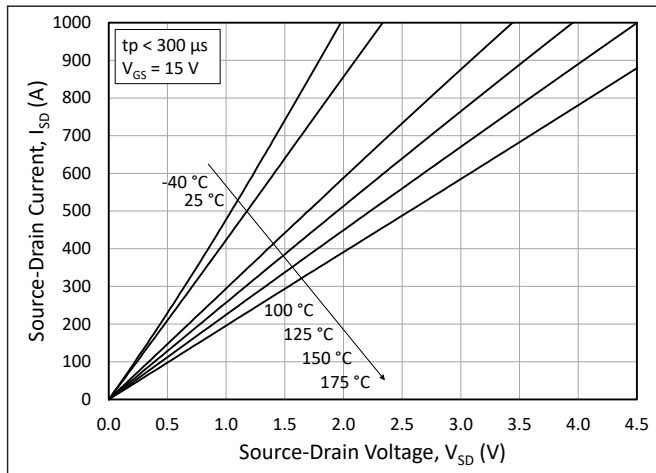

Figure 5. 3rd Quadrant Characteristic vs. Junction Temperatures at $V_{GS} = 15\text{ V}$

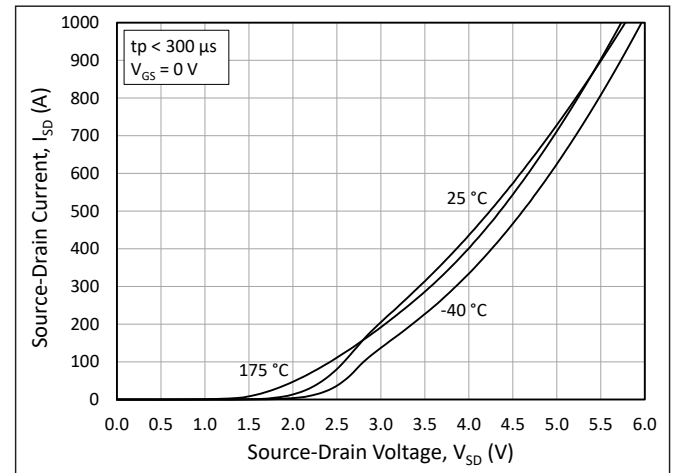

Figure 6. 3rd Quadrant Characteristic vs. Junction Temperatures at $V_{GS} = 0\text{ V}$ (Body Diode)



Typical Performance

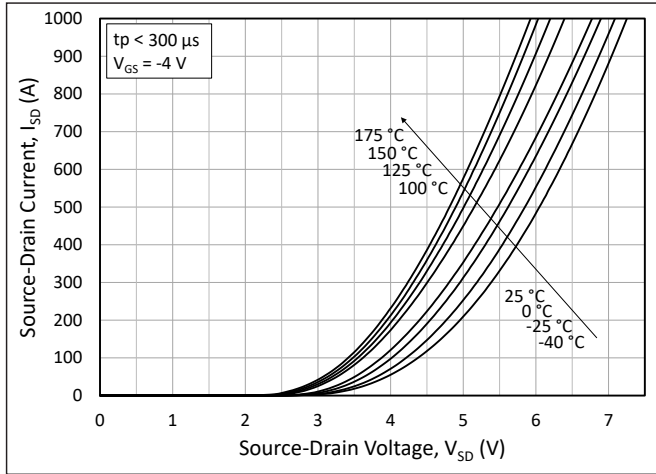

Figure 7. 3rd Quadrant Characteristic vs. Junction Temperatures at $V_{GS} = -4$ V (Body Diode)

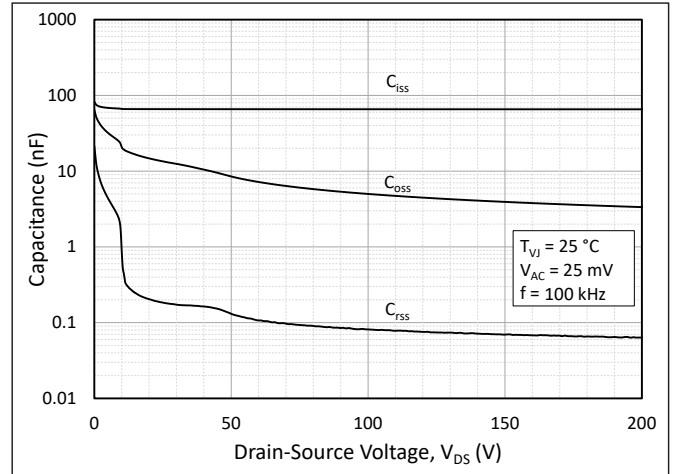

Figure 8. Typical Capacitances vs. Drain to Source Voltage (0 - 200V)

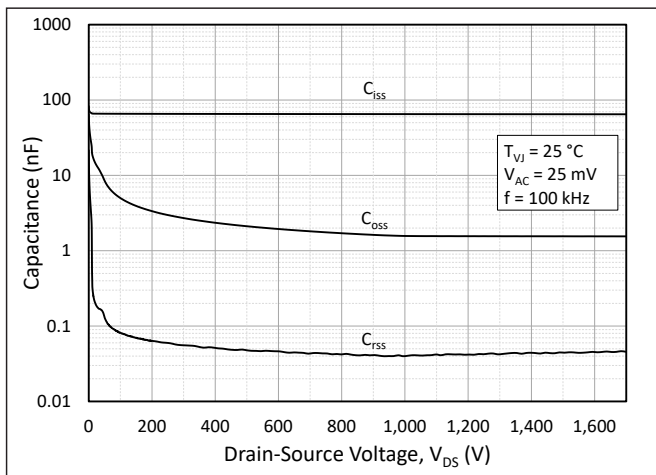

Figure 9. Typical Capacitances vs. Drain to Source Voltage (0 - 1200V)

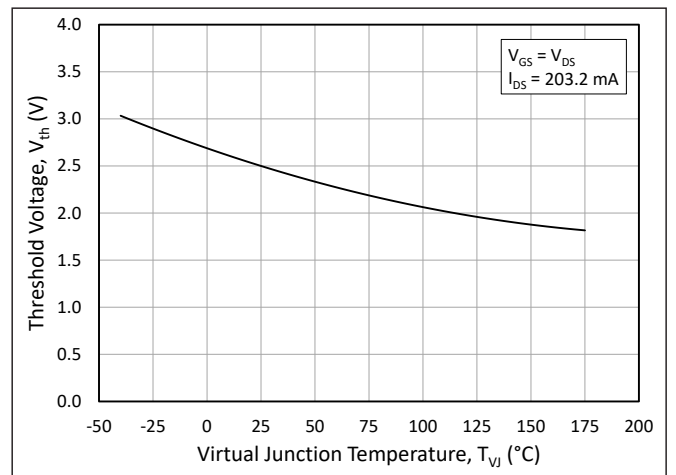

Figure 10. Threshold Voltage vs. Junction Temperature

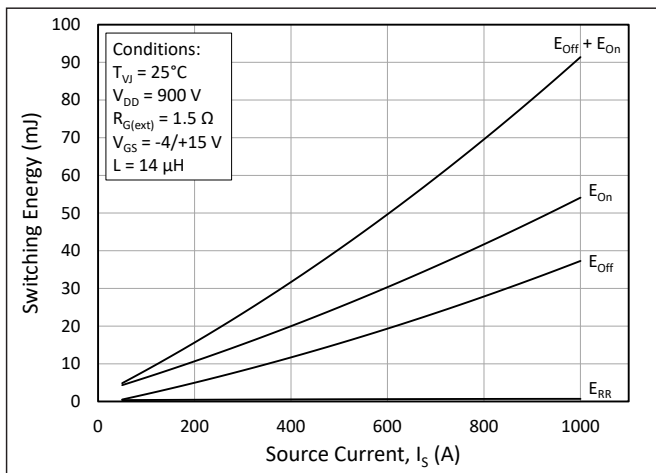

Figure 11. Switching Energy vs. Drain Current ($V_{DD} = 900$ V)

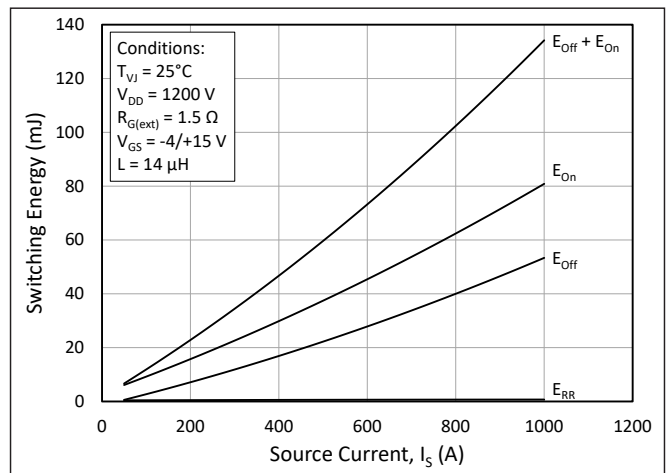

Figure 12. Switching Energy vs. Drain Current ($V_{DD} = 1200$ V)

Typical Performance

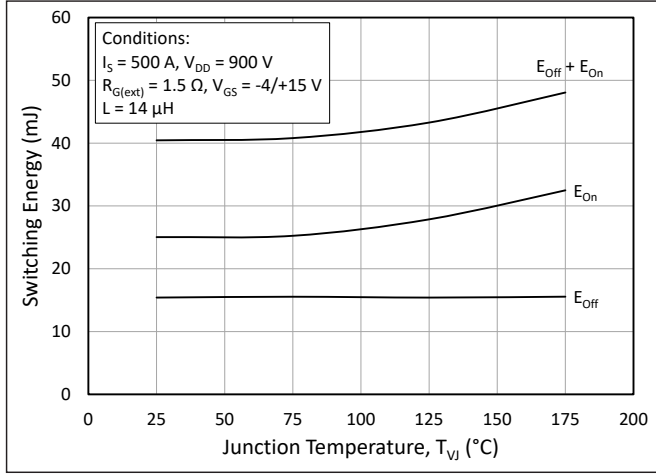

Figure 13. MOSFET Switching Energy vs. Junction Temperature

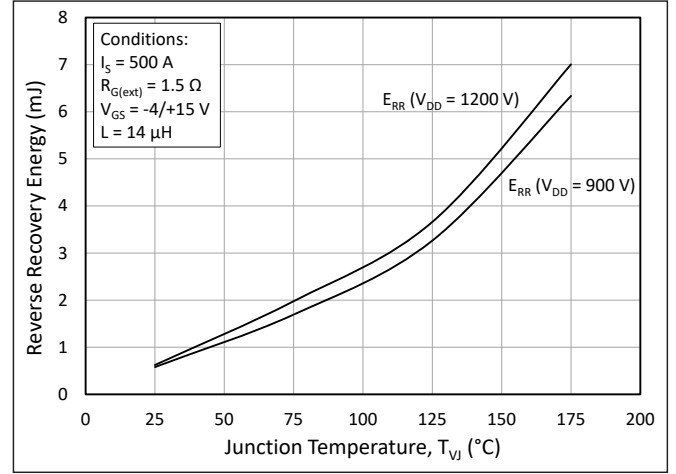

Figure 14. Reverse Recovery Energy vs. Junction Temperature

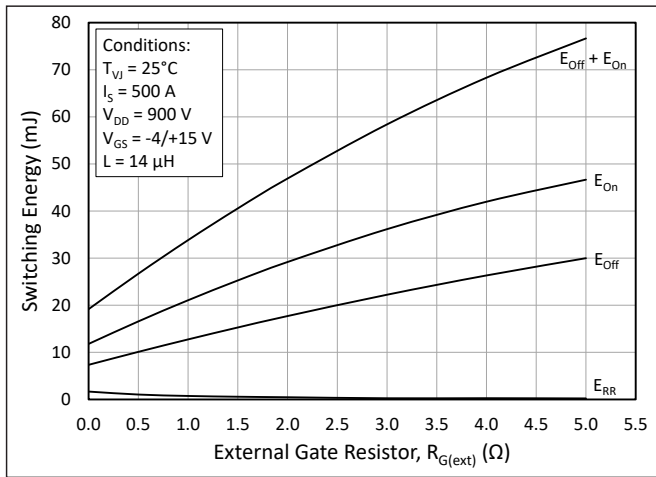

Figure 15. MOSFET Switching Energy vs. External Gate Resistance

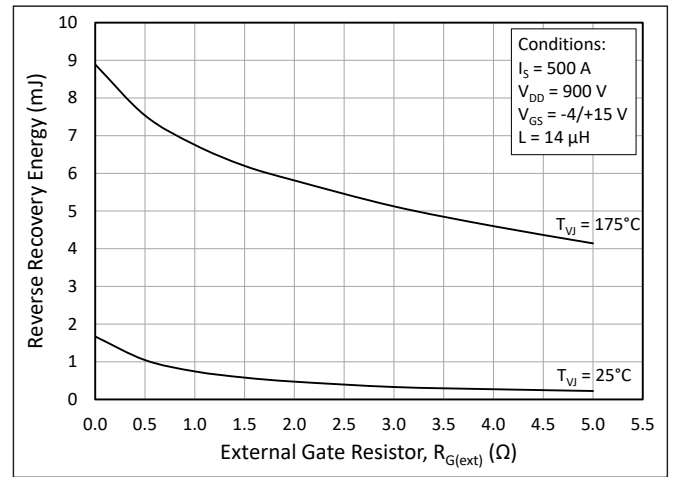

Figure 16. Reverse Recovery Energy vs. External Gate Resistance

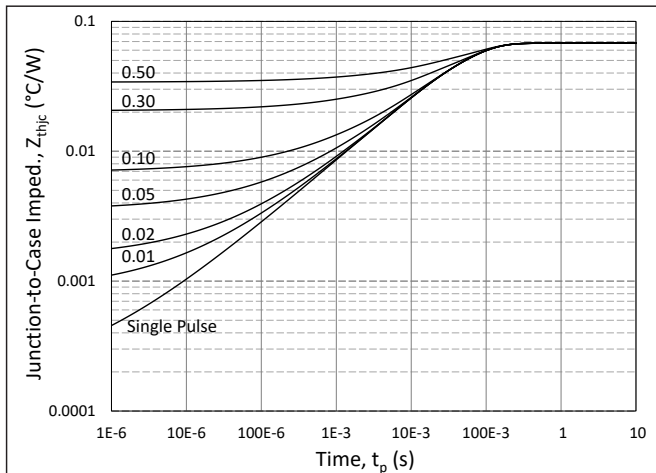

Figure 17. MOSFET Junction to Case Transient Thermal Impedance, Z_{thJC} (°C/W)

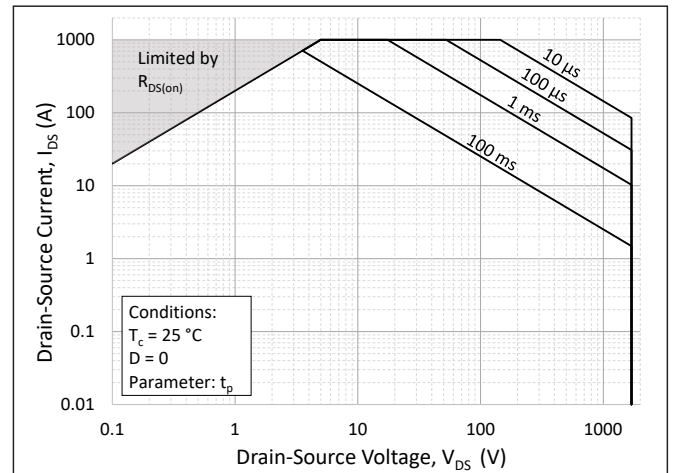

Figure 18. Forward Bias Safe Operating Area (FBSOA)



Typical Performance

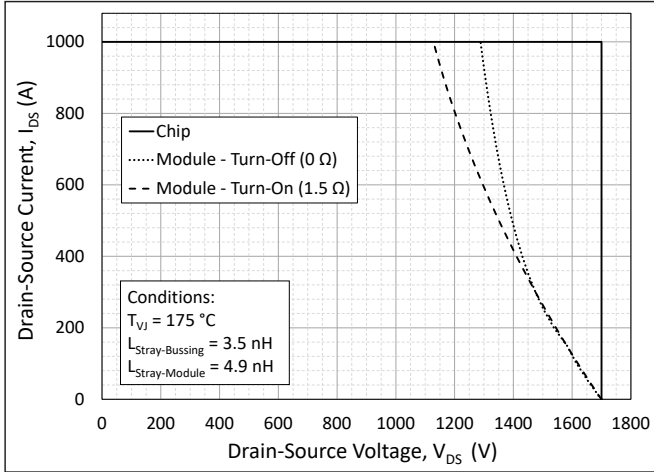

Figure 19. Reverse Bias Safe Operating Area (RBSOA)

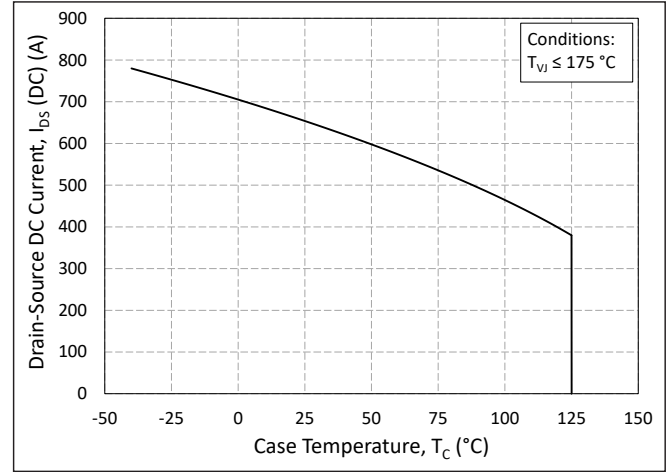

Figure 20. Continuous Drain Current Derating vs. Case Temperature

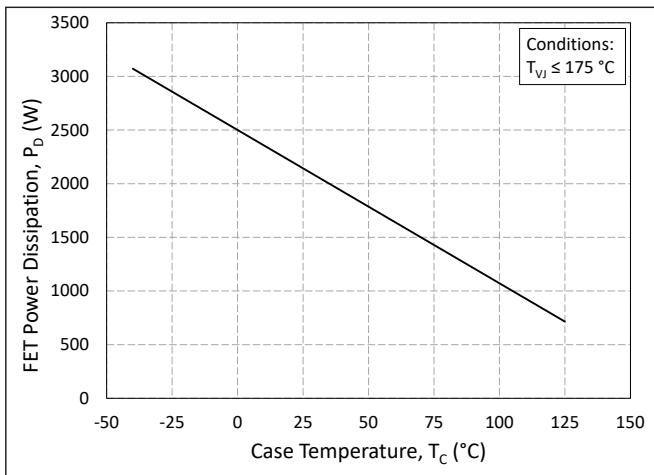

Figure 21. Maximum Power Dissipation Derating vs. Case Temperature

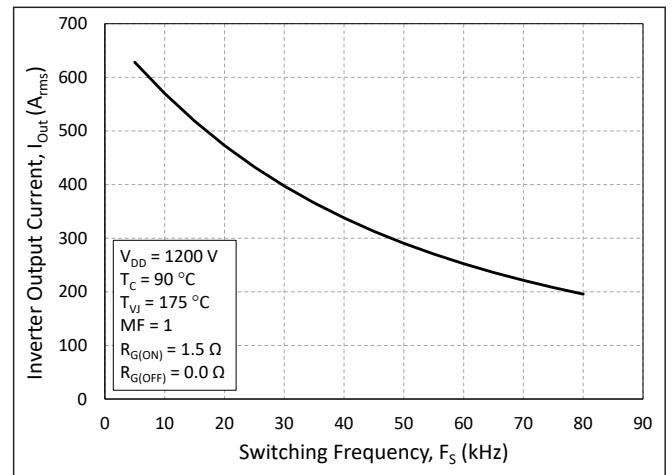

Figure 22. Typical Output Current Capability vs. Switching Frequency (Inverter Application)

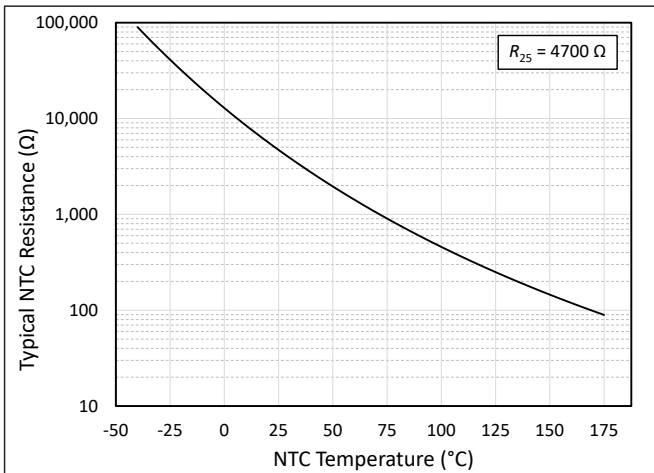

Figure 23. NTC Resistance vs. NTC Temperature



Timing Characteristics

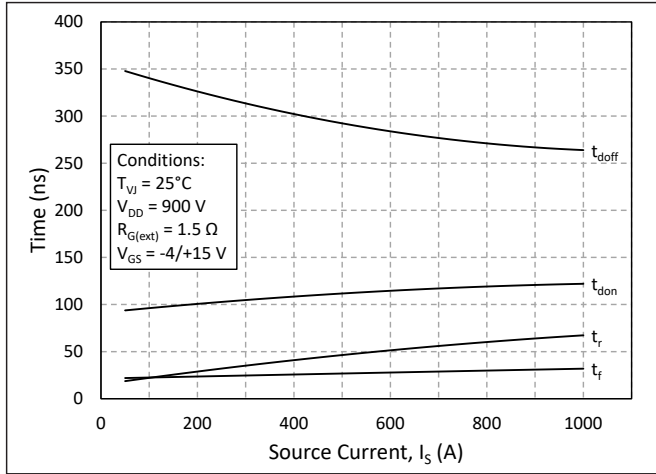

Figure 24. Timing vs. Source Current

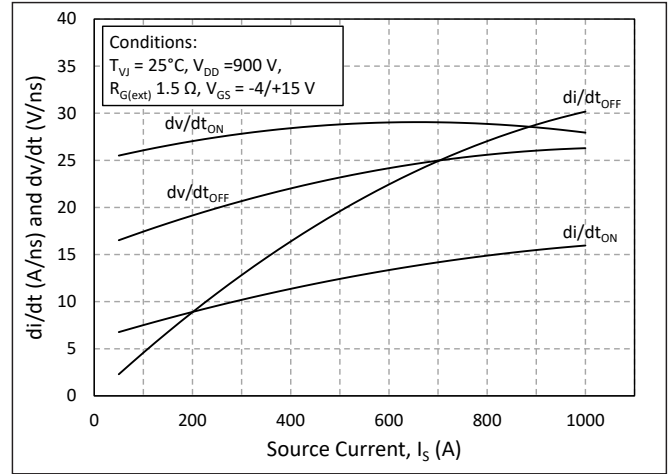

Figure 25. dv/dt and di/dt vs. Source Current

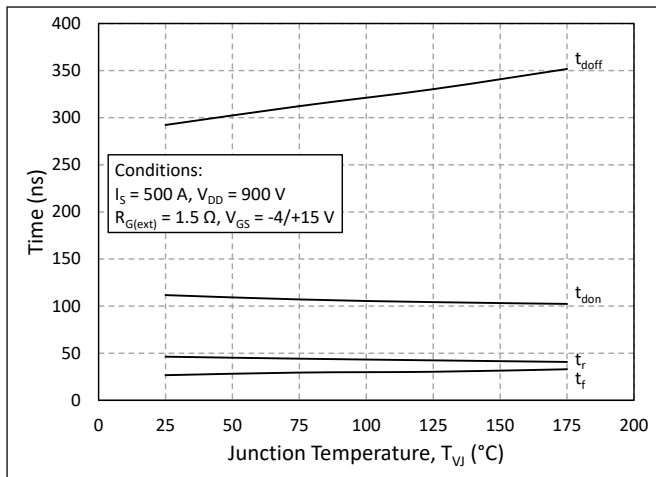

Figure 26. Timing vs. Junction Temperature

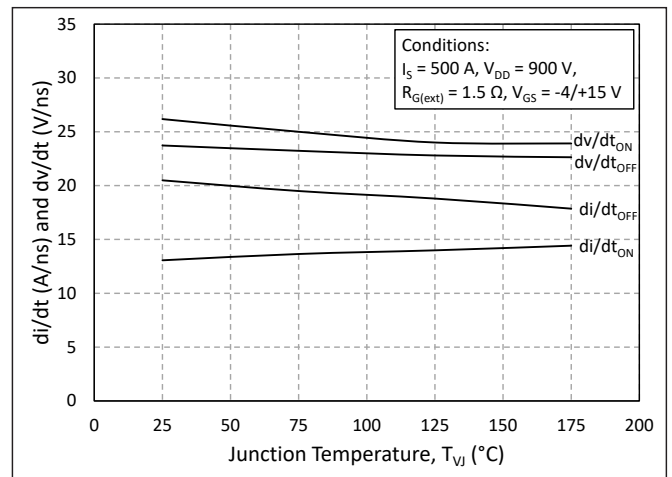

Figure 27. dv/dt and di/dt vs. Junction Temperature

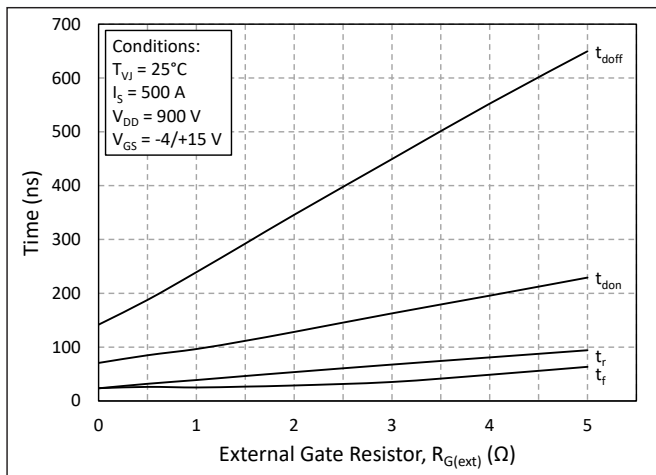

Figure 28. Timing vs. External Gate Resistance

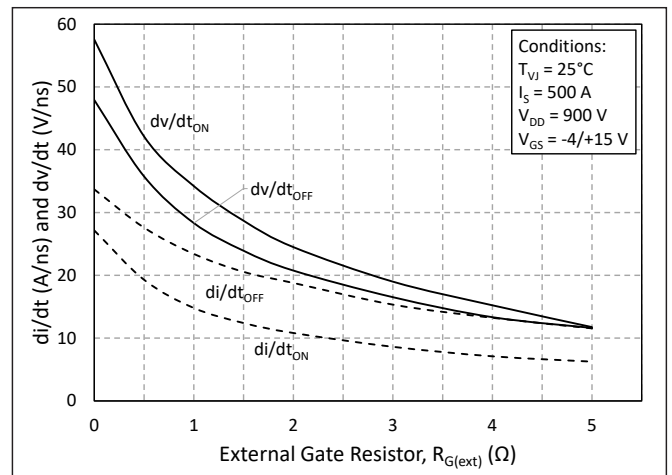

Figure 29. dv/dt and di/dt vs. External Gate Resistance



Definitions

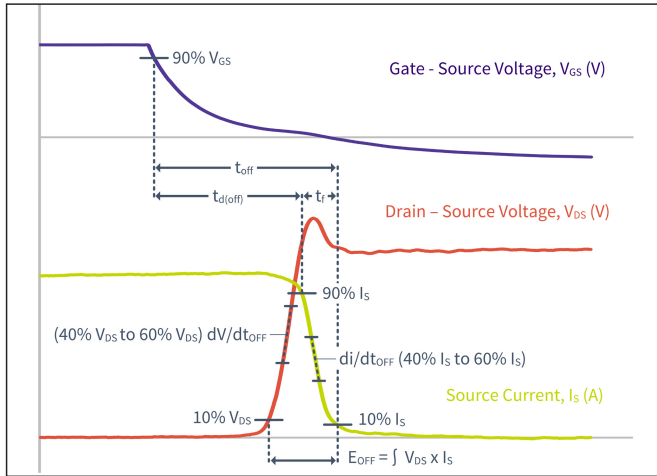

Figure 30. Turn-off Transient Definitions

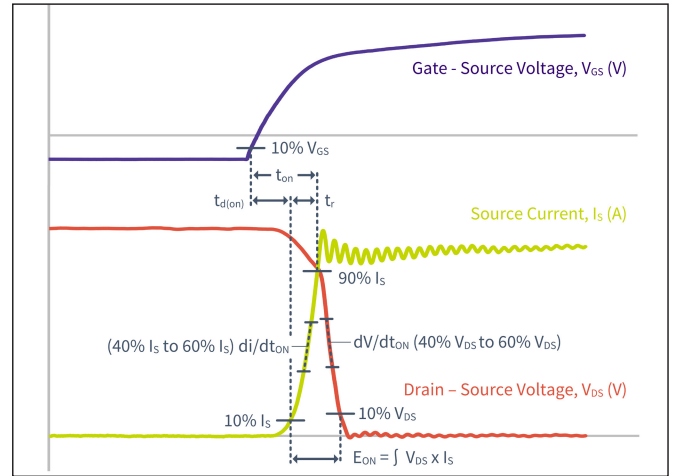

Figure 31. Turn-on Transient Definitions

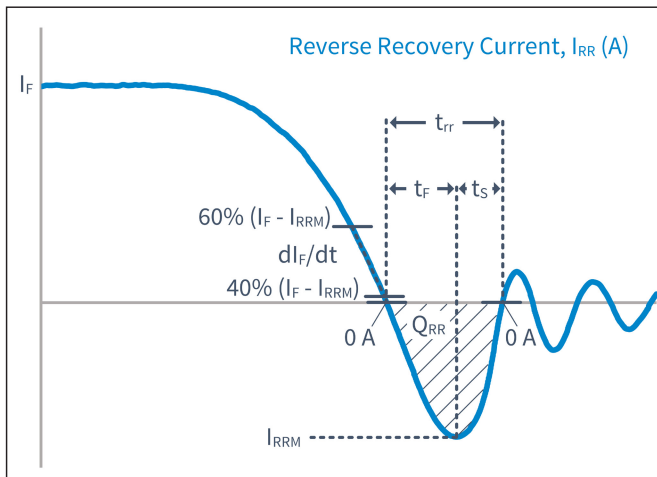

Figure 32. Reverse Recovery Definitions

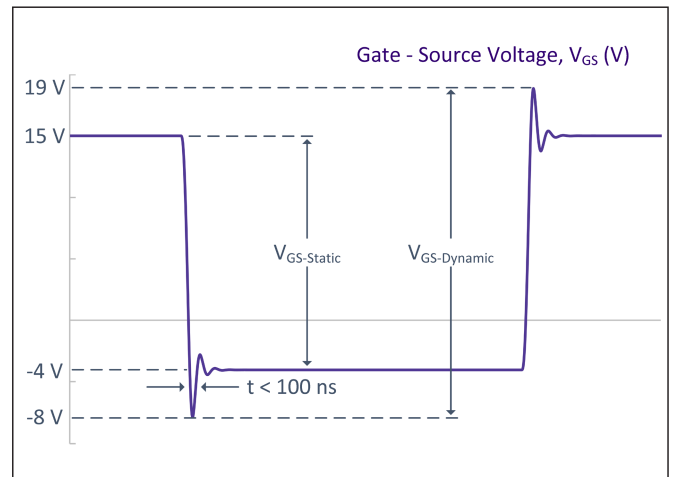
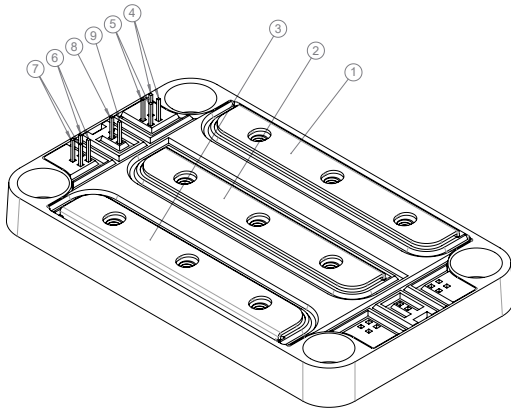

Figure 33. V_{GS} Transient Definitions



Schematic and Pin Out



PIN OUT SCHEME	
PIN	LABEL
①	V+
②	Mid
③	V-
④	G1, Top row pins (2)
⑤	K1, Bottom row pins (2)
⑥	G2, Top row pins (2)
⑦	K2, Bottom row pins (2)
⑧	NTC1
⑨	NTC2

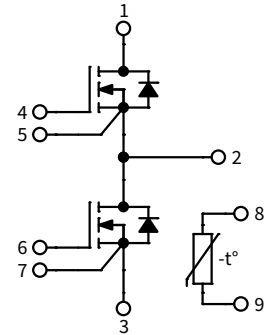

Package Dimension (mm)

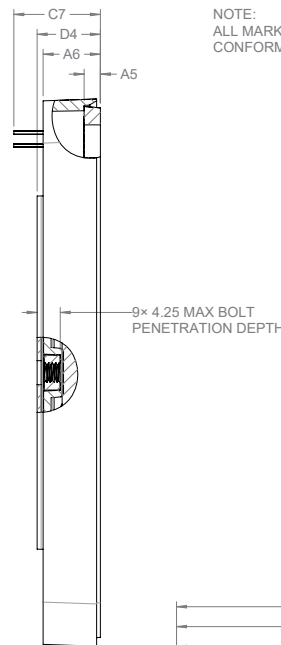
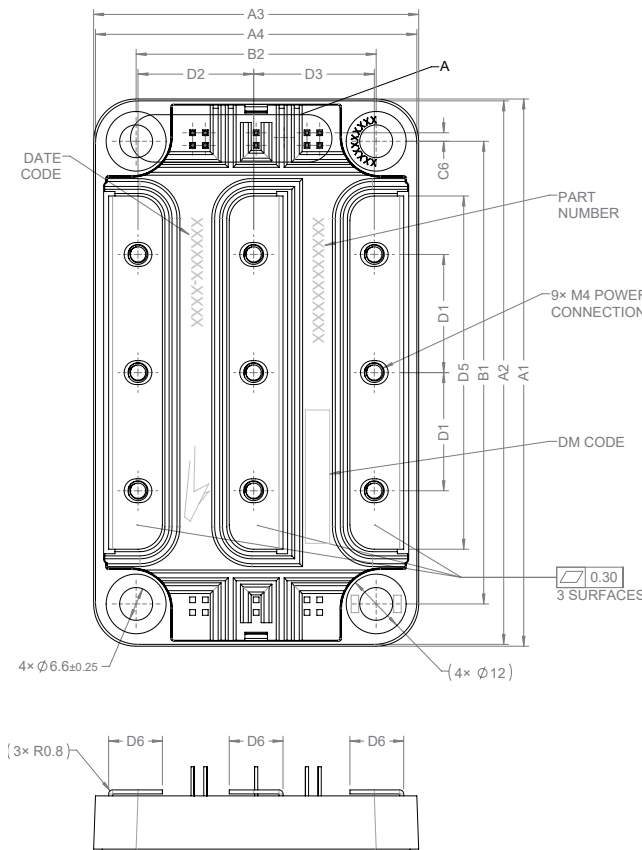

NOTE:
ALL MARKINGS SHALL
CONFORM TO PRC-00786.

DIMENSION TABLE		
SYMBOL	DIMENSION	TOLERANCE
A1	110.00	±0.60
A2	109.25	±0.60
A3	65.00	±0.60
A4	64.25	±0.60
A5	3.25	±0.30
A6	11.45	±0.60
B1	93.00	±0.30
B2	48.00	±0.30
C1	11.30	±0.40
C2	13.84	±0.40
C3	24.00	±0.40
C4	34.16	±0.40
C5	36.70	±0.40
C6	1.71	±0.40
C7	17.30	±0.50
C8	2.54	±0.30
C9	0.64	±0.30
C10	10.16	±0.40
D1	23.75	±0.50
D2	23.13	±0.50
D3	24.13	±0.50
D4	12.20	±0.50
D5	71.00	±0.30
D6	10.75	±0.30

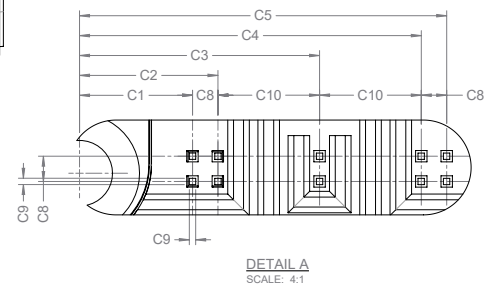



Supporting Links & Tools

Evaluation Tools & Support

- [CAB500M17HM3 PLECS Model](#)
- [SpeedFit 2.0 Design Simulator™](#)
- [Technical Support Forum](#)
- [Dynamic Characterization Evaluation Tool for the High Performance 62mm \(HM\) Module Platform](#)

Dual-Channel Gate Driver Board

- [CGD1700HB3P-HM3: Wolfspeed Gate Driver Board](#)
- [CGD12HB00D: Differential Transceiver Daughter Board Companion Tool for Differential Gate Drivers](#)

Application Notes

- [CPWR-AN35: 62mm Thermal Interface Material Application Note](#)
- [CPWR-AN39: KIT-CRD-CIL12N-HM User Guide](#)
- [PRD-04814: Design Options for Wolfspeed® Silicon Carbide MOSFET Gate Bias Power Supplies](#)