

SPECIFICATION

- Part No. : **CBD01.07.0100C**
- Product Name : 2.4GHz Cable Dipole Antenna
- Feature : 2.4GHz Wi-Fi/ISM band Antenna
Lightweight (1.47g) and Thin for UAV Applications
Flexible for easy integration
High Efficiency >70%
3dBi Peak Gain
Omnidirectional
Linear Polarization
100mm Ø1.37 Micro-Coaxial Cable
with IPEX MHF1 (U.FL) Connector
Cable and Connector Customizable
RoHS Compliant



1. Introduction

The CBD01 2.4GHz antenna is a micro coax cable dipole antenna with omnidirectional radiation pattern which has a high efficiency of over 70% at 2.4GHz. These attributes make it ideal for use on 2.4GHz UAV applications for FPV (First-Person View) and contribute to a more reliable link. The CBD01 antenna comes in a small form factor which is very lightweight and easy to attach. The standard product comes with 100mm low loss 1.37mm coaxial cable and IPEX MHFI (U.FL) connector.

The cable routes conveniently directly out of the bottom of the antenna, reducing the volume the antenna takes up in the device to an absolute minimum compared to other designs. The cable dipole antenna is the ideal antenna solution for fitting into narrow spaces and still maintaining high performance.

Due to the potential for detuning or nearby interference in a device environment, Taoglas recommends that you contact us at our regional sales office for integration support, testing, and optimization of the antenna in your device before going to production. Customized cable and connector versions available, subject to minimum order quantities.

2. Specification Table

ELECTRICAL	
Operation Frequency (MHz)	2400-2500MHz
Polarization	Linear
Impedance	50Ω
Max VSWR	2:1
Max Return Loss (dB)	<-10
Peak Gain (dBi)	3.24
Efficiency (%)	71.72%
Average Gain (dBi)	-1.45
Radiation Properties	Omnidirectional
Max Input Power	2 W
MECHANICAL	
Dimensions	57mm (Maximum diameter:4.7mm)
Cable Type	Ø1.37mm coaxial cable
Cable Length	100mm
Connector	IPEX MHFHT
Housing Material	PE Heat Shrink
Weight	1.47g
ENVIRONMENTAL	
Operating Temperature	-40°C to +85°C
Storage Temperature	-40°C to +85°C
Relative Humidity	40% to 95%
RoHs Compliant	Yes

* Tested in free space

3. Antenna Characteristics

3.1. Return Loss (Free Space)

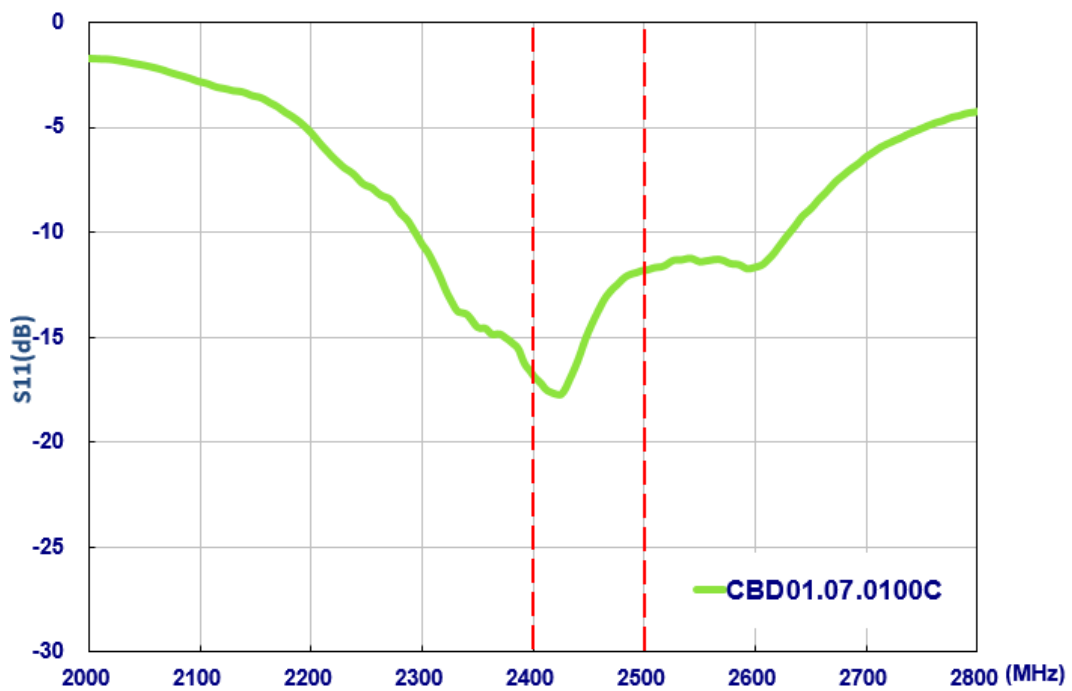

3.2. Efficiency (Free Space)

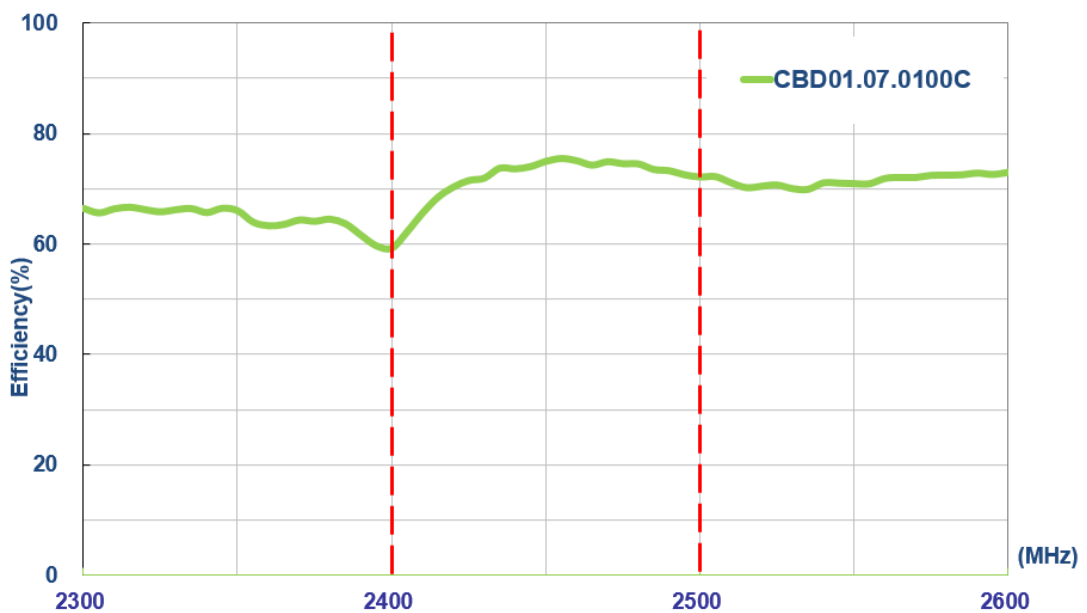

3.3. Peak Gain (Free Space)

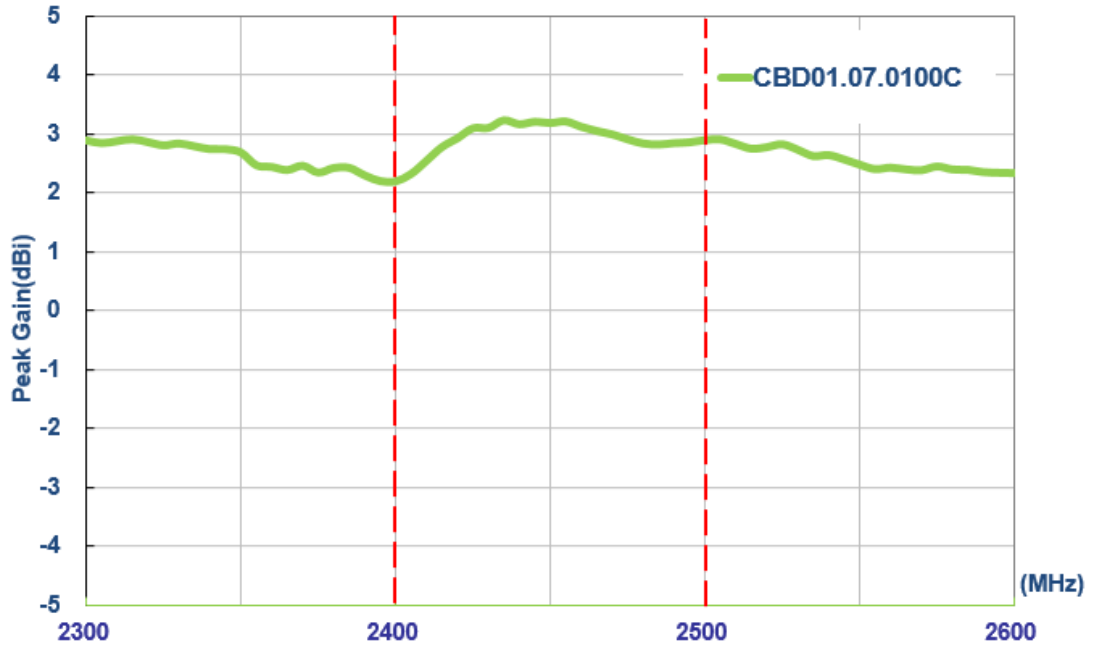

3.4. Average Gain (Free Space)

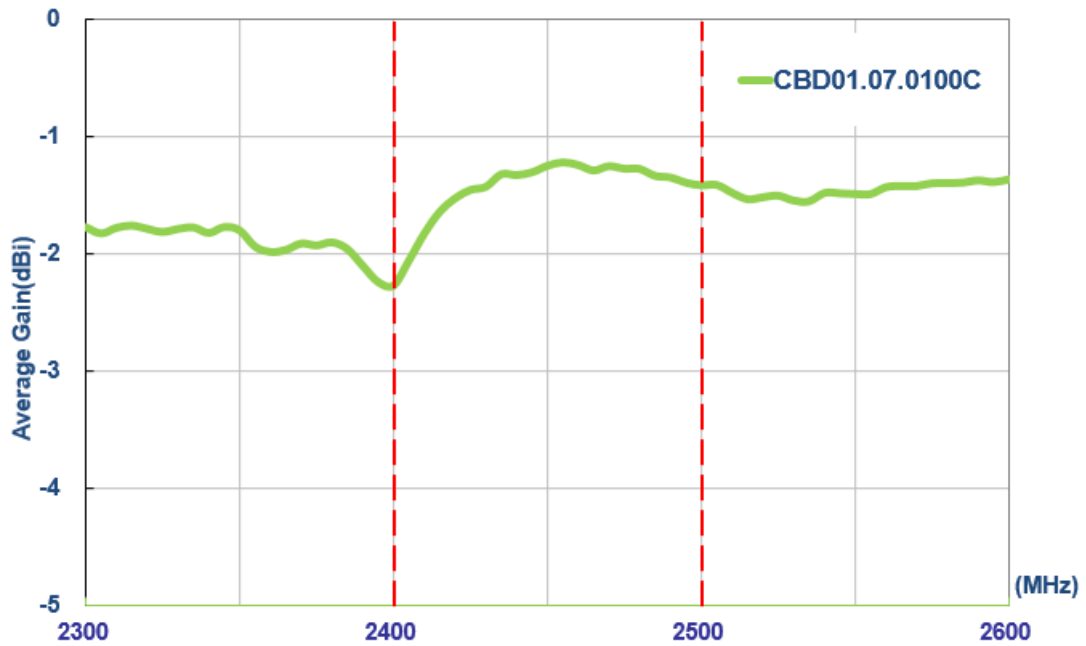

3.5. Testing Setup

The antenna was measured in a CTIA certified ETS-Lindgren Anechoic Chamber.

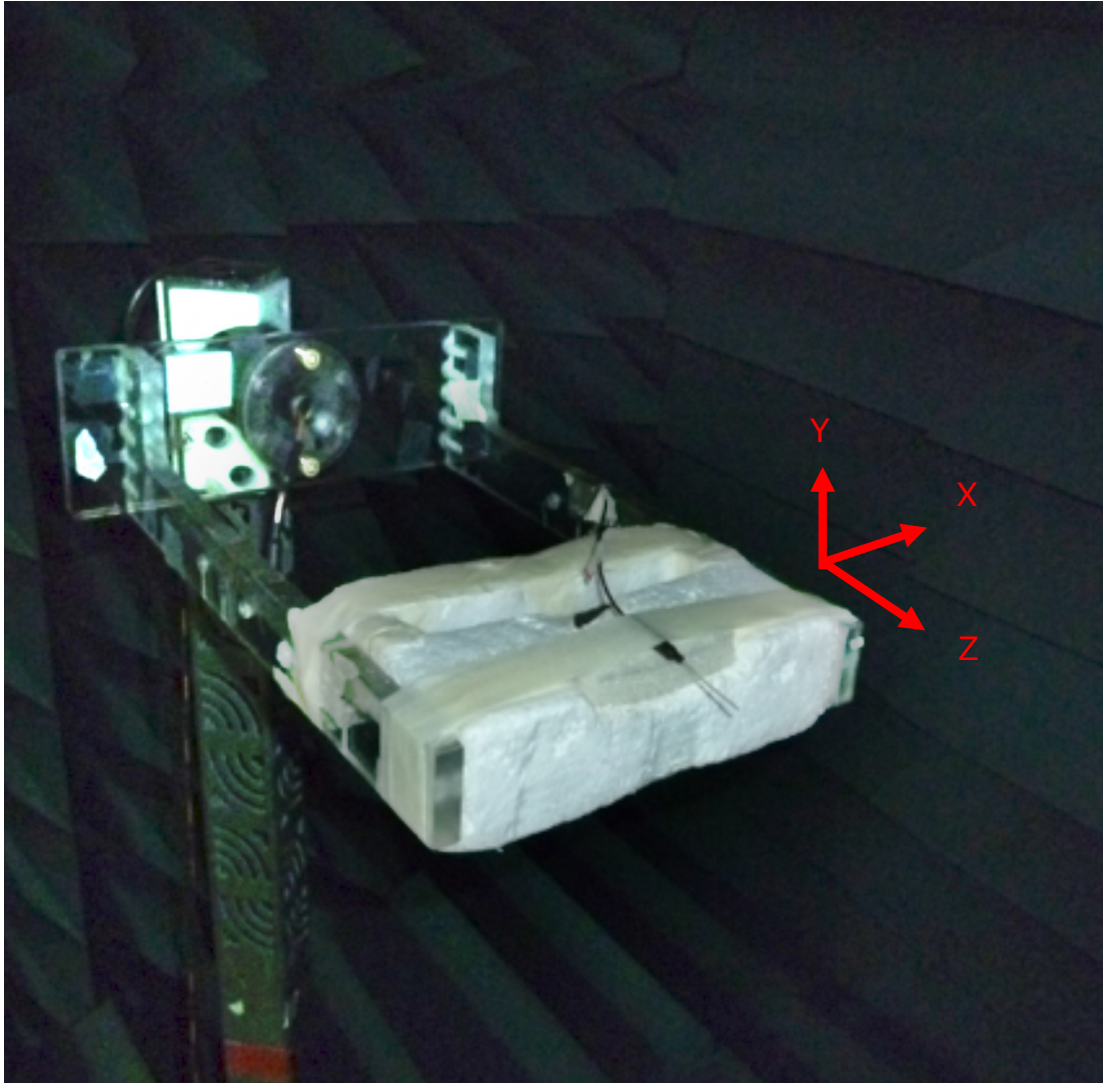

3.6. 3D Radiation Pattern

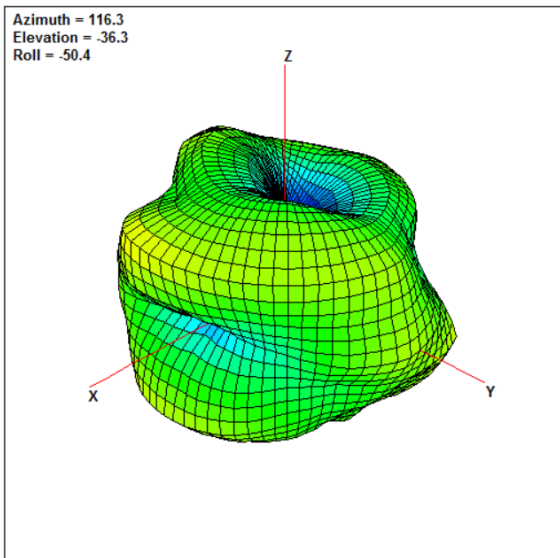

2400MHz

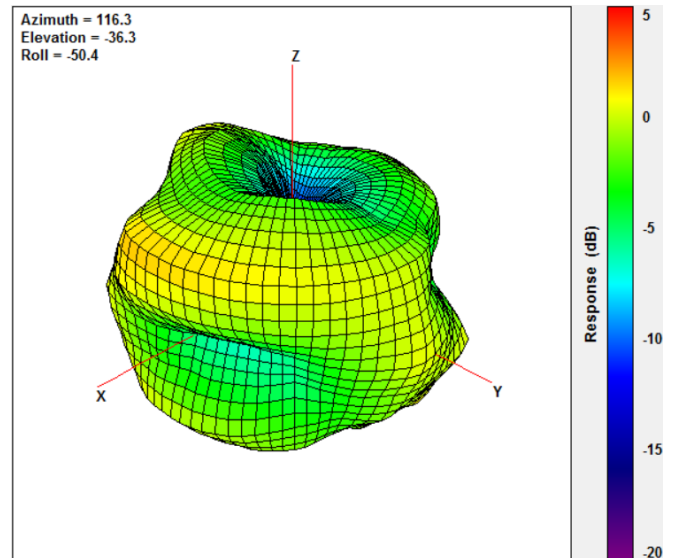

2450MHz

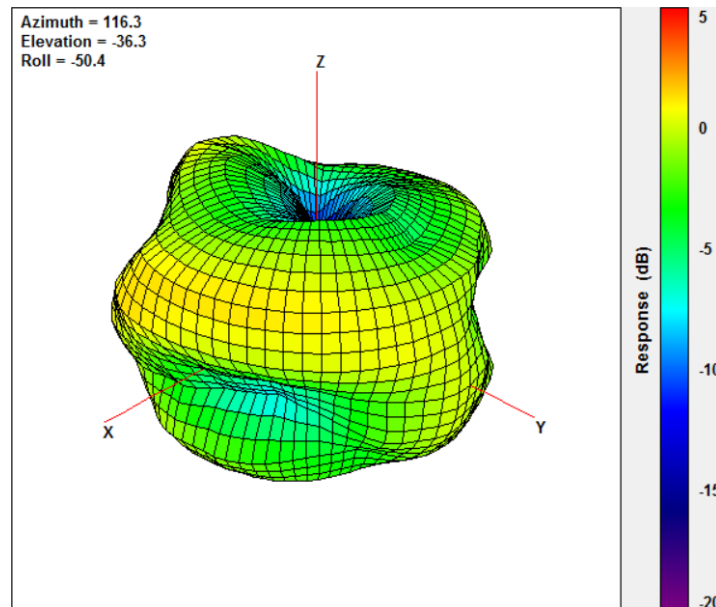

2500MHz

3.7. 2D Radiation Pattern

XY Plane

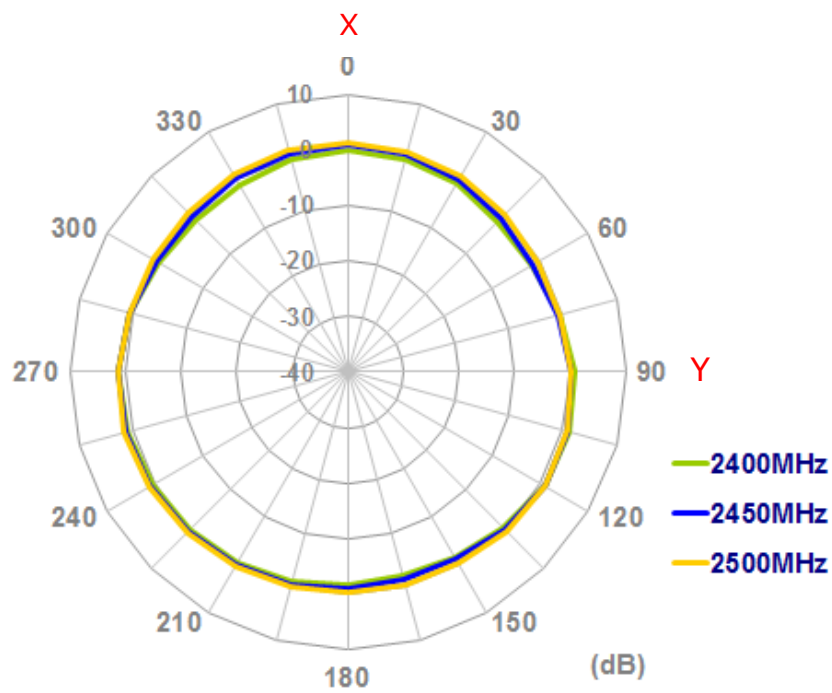

XZ Plane

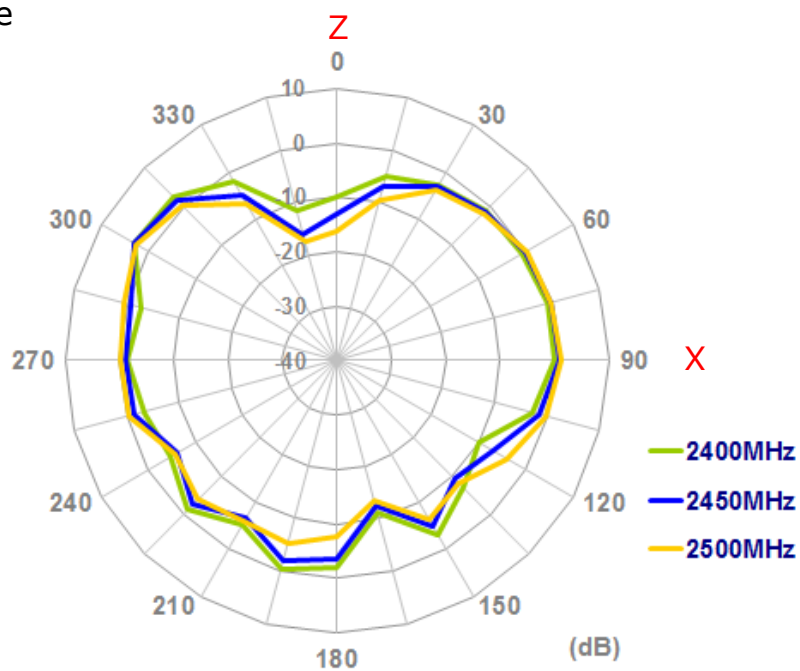

YZ Plane

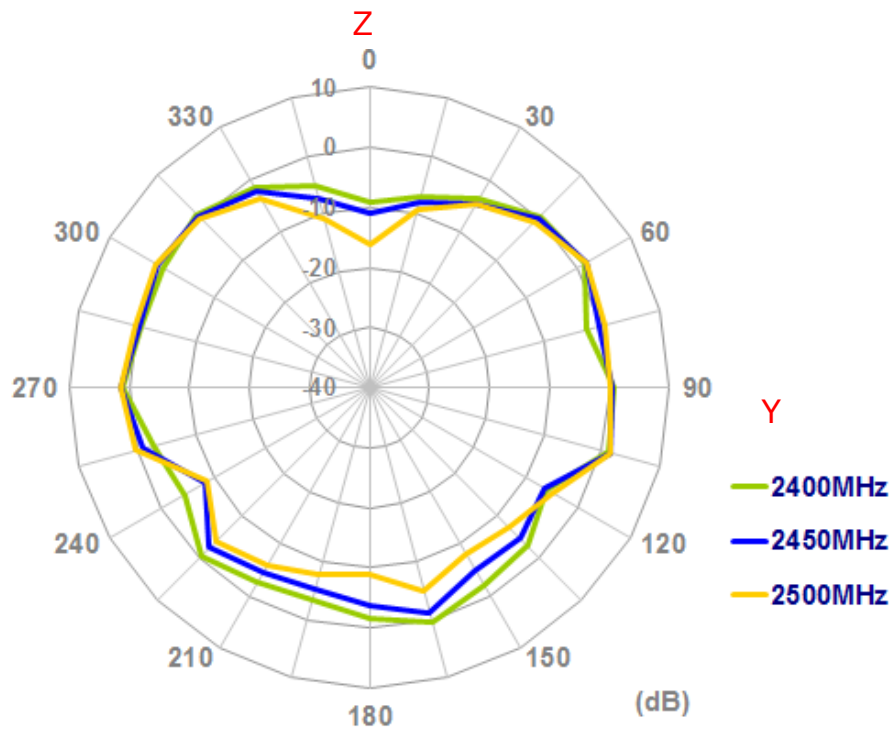

4. Drawing (Unit: mm)

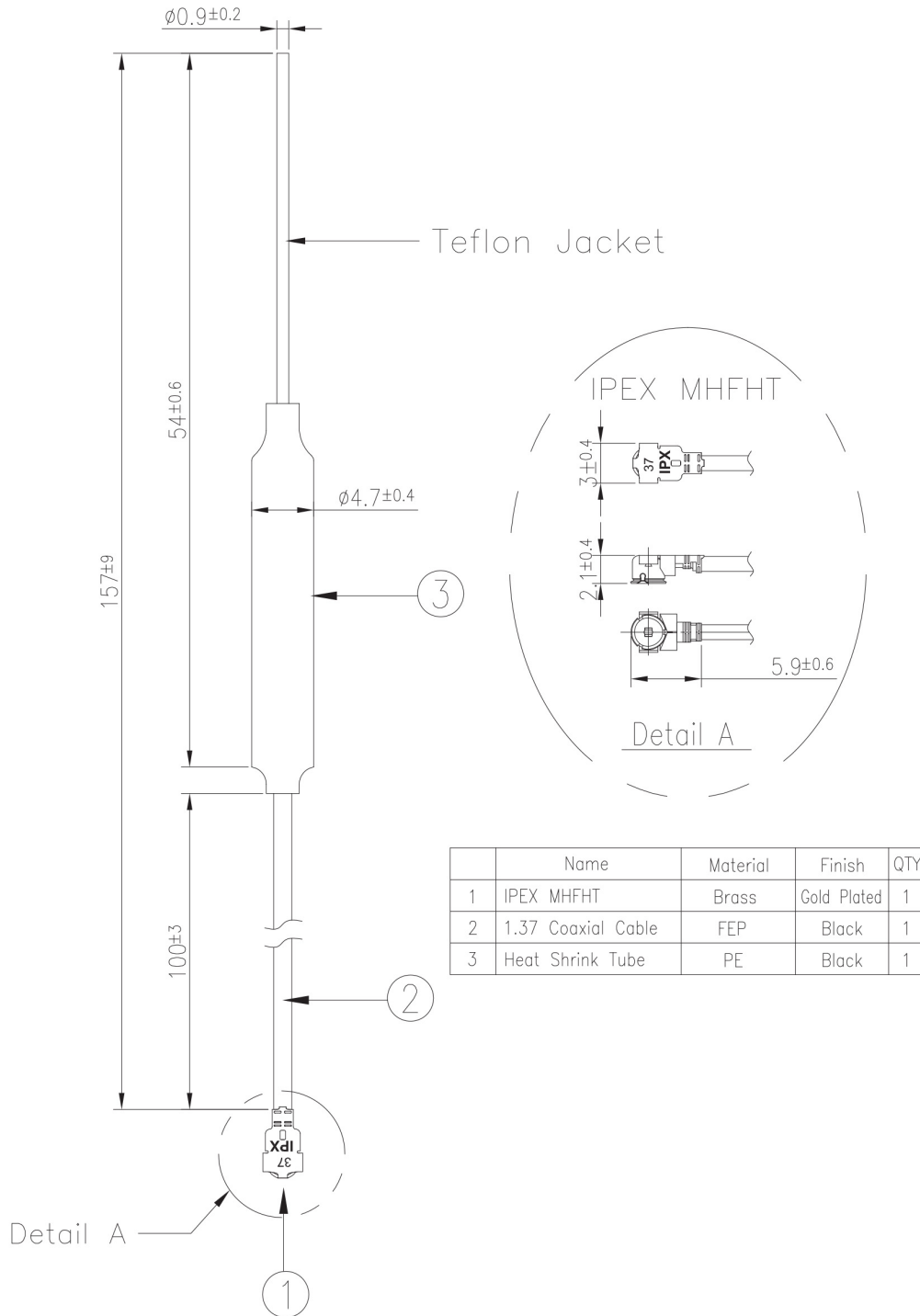

5. Packaging

100 pcs CBD01.07.0100C per PE Bag
 PE Bag Dimensions - 220*130mm
 Weight - 135g

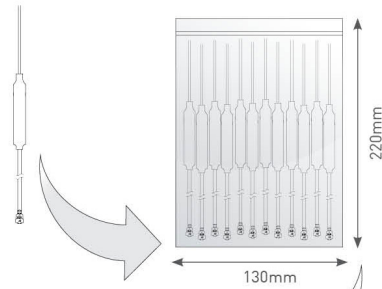

10 PE Bags per Large PE Bag
 1000 pcs CBD01.07.0100C per Large PE Bag
 Large PE Bag Dimensions - 466*380mm
 Weight - 1.35kg

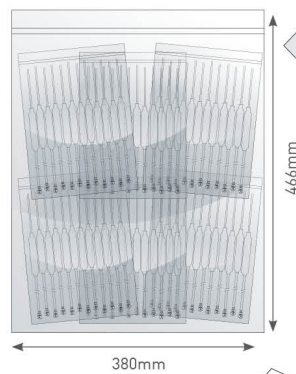

350 Large PE Bags per carton
 3500 pcs CBD01.07.0100C per carton
 Carton Dimensions - 360*310*170mm
 Weight - 5kg

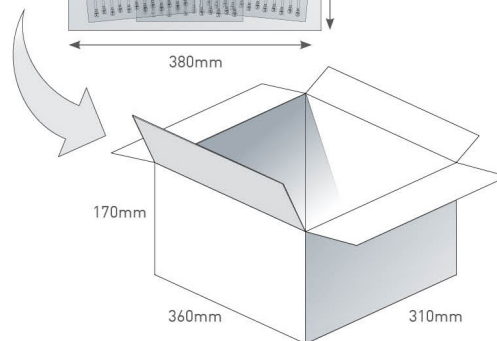

Pallet Dimensions 1080mm*930mm*1340mm
 63 Cartons per Pallet
 9 Cartons per layer
 7 Layers

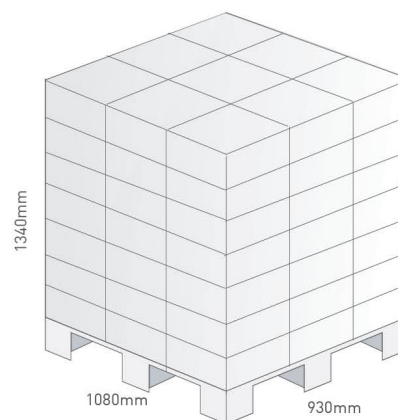

6. Installation

2.4GHz remote control receivers usually need two separate 2.4GHz receiver antennas for receive diversity.

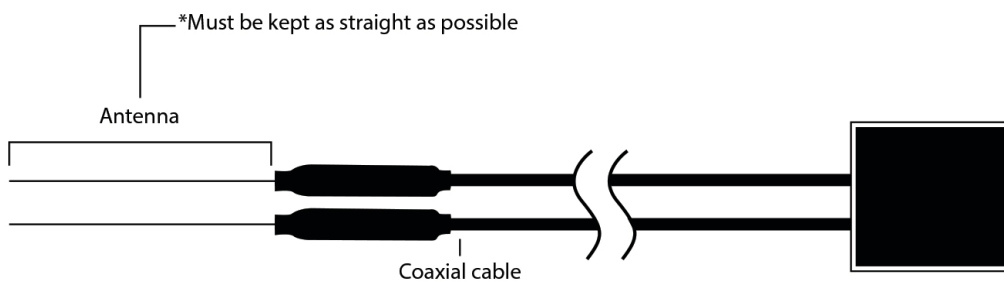

* 2.4GHz remote control receivers + 2.4GHz receiver antennas

The user connects the two CBD.01 antennas to a 2.4GHz remote control receiver. The two antennas should be placed at 90 degrees to each other. They should be kept as straight as possible but also kept away from each other as much as possible. If not, effective range could be reduced.

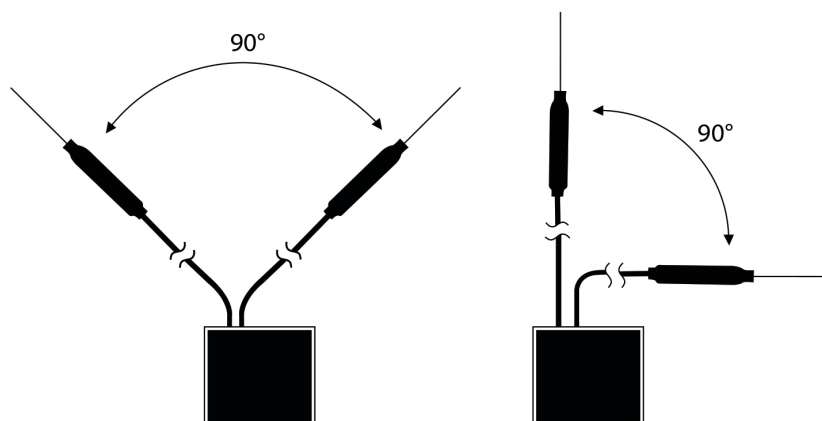

Our antennas should be placed at both sides of the 2.4G remote receiver. Then the best RF signal condition can be obtained at any flying attitude. The antennas must be kept 15mm away from metal materials.

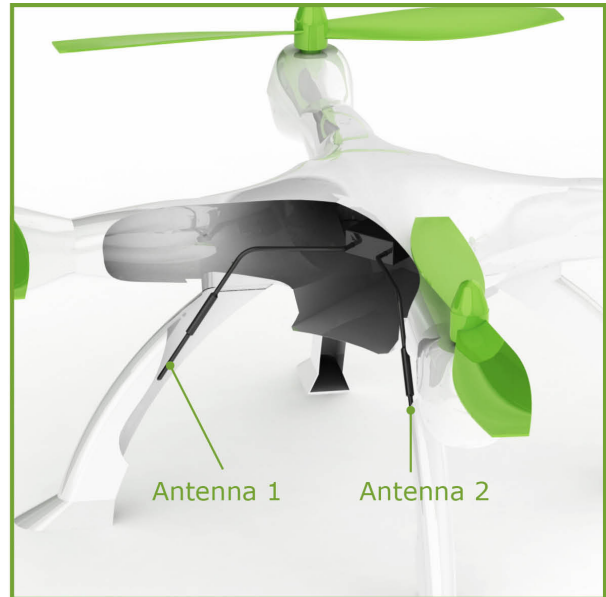
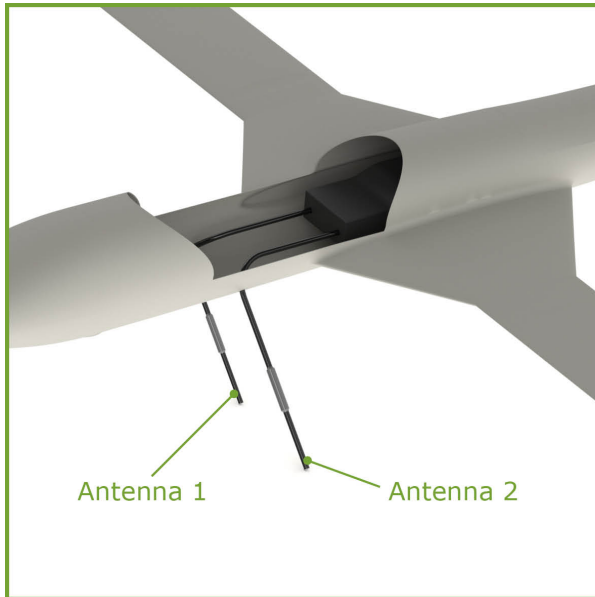

Cable ties or adhesive can be used on the bottom of the filter jacket for the most reliable mounting solution. Ideally, the antenna is mounted close to the outer edge of the UAV device to allow it to radiate outwards and receive signals without obstruction from internal components in the device.

In order to have best maximum antenna efficiency, it is suggested that the antenna is installed on plastic or fiberglass surfaces. Also it is important to keep the antennas away from the motor, ESC, and other electrical noise sources to reduce interference entering the receiver.

7. Application Note

7.1 2 Port Isolation

The antennas should be spaced at least 80mm apart to have minimum coupling interference, showing a similar return loss as in free space. Testing results for MIMO applications as follows:

Test Set up

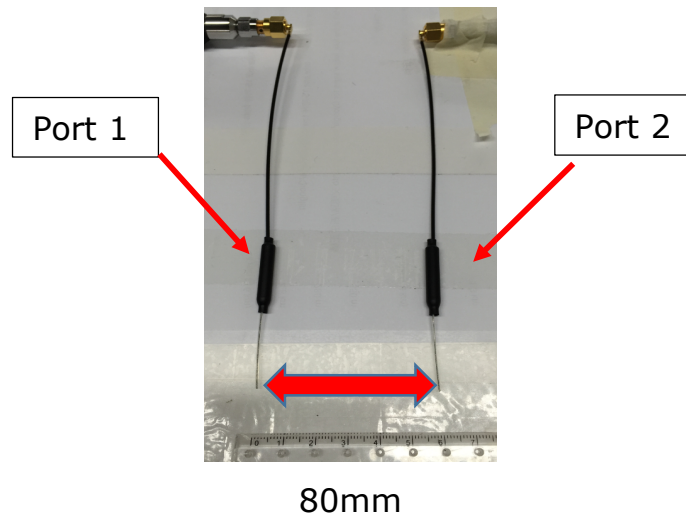

Port 1 S11

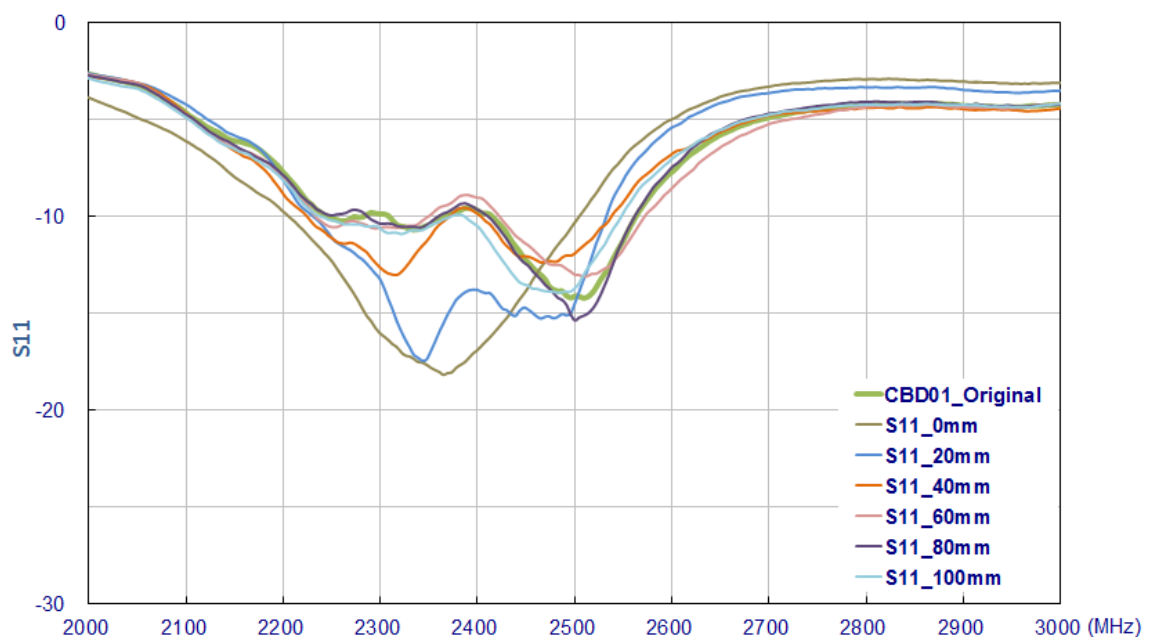

Port 2 S11

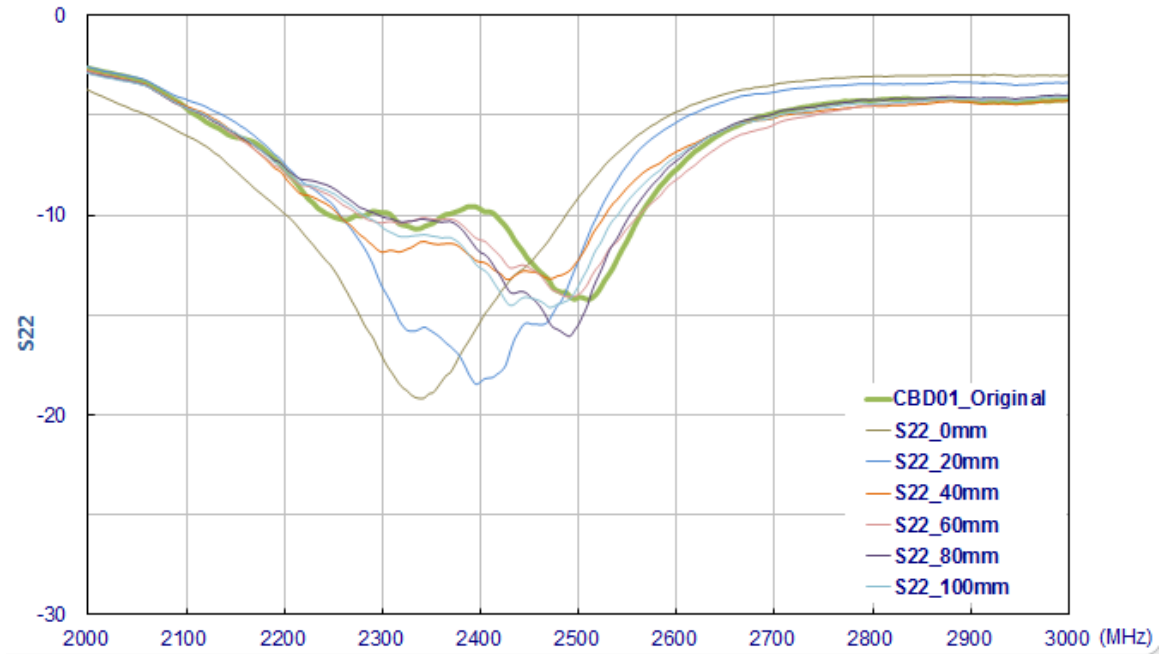

Two Ports Isolation

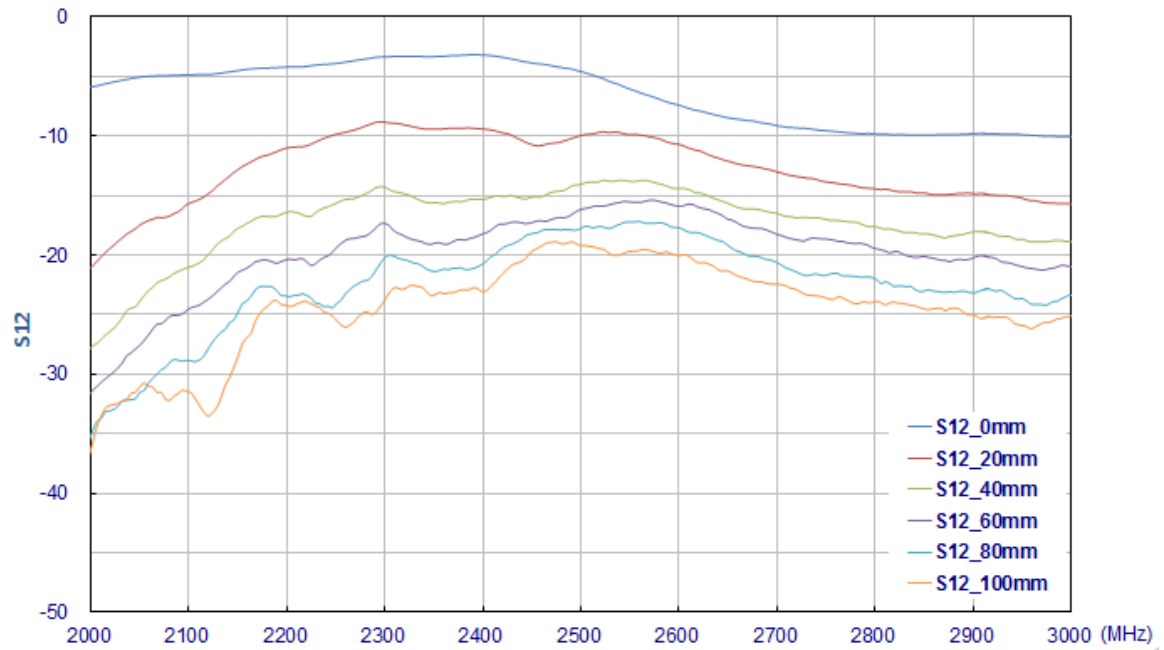

7.2 Ground Approximate Effects

The Antenna needs to be at least 54mm away from a comparatively large metal surface to have similar return loss as in free space. In order to maintain good antenna performance, we suggest that a suitable distance to large metal planes are reserved. If the distance is smaller than 54mm, Taoglas can offer the fine tuning service to prepare custom antennas, subject to minimum order quantities.

Test set up



54mm from Metal (Ground)

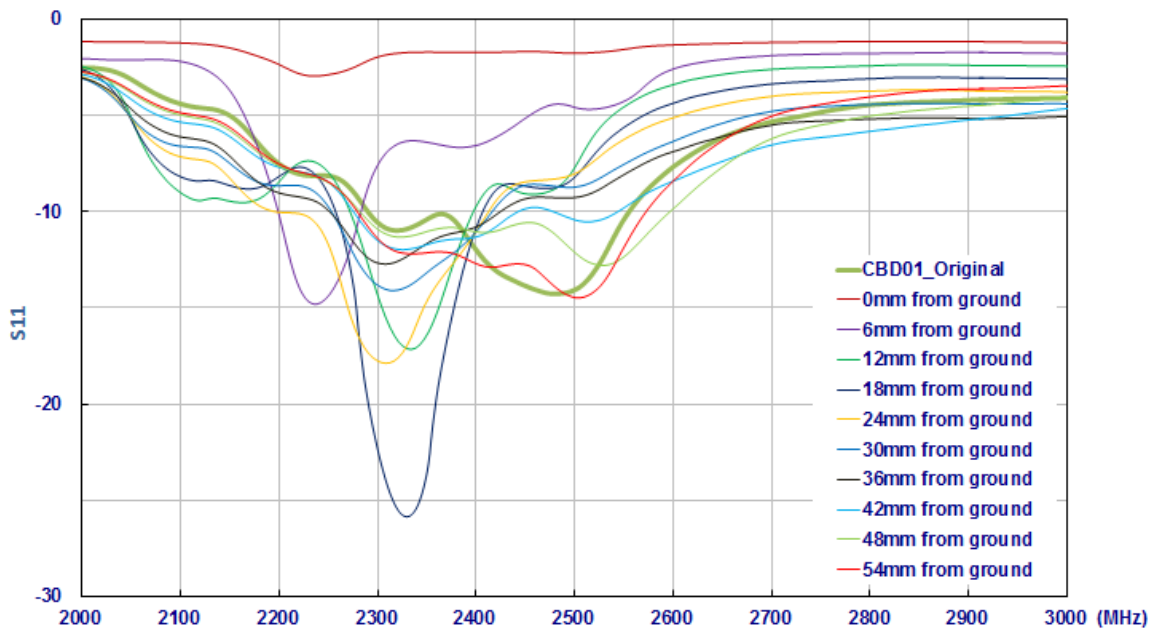

7.3 Bending Angle on Antenna Main Body

Due to the dipole antenna structure, cable routing of the antenna itself does not have much effect on performance. In real life scenarios however, the antenna matching and efficiency may be changed through bending the main body. The test setup and results below show the antennas response to bending.

Test Set up

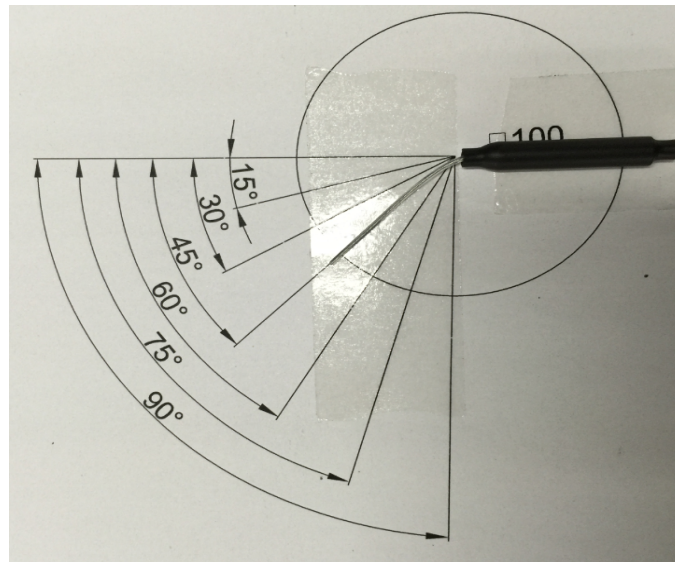

@45°

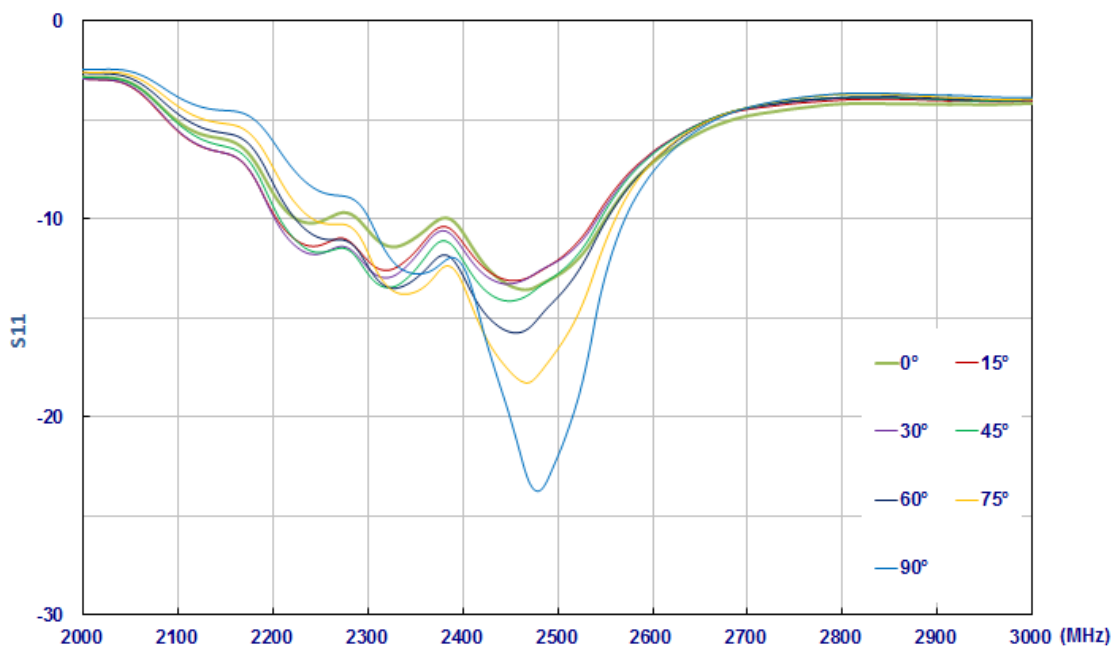

7.4 ABS Plastic

Proximity to plastic enclosures will affect antenna resonance. The test setup and return loss in free space, on 2mm thick ABS plastic (a common plastic housing and material thickness), and also, in between two pieces of 2mm thick ABS plastic, are shown below.

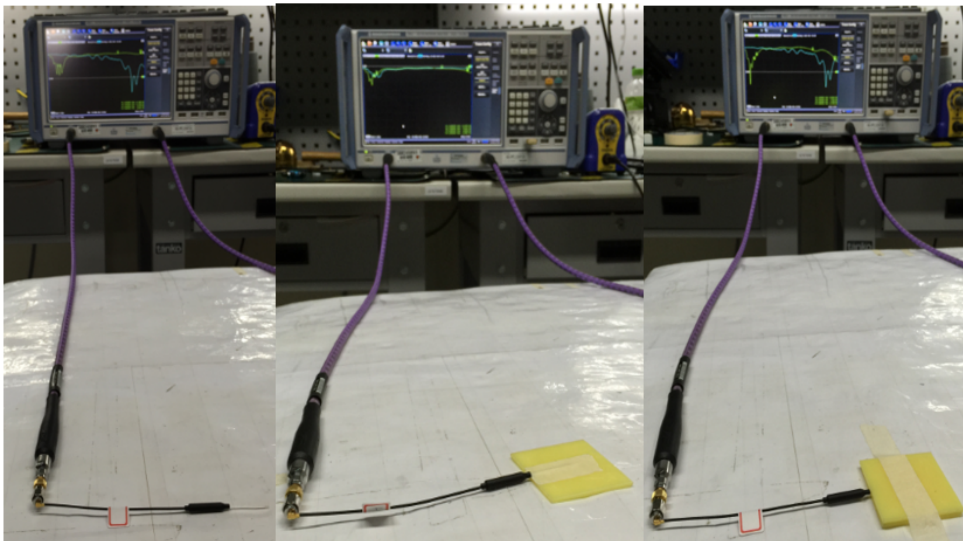

Free Space

On 2mm ABS

Between two 2mm ABS

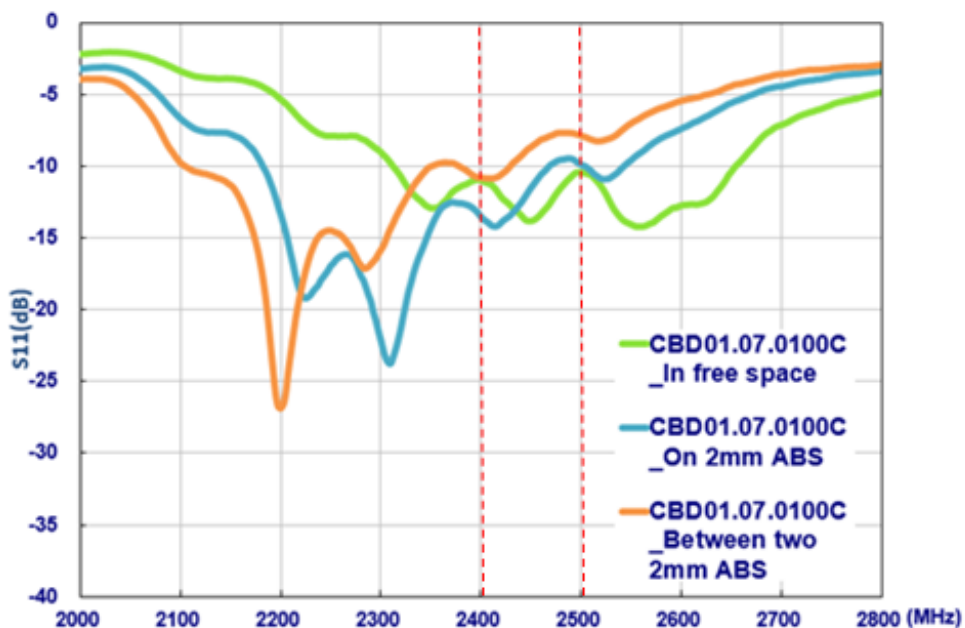

*Taoglas provides fine tuning service in order to get the best antenna performance in customer's device.