

CBT-140 White LEDs



Table of Contents

Technology Overview2

Test Specifications2

Binning Structure3

Chromaticity Bins4

Ordering Information6

Bin Kit Order Codes.....7

Shipping and Labeling 8

Electrical Characteristics . 10

Thermal Resistance 13

Mechanical Dimensions .. 14

Tray Outline 15

Packing and Shipping Specification..... 16

History of Changes..... 17

Features:

- Extremely high optical output from a 14 mm² circular source: Up to 5,000 white lumens
- Round emitting aperture provides most efficient match to circular optical systems and narrow beam projectors
- Unencapsulated package preserves small etendue facilitating narrow beam optical system design
- Chip on board package assures straightforward system assembly with the best possible thermal performance for high power devices.
- Integrated thermistor enables consistent temperature monitoring during operation for high system reliability
- High thermal conductivity package - junction to heat sink thermal resistance less than 0.25°C/W
- Variable drive current: 1 A to 28A
- High CRI (92 typical) Daylight color temperatures for natural lighting
- Environmentally friendly: RoHS compliant

Applications

- Architectural and Entertainment Lighting
- Fiber-coupled Illumination
- Medical Lighting
- Machine Vision
- Microscopy
- Spot Lighting

Technology Overview

Luminus LEDs™ benefit from a suite of innovations in the fields of chip technology, packaging and thermal management. These breakthroughs allow illumination engineers and designers to achieve solutions that are high brightness and high efficiency.

Monolithic Large Chip Technology

Luminus' technology enables large area LED chips with uniform brightness over the entire LED chip surface. The optical power and brightness produced by these large monolithic chips enable solutions which replace arc and halogen lamps where arrays of traditional high power LEDs cannot.

Packaging Technology

Thermal management is critical in high power LED applications. With a thermal resistance from junction to board of 0.25°C/W , Luminus CBT-140 LEDs have the lowest thermal resistance of any LED on the market. This allows the LED to be driven at higher current densities while maintaining a low junction temperature, thereby resulting in brighter solutions and longer lifetimes.

Reliability

Designed from the ground up, Luminus LEDs are one of the most reliable light sources in the world today. LEDs have passed a rigorous suite of environmental and mechanical stress tests, including mechanical shock, vibration, temperature cycling and humidity, and have been fully qualified for use in extreme high power and high current applications. With very low failure rates and median lifetimes that typically exceed 60,000 hours, Luminus LEDs are ready for even the most demanding applications.

Environmental Benefits

Luminus LEDs help reduce power consumption and the amount of hazardous waste entering the environment. All LED products manufactured by Luminus are RoHS compliant and free of hazardous materials, including lead and mercury.

Understanding Luminus LED Test Specifications

Every LED is fully tested to ensure that it meets the high quality standards expected from Luminus products.

Testing Temperature

Luminus core board products are typically measured in such a way that the characteristics reported agree with how the devices will actually perform when incorporated into a system. This measurement is accomplished by mounting the devices on a 40°C heat sink and allowing the device to reach thermal equilibrium while fully powered. Only after the device reaches equilibrium are the measurements taken. This method of measurement ensures that Luminus LEDs perform in the field just as they are specified.

Expected flux values in real world operation can be extrapolated based on the information contained within this product data sheet.

Multiple Operating Points

The tables on the following pages provide typical optical and electrical characteristics. Since the LEDs can be operated over a wide range of drive conditions (currents from 1A to 28.0A, and duty cycles from $<1\%$ to 100%), multiple drive conditions may be listed.

CBT-140 White LEDs are production tested at 21.0 A.

CBT-140 White Binning Structure

CBT-140 white LEDs are tested for luminous flux and chromaticity at a drive current of 21.0 A (1.5 A/mm²) and placed into one of the following luminous flux (FF) and chromaticity (WW) bins:

Flux Bins

| Color | Flux Bin (FF) | Minimum Flux (lm) at 21.0A | Maximum Flux (lm) at 21.0A |
|---|---------------|----------------------------|----------------------------|
| WCS (7500K-6500K, 70CRI) WDH (5700K 92CRI) | XA | 5,590 | 6,011 |
| | WB | 5,225 | 5,590 |
| | WA | 4,860 | 5,225 |
| | VB | 4,545 | 4,860 |
| | VA | 4,230 | 4,545 |
| | UB | 3,955 | 4,230 |
| | UA | 3,680 | 3,955 |
| | TB | 3,440 | 3,680 |
| | TA | 3,200 | 3,440 |
| | SB | 2,990 | 3,200 |
| | SA | 2,780 | 2,990 |
| | RB | 2,600 | 2,780 |
| | RA | 2,420 | 2,600 |
| | QB | 2,260 | 2,420 |
| QA | 2,100 | 2,260 | |

*Note: Luminus maintains a +/- 6% tolerance on flux measurements.

Luminus maintains a +/- 2% tolerance on CRI measurements.

Chromaticity Bins

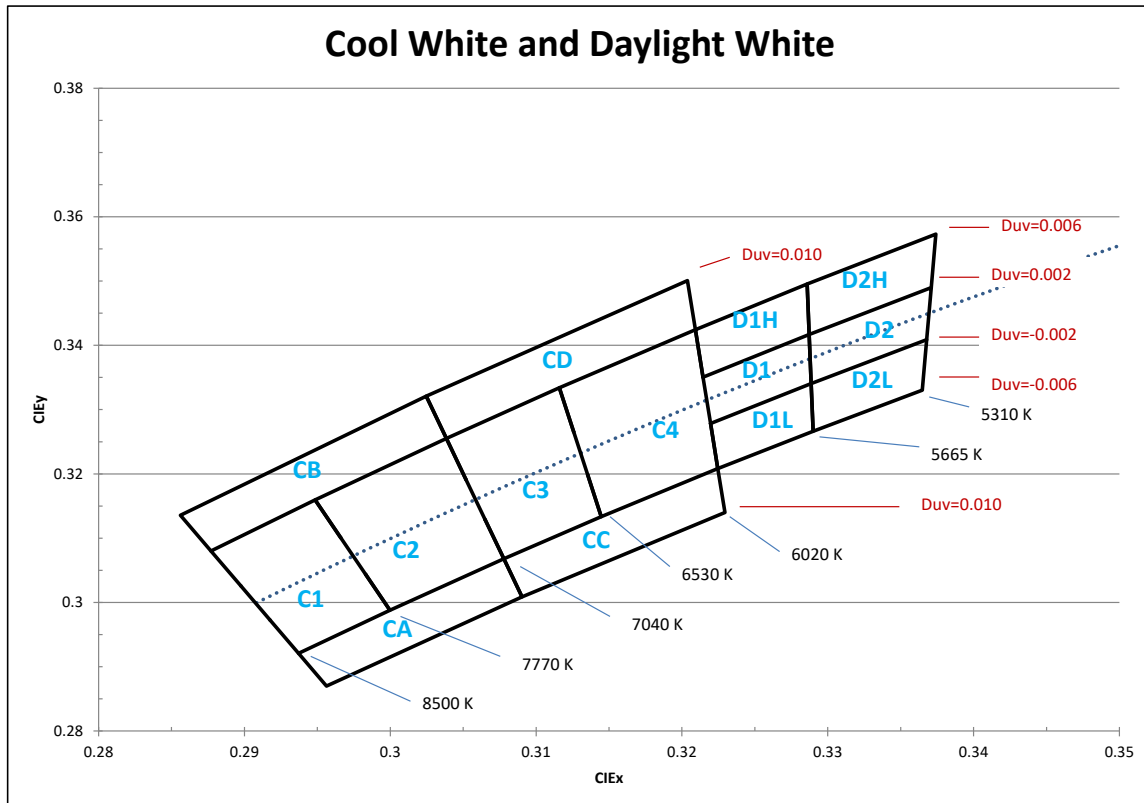

CBT-140 White Chromaticity Bins

The following tables describe the four chromaticity points that bound each chromaticity bin. Chromaticity bins are grouped together based on the color temperature.

| Cool White Chromaticity Bins | | |
|------------------------------|------------------|------------------|
| Bin Code(WW) | CIE _x | CIE _y |
| C1 | 0.293 | 0.292 |
| | 0.299 | 0.298 |
| | 0.294 | 0.315 |
| | 0.287 | 0.307 |
| C2 | 0.299 | 0.298 |
| | 0.307 | 0.306 |
| | 0.303 | 0.325 |
| | 0.294 | 0.315 |
| C3 | 0.307 | 0.306 |
| | 0.314 | 0.313 |
| | 0.311 | 0.333 |
| | 0.303 | 0.325 |
| C4 | 0.314 | 0.313 |
| | 0.322 | 0.32 |
| | 0.32 | 0.342 |
| | 0.311 | 0.333 |
| CA | 0.293 | 0.292 |
| | 0.295 | 0.287 |
| | 0.309 | 0.300 |
| | 0.307 | 0.306 |
| CB | 0.287 | 0.307 |
| | 0.285 | 0.313 |
| | 0.302 | 0.332 |
| | 0.303 | 0.325 |
| CC | 0.307 | 0.306 |
| | 0.309 | 0.300 |
| | 0.322 | 0.313 |
| | 0.322 | 0.320 |
| CD | 0.303 | 0.325 |
| | 0.302 | 0.332 |
| | 0.320 | 0.350 |
| | 0.320 | 0.342 |

| Daylight Chromaticity Bins | | |
|----------------------------|------------------|------------------|
| Bin Code(WW) | CIE _x | CIE _y |
| D1 | 0.321 | 0.327 |
| | 0.321 | 0.335 |
| | 0.328 | 0.341 |
| | 0.328 | 0.334 |
| D2 | 0.328 | 0.334 |
| | 0.328 | 0.341 |
| | 0.337 | 0.348 |
| | 0.336 | 0.340 |
| D1H | 0.321 | 0.335 |
| | 0.320 | 0.342 |
| | 0.328 | 0.349 |
| | 0.328 | 0.341 |
| D2H | 0.328 | 0.341 |
| | 0.328 | 0.349 |
| | 0.337 | 0.357 |
| | 0.337 | 0.348 |
| D1L | 0.321 | 0.327 |
| | 0.322 | 0.320 |
| | 0.328 | 0.326 |
| | 0.328 | 0.334 |
| D2L | 0.328 | 0.334 |
| | 0.328 | 0.326 |
| | 0.336 | 0.333 |
| | 0.336 | 0.340 |

Ordering Information

| Products | Ordering Part Number | Description |
|-------------|-----------------------|---|
| CBT-140-WCS | CBT-140-WCS-L16-xx123 | Monolithic LED with 14 mm ² circular emission area, un-encapsulated and integrated on a common anode copper-core PCB |
| CBT-140-WDH | CBT-140-WDH-L16-xx123 | |

Part Number Nomenclature

CBT — 140 — <ABC> — L16 — <FF###>

| Product Family | LED Emission Area | Color | Package Configuration | Bin kit |
|---|---------------------------|---|--|--|
| CBT: Copper-core PCB, No Encapsulation | 140: 14.0 mm ² | <A>: Color W = White : Temperature C = Cool White D = Daylight White <C> : Color Rendering Index S = Standard H = High CRI | L16: 28 mm x 26.75 mm - Common Anode Package, counter-bores | Flux and Chromaticity bin kit code - See available ordering codes next pages |

Examples

QB220 - denotes a bin kit comprising of all flux bins with a minimum flux of 2,260 lumens and chromaticity bins at daylight white color point.

QA720 - denotes a bin kit comprising of all flux bins with a minimum flux of 2,100 lumens and chromaticity bins at tungsten white color point.

CBT-140 Bin Kit Order Codes

The following tables describe the bin kit ordering codes available for the CBT-140 product family. Each bin kit specifies a minimum flux as well as specific chromaticity bins allowed. Please note that within each kit a maximum flux is not specified and as a result Luminus may ship any part meeting or exceeding the minimum flux specification. Shipments will always meet the listed chromaticity bins. For information on ordering bin kits not listed below, please contact Luminus or an official distributor.

CBT-140 Cool White Bin Kit Order Codes

| Color | Luminous Flux | | Chromaticity Bins | Kit Number |
|-----------------------------|-------------------|-----------|--------------------------------|------------|
| | Bin Kit Flux Code | Min. Flux | | |
| WCS 7500K-6500K 70CRI | TB | 3,440 | C1, C2, C3, C4, CA, CB, CC, CD | TB120 |
| | | | C1, C2, C3, C4 | TB121 |
| | | | C3, C4 | TB122 |
| | | | C1, C2 | TB123 |
| | UA | 3,680 | C1, C2, C3, C4, CA, CB, CC, CD | UA120 |
| | | | C1, C2, C3, C4 | UA121 |
| | | | C3, C4 | UA122 |
| | | | C1, C2 | UA123 |

CBT-140 Daylight White Bin Kit Order Codes

| Color | Luminous Flux | | Chromaticity Bins | Kit Number |
|--|-------------------|-----------|----------------------------|------------|
| | Bin Kit Flux Code | Min. Flux | | |
| WDH Daylight white, High CRI (typ. 92) | QA | 2,100 | D1, D2, D1H, D2H, D1L, D2L | QA220 |
| | QB | 2,260 | D1, D2, D1H, D2H, D1L, D2L | QB220 |
| | RA | 2,420 | D1, D2, D1H, D2H, D1L, D2L | RA220 |

Product Shipping & Labeling Information

All CBT-140 products are packaged and labeled with their respective bin as outlined in the tables and charts on pages 3, 4, & 5. When shipped, each package will only contain one bin. The part number designation is as follows:

CBT-140 White

CBT — **140** — **WNX** — **L16** — **FF** — **WW**

| Product Family | Chip Area | Color | Package Configuration | Flux Bin | Chromaticity Bin |
|-----------------------------|---------------------------|---------------------------------|-----------------------|---------------------|-----------------------|
| CBT: Chip on Board (window) | 140: 14.0 mm ² | Color & CRI See Note 1 below | Internal Code | See page 3 for bins | See page 4-5 for bins |

Note 1: WNX nomenclature corresponds to the following:

W = White

N = color, where:

C corresponds to Cool White,

D corresponds to Daylight White.

X = color rendering index, where:

S (Standard) corresponds to a typical CRI of 75

H (high) corresponds to a typical CRI of 92

Example :

The part label CBT-140-WDH-L16-RA-D1 refers to a Daylight high CRI white, CBT-140 emitter, with a flux range from 2,420 to 2,600 lumens and a

CBT-140 White Electrical Characteristics¹
Optical and Electrical Characteristics

| Drive Condition ² | | 21.0 A Continuous | |
|------------------------------|--------------------|-------------------------|-------------------|
| Parameter | Symbol | Values at Test Currents | Unit |
| Current Density | j | 1.5 | A/mm ² |
| Forward Voltage | V _{F,min} | 3.4 | V |
| | V _{F,typ} | 3.6 | V |
| | V _{F,max} | 4.2 | V |

Common Characteristics

| Parameter | Symbol | Typical Values | Unit |
|---|----------------|----------------|-----------------|
| Emitting Area | | 14.0 | mm ² |
| Color Rendering Index (Typical) | Cool White | CRI | 75 |
| | Daylight White | CRI | 92 |
| Forward Voltage Temperature Coefficient | | -5.47 | mV/°C |

Absolute Maximum Ratings

| Parameter | Symbol | Values | Unit |
|---|--------------------|----------|------|
| Minimum Drive Current ⁷ | | 0.2 | A |
| Maximum Current ⁵ | | 28.0 | A |
| Maximum Junction Temperature ⁶ | T _{J-max} | 150 | °C |
| Storage Temperature Range | | -40/+100 | °C |

Note 1: Ratings are based on operation with a constant junction temperature of T_j = 85°C.

Note 2: Listed drive conditions are typical for common applications. CBT-140 white devices can be driven at currents ranging from 1A to 28A and at duty cycles ranging from 1% to 100%. Drive current and duty cycle should be adjusted as necessary to maintain the junction temperature desired to meet application lifetime requirements.

Note 3: Unless otherwise noted, values listed are typical.

Note 4: CCT value based off of CIE measurement. CIE X and CIE Y measurement uncertainty for white devices is estimated to be +/- 0.01.

Note 5: CBT-140 White LEDs are designed for operation to an absolute maximum forward drive current density of 2.0A/mm². Product lifetime data is specified at recommended forward drive currents. Sustained operation at absolute maximum currents will result in a reduction of device lifetime compared to recommended forward drive currents. Actual device lifetimes will also depend on junction temperature. Refer to the lifetime derating curves for further information. In pulsed operation, rise time from 10-90% of forward current should be larger than 0.5 microseconds.

Note 6: Lifetime dependent on LED junction temperature. Input power and thermal system must be properly managed to ensure lifetime. See charts on pg 12 for further information.

Note 7: Special design considerations must be observed for operation under 1 A. Please contact Luminus for further information.

Note 8: Caution must be taken not to stare at the light emitted from these LEDs. Under special circumstances, the high intensity could damage the eye.

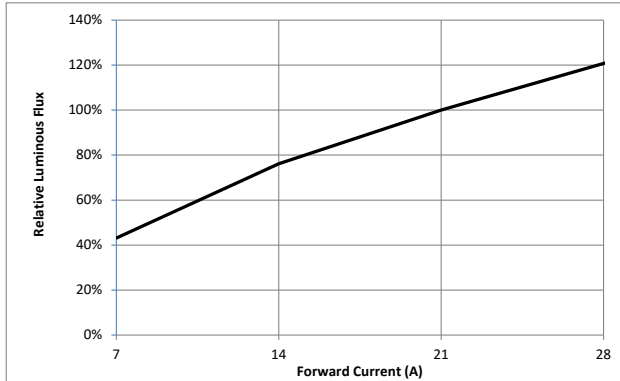
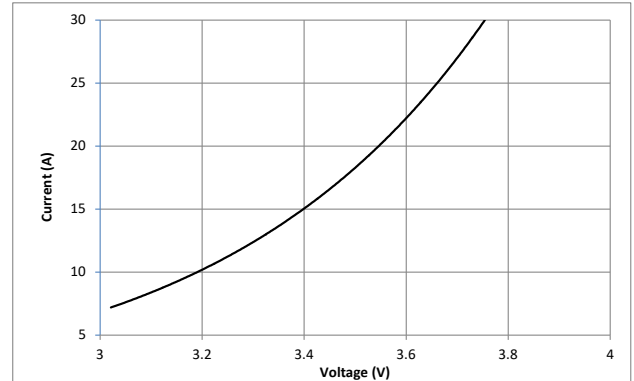
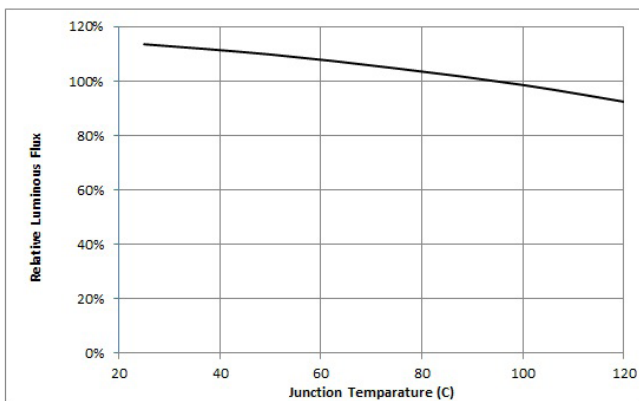
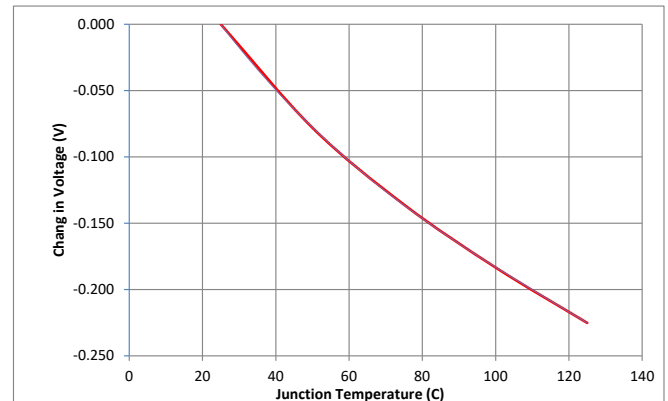
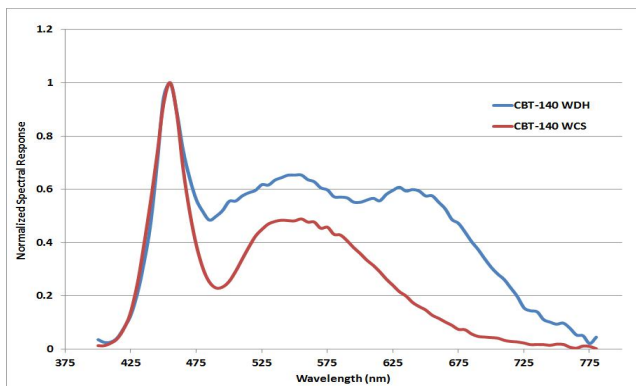
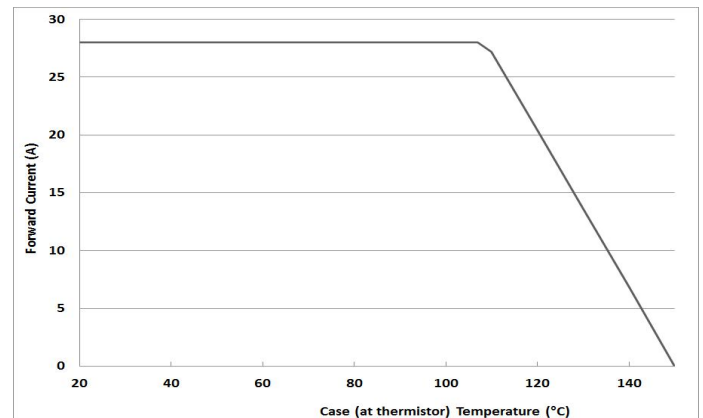
CBT-140 White Optical & Electrical Characteristics
Relative Output Flux vs. Forward Current

Forward Current vs. Forward Voltage

Relative Output Flux vs. Junction Temp

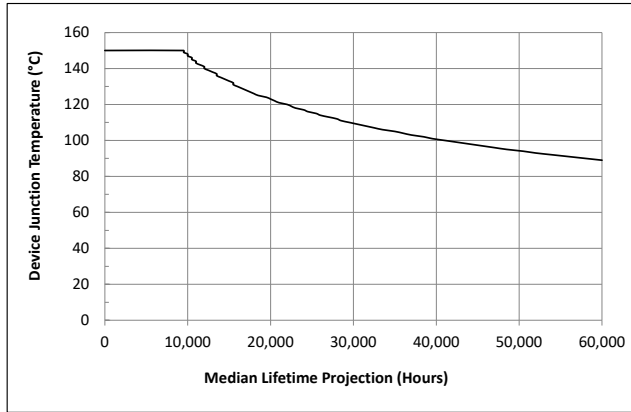
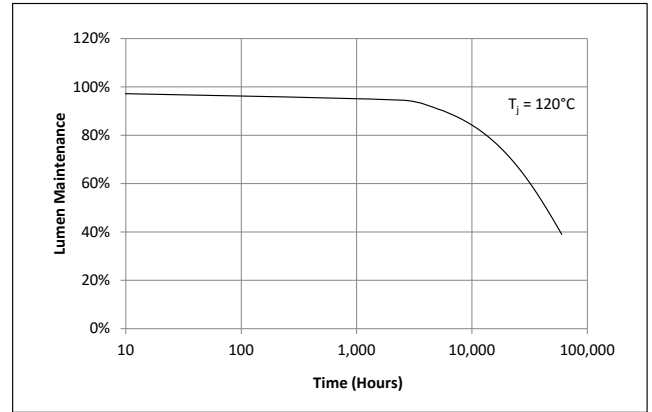
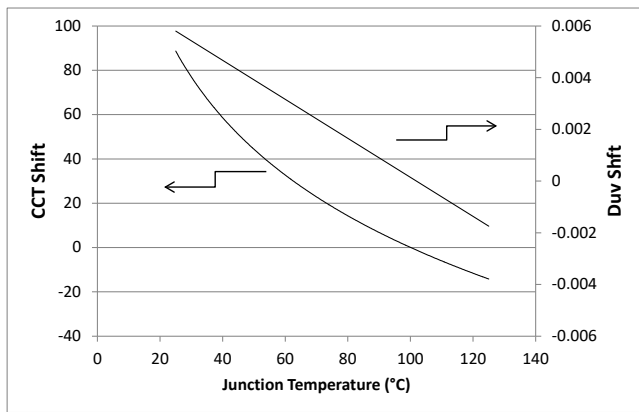
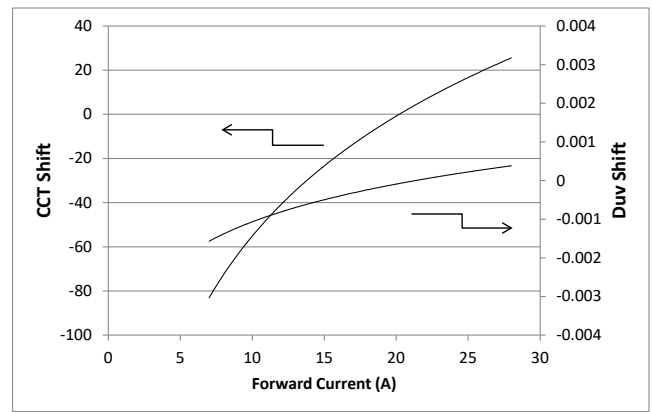
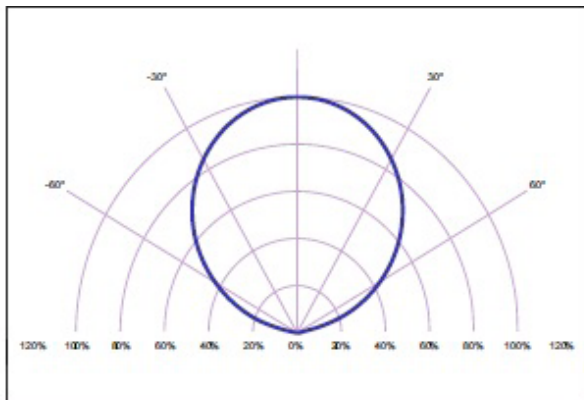
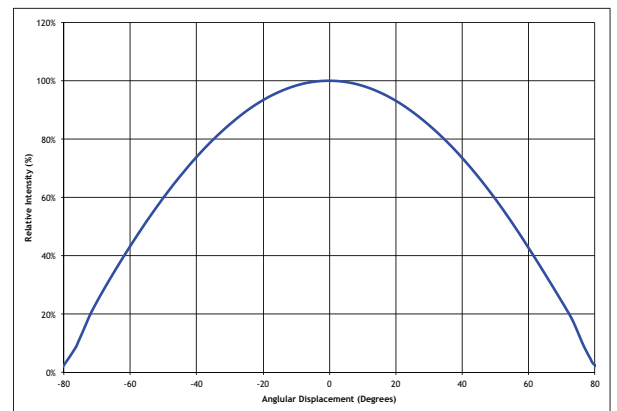
Change in Voltage vs. Junction Temp

Typical Spectrum¹

Current Derating Curve²

Note 1: Typical spectrum at current density of 1.5 A/mm² in continuous operation.

Note 2: Maximum drive current to comply with maximum junction temperature in continuous mode. Junction temperature should be maintained at level compatible with lifetime desired with may require further current de-rating

CBT-140 White Optical & Electrical Characteristics
Median Lifetime²

Lumen Maintenance vs. Time³

Chromaticity Change vs. Junction Temp

Chromaticity Change vs. Forward Current

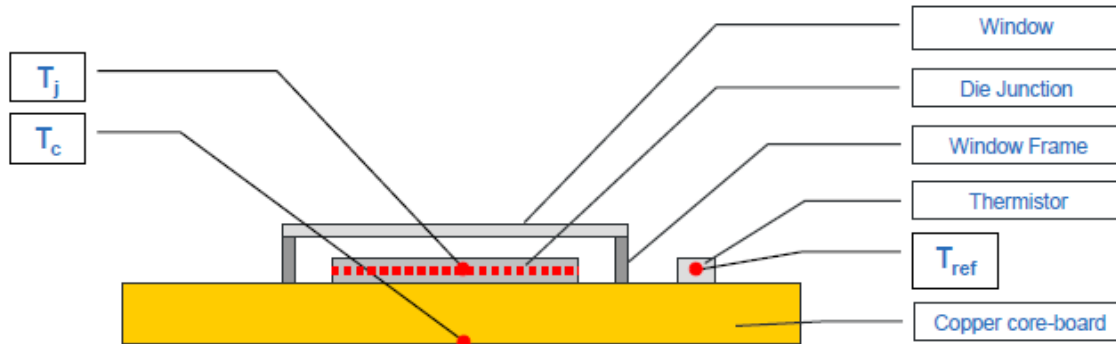
Typical Polar Radiation Pattern

Typical Angular Radiation Pattern

Note 2: Median expected lifetime in dependence of junction temperature at 1.5 A/mm² in continuous operation. Lifetime defined as time to 70% of initial intensity. Based on lifetime test data. Data can be used to model failure rate over typical product lifetime (contact Luminus for lifetime reliability test data for 1A/mm² condition).

Note 3: Lumen maintenance in dependence of time at 1.5 A/mm² in continuous operation with junction temperatures of 120 °C.

Thermal Resistance



Typical Thermal Resistance

| | |
|-------------------------|-----------|
| R_{j-c}^{-1} | 0.30 °C/W |
| R_{j-ref}^{-1} | 0.33 °C/W |
| $Electrical_{j-c}^{-1}$ | 0.25 °C/W |

Note 1: Thermal resistance values are based on modeled results.

Thermistor Information

The on-board thermistor used in CBT-140 LEDs mounted on core-boards is from Murata Manufacturing Co. The global part number is NCP18XH103J03RB. Please see <http://www.murata.com/> for details on calculating thermistor temperature.

Electrical Pinout

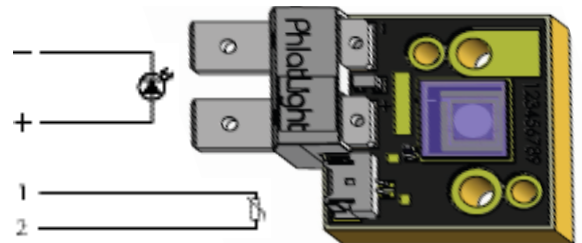

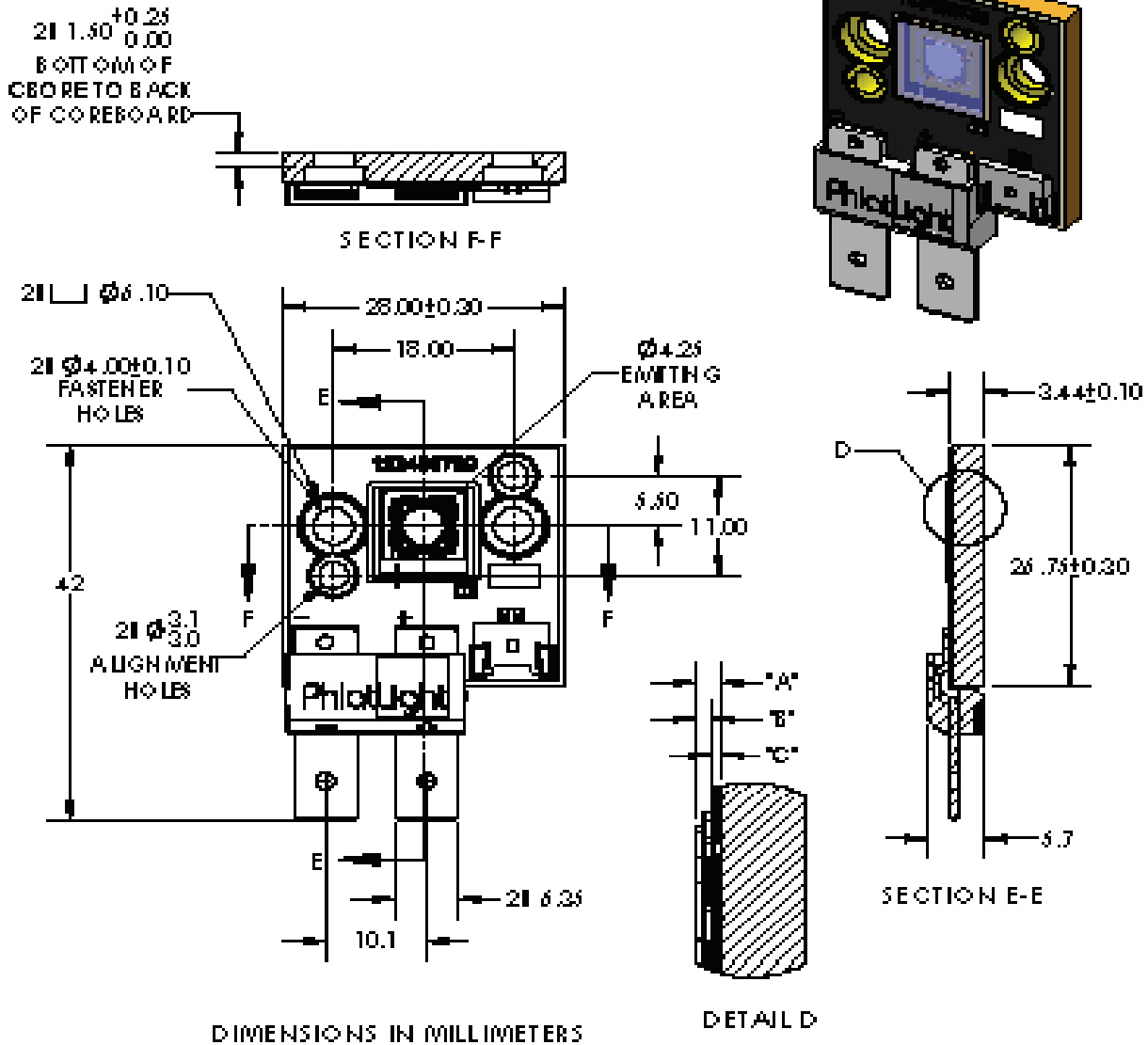
Mechanical Dimensions – CBT-140 Emitter

| DIMENSION NAME | DESCRIPTION | NOMINAL DIMENSION | TOLERANCE |
|----------------|--|-------------------|-----------|
| "A" | TOP OF METAL SUBSTRATE TO TOP OF WINDOW | 0.95 | ±0.13 |
| "B" | TOP OF DIE EMITTING AREA TO TOP OF WINDOW | 0.63 | ±0.11 |
| "C" | TOP OF METAL SUBSTRATE TO TOP OF DIE EMITTING AREA | 0.31 | ±0.02 |

DWG-002161

Re:
 Thermistor Connector: MOLEX P/N 53780-0270 or GCT P/N WTB08-0215-F
 Recommended Female: MOLEX P/N 51146-0200, GCT P/N WTB06-0215-F or equivalent
 For detailed drawing please refer to DWG-001997 document

Shipping Tray Outline

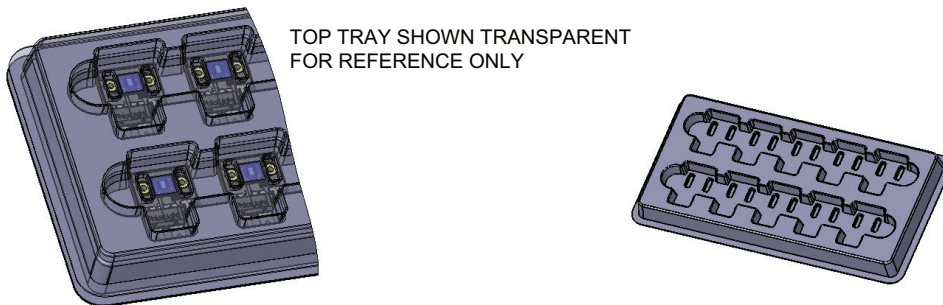
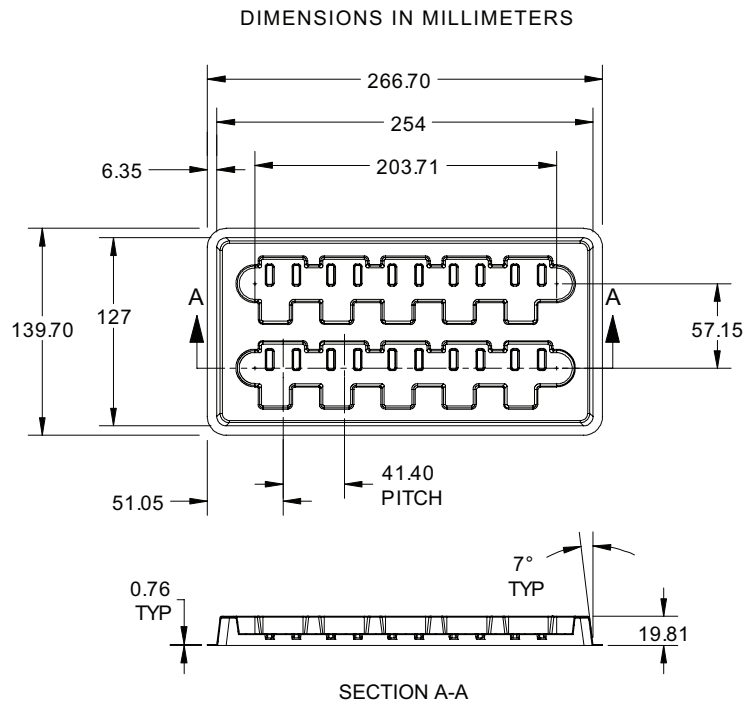

For detailed drawing of shipping trays, please refer to document TO-0479, available upon request.

Packing and Shipping Specification (CBT-140)

Packing Specification

| Packing Configuration | Qty /Pack | Reel Dimensions (diameter x W, mm) | Gross Weight (kg) |
|---|-----------|---------------------------------------|-------------------|
| Stack of 5 trays with 10 devices per tray Each pack is enclosed in ESD bag | 50 | 150 x 280 x 85 | 2.7 |

Product Label Specification

Label Fields (subject to change):

- 6-8 digit Box number (for Luminus internal use)
- Luminus ordering part number
- Quantity of devices in pack
- Part number revision (for Luminus internal use)
- Customer's part number (optional)
- Bin (FF-WW) as defined page 3
- 2D Bar code





LUMINUS
LEADER IN BIG CHIP LEDS Solid State Filament™

BT-012345

 Box number

Qty: 50



PT-120-G-L11-MPG

 Luminus part number

Rev 01

12345678

 Customer part number

5F

 Bin

RoHS Compliant

for traceability peel off label and attach

Sample label –for illustration only

Shipping Box

| Shipping Box | Quantity | Material | Dimensions (L x W x H, mm) |
|--------------|------------------------------------|----------|-------------------------------|
| Carton Box | 1 -20 packs (50 - 1000 Devices) | S4651 | 560 x 560 x 200 |

