

# Table of Specifications

## Midi-Contactors



Frame size	
Type	Terminal type
Number of poles	
Rated operational voltage, Ue	
Rated insulation voltage, Ui	
Rated frequency	
Rated impulse withstand voltage, Uimp	
Maximum operating rate in operating cycles per hour(AC3)	
Durability	Mechanical
	Electrical
Current and power	AC-1, Thermal current A
	AC-3 200/240V kW
	380/440V kW
	500/550V kW
	690V kW
UL rating (50/60Hz)	Continuous current A
	Single phase 110~120V HP
	220~240V HP
	200~208V HP
	Three phase 220~240V HP
	440~480V HP
Size and weight	NEMA size
	Weight kg
Size and weight	Size(W × H × D) mm
	Weight kg
Auxiliary(standard)	Side mount
	Front mount



22AF			
CC9	CC12	CC18	CC22
Screw Only			
3pole			
690V			
690V			
50/60Hz			
6kV			
1800 operations per hour			
15 mil. operations			
2.5 mil. operations			
25	25	32	40
2.5	3.5	4.5	5.5
11	13	18	22
4	5.5	7.5	11
9	12	18	22
4	7.5	7.5	15
7	12	13	20
4	7.5	7.5	15
6	9	9	18
25	25	40	40
0.5	0.75	1	2
1.5	2	3	3
2	3	5	7.5
3	5	7.5	10
5	7.5	10	15
7.5	10	15	20
00	00	0	1
0.34			
45 × 73.5 × 86			
0.51			
45 × 73.5 × 117.7			
GUA1, GUA2, GUA4			
GUA-1			
GUA-2, GUA-4			

40AF	
CC32	CC40
Screw Only	
3pole	
690V	
1000V	
50/60Hz	
8kV	
1800 operations per hour	
12 mil. operations	
2 mil. operations	
50	60
7.5	11
32	40
15	18.5
32	40
18.5	22
28	32
18.5	22
20	23
50	60
2	3
5	7.5
7.5	15
10	15
20	30
25	30
1	1
0.55	
69 × 83 × 93	
0.77	
69 × 83 × 120	
GUA-1	
GUA-2, GUA-4	

Note) Minimum conduct current of Auxiliary contactor is DC 17V 5mA.

## GT Type Thermal Overload Relays



Type	Screws clamp terminals
Rated operational voltage, Ue	
Rated insulation voltage, Ui	
Rated impulse withstand voltage, Uimp	
Trip class	
Setting range	
Size and weight	Weight kg
	Size(W × H × D) mm



GT32
690V
690V
6kV
10A, 20
0.1~40A
0.17
45 × 75 × 90

GT32
690V
690V
6kV
10A, 20
0.1~40A
0.17
45 × 75 × 90

# Table of Specifications



65AF	
CC50	CC65
Screw or Lug	
3pole	
690V	
1000V	
50/60Hz	
8kV	
1800 operations per hour	
12 mil. operations	
2 mil. operations	
70	100
15	18,5
55	65
22	30
50	65
30	33
43	60
30	33
28	35
70	100
3	5
10	15
20	25
25	30
40	50
50	60
2	2
1.05	
79 × 106 × 122	
1.3	
79 × 106 × 149	

GUA-1
GUA-2, GUA-4



GT63
•
690V
690V
6kV
10A, 20
4~65A
0.31/0.33
55 × 81 × 100



100AF		
CC75	CC85	CC100
Screw or Lug		
3pole		
690V		
1000V		
50/60Hz		
8kV		
1800 operations per hour		
12 mil. operations		
2 mil. operations		
110	135	160
22	25	30
75	85	105
37	45	55
75	85	105
37	45	55
64	75	85
37	45	45
42	45	65
110	135	160
5	7.5	10
15	15	20
25	30	30
30	40	40
50	60	75
60	75	75
2	3	3
1.93		
94 × 140 × 137		
2.8		
94 × 140 × 174		

GUA-1
GUA-2, GUA-4



GT95
•
690V
690V
6kV
10A, 20
7~100A
0.48/0.5
70 × 97 × 110

# Table of Specifications



400AF		
CC265*	CC330*	CC400*
Screw Only		
3pole		
690V		
1000V		
50/60Hz		
8kV		
1200 operations per hour		
5 mil. operations		2.5 mil. operations
1 mil. operations		0.5 mil. operations
300	350	450
80	90	125
265	330	400
147	160	200
265	330	400
147	160	225
225	280	350
160	200	250
185	225	300
300	350	450
-	-	-
-	-	-
75	100	125
100	125	150
200	250	300
200	250	300
5	5	5

9.2  
163 × 243 × 198

2a2b		
-	-	-



GT400		
●		
690V		
690V		
6kV		
10A, 20		
85~400A		
2.6		

151 × 171 × 198



800AF		
CC500*	CC630*	CC800*
Screw Only		
3pole		
690V		
1000V		
50/60Hz		
8kV		
1200 operations per hour		
2.5 mil. operations		0.5 mil. operations
580	660	900
147	190	220
500	630	800
265	330	440
500	630	800
265	330	500
400	500	720
300	400	500
380	420	630
580	660	900
-	-	-
-	-	-
150	200	200
200	250	300
400	500	600
400	500	600
6	6	7

22.4  
285 × 312 × 242

2a2b		
-	-	-



GT800		
●		
690V		
690V		
6kV		
10A, 20		
200~800A		
11.5		

360 × 530 × 212

# Type Numbering System

## Midi-Contactor

<b>CC</b> Magnetic 3-pole Midi-Contactor	<b>9</b> Amperage Size	<b>BLANK</b> Type 3-pole /4-4-pole	<b>S</b> Terminal Type S - Screw L - Lug (>50A)	<b>A</b> Coil Type A - AC type D - DC type	<b>120</b> Coil Voltage 24 - 24V 120 - 120V & 600 - 600V	<b>BLANK</b> AC Coil Frequency - 50/60 Hz 50Hz - 50Hz only 60Hz - 60Hz only	<b>BLANK</b> Auxiliary Contact s - standard arrangement <b>NOAUX</b> - no aux. contact (>=32A)
	9 - 9A 12 - 12A 18 - 18A 22 - 22A 32 - 32A 40 - 40A 50 - 50A 65 - 65A 75 - 75A 85 - 85A 100 - 100A						

## Overload

<b>GT</b> Bimetallic Midi-Overload	<b>32</b> Frame Size	<b>BLANK</b> Class class 10 L - class 20	<b>S</b> Terminal Type (Must match contactor number) S - Screw L - Lug (>35A)	<b>0.16A</b> Setting Ranges (Use upper limit in part)
	32 - 9, 12, 18A 22, 32, 40A 65 - 50, 65A 75 - 75, 85, 100A			0.1 ~ 0.16A 0.16 ~ 0.25A 0.25 ~ 0.4A 0.4 ~ 0.63A 0.63 ~ 1A 1 ~ 1.6A 1.6 ~ 2.5A 2.5 ~ 4A 4 ~ 6A 5 ~ 8A 6 ~ 9A 7 ~ 10A 9 ~ 13A 12 ~ 18A 16 ~ 22A 18 ~ 25A 22 ~ 32A 24 ~ 36A 28 ~ 40A 34 ~ 50A 45 ~ 65A 54 ~ 75A 63 ~ 85A 70 ~ 95A 80 ~ 100A (Setting Range Guide)
<b>CGE</b> Electronic Midi Overload	<b>22</b> Frame Size	<b>3P</b> Protection	<b>22A</b> Setting Range (Use upper limit in part)	
	22 - 9, 12, 18, 22A 40 - 32, 40A 80 - 50, 65, 75, 85A	Direct Mount 22 and 40AF 2P - 2-Pole 3P - 3-Pole 3PR - 3-pole	<b>CGE22</b> 0.3 ~ 1.5A 1 ~ 5A 4.4 ~ 22A	
		Separate Mount All CGE sizes 2S - 2-Pole 3S - 3-Pole 3SR - 3-Pole	<b>CGE40</b> 4 ~ 20A 8 ~ 40A <b>CGE80</b> 16 ~ 80A	
		Tunnel Type 22 and 40AF 2T - 2-Pole 3T - 3-Pole 3TR - 3-Pole		

## Optional Accessories

### Auxiliary contact unit



Version	Contact composition
GUA1 Side mount	11 1NO+1NC
GUA2 Front mount(2P)	20 2NO
GUA4 Front mount(4P)	02 2NC
	40 4NO
	31 3NO+1NC
	22 2NO+2NC
	13 1NO+3NC
	04 4NC

### Surge absorber



Composition and voltage		
1	Varistor+RC	AC/DC 24~48V
2	Varistor+RC	AC/DC 100~125V
3	Varistor+RC	AC/DC 200~240V
4	Varistor+RC	AC 380~440V
5	Varistor+RC	AC 24~48V
6	Varistor+RC	AC 100~125V
11	Varistor	AC 200~240V
12	Varistor	DC 24~48V
13	Varistor	DC 100~125V
14	Varistor	DC 200~220V
22	RC	AC 100~125V

Note) See page 52 for details.

### Interlock unit



Contact composition
02 2NC

### Wire kit for Interlocking



Frame size
22 22AF
32 32AF
63 63AF
95 95AF

### Separate mounting unit (For relay)



Frame size
32 32AF
63 63AF
95 95AF
150 150AF

### Remote reset unit (For relay)



Cable length
16 400
20 500
24 600

# Environment / Connections

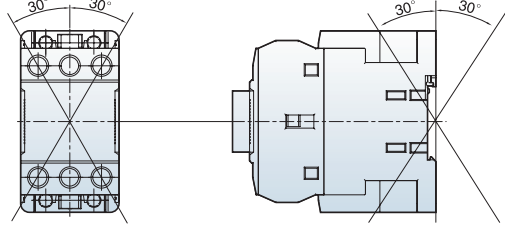

## Environment

Standards	IEC/EN 60947-1, IEC/EN 60947-4-1, UL508, K60947
Certifications	CE, UL
Rated insulation voltage (Ui)	1000V
Rated impulse withstand voltage (Uimp)	8kV
Degree of protection	IP20 (Conforming to IEC60529)
Ambient air temperature	Storage: -50° C ~ +80° C Operation: -5° C ~ +60° C
Operating altitude	3000m (8900ft)
Operating positions	
Shock resistance (1/2 sine wave =11ms)	Opened: 8G Closed: 10G
Vibration resistance (Conforming to IEC68-2-6) (5...300 Hz)	Opened: 2G Closed: 4G
Flame resistance	Conforming to UL 94: Vo Conforming to IEC 695-2-1: 960° C

## Connections

Frame	Wire type	Main Terminal Size	Wire types						Torque	
			(AWG / mm <sup>2</sup> )			mm(max)			[lb-in]	[Nm]
CC9		M4	18~10 / 1~6	18~10 / 1~6	18~10 / 1~6	9.6	20	2.25		
CC12			18~10 / 1~6	16~10 / 1~6	16~10 / 1~6					
CC18			18~10 / 1~6	16~8 / 1.5~10	16~8 / 1.5~10					
CC22		M5	18~10 / 1~6	14~8 / 2.5~10	14~8 / 2.5~10	12.8	35	4		
CC32			18~10 / 1~6	12~8 / 2.5~10	12~8 / 2.5~10					
CC40		M6	-	10~4 / 6~25	10~4 / 6~25	14	35	4		
CC50			-	8~3 / 10~35	8~3 / 10~35					
CC65			-	8~2 / 10~35	8~2 / 10~35					
CC75		M8	-	8~1/0 / 10~50	8~1/0 / 10~50	17	45	5.1		
CC85			-	8~2/0 / 10~70	8~2/0 / 10~70					
CC100		M8	-	3~2/0 / 35~70	3~2/0 / 35~70	24.5	80	9.1		
CC110			-	3~4/0 / 35~95	3~4/0 / 35~95					
CC130		M8	-	3~2/0 / 35~70	3~2/0 / 35~70	24.5	80	9.1		
CC150			-	3~4/0 / 35~95	3~4/0 / 35~95					
CC9~150		M4	20~14 / 0.5~2.5	18~12 / 0.75~2.5	18~12 / 0.75~2.5	7.6	15	1.75		
CC185		M10	-	1~4/0 / 50~95	1~4/0 / 50~95	25	130	14.7		
CC225			-	1/0~300 / 50~150	1/0~300 / 50~150					
CC265		M12	-	3/0~500 / 95~240	3/0~500 / 95~240	30	200	22.6		
CC330			-	4/0~500 / 95~240	4/0~500 / 95~240					
CC400		M16	-	350~700 / 185~185x2	350~700 / 185~185x2	40	500	26.5		
CC500			-	350~800 / 185~240x2	350~800 / 185~240x2					
CC630		M16	-	600~2000	-	40	500	26.5		
CC800			-	1700~Busbar	-					
CC185~800		M4	20~14 / 0.5~2.5	18~12 / 0.75~2.5	18~12 / 0.75~2.5	7.6	15	1.75		

a data sheet and specify products, visit [www.CavazziOnline.com](http://www.CavazziOnline.com)

# Control Coil Characteristics



Frame size		22AF	40AF	65AF	100AF	150AF
Type		CC9	CC32	CC50	CC75	CC130
		CC12	CC40	CC65	CC85	CC150
		CC12			CC100	
		CC22				
<b>AC coil</b>						
Control voltage	[Uc]	24, 32, 36, 42, 48, 80, 100, 110, 220, 230, 240, 380, 400, 415, 440, 500, 550V				24, 48, 110,
	50Hz [V]	24, 48, 100, 110, 120, 200, 208, 220, 230, 240, 277, 380, 440, 480, 600V				220, 300,
	60Hz [V]	24, 48, 100, 110, 120, 200, 220, 230, 240, 380, 415, 440, 500, 550V				400, 500
Voltage limit	[Uc]					
	Pick-up	85 ~110% (50Hz)				
	Drop-out	85 ~110% (60Hz)				
Coil consumption at 20°C		30 ~ 60%				
	AC 220V Inrush [VA]	58/56	53/50	110/104	229/216	108/104
	50/60Hz Holding [VA]	9.0/6.0	12.0/9.0	13.0/10.0	17.0/13.0	18.0/21.0
Heat dissipation	[W]	2.1/1.5	2.7/2.2	2.8/2.4	5.4/4.7	2.7/3.6
Operating time						
	Closing [ms]	12 ... 22	12 ... 22	12 ... 22	15 ... 30	20 ... 40
	Opening [ms]	4 ... 19	4 ... 19	4 ... 19	10 ... 30	60 ... 70
<b>DC coil</b>						
Control voltage	[Uc]	12, 20, 24, 48, 60, 80, 100, 110, 125, 200, 220, 250				24, 48, 110, 220
Voltage limit	[Uc]					
	Pick-up	70 ~ 110%				
	Drop-out	10 ~ 30%				
Coil consumption at 20°C						
	DC 110V Inrush [W]	9	7	9	18	213
	Holding [W]	9	7	9	18	7.5
Time constant (L/R)	[ms]	28	28	65	75	
Operating time						
	Closing [ms]	35 ... 50	50 ... 65	50 ... 65	100 ... 120	70 ... 80
	Opening [ms]	4 ... 19	4 ... 19	4 ... 19	10 ... 25	60 ... 70

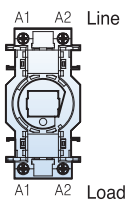

Note) A1(A2) in line side is internally connected to A1(A2) in load side.

To instantly view a data sheet and specify products, visit [www.GavazziOnline.com](http://www.GavazziOnline.com)

# Control Coil Characteristics



Frame size	225AF	400AF	800AF
Type	<b>CC185</b> <b>CC225</b>	<b>CC265</b> <b>CC330</b> <b>CC400</b>	<b>CC500</b> <b>CC630</b> <b>CC800</b>
<b>AC/DC common coil</b>			
Control voltage [Uc]			
AC/DC	24/24	-	-
AC/DC	48/48	-	100/100
AC/DC	100~240/100~220	100~240/100~220	200/200
AC	300	300	300
AC	400	400	400
AC	500	500	500
Voltage limit [Uc]			
Pick-up		86~110%	
Drop-out		30~60%	
Coil consumption at 20°C			
AC 220V Inrush [VA]	380	571	1000
50/60Hz Holding [VA]	11.6	14	29
Heat dissipation [W]	4.7	5	7.8
Operating time			
Closing [ms]	70	55	75
Opening [ms]	70	55	75

# Internal Structure





# Contactors (150AF)

## Description

- 3-pole(NO) main contact
- Finger proof design
- DIN rail or screw mountable
- AC or DC control in the same physical size
- Front/side mountable accessories available
- Direct mountable overload relay available
- 2NO2NC Auxiliary contacts built-in as standard

## Rating



CC150

Contactor type			CC130		CC150		
			kW	A	kW	A	
AC duty	AC3	200/240V	37	130	45	150	
		380/440V	60	130	75	150	
		500/550V	60	90	70	100	
		690V	55	60	55	60	
	AC4	200/240V	22	93	30	120	
		380/440V	45	90	55	110	
	AC1		-	160	-	210	
DC1 duty (L/R=1ms)	2-pole	24V	-	120	-	150	
		in series	48V	-	100	-	120
		110V	-	80	-	100	
	3-pole	24V	-	120	-	150	
		in series	48V	-	120	-	150
		110V	-	100	-	150	
DC2, 4 duty (L/R=15ms)	2-pole	24V	-	120	-	150	
		in series	48V	-	60	-	100
		110V	-	40	-	80	
	3-pole	24V	-	120	-	150	
		in series	48V	-	90	-	130
		110V	-	80	-	120	
Directly mountable Overload relay			<b>GT150</b>				
Conductor size (solid, stranded) (the max. number of conducts: 2)	AWG		3~00		3~00		
	mm <sup>2</sup>		35~70		35~95		
Conductor type			65/75°C Cu-wire only				



## Coil Voltage

AC	50/60Hz	24, 48, 110, 220, 300, 400, 500V
DC	DC	24, 48, 110, 220V

## Certification

- CE(IEC)
- UL508

# Contactors (150AF)

## Accessories

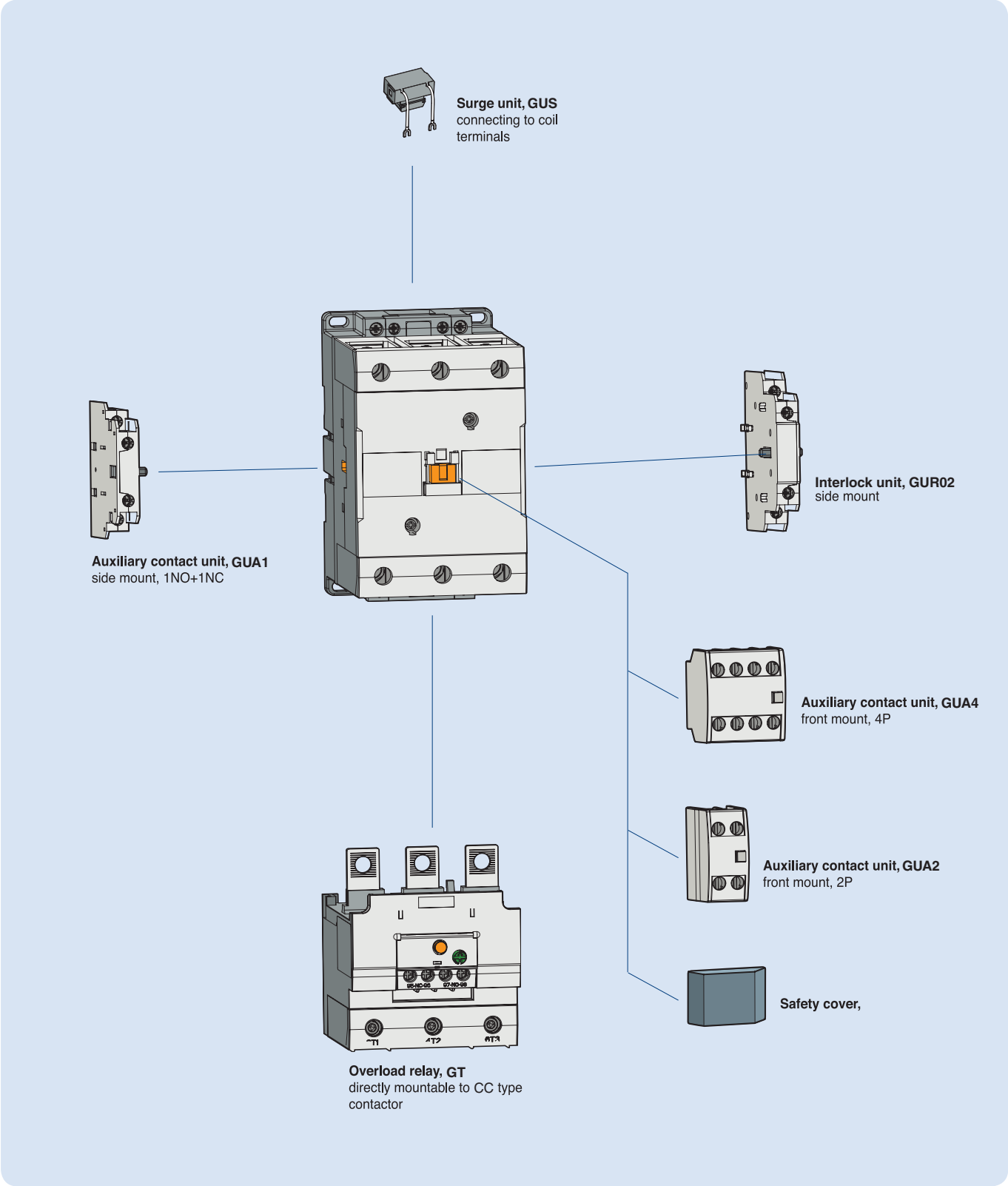

# Contactors (150AF ~ 800AF)

**CC130 ~ CC150**  
2NO2NC aux

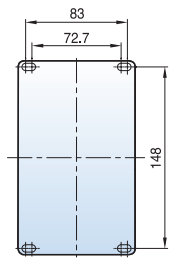
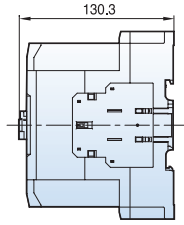
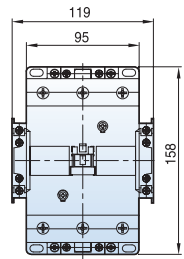

[mm]

2.4kg

**CC185 ~ CC225**  
2NO2NC aux

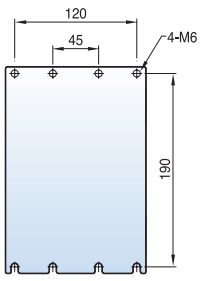
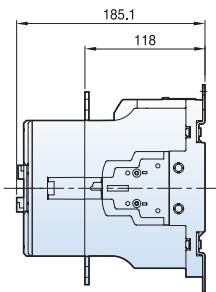
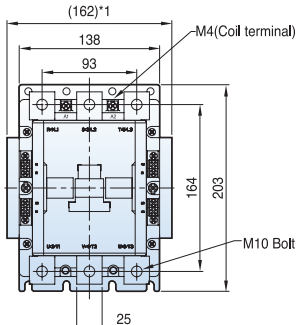

5.4kg

**CC265 ~ CC400**  
2NO2NC aux

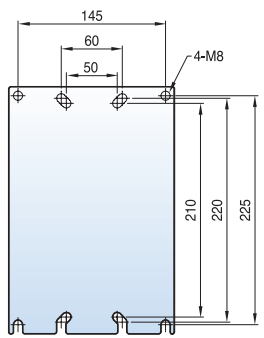
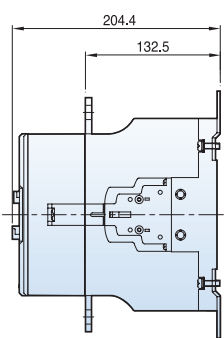
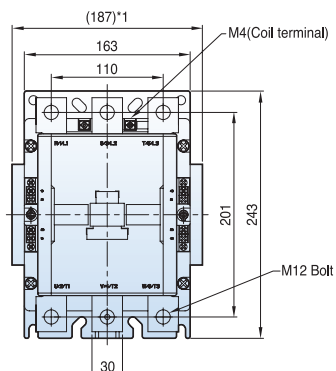

9.2kg

**CC500 ~ CC800**  
2NO2NC aux

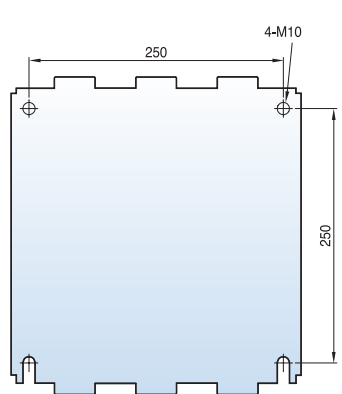
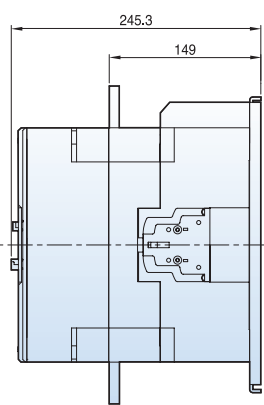
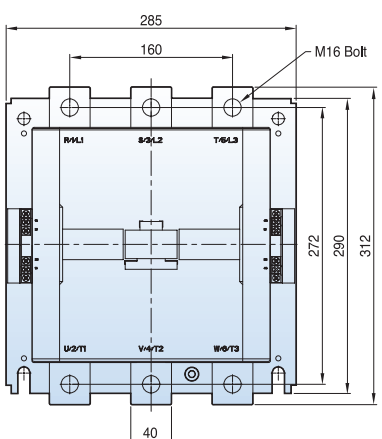

22.4kg

# Motor Starters (65AF ~ 150AF)

**CC50 ~ CC65  
with GT63  
shown with no  
aux contact**

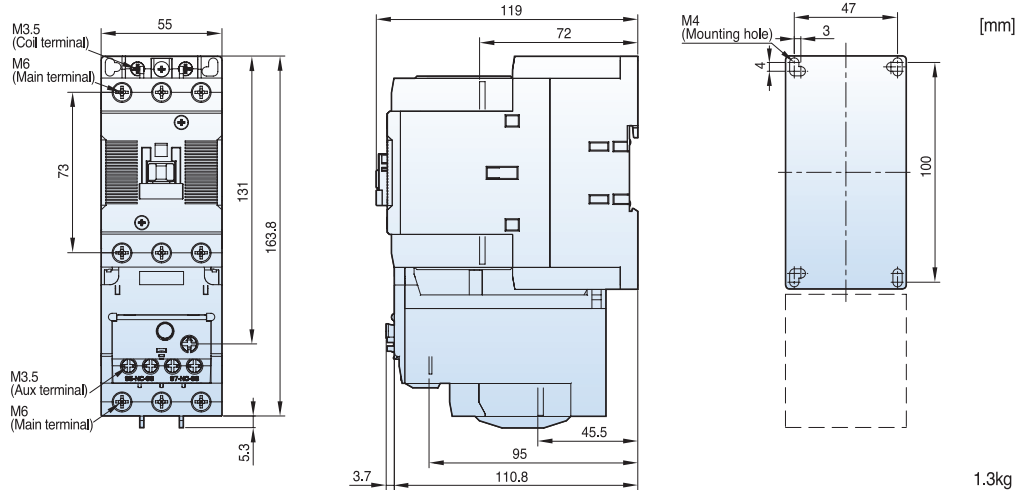

**CC75 ~ CC100  
with GT95  
shown with no  
aux contact**

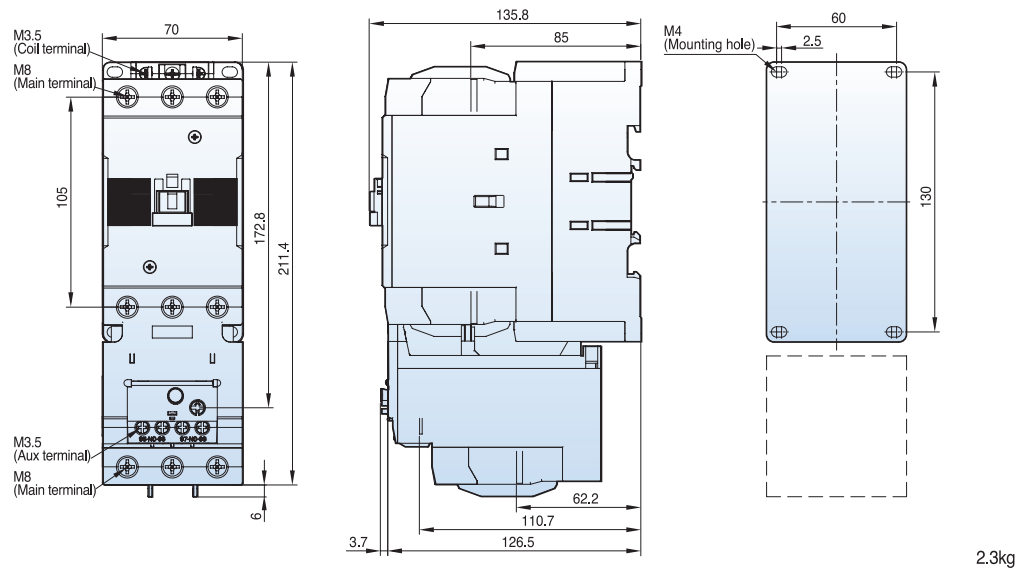

**CC130 ~ CC150  
with GT150  
shown with no  
aux contact**

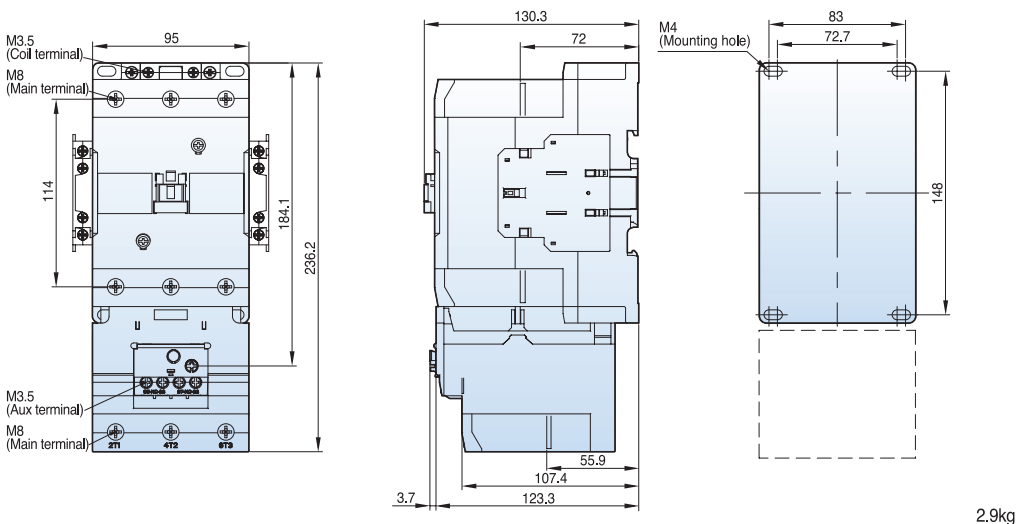

# Reversing Contactors and Starters (150AF ~ 800AF)

**CC130 ~ CC150**  
AC coil  
reversing combination  
shown with aux contacts

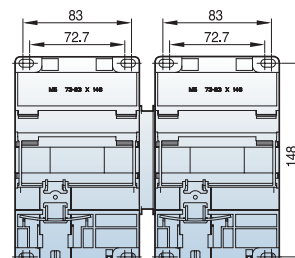
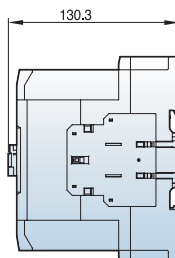
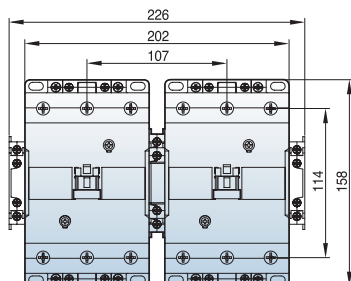

[mm]

4.3kg

**CC185 ~ CC225**  
reversing combination  
shown with aux contacts

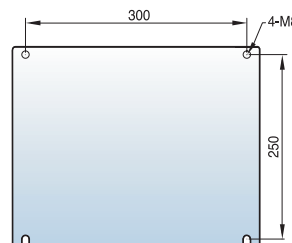
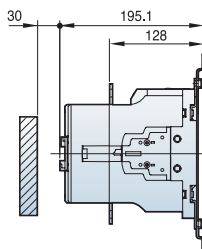
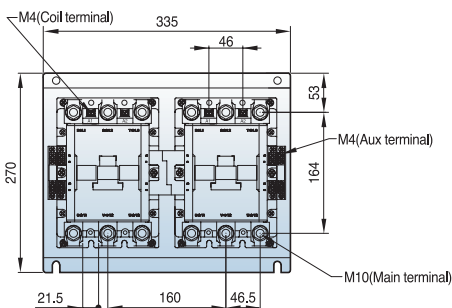

12.9kg

**CC265 ~ CC400**  
reversing combination  
shown with aux contacts

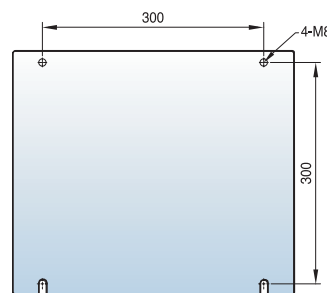
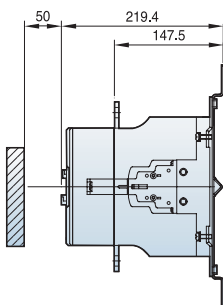
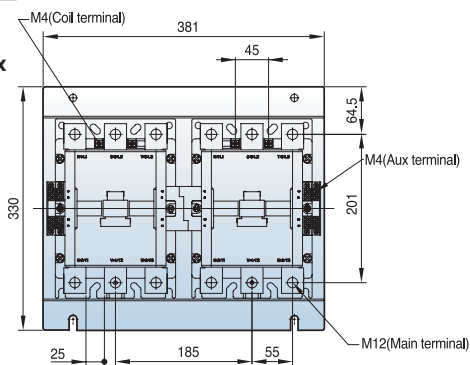

21.4kg

**CC500 ~ CC800**  
reversing combination  
shown with aux contacts

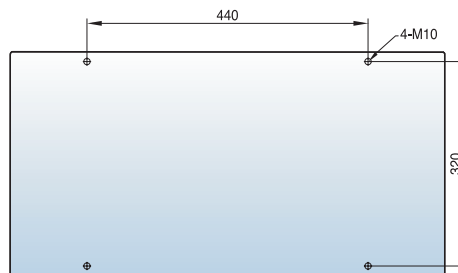
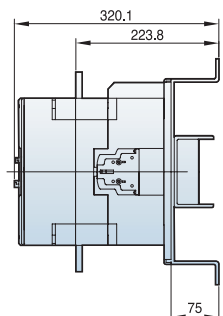
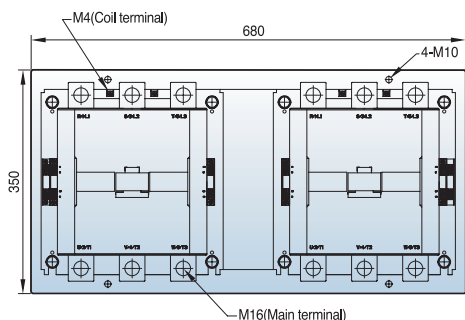

60kg