

Table of Specifications

Midi-Contactors



Frame size	
Type	Terminal type
Number of poles	
Rated operational voltage, Ue	
Rated insulation voltage, Ui	
Rated frequency	
Rated impulse withstand voltage, Uimp	
Maximum operating rate in operating cycles per hour(AC3)	
Durability	Mechanical
	Electrical
Current and power	AC-1, Thermal current A
	AC-3 200/240V kW
	380/440V kW
	500/550V kW
	690V kW
UL rating (50/60Hz)	Continuous current A
	Single phase 110~120V HP
	220~240V HP
	200~208V HP
	Three phase 220~240V HP
	440~480V HP
Size and weight	NEMA size
	Weight kg
Size and weight	Size(W × H × D) mm
	Weight kg
Auxiliary(standard)	Side mount
	Front mount



22AF			
CC9	CC12	CC18	CC22
Screw Only			
3pole			
690V			
690V			
50/60Hz			
6kV			
1800 operations per hour			
15 mil. operations			
2.5 mil. operations			
25	25	32	40
2.5	3.5	4.5	5.5
11	13	18	22
4	5.5	7.5	11
9	12	18	22
4	7.5	7.5	15
7	12	13	20
4	7.5	7.5	15
6	9	9	18
25	25	40	40
0.5	0.75	1	2
1.5	2	3	3
2	3	5	7.5
3	5	7.5	10
5	7.5	10	15
7.5	10	15	20
00	00	0	1
0.34			
45 × 73.5 × 86			
0.51			
45 × 73.5 × 117.7			
GUA1, GUA2, GUA4			
GUA-1			
GUA-2, GUA-4			

40AF	
CC32	CC40
Screw Only	
3pole	
690V	
1000V	
50/60Hz	
8kV	
1800 operations per hour	
12 mil. operations	
2 mil. operations	
50	60
7.5	11
32	40
15	18.5
32	40
18.5	22
28	32
18.5	22
20	23
50	60
2	3
5	7.5
7.5	15
10	15
20	30
25	30
1	1
0.55	
69 × 83 × 93	
0.77	
69 × 83 × 120	
GUA-1	
GUA-2, GUA-4	

Note) Minimum conduct current of Auxiliary contactor is DC 17V 5mA.

GT Type Thermal Overload Relays



Type	Screws clamp terminals
Rated operational voltage, Ue	
Rated insulation voltage, Ui	
Rated impulse withstand voltage, Uimp	
Trip class	
Setting range	
Size and weight	Weight kg
	Size(W × H × D) mm



GT32
690V
690V
6kV
10A, 20
0.1~40A
0.17
45 × 75 × 90

GT32
690V
690V
6kV
10A, 20
0.1~40A
0.17
45 × 75 × 90

Table of Specifications



65AF	
CC50	CC65
Screw or Lug	
3pole	
690V	
1000V	
50/60Hz	
8kV	
1800 operations per hour	
12 mil. operations	
2 mil. operations	
70	100
15	18,5
55	65
22	30
50	65
30	33
43	60
30	33
28	35
70	100
3	5
10	15
20	25
25	30
40	50
50	60
2	2
1.05	
79 × 106 × 122	
1.3	
79 × 106 × 149	

GUA-1
GUA-2, GUA-4



GT63
•
690V
690V
6kV
10A, 20
4~65A
0.31/0.33
55 × 81 × 100



100AF		
CC75	CC85	CC100
Screw or Lug		
3pole		
690V		
1000V		
50/60Hz		
8kV		
1800 operations per hour		
12 mil. operations		
2 mil. operations		
110	135	160
22	25	30
75	85	105
37	45	55
75	85	105
37	45	55
64	75	85
37	45	45
42	45	65
110	135	160
5	7.5	10
15	15	20
25	30	30
30	40	40
50	60	75
60	75	75
2	3	3
1.93		
94 × 140 × 137		
2.8		
94 × 140 × 174		

GUA-1
GUA-2, GUA-4



GT95
•
690V
690V
6kV
10A, 20
7~100A
0.48/0.5
70 × 97 × 110

Table of Specifications



400AF		
CC265*	CC330*	CC400*
Screw Only		
3pole		
690V		
1000V		
50/60Hz		
8kV		
1200 operations per hour		
5 mil. operations		2.5 mil. operations
1 mil. operations		0.5 mil. operations
300	350	450
80	90	125
265	330	400
147	160	200
265	330	400
147	160	225
225	280	350
160	200	250
185	225	300
300	350	450
-	-	-
-	-	-
75	100	125
100	125	150
200	250	300
200	250	300
5	5	5

9.2
163 × 243 × 198

2a2b		
-		
-		



GT400		
●		
690V		
690V		
6kV		
10A, 20		
85~400A		
2.6		
151 × 171 × 198		



800AF		
CC500*	CC630*	CC800*
Screw Only		
3pole		
690V		
1000V		
50/60Hz		
8kV		
1200 operations per hour		
2.5 mil. operations		0.5 mil. operations
580	660	900
147	190	220
500	630	800
265	330	440
500	630	800
265	330	500
400	500	720
300	400	500
380	420	630
580	660	900
-	-	-
-	-	-
150	200	200
200	250	300
400	500	600
400	500	600
6	6	7

22.4
285 × 312 × 242

2a2b		
-		
-		



GT800		
●		
690V		
690V		
6kV		
10A, 20		
200~800A		
11.5		
360 × 530 × 212		

Specifications are subject to change without notice.

Type Numbering System

Midi-Contactor

CC Magnetic 3-pole Midi-Contactor	9 Amperage Size	BLANK Type 3-pole /4-4-pole	S Terminal Type S - Screw L - Lug (>50A)	A Coil Type A - AC type D - DC type	120 Coil Voltage 24 - 24V 120 - 120V & 600 - 600V	BLANK AC Coil Frequency - 50/60 Hz 50Hz - 50Hz only 60Hz - 60Hz only	BLANK Auxiliary Contact s - standard arrangement NOAUX - no aux. contact (>=32A)
	9 - 9A 12 - 12A 18 - 18A 22 - 22A 32 - 32A 40 - 40A 50 - 50A 65 - 65A 75 - 75A 85 - 85A 100 - 100A						

Overload

GT Bimetallic Midi-Overload	32 Frame Size	BLANK Class class 10 L - class 20	S Terminal Type (Must match contactor number) S - Screw L - Lug (>35A)	0.16A Setting Ranges (Use upper limit in part)
	32 - 9, 12, 18A 22, 32, 40A 65 - 50, 65A 75 - 75, 85, 100A			0.1 ~ 0.16A 0.16 ~ 0.25A 0.25 ~ 0.4A 0.4 ~ 0.63A 0.63 ~ 1A 1 ~ 1.6A 1.6 ~ 2.5A 2.5 ~ 4A 4 ~ 6A 5 ~ 8A 6 ~ 9A 7 ~ 10A 9 ~ 13A 12 ~ 18A 16 ~ 22A 18 ~ 25A 22 ~ 32A 24 ~ 36A 28 ~ 40A 34 ~ 50A 45 ~ 65A 54 ~ 75A 63 ~ 85A 70 ~ 95A 80 ~ 100A (Setting Range Guide)
CGE Electronic Midi Overload	22 Frame Size	3P Protection Direct Mount 22 and 40AF 2P - 2-Pole 3P - 3-Pole 3PR - 3-pole Separate Mount All CGE sizes 2S - 2-Pole 3S - 3-Pole 3SR - 3-Pole	22A Setting Range (Use upper limit in part) CGE22 0.3 ~ 1.5A 1 ~ 5A 4.4 ~ 22A CGE40 4 ~ 20A 8 ~ 40A CGE80 16 ~ 80A	22 - 9, 12, 18, 22A 40 - 32, 40A 80 - 50, 65, 75, 85A
				Tunnel Type 22 and 40AF 2T - 2-Pole 3T - 3-Pole 3TR - 3-Pole

Optional Accessories

Auxiliary contact unit



Version	Contact composition
GUA1	Side mount
GUA2	Front mount(2P)
GUA4	Front mount(4P)
	11
	20
	02
	40
	31
	22
	13
	04

Surge absorber



Composition and voltage		
1	Varistor+RC	AC/DC 24~48V
2	Varistor+RC	AC/DC 100~125V
3	Varistor+RC	AC/DC 200~240V
4	Varistor+RC	AC 380~440V
5	Varistor+RC	AC 24~48V
6	Varistor+RC	AC 100~125V
11	Varistor	AC 200~240V
12	Varistor	DC 24~48V
13	Varistor	DC 100~125V
14	Varistor	DC 200~220V
22	RC	AC 100~125V

(Note) See page 52 for details.

Interlock unit



Contact composition

02	2NC
----	-----

Wire kit for Interlocking



Frame size

22	22AF
32	32AF
63	63AF
95	95AF

Separate mounting unit (For relay)



Frame size

32	32AF
63	63AF
95	95AF
150	150AF

Remote reset unit (For relay)



Cable length

16	400
20	500
24	600

Environment / Connections



Environment

Standards	IEC/EN 60947-1, IEC/EN 60947-4-1, UL508, K60947
Certifications	CE, UL
Rated insulation voltage (Ui)	1000V
Rated impulse withstand voltage (Uimp)	8kV
Degree of protection	IP20 (Conforming to IEC60529)
Ambient air temperature	Storage: -50° C ~ +80° C Operation: -5° C ~ +60° C
Operating altitude	3000m (8900ft)
Operating positions	
Shock resistance (1/2 sine wave =11ms)	Opened: 8G Closed: 10G
Vibration resistance (Conforming to IEC68-2-6) (5...300 Hz)	Opened: 2G Closed: 4G
Flame resistance	Conforming to UL 94: Vo Conforming to IEC 695-2-1: 960° C

Connections

Frame	Wire type	Main Terminal Size	Wire types						Torque	
			(AWG / mm ²)			mm(max)			[lb-in]	[Nm]
CC9		M4	18~10 / 1~6	18~10 / 1~6	18~10 / 1~6	9.6	20	2.25		
CC12			18~10 / 1~6	16~10 / 1~6	16~10 / 1~6					
CC18			18~10 / 1~6	16~8 / 1.5~10	16~8 / 1.5~10					
CC22		M5	18~10 / 1~6	14~8 / 2.5~10	14~8 / 2.5~10	12.8	35	4		
CC32			18~10 / 1~6	12~8 / 2.5~10	12~8 / 2.5~10					
CC40		M6	-	10~4 / 6~25	10~4 / 6~25	14	35	4		
CC50			-	8~3 / 10~35	8~3 / 10~35					
CC65			-	8~2 / 10~35	8~2 / 10~35					
CC75		M8	-	8~1/0 / 10~50	8~1/0 / 10~50	17	45	5.1		
CC85			-	8~2/0 / 10~70	8~2/0 / 10~70					
CC100		M8	-	3~2/0 / 35~70	3~2/0 / 35~70	24.5	80	9.1		
CC130			-	3~4/0 / 35~95	3~4/0 / 35~95					
CC150			-	-	-					
CC9~150		M4	20~14 / 0.5~2.5	18~12 / 0.75~2.5	18~12 / 0.75~2.5	7.6	15	1.75		
CC185		M10	-	1~4/0 / 50~95	1~4/0 / 50~95	25	130	14.7		
CC225			-	1/0~300 / 50~150	1/0~300 / 50~150					
CC265		M12	-	3/0~500 / 95~240	3/0~500 / 95~240	30	200	22.6		
CC330			-	4/0~500 / 95~240	4/0~500 / 95~240					
CC400		M16	-	350~700 / 185~185x2	350~700 / 185~185x2	40	500	26.5		
CC500			-	350~800 / 185~240x2	350~800 / 185~240x2					
CC630			-	600~2000	-					
CC800		-	-	1700~Busbar	-	-	-	-		
CC185~800		M4	20~14 / 0.5~2.5	18~12 / 0.75~2.5	18~12 / 0.75~2.5	7.6	15	1.75		

a data sheet and specify products, visit www.CarloGavazziOnline.com

Control Coil Characteristics



Frame size		22AF	40AF	65AF	100AF	150AF
Type		CC9	CC32	CC50	CC75	CC130
		CC12	CC40	CC65	CC85	CC150
		CC12			CC100	
		CC22				
AC coil						
Control voltage	[Uc]	24, 32, 36, 42, 48, 80, 100, 110, 220, 230, 240, 380, 400, 415, 440, 500, 550V				24, 48, 110,
	50Hz [V]	24, 48, 100, 110, 120, 200, 208, 220, 230, 240, 277, 380, 440, 480, 600V				220, 300,
	60Hz [V]	24, 48, 100, 110, 120, 200, 220, 230, 240, 380, 415, 440, 500, 550V				400, 500
Voltage limit	[Uc]					
	Pick-up	85 ~110% (50Hz)				
	Drop-out	85 ~110% (60Hz)				
Coil consumption at 20°C		30 ~ 60%				
	AC 220V Inrush [VA]	58/56	53/50	110/104	229/216	108/104
	50/60Hz Holding [VA]	9.0/6.0	12.0/9.0	13.0/10.0	17.0/13.0	18.0/21.0
Heat dissipation	[W]	2.1/1.5	2.7/2.2	2.8/2.4	5.4/4.7	2.7/3.6
Operating time						
	Closing [ms]	12 ... 22	12 ... 22	12 ... 22	15 ... 30	20 ... 40
	Opening [ms]	4 ... 19	4 ... 19	4 ... 19	10 ... 30	60 ... 70
DC coil						
Control voltage	[Uc]	12, 20, 24, 48, 60, 80, 100, 110, 125, 200, 220, 250				24, 48, 110, 220
Voltage limit	[Uc]					
	Pick-up	70 ~ 110%				
	Drop-out	10 ~ 30%				
Coil consumption at 20°C						
	DC 110V Inrush [W]	9	7	9	18	213
	Holding [W]	9	7	9	18	7.5
Time constant (L/R)	[ms]	28	28	65	75	
Operating time						
	Closing [ms]	35 ... 50	50 ... 65	50 ... 65	100 ... 120	70 ... 80
	Opening [ms]	4 ... 19	4 ... 19	4 ... 19	10 ... 25	60 ... 70

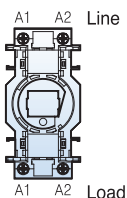

Note) A1(A2) in line side is internally connected to A1(A2) in load side.

To instantly view a data sheet and specify products, visit www.GavazziOnline.com

Control Coil Characteristics



Frame size	225AF	400AF	800AF
Type	CC185 CC225	CC265 CC330 CC400	CC500 CC630 CC800
AC/DC common coil			
Control voltage [Uc]			
AC/DC	24/24	-	-
AC/DC	48/48	-	100/100
AC/DC	100~240/100~220	100~240/100~220	200/200
AC	300	300	300
AC	400	400	400
AC	500	500	500
Voltage limit [Uc]			
Pick-up		86~110%	
Drop-out		30~60%	
Coil consumption at 20°C			
AC 220V Inrush [VA]	380	571	1000
50/60Hz Holding [VA]	11.6	14	29
Heat dissipation [W]	4.7	5	7.8
Operating time			
Closing [ms]	70	55	75
Opening [ms]	70	55	75

Internal Structure



Contactors (100AF)

Description

- 3-pole(NO) main contact
- Finger proof design
- DIN rail or screw mountable
- AC or DC control in different physical size
- Front/side mountable accessories available
- Direct mountable overload relay available Rating
- 2NO2NC Auxiliary contacts built-in as standard

Rating



CC100

Contactor type			CC75		CC85		CC100		
			kW	A	kW	A	kW	A	
AC duty	AC3	200/240V	22	75	25	85	30	105	
		380/440V	37	75	45	85	55	105	
		500/550 V	37	64	45	75	55	85	
		690V	37	42	45	45	45	65	
	AC4	200/240V	13	55	15	65	19	80	
		380/440V	25	52	30	62	37	75	
	AC1		-	110	-	135	-	160	
DC1 duty (L/R=1ms)	2-pole	24V	-	90	-	100	-	100	
		in series	48V	-	90	-	100	-	100
		110V	-	75	-	80	-	80	
	3-pole	24V	-	90	-	100	-	100	
		in series	48V	-	90	-	100	-	100
		110V	-	80	-	85	-	85	
DC2, 4 duty (L/R=15ms)	2-pole	24V	-	55	-	60	-	60	
		in series	48V	-	45	-	50	-	50
		110V	-	38	-	40	-	40	
	3-pole	24V	-	75	-	80	-	80	
		in series	48V	-	65	-	70	-	70
		110V	-	55	-	60	-	60	
Directly mountable Overload relay			GT95						
Conductor size (solid, stranded)	AWG		8~2		8~00		8~0		
	(the max. number of conducts: 2)	mm ²	10~35		10~50		10~70		
Conductor type			65/75°C Cu-wire only						



Coil Voltage

AC	50Hz	24, 32, 42, 48, 80, 100, 110, 220, 230, 240, 380, 400, 500, 550V
	60Hz	24, 48, 110, 110, 12, 200, 208, 220, 230, 240, 277, 380, 480, 600V
	50/60Hz	24, 48, 100, 110, 120, 200, 220, 230, 240, 380, 415, 440, 500, 550V
DC	DC	12, 20, 24, 48, 60, 80, 100, 110, 125, 200, 220, 250V

Certification

- CE(IEC)
- UL508

Contactors (100AF)

Accessories

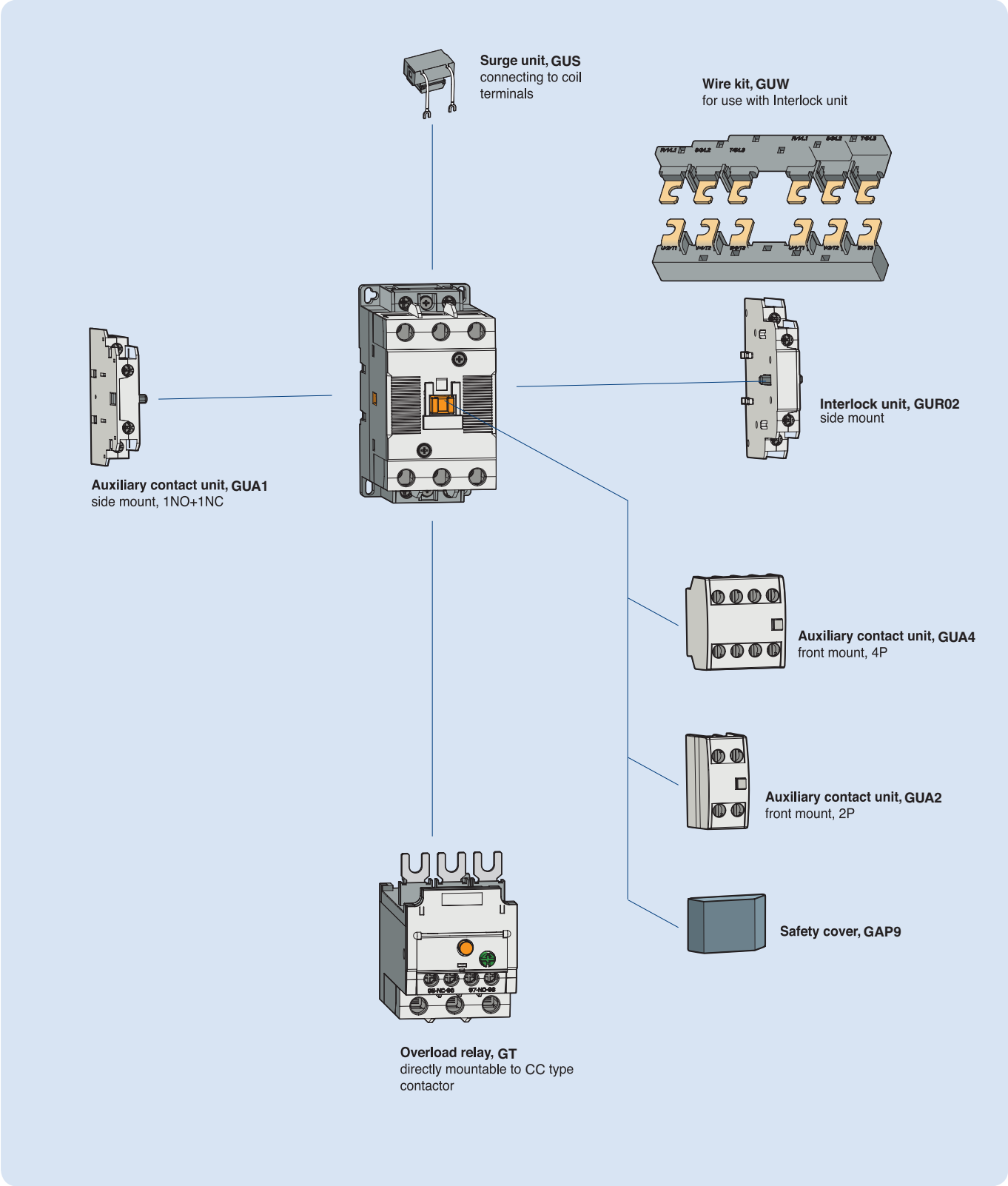

Specifications are subject to change without notice.

Rated Short Breaking Capacity of Installation

Manual Motor Starter	Adjustment Range (A)	Manual Motor Controller Group Installation			Applied Contactor (GC Series)	Applied Contactor (CC Series)
		Short Circuit Rating(KAIC)				
		240V	480Y/277V	600Y/347V		
32AF Rotary operation, standard interruption						
GMS-32H-0.16	0.1~0.16	100	65	25	GC9	CC9
GMS-32H-0.25	0.16~0.25	100	65	25	GC9	CC9
GMS-32H-0.4	0.25~0.4	100	65	25	GC9	CC9
GMS-32H-0.63	0.4~0.63	100	65	25	GC9	CC9
GMS-32H-1	0.63~1	100	65	25	GC9	CC9
GMS-32H-1.6	1~1.6	100	65	25	GC9	CC9
GMS-32H-2.5	1.6~2.5	100	65	25	GC12	CC12
GMS-32H-4	2.5~4	100	65	25	GC12	CC12
GMS-32H-6	4~6	100	65	25	GC18	CC18
GMS-32H-8	5~8	100	65	10	GC18	CC18
GMS-32H-10	6~10	100	65	10	GC18	CC18
GMS-32H-13	9~13	100	65	10	GC25	CC22
GMS-32H-17	11~17	100	30	10	GC25	CC22
GMS-32H-22	14~22	100	30	10	GC25	CC22
GMS-32H-26	18~26	100	30	10	GC32	CC32
GMS-32H-32	22~32	100	30	10	GC32	CC32
63AF Rotary operation, standard interruption						
GMS-63S-10	6~10	100	50	10	GC35	CC50
GMS-63S-13	9~13	100	50	10	GC35	CC50
GMS-63S-17	11~17	100	40	10	GC35	CC50
GMS-63S-22	14~22	100	40	10	GC35	CC50
GMS-63S-26	18~26	100	40	10	GC35	CC50
GMS-63S-32	22~32	100	40	10	GC35	CC50
GMS-63S-40	28~40	100	40	10	GC40	CC50
GMS-63S-50	34~50	100	40	10	GC50	CC50
GMS-63S-63	45~63	100	40	10	GC63	CC65
GMS-63S-65	47~65	100	40	10	—	CC65
63AF Rotary operation, High interruption						
GMS-63H-10	6~10	100	65	25	GC35	CC50
GMS-63H-13	9~13	100	65	25	GC35	CC50
GMS-63H-17	11~17	100	50	10	GC35	CC50
GMS-63H-22	14~22	100	50	10	GC35	CC50
GMS-63H-26	18~26	100	50	10	GC35	CC50
GMS-63H-32	22~32	100	50	10	GC35	CC50
GMS-63H-40	28~40	100	50	10	GC40	CC50
GMS-63H-50	34~50	100	50	10	GC50	CC50
GMS-63H-63	45~63	100	50	10	GC63	CC65
GMS-63H-65	47~65	100	40	10	—	CC65
100AF Rotary operation, Standard interruption						
GMS-100S-17	11~17	100	50	10	GC65	CC75
GMS-100S-22	14~22	100	50	10	GC65	CC75
GMS-100S-26	18~26	100	50	10	GC65	CC75
GMS-100S-32	22~32	100	50	10	GC65	CC75
GMS-100S-40	28~40	100	50	10	GC65	CC75
GMS-100S-50	34~50	100	50	10	GC65	CC75
GMS-100S-63	45~63	100	40	10	GC65	CC75
GMS-100S-75	55~75	100	40	10	GC75	CC75
GMS-100S-90	70~90	100	40	10	GC85	CC85
GMS-100S-100	80~100	100	40	10	GC95	CC100
100AF Rotary operation, High interruption						
GMS-100H-17	11~17	100	65	25	GC65	CC75
GMS-100H-22	14~22	100	65	20	GC65	CC75
GMS-100H-26	18~26	100	65	20	GC65	CC75
GMS-100H-32	22~32	100	65	20	GC65	CC75
GMS-100H-40	28~40	100	65	20	GC65	CC75
GMS-100H-50	34~50	100	65	20	GC65	CC75
GMS-100H-63	45~63	100	50	10	GC65	CC75
GMS-100H-75	55~75	100	50	10	GC75	CC75
GMS-100H-90	70~90	100	50	10	GC85	CC85
GMS-100H-100	80~100	100	50	10	GC95	CC100

Specifications are subject to change without notice.

Contactors (100AF)

CC75 ~ CC100
AC coil
2NO2NC aux

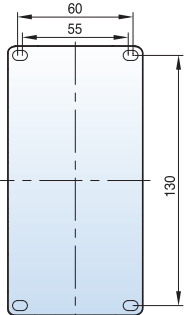
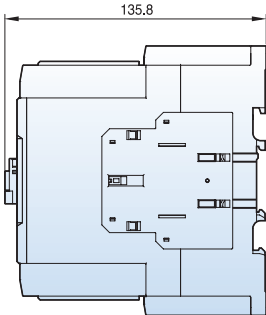
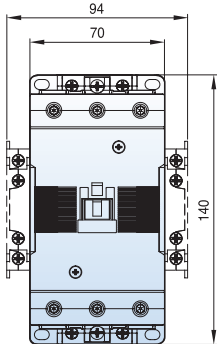

[mm]

1.9kg

CC75 ~ CC100
DC coil
2NO2NC aux

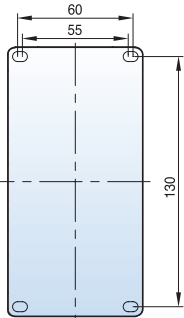
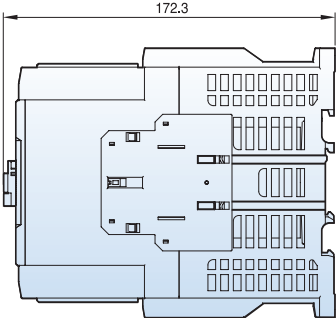
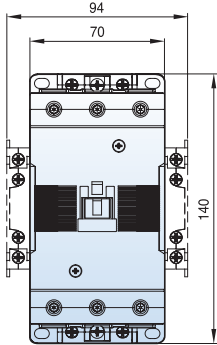

2.8kg

Motor Starters (65AF ~ 150AF)

**CC50 ~ CC65
with GT63
shown with no
aux contact**

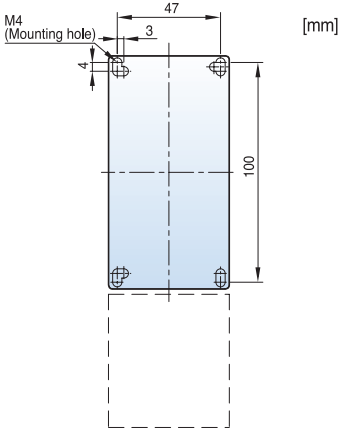
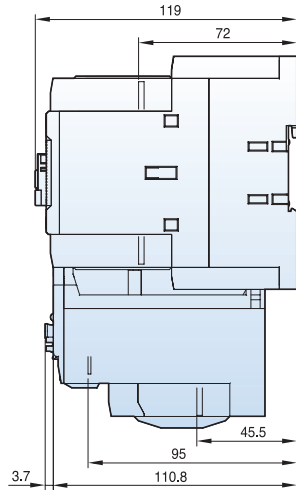
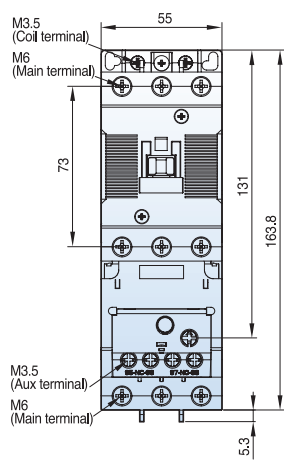

1.3kg

**CC75 ~ CC100
with GT95
shown with no
aux contact**

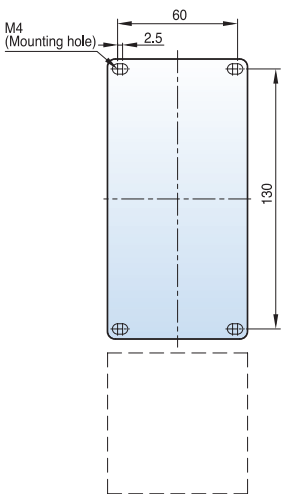
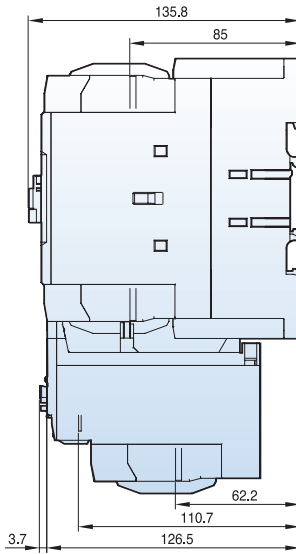
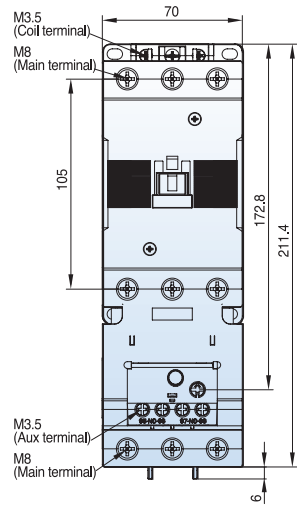

2.3kg

**CC130 ~ CC150
with GT150
shown with no
aux contact**

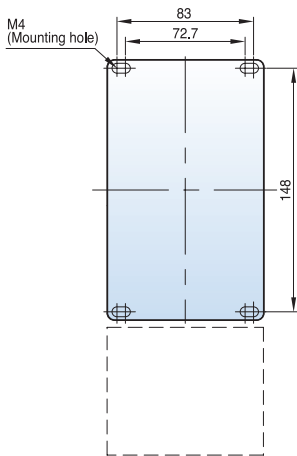
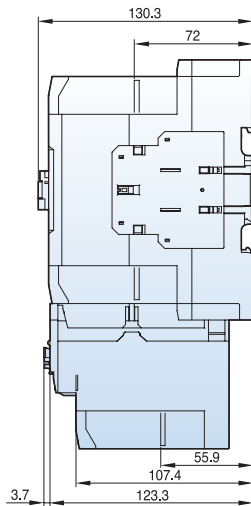
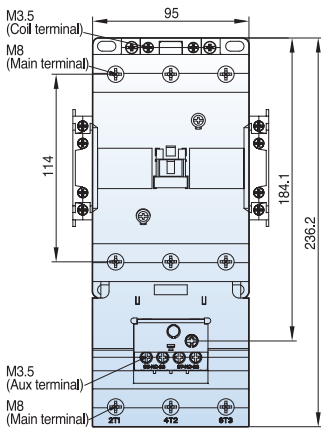

2.9kg