



**Catalog symbols for 30, 60 and 100 A switches**

Symbol	Description
CCP2-(pole)-(amps)CF	Switch only
CCP2R-(pole)-(amps)CF	Right front rotary, clockwise operated switch
CCP2RL-(pole)-(amps)CF	Left front rotary, clockwise operated switch
CCP2S-(pole)-(amps)CF	Right side rotary, clockwise operated switch
CCP2SL-(pole)-(amps)CF	Left side rotary, counterclockwise operated switch

**Description**

The revolutionary, next generation Bussmann™ series Compact Circuit Protector (cat. no. CCP2) is a fused UL® 98 branch circuit disconnect switch utilizing the UL Class CF time-delay or fast-acting CUBEFuse™ with Class J electrical performance. With up to a 51 percent smaller footprint than a traditional fusible solution, these switches provide a high 200 kA SCCR to help improve panel and assembly SCCR.

The 35 mm DIN-Rail mount CCP2 is available in a variety of 30, 60 and 100 amp configurations to meet many application needs including rotary operation.

The switch-only versions of the 30, 60 and 100 A disconnects are direct, drop-in replacements for the earlier models (noted by a catalog number starting “CCP-”). The auxiliary contacts are backwards compatible. The multi-wire lug kits and terminal shrouds are not.

Application flexibility is extended with an optional multi-wire lug kit, featuring finger-safe shrouds, that provides three (30 and 60 A switches) and six (100 A switches) additional wire ports on each pole for power distribution applications.

Other accessories include a NO/NC auxiliary contacts that easily integrate into various monitoring systems.

Front and side rotary operated versions are easily applied for through-the-door or through the left or right side operation to enhance safety.

**Ratings**

- Volts
  - 347 Vac (1-pole switches)
  - 600 Vac (2- and 3-pole switches)
  - 125 Vdc\*
- Amps
  - 30 A
  - 60 A
  - 100 A
- SCCR
  - 200 kA RMS Sym.
  - 100 kA DC

**Poles**

- 1-, 2- and 3-poles catalog number dependent

\* Switch amp rating and installed fuse amp rating dependent, see catalog number table for details.

**Agency information**

- UL 98 Listed, Guide WHTY, File E302370
- cULus to Canadian Standard 22.2 No. 4-04, Guide WHTY7, File E302370
- CSA Certified, C22.2 No. 4, Class 4651-02, File 150484
- RoHS compliant
- CE

**Conductors/terminals**

- 75°C Cu, see conductor tables for size, type and torque information
- Box lug, single/dual conductor
- Fork terminal suitable for line, load or accessory connection, max. 30 A suitable for use with:
  - 10-24 screw for 30 and 60 A switches
  - 1/4-28 screw for 100 A switches
- Multi-wire lug kits — see accessories for details

**Storage and operating temperature**

- 20°C to 75°C (-4°F to 167°F)\*

\* For fuse performance under or above 25°C, consult fuse performance derating charts in the Bussmann Division publication no. 3002, titled Selecting Protective Devices (SPD)

**Lockout/tagout provisions**

- 1/4" lock, direct use on switches without rotary mechanisms requires a lock with a straight shank of sufficient length to engage all poles

**Minimum enclosure size per UL 98\***

- 30 and 60 A switch 10" x 8" x 6" (254 x 203 x 152 mm)
- 100 A switch, 12" x 10" x 6" (305 x 254 x 152 mm)

\* Smaller enclosures may be used at the discretion of the user, with adherence to NEC minimum wire bend radius requirements.

**Mounting\*\***

- 35 mm DIN-Rail
- Mounting foot bracket (Catalog no. CCP2-MT-KIT)

\*\*Switch is panel mount with flange handle cable operator.

**Local open fuse indication minimum voltage**

- 90 Vac, requires an open fuse to be in the CCP2 and the switch in the ON position

**Accessories**

- Multi-wire lug kits with terminal shrouds
- Selector and pistol handles for use with rotary operated switches
- 8 mm shafts for use with selector and pistol handles
- Auxiliary contacts
- NFPA 79 compliant handle
- Flange handle rod and cable operators

**Carton quantity and shipping weight**

Item	Poles	Qty.	Weight lb (kg)
<b>30 and 60 amp switches</b>			
Switch only	1-pole	12	3.8 (1.7)
Switch with side rotary mechanism	2-pole	1	1.3 (0.6)
	3-pole	1	1.6 (0.7)
Switch with front rotary mechanism	2-pole	1	1.3 (0.6)
	3-pole	1	1.6 (0.7)
<b>100 amp switches</b>			
Switch only	1-pole	6	3.1 (1.4)
Switch with side rotary mechanism	2-pole	1	1.7 (0.8)
	3-pole	1	2.3 (1.0)
Switch with front rotary mechanism	2-pole	1	1.7 (0.8)
	3-pole	1	2.3 (1.0)

**Features**

- Uses UL Class CF time-delay or fast-acting CUBEFuse with Class J electrical performance
- Extremely compact design at 25.4 mm (1 inch) wide per pole
- Amp rating rejection disconnects will not accept a CUBEFuse amp rating greater than switch rating
- High 200 kA short-circuit current rating
- Disconnect rated to provide means for load isolation
- Full voltage rated at 347 Vac (1-pole switches) and 600 Vac (2- and 3-pole switches)
- 125 Vdc\* rated to meet specialized applications
- UL 98 Listed and suitable for branch circuit disconnect and branch circuit protection with installed fuses
- Horsepower rated
- Open fuse indication:
  - Local open fuse indication light standard on each pole
  - Additional open fuse indication can be provided by the indicating time-delay CUBEFuse (6 to 100 A)
- Finger-safe construction with 10 AWG (6 mm<sup>2</sup>) wire or larger
- Built-in switch interlock prohibits removing or installing the fuse while in the ON position
- Padlockable for lockout/tagout procedures with a 1/4" lock
  - Rotary operated versions provide for through-the-door and through-the-side operation flexibility and enhanced safety with:
    - Right or left front operation
    - Right or left side operation
- Optional selector and pistol handles, and shafts available for use with rotary operated versions
- Multi-wire lug kits with terminal shrouds allow for power distribution to multiple loads. Each lug has three (30, 60, and 100 A switches) or six (100 A switches) ports rated for single and dual wires (see lug kits in accessories for details).

\* Switch amp rating and installed fuse amp rating dependent, see catalog number table for details.

**Rotary operating versions**



**Left front**

Uses clockwise handles



**Right front**

Uses clockwise handles



**Left side**

Uses counterclockwise handles



**Right side**

Uses clockwise handles

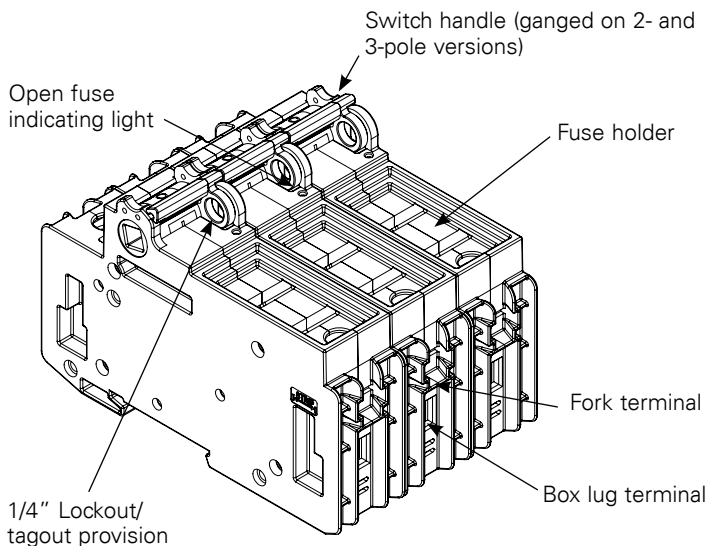

**30, 60 and 100 A switch catalog numbers**

Catalog no.	Poles	Description/switch operation	Volts	SCCR	Max Hp rating (Vac)			
					120	240	480	600
<b>30 amp switches</b>								
CCP2-1-30CF	1		347 Vac/125 Vdc		1-1/2	—	—	—
CCP2-2-30CF	2	Switch only	600 Vac/125 Vdc		—	3	—	—
CCP2-3-30CF	3		600 Vac		—	5	15	10
CCP2R-2-30CF	2	Right front rotary, clockwise	600 Vac/125 Vdc	200 kA AC	—	3	—	—
CCP2R-3-30CF	3		600 Vac		—	5	15	10
CCP2RL-2-30CF	2	Left front rotary, clockwise	600 Vac/125 Vdc	100 kA DC	—	3	—	—
CCP2RL-3-30CF	3		600 Vac		—	5	15	10
CCP2S-2-30CF	2	Right side rotary, clockwise	600 Vac/125 Vdc		—	3	—	—
CCP2S-3-30CF	3		600 Vac		—	5	15	10
CCP2SL-2-30CF	2	Left side rotary, counterclockwise	600 Vac/125 Vdc		—	3	—	—
CCP2SL-3-30CF	3		600 Vac		—	5	15	10
<b>60 amp switches</b>								
CCP2-1-60CF	1		347 Vac/125 Vdc*		3	—	—	—
CCP2-2-60CF	2	Switch only	600 Vac/125 Vdc*		—	7-1/2	—	—
CCP2-3-60CF	3		600 Vac		—	7-1/2	20	10
CCP2R-2-60CF	2	Right front rotary, clockwise	600 Vac/125 Vdc*	200 kA AC	—	7-1/2	—	—
CCP2R-3-60CF	3		600 Vac		—	7-1/2	20	10
CCP2RL-2-60CF	2	Left front rotary, clockwise	600 Vac/125 Vdc*	100 kA DC	—	7-1/2	—	—
CCP2RL-3-60CF	3		600 Vac		—	7-1/2	20	10
CCP2S-2-60CF	2	Right side rotary, clockwise	600 Vac/125 Vdc*		—	7-1/2	—	—
CCP2S-3-60CF	3		600 Vac		—	7-1/2	20	10
CCP2SL-2-60CF	2	Left side rotary, counterclockwise	600 Vac/125 Vdc*		—	7-1/2	—	—
CCP2SL-3-60CF	3		600 Vac		—	7-1/2	20	10
<b>100 amp switches</b>								
CCP2-1-100CF	1		347 Vac/125 Vdc**		5	—	—	—
CCP2-2-100CF	2	Switch only	600 Vac/125 Vdc**		—	10	—	—
CCP2-3-100CF	3		600 Vac		—	20	50	40
CCP2R-2-100CF	2	Right front rotary, clockwise	600 Vac/125 Vdc**	200 kA AC	—	10	—	—
CCP2R-3-100CF	3		600 Vac		—	20	50	40
CCP2RL-2-100CF	2	Left front rotary, clockwise	600 Vac/125 Vdc**	100 kA DC	—	10	—	—
CCP2RL-3-100CF	3		600 Vac		—	20	50	40
CCP2S-2-100CF	2	Right side rotary, clockwise	600 Vac/125 Vdc**		—	10	—	—
CCP2S-3-100CF	3		600 Vac		—	20	50	40
CCP2SL-2-100CF	2	Left side rotary, counterclockwise	600 Vac/125 Vdc**		—	10	—	—
CCP2SL-3-100CF	3		600 Vac		—	20	50	40

\* 125 Vdc for installed fuse amp ratings up to 40 A, 24 Vdc for installed fuse amp ratings from 45 to 60 A.  
\*\* 125 Vdc for installed fuse amp ratings up to 80 A, 24 Vdc for installed fuse amp ratings from 90 to 100 A.

100 A and below Flange operators (not compatible with units with mechanisms already installed)  
CCP2-FLC1-xxx Flange cable operator (36, 36X, 60, 60X, 120 and 120X)  
CCP2-FLR1-xxx Flange rod operator (21 and 21X)

**Box lug terminal conductor data**

Wire type	AWG range	Class	Quantity	Torque N·m (lb-in)		
<b>30 and 60 A switches</b>						
75°C Cu	4-6	Stranded, Class B to K	Single	3.95 (35)		
	8-18			2.26 (20)		
	6-8	Stranded, Class B/C	Dual	3.39 (30)		
				Stranded, Class K	2.26 (20)	
	10-18	Stranded, Class B to K	Single/dual		2.26 (20)	
	10-18			Solid	2.26 (20)	
	75°C Cu	4-18	Stranded, UL ferrule, Class B/C	Single	3.39 (30)	
		6-18			Twin†	2.82 (25)
4-18		Stranded, UL ferrule, Class K	Single	2.82 (25)		
6-18				Twin†	2.82 (25)	
<b>100 A switches</b>						
75°C Cu		12-18	Stranded, Class B/C	Single	2.26 (20)	
		10			2.82 (25)	
		8			4.52 (40)	
	4-6	5.08 (45)				
	1-3	6.21 (55)				
	4-12	Dual			5.08 (45)	
	12-18	2.26 (20)				
	10	3.95 (35)				
	1-8	Stranded, UL ferrule, Class B/C			Single	4.52 (40)
	10-18					Twin†
	6-9	Solid			Single/Dual	2.82 (25)
	10-18					2.26 (20)
	8-18	Class K			Single	2.26 (20)
	1-7					3.39 (30)
3-10	Dual	Dual	5.08 (45)			
8-18			2.26 (20)			
1-7	Class K, UL ferrule	Single	3.39 (30)			
6-18			Twin	2.26 (20)		

† Two stranded conductors placed in one UL Listed twin ferrule.

**Lineside and loadside fork terminal**

- Fork terminal suitable for line, load or accessory connection, max. 30 A suitable for use with:
  - 10-24 screw for 30 and 60 A switches

**Available Bussmann series fuses**

UL fuse class	Type/description	Volts	Data sheet no.
CF	Indicating time-delay, Low-Peak™ CUBEFuse (6-100 A)	600 Vac/ 300 Vdc	9000
	Non-indicating time-delay, Low-Peak CUBEFuse (1-100 A)		
	Non-indicating fast-acting CUBEFuse (1-100 A)	600 Vac/dc	2147

**Dimensions – mm (in)**

Switch (shown with optional terminal shrouds)

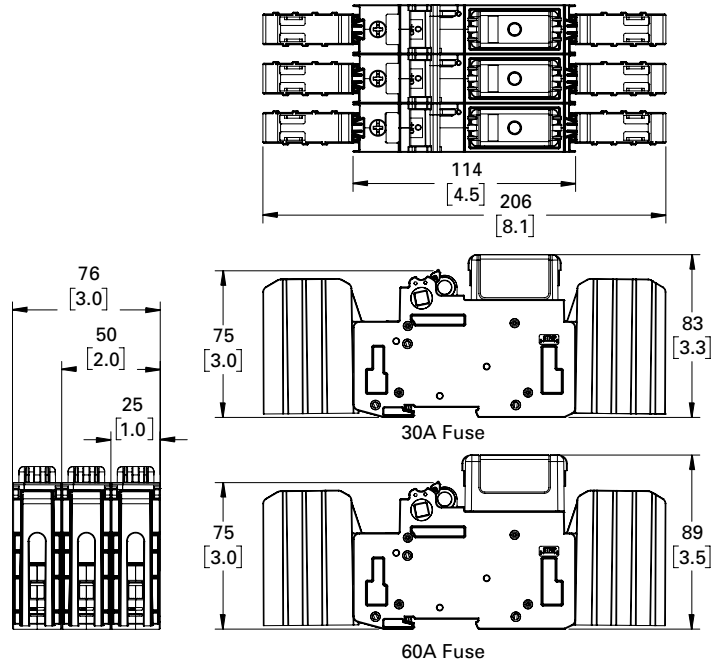

**30 and 60 amp switches**

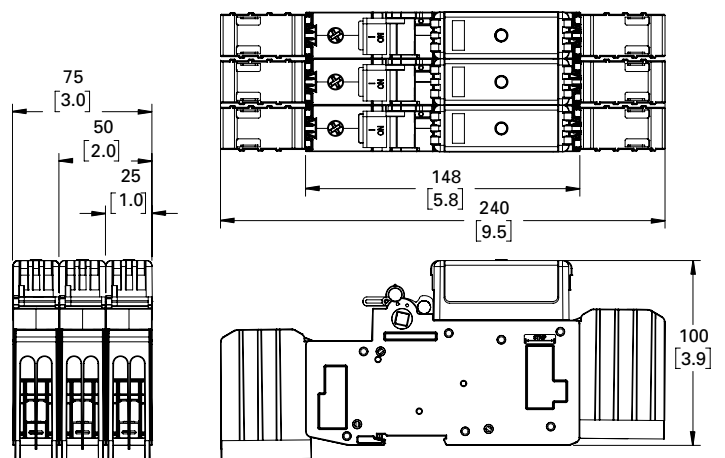

**100 amp switches**

**Left front rotary switches** (shown with optional terminal shrouds)

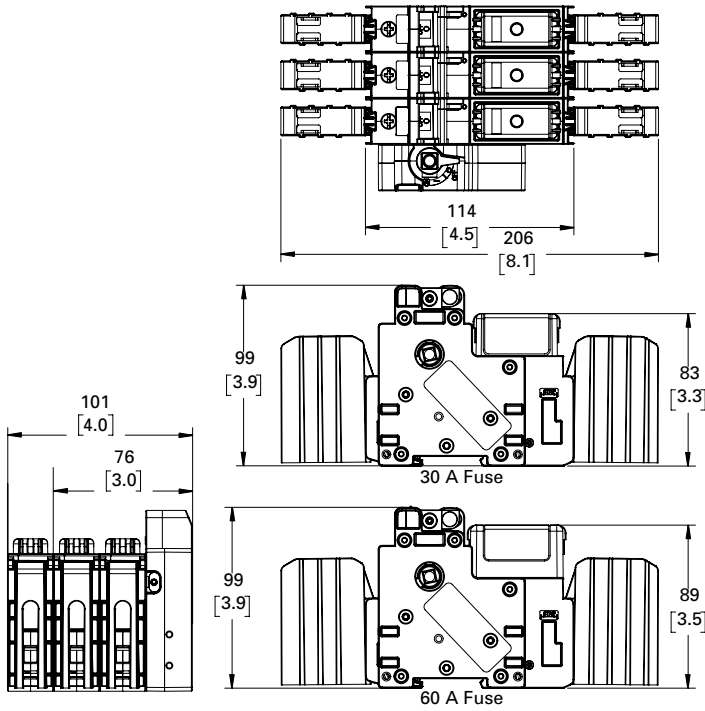

**30 and 60 amp switches**

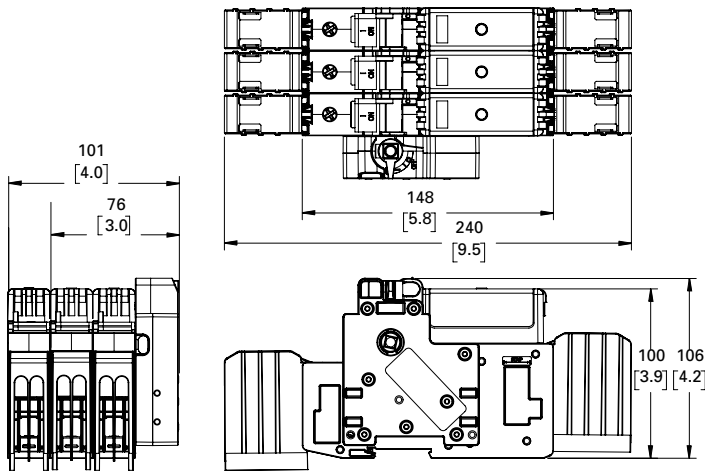

**100 amp switches**

**Right front rotary switches** (shown with optional terminal shrouds)

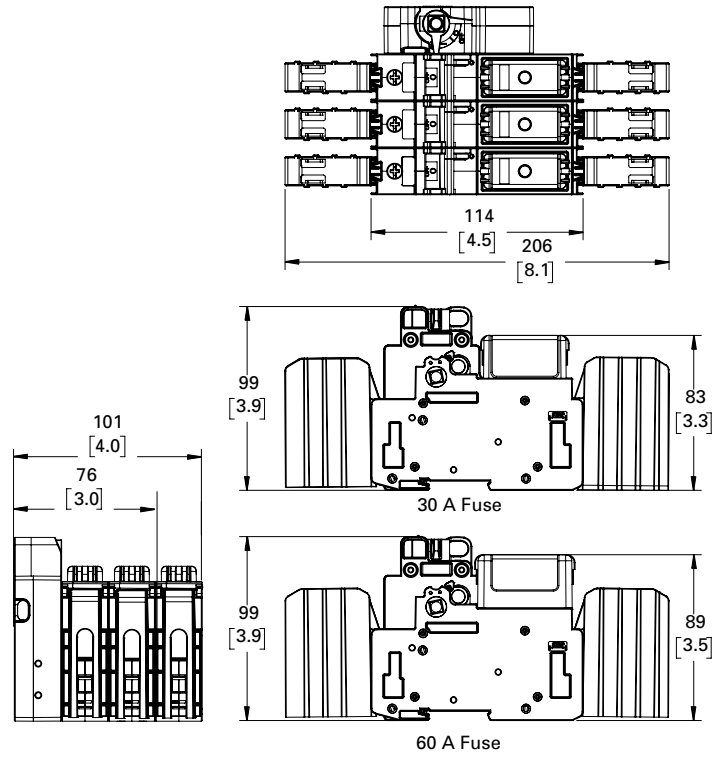

**30 and 60 amp switches**

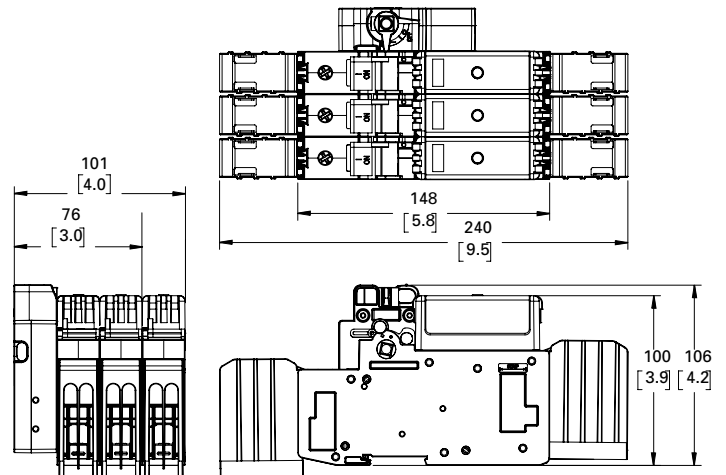

**100 amp switches**

**Left side rotary switches** (shown with optional terminal shrouds)

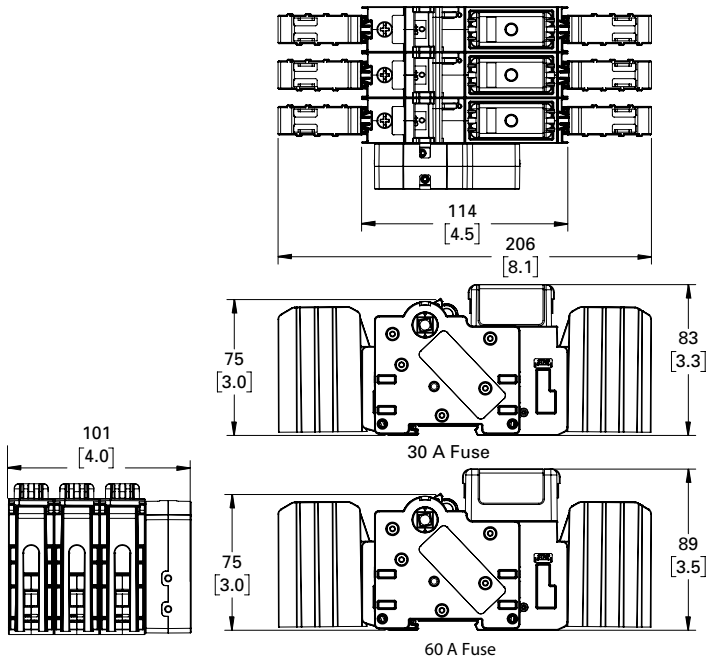

**30 and 60 amp switches**

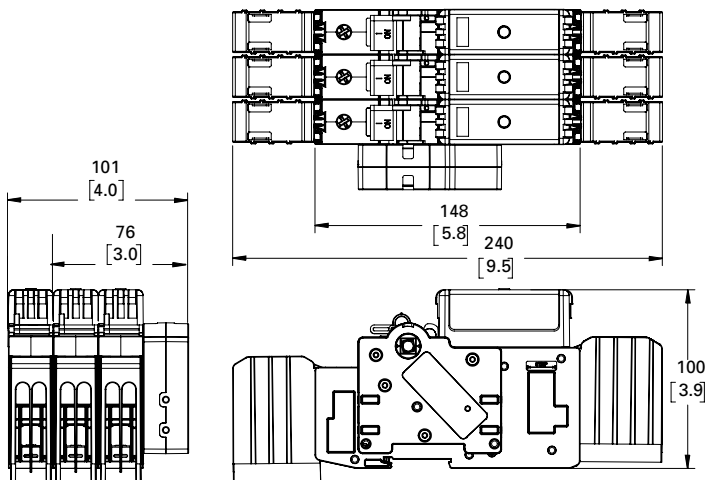

**100 amp switches**



**Right side rotary switches** (shown with optional terminal shrouds)

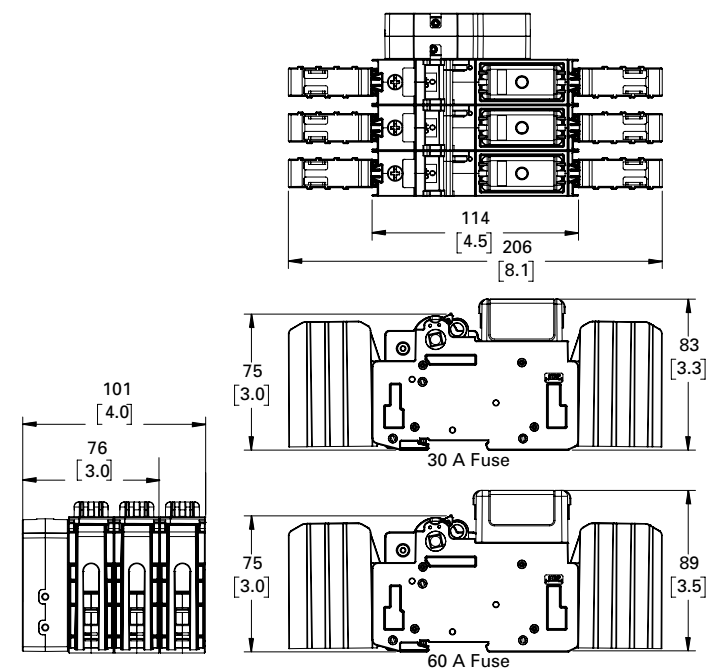

**30 and 60 amp switches**

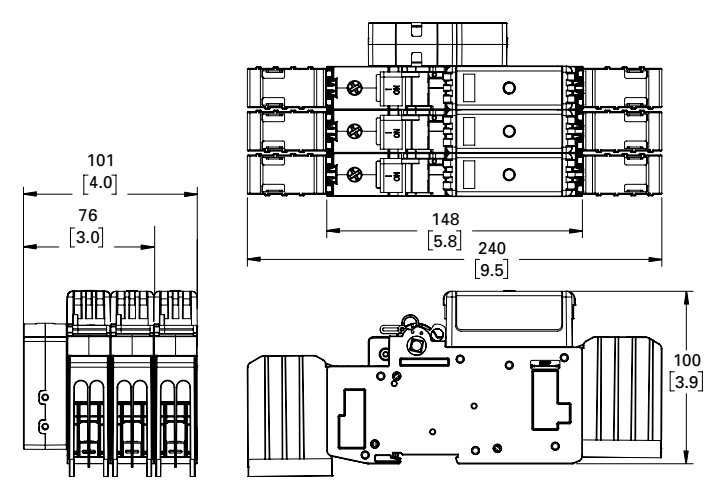

**100 amp switches**

**200 and 400 A switches**



200 A switch



400 A switch



With front rotary accessory



With side rotary accessory

Catalog no.	Poles	Amps	Description
CCP2-1-200CF	1		Switch only
CCP2-2-200CF	2	200	
CCP2-3-200CF	3		
CCP2-1-400CF	1		Switch only
CCP2-2-400CF	2	400	
CCP2-3-400CF	3		

**Description**

The Bussmann series 200 and 400 A Compact Circuit Protector (CCP2) fused disconnect switches utilize the finger-safe UL Class CF time-delay CUBEFuse with Class J electrical performance. With up to a 69 percent smaller footprint than a traditional fusible solution, these switches provide a high 200 kA SCCR to help improve panel and assembly SCCR.

The panel mount 200 and 400 A CCP2 switches are available with a variety of accessories to meet many application needs including rotary and flange handle operation.

Rotary operators are available for front or side (right or left) operation. Front rotary operators are for three-pole switches only while the side operator may be applied to the right or left side of 1-, 2- and 3-pole units.

Other accessories include lugs, terminal shrouds, rotary pistol handles, flange rod and cable operating mechanisms, NO/NC auxiliary contacts that easily integrate into various monitoring systems and a handle extension.

Front and side rotary operated versions are easily applied for through-the-door or through the left or right side operation to enhance safety.

**Ratings**

- Volts
  - 347 Vac (1-pole) 600 Vac (2- and 3-pole)
- Amps
  - 200 A
  - 400 A
- SCCR
  - 200 kA RMS Sym.

**Poles**

- 1-, 2- and 3-poles catalog number dependent

**Agency information**

- UL 98 Listed, Guide WHTY, File E302370
- cULus to Canadian Standard 22.2 No. 4-04, Guide WHTY7, File E302370
- CSA Certified, C22.2 No. 4, Class 4651-02, File 150484
- RoHS compliant
- CE

**Conductors/terminals**

- See available lug table for size, type and torque information

**Storage and operating temperature**

- -20°C to 75°C (-4°F to 167°F)\*

\* For fuse performance under or above 25°C, consult fuse performance derating charts in the Bussmann Division publication no. 3002, titled Selecting Protective Devices (SPD)

**Lockout/tagout provisions using 1/4" lock**

- Integral with switch handle
- Front rotary operating mechanism
- Rotary pistol handles
- Flange rod and cable operators

**Minimum enclosure size**

- 200 A switch 16 x 12 x 6" (405 x 305 x 150 mm)
- 400 A switch 24 x 16 x 8 (610 x 405 x 200 mm)

**Mounting**

- Panel mount

**Local open fuse indication minimum voltage**

- 90 Vac, requires an open fuse to be in the CCP2 and the switch in the ON position

**Accessories**

- Lugs and lug kits with terminal shrouds
- Pistol handles for use with rotary operated switches
- NFPA 79 compliant handle
- 12 mm shafts for use with selector and pistol handles
- Auxiliary contacts
- Flange handle rod and cable operators

**Carton quantity**

Item	Poles	Qty.
<b>200 amp switches</b>	1	1
	2	1
	3	1
<b>400 amp switches</b>	1	1
	2	1
	3	1



**Features**

- Uses UL Class CF time-delay CUBEFuse with Class J electrical performance
- Amp rating rejection feature will not accept a CUBEFuse amp ratings greater than switch rating
- High 200 kA short-circuit current rating
- Disconnect rated to provide means for load isolation
- Full voltage rated at 600 Vac
- UL 98 Listed and suitable for branch circuit disconnect and branch circuit protection with installed fuses
- Horsepower rated (see table below)

- Standard local open fuse indication light on each pole speeds troubleshooting
- Built-in switch interlock prevents inserting or removing fuse while in the ON position
- Padlockable for lockout/tagout procedures with a 1/4" lock
- Front and side rotary operator accessories provide for through-the-door and through-the-side operation flexibility and enhanced safety
- Optional pistol handles and shafts available for use with rotary operator accessories
- Multi-wire lug kits with terminal shrouds allow for power distribution to multiple loads.

**Catalog numbers and horsepower ratings**

Catalog no.	Poles	Description	Volts AC	SCCR	Max Hp rating (Vac)		
					240	480	600
<b>200 amp switches</b>							
CCP2-1-200CF	1	Switch only	347	200 kA	—	—	—
CCP2-2-200CF	2		600		15	—	—
CCP2-3-200CF	3		50		100	150	
<b>400 amp switches</b>							
CCP2-1-400CF	1	Switch only	347	200 kA	—	—	—
CCP2-2-400CF	2		600		15	—	—
CCP2-3-400CF	3		100		200	350	

**Available lugs, conductor ratings and terminal torques**

Catalog no.	Description	Lugs per cat. no.	Wire range AWG (mm <sup>2</sup> )	Wire type/ temp.	Conductor torque N·m (lb-in)	Lug mounting screw torque N·m (lb-in)
<b>200 A switches</b>						
CCP2-L2-1	Stainless steel lug	1	350-4 (185-25)	Cu 75°C	20.3 (180)	13.5 (120)
CCP2-L2-1A	Aluminum lug*	1	350-4 (185-25)	Cu/Al 75°C	28.2 (250)	13.5 (120)
CCP2-MW2-3	3-port multi-wire terminal with shroud*	3	2-14 (35-2.5)	Cu/Al 75°C	7.9 (70)	10.8 (95)
CCP2-MW2-6	6-port multi-wire terminal with shroud*	3	6-14 (16-2.5)	Cu/Al 75°C	2.8 (25)	10.8 (95)
* These lugs also accept 1/4" quick connect control wire terminals. Order catalog number CCP2-CWK2 (package of 12 terminals).						
<b>400 A Switches</b>						
CCP2-L4-1	Stainless steel lug	1	500-3 (240-35)	Cu 75°C	42.0 (375)	
CCP2-L4-1A	Aluminum lug	1	500-3 (240-35)	Cu/Al 75°C	42.0 (375)	
CCP2-L4B-3	Stainless steel lug kit with shroud	3	750-500 (400-240)	Cu 75°C	57.0 (500)	
CCP2-L4B-3A	Aluminum lug kit with shroud	3	750-500 (400-240)	Cu/Al 75°C	62.0 (550)	
CCP2-L6-3	2-port stainless steel lug kit with shroud	3	(2) 500-2 (240-35)	Cu 75°C	42.0 (375)	
CCP2-L6-3A	2-port aluminum lug kit with shroud	3	(2) 500-2 (240-25)	Cu/Al 75°C	42.0 (375)	
CCP2-L6-3CW	2-port stainless steel lug kit with shroud with control tab	3	(2) 500-2 (240-35)	Cu 75°C	42.0 (375)	22.0 (200)
CCP2-L6-3ACW	2-port aluminum lug kit with shroud with control tab	3	(2) 500-2 (240-25)	Cu/Al 75°C	42.0 (375)	
					10-14 = 3.9 (35)	
					8 = 4.5 (40)	
CCP2-MW6-6	6-port multi-wire terminal with shroud	3	1/0-14 (50-2.5)	Cu/Al 75°C	4-6 = 5.0 (45)	
					1/0-2 = 5.6 (50)	

**Carton quantity**

Catalog no.	Description	Qty.
CCP2-L2-1	Stainless steel lug	1
CCP2-L2-1A	Aluminum lug	1
CCP2-MW2-3	3-port multi-wire terminal with shroud	3
CCP2-MW2-6	6-port multi-wire terminal with shroud	3
CCP2-CWK2	1/4" quick connect control wire terminals	12
CCP2-L4-1	Stainless steel lug	1
CCP2-L4-1A	Aluminum lug	1
CCP2-L4B-3	Stainless steel lug kit with shroud	3
CCP2-L4B-3A	Aluminum lug kit with shroud	3
CCP2-L6-3	2-port stainless steel lug kit with shroud	3
CCP2-L6-3A	2-port aluminum lug kit with shroud	3
CCP2-MW6-6	6-port multi-wire terminal with shroud	3
CCP2-L6-3CW	2-port stainless steel lug kit with shroud with control tab	3
CCP2-L6-3ACW	2-port aluminum lug kit with shroud with control tab	3

**Accessories**

Catalog no.	Switch amps	Description
CCP2-TS2-3		3-pole terminal shroud
CCP2-PB2	200	Phase barriers (pack of 2)
CCP2-RM2		Front rotary operator* (3-pole switch only)
CCP2-TS6-3		3-pole terminal shroud
CCP2-PB6	400	Phase barriers (pack of 2)
CCP2-RM4		Front rotary operator* (3-pole switch only)
CCP2-SM	200/400	Side rotary operator* (1-, 2- or 3-pole switches)
CCP2-SP4	400	Installation spacers

\* Complete installation requires pistol handle and shaft, order separately.

- CCP2-FLC2-xxx 200/400 Flange cable operator (36, 36X, 60, 60X, 120 and 120X)
- CCP2-FLR2-xxx 200/400 Flange rod operator (21 and 21X)

200 amp switch dimensions – mm (in)

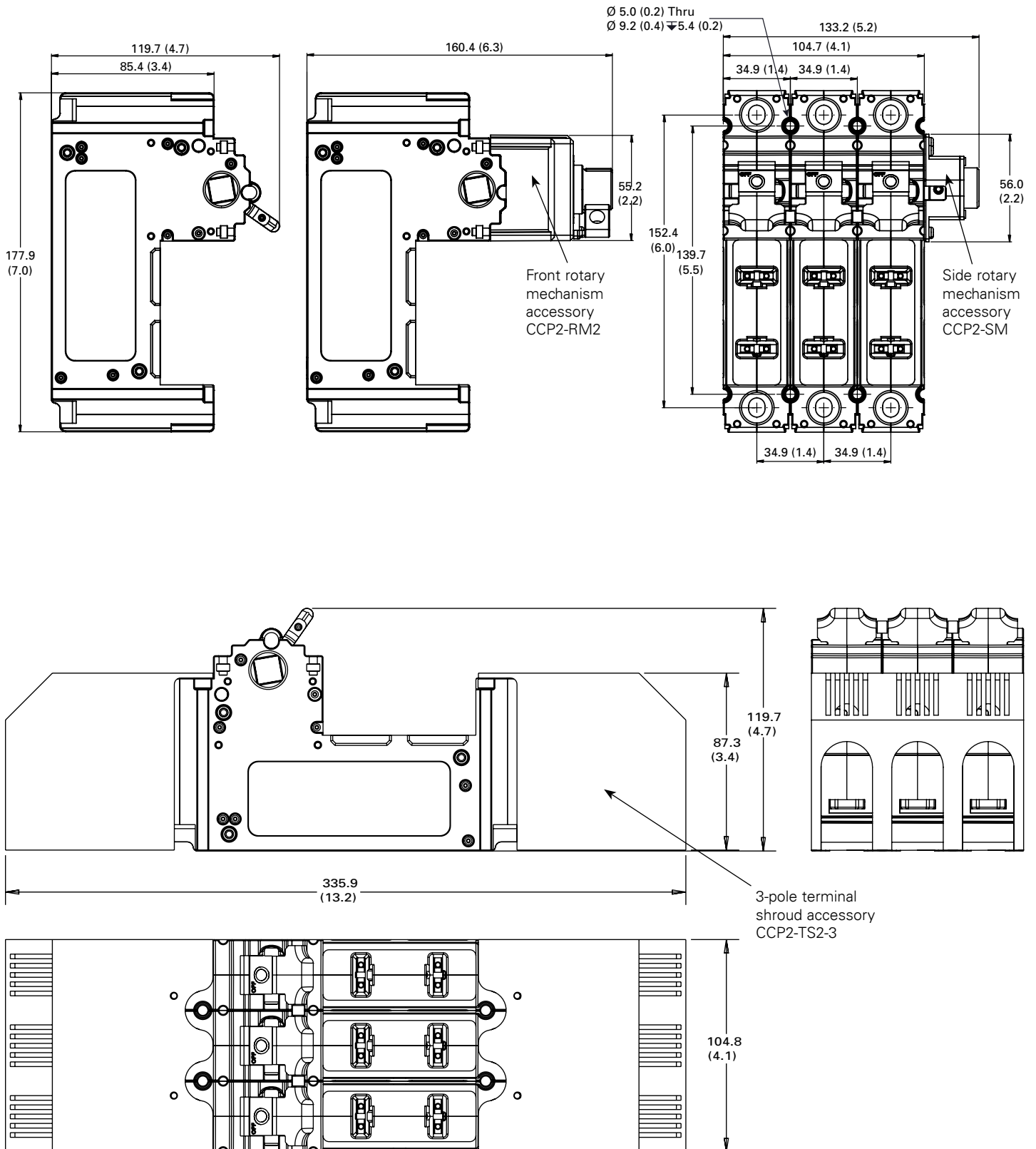

400 amp switch dimensions – mm (in)

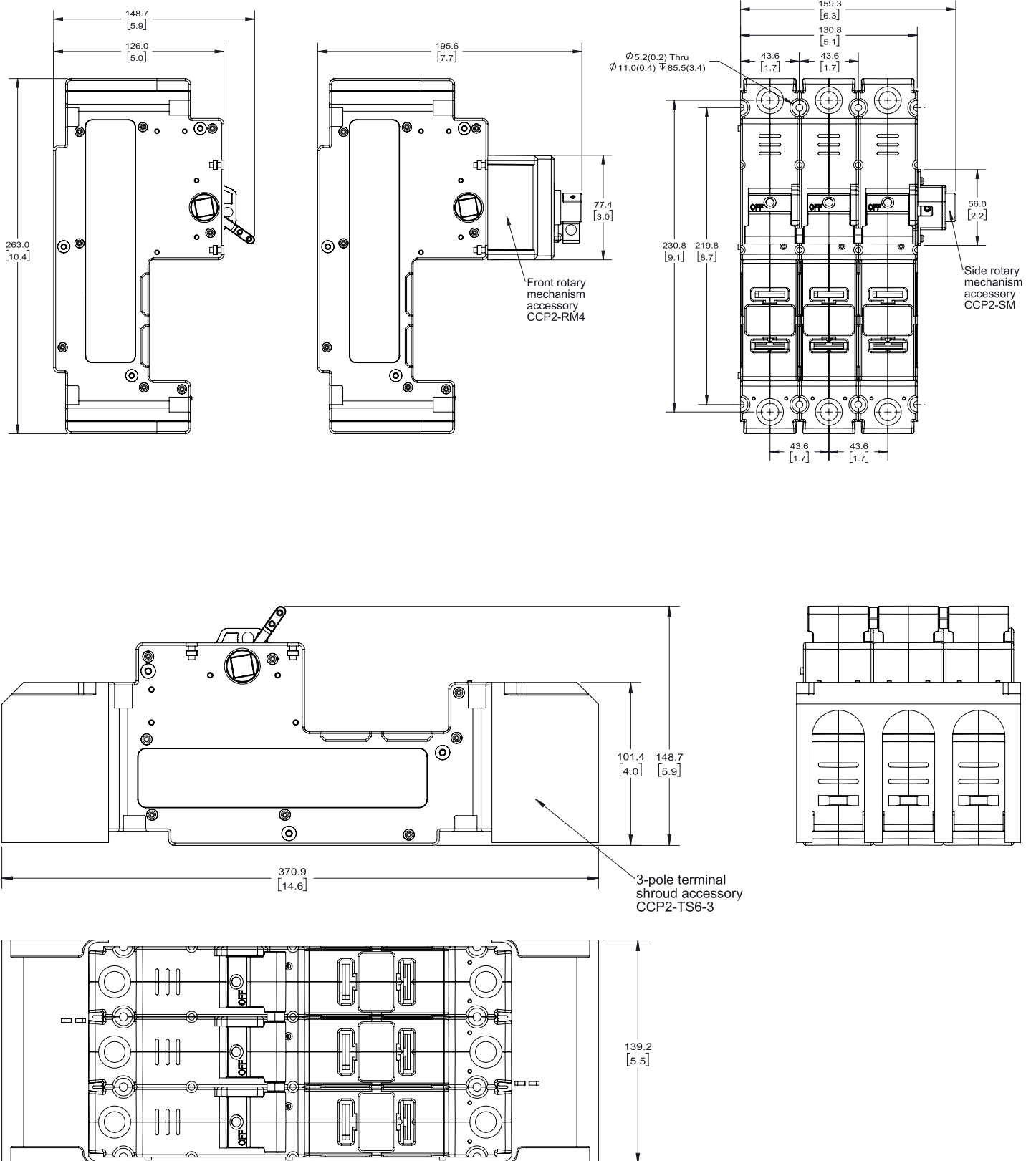

### 30, 60 and 100 A switch multi-wire lug kits

#### Catalog numbers

- CCP2-MW1-3 (30 and 60 A switches only)
- CCP2-MW1-6 (100 A switches only)
- CCP2-MW1-3C (100A switches only)

#### Description

The multi-wire lug kits permit expanding each box lug terminal on the switch into a three-port (30 and 60 A switches) or six-port (100 A switches) terminal for power distribution applications.

Each multi-wire lug kit comes with three lugs and three terminal shrouds. Shrouds provide finger-safe protection when properly installed.

Lugs may be mounted on either the loadside or lineside to meet various application needs.

Ports on any one lug accept any conductor combination listed, e.g., one of the ports may have dual 14 AWG wires and the other two ports single 10 AWG wires.

#### Ratings

- Volts 600 V
- Amps
  - 60 A max (CCP2-MW1-3)
  - 100 A max (CCP2-MW1-6)
- SCCR 200 kA

#### Agency information

- UL Recognized, Guide WHTY2, File E302370
- RoHS compliant

#### Storage and operating temperature

- -20°C to 75°C (-4°F to 167°F)

#### Multi-wire lug conductor information

- 75°C Cu/Al
- AWG size and quantity per port - see table below

Type	AWG range	Class	Quantity	Torque N•m (lb-in)
Cu/Al	4-6	Stranded, Class B/C	Single	3.95 (35)
	8			2.82 (25)
	10-14			2.26 (20)
Cu	10-14	Solid	Single	2.26 (20)
	8	UL ferrule, Class B to K	Single/twin†	2.82 (25)
	10-14			2.26 (20)

\* Dual wire to be same size and type.

† Two stranded conductors placed in one UL Listed twin ferrule.

ROW 2 Wire ranges 1-14 AWG				
Type	AWG range	Class	Single/dual	Torque N•m (lb-in)
Cu	1-3	Class G-K*	1	6.21 (55)
Cu/Al	1-3	Stranded, Class B/C	1	
Cu	4-6	Stranded, Class B/C	2	5.6 (50)
Cu	4-6	Class G-K*	1	
Cu/Al	4-6	Stranded, Class B/C	1	
Cu	8	Stranded, Class B/C	2	5.08 (45)
Cu	8	Class G-K*	1	
Al	8	Stranded, Class B/C	1	4.51 (40)
Cu	10-14	Stranded, Class B/C	2	
Cu	10-14	Stranded, Class B/C	1	3.95 (35)
Al	10-12	Stranded, Class B/C	1	

\* Class G-K is FLEX fine stranded Class G, H, I, DLO, K (MTW) and mm² Class 5.

#### Multi-wire lug conductor information (continued)

75°C Cu/Al solid or stranded wire as detailed below.

ROW 1 Wire ranges 4-14 AWG				
Type	AWG range	Class	Quantity	Torque N•m (lb-in)
Cu/Al	4-6	Stranded, Class B/C	Single	3.95 (35)
	8			2.82 (25)
	10-14			3.39 (30)
Cu	10-14	Solid	Single/dual*	2.26 (20)
	10-14		Single	2.26 (20)
	8	UL ferrule, Class B to K	Single	2.82 (25)
	10-14		Single/twin†	2.26 (20)

\* Dual wire to be same size and type.

† Two stranded conductors placed in one UL Listed twin ferrule.

#### CCP2 box lug torque for multi-wire lugs

- 30/60 A switch lug, 4.52 N•m (40 lb-in)
- 100 A switch lug, 5.09 N•m (45 lb-in)

#### Carton quantity

Catalog no.	Application	Qty.
CCP2-MW1-3	For 30/60 A switches only	3 lugs and 3 shrouds
CCP2-MW1-6	For 100 A switches only	
CCP2-MW1-3C	For 100 A switches only	

#### Installed on CCP2-3-xx

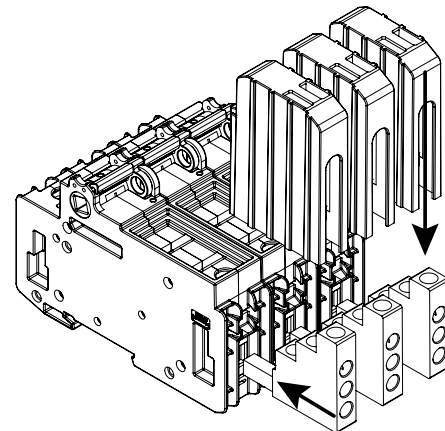

Multi-wire lugs mount in switch box lug terminals to provide three additional wire ports per pole. Lugs can be mounted on the switch lineside or loadside. Each multi-wire lug kit comes with three lugs and three shrouds.

**Wire insulation strip lengths**

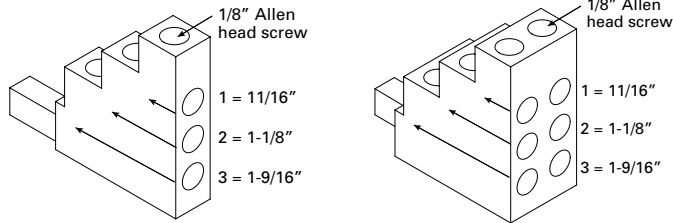

Strip back wire insulation to the lengths as indicated in the illustration above and the table below.

Lug port	Strip wire insulation back (inch)
1	11/16
2	1-1/8
3	1-9/16

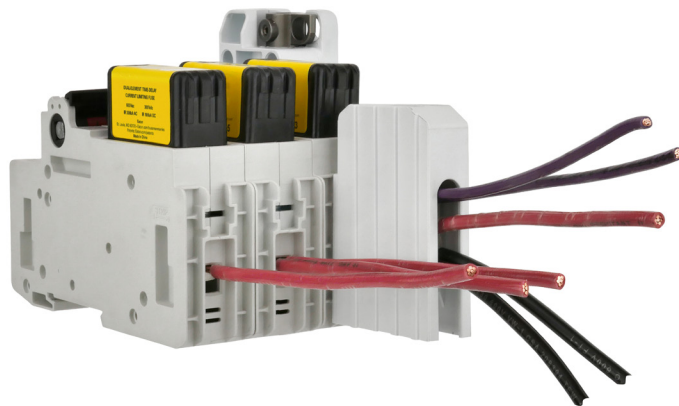

Wiring versatility is provided by single/dual rated box lug terminals on the switch, or by the three-port or six-port multi-wire lug kits that are also single/dual wire rated.

**Wire insulation strip lengths**

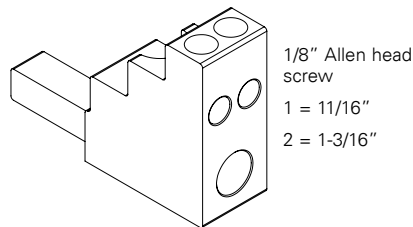

Strip back wire insulation to the lengths as indicated in the illustration above and the table below.

Lug port	Strip wire insulation back (inch)
1	11/16
2	1-3/16

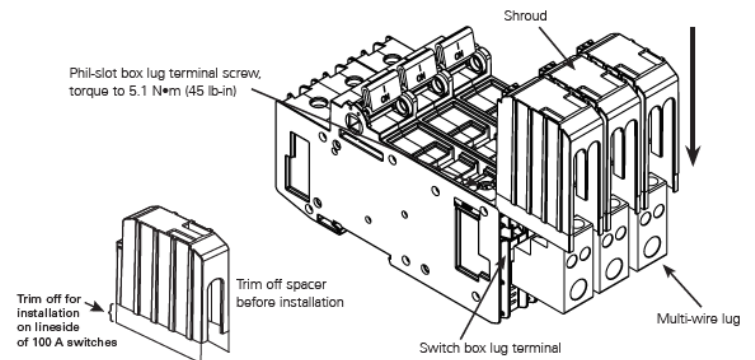

## 200 and 400 A switch multi-wire lug kits

### Catalog numbers

- CCP2-MW2-3 ( 3-port, 200 A switches only)
- CCP2-MW2-6 (6-port, 200 A switches only)
- CCP2-MW6-6 (6-port, 400 A switches only)

### Description

The multi-wire lug kits permit expanding the terminal on the switch into a three-port (200 A switches) or six-port (200 and 400 A switches) terminal for power distribution applications.

Each multi-wire lug kit comes with three lugs and a 3-pole terminal shroud. The shroud provides finger-safe protection when properly installed.

Lugs can only be mounted on loadside to meet application needs.

Ports on any one lug accept any conductor combination listed, e.g., one of the ports may have dual 14 AWG wires and the other two ports single 10 AWG wires.

### Ratings

- Volts 600 V
- Amps
  - 225 A max (CCP2-MW2-3 and CCP2-MW2-6)
  - 600 A max (CCP2-MW6-6)
- SCCR 200 kA

### Agency information

- UL Recognized, Guide WHTY2, File E302370
- RoHS compliant

### Storage and operating temperature

- -20°C to 75°C (-4°F to 167°F)

### Multi-wire lug conductor information

- 75°C Cu/AL
- AWG size and quantity per port - see table below

Catalog no.	Description	Lugs per cat. no.	Wire range AWG (mm <sup>2</sup> )	Wire type/ temp.	Conductor torque N·m (lb·in)	Lug mounting screw torque N·m (lb·in)
<b>200 A switches</b>						
CCP2-MW2-3	3-port multi-wire terminal with shroud	3	2-14 (35-2.5)	Cu/Al 75°C	7.9 (70)	10.8 (95)
CCP2-MW2-6	6-port multi-wire terminal with shroud	3	6-14 (16-2.5)	Cu/Al 75°C	2.8 (25)	10.8 (95)
<b>400 A Switches</b>						
CCP2-MW6-6	6-port multi-wire terminal with shroud	3	1/0-14 (50-2.5)	Cu/Al 75°C	10-14 = 3.9 (35) 8 = 4.5 (40) 4-6 = 5.0 (45) 1/0-2 = 5.6 (50)	22.0 (200)

### Carton quantity

Catalog no.	Application	Qty.
CCP2-MW2-3	For 200 A switches only	3 lugs and 1 3-pole shroud
CCP2-MW2-6		
CCP2-MW6-6	For 400 A switches only	

### Installed on CCP2-3-xx

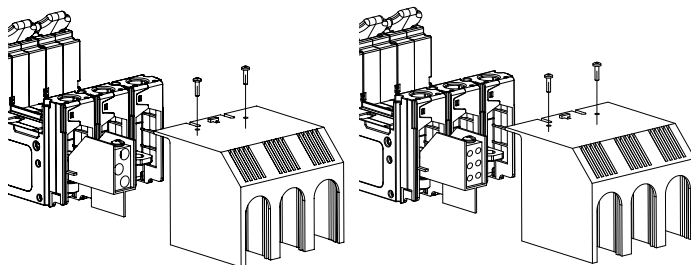

### 3- and 6-port multi-wire lugs mounted on 200 A switches

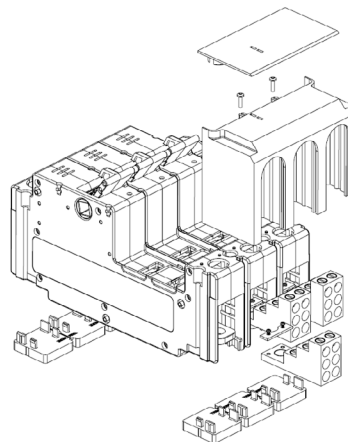

### 6-port multi-wire lugs mounted on 400 A switches

Multi-wire lugs mount on the switch terminals to provide three or six additional wire ports per pole. Lugs to be mounted only on the loadside. Each multi-wire lug kit comes with three lugs, a shroud and mounting hardware.

### Wire insulation strip lengths

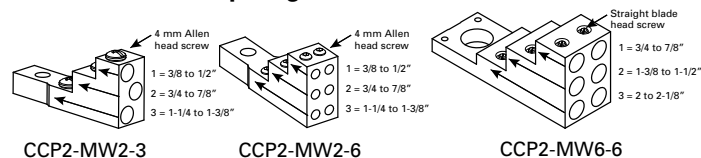

Lug kit	Wire insulation strip length (inch)		
	Lug port 1	Lug port 2	Lug port 3
CCP2-MW2-3	3/8 to 1/2	3/4 to 7/8	1-1/4 to 1-3/8
CCP2-MW2-6			
CCP2-MW6-6	3/4 to 7/8	1-3/8 to 1-1/2	2 to 2-1/8

Strip back wire insulation to the lengths indicated in the illustration above and the table below.

**Selector and pistol handles**

**Catalog symbol**

- CCP2-H4X-1 (selector handle for 30, 60 and 100 A switches)
- CCP2-H4X-2 (pistol handle for 30, 60 and 100 A switches)
- CCP2-H4X-3 (short pistol handle for 200 and 400 A switches)
- CCP2-H4X-4 (long pistol handle for 200 and 400 A switches)

**Description**

Selector and pistol handles are used with rotary operated switches. Pistol handles for 200 and 400 A switches come in short and long versions. All handles are available in black/grey and red/yellow colors, and clockwise/counterclockwise operating modes. Front and right side operated switches use clockwise handles while left side operated switches use counterclockwise handles.

Installation requires an 8 mm shaft for 30, 60 and 100 A switches and a 12 mm shaft for 200 and 400 A switches (ordered separately).

Each handle is rated Type 1, 4X and 12, and accepts up to three (3) 1/4" diameter shank locks for lockout/tagout in the OFF position. They can also be field configured for lock-on and are defeatable.

Only the clockwise operating handles in combination with front rotary operating switches provide a door interlock means to ensure the enclosure door remains shut during lockout/tagout or lock-on. Rotary handles mounted on the enclosure's left or right side do NOT provide a door interlock means.

See the catalog number table below for applicable rotary switch, handle and shaft combinations.

**Handles and shafts for 30, 60 and 100 A switches**

For catalog no.	Description/operation	Order handle cat. no.	Order either 8 mm shaft cat. no.
CCP2R-(pole)-30CF	Right front rotary, clockwise	CCP2-H4X-B1 (selector, black/grey)	CCP2-SH1-290 (11.5"/290 mm)
CCP2R-(pole)-60CF			
CCP2R-(pole)-100CF			
CCP2RL-(pole)-30CF	Left front rotary, clockwise	CCP2-H4X-R1 (selector, red/yellow)	CCP2-SH1-490 (19.3"/490 mm)
CCP2RL-(pole)-60CF			
CCP2RL-(pole)-100CF			
CCP2S-(pole)-30CF	Right side rotary, clockwise	CCP2-H4X-R2 (pistol, red/yellow)	CCP2-SH1-290 (11.5"/290 mm)
CCP2S-(pole)-60CF			
CCP2S-(pole)-100CF			
CCP2SL-(pole)-30CF	Left side rotary, counterclockwise	CCP2-H4X-B1L (selector, black/grey)	CCP2-SH1-290 (11.5"/290 mm)
CCP2SL-(pole)-60CF			
CCP2SL-(pole)-100CF			
		CCP2-H4X-R1L (selector, red/yellow)	
		CCP2-H4X-B2L (pistol, black/grey)	
		CCP2-H4X-R2L (pistol, red/yellow)	

**Handles and shafts for 200 and 400 A switches**

For catalog no.	Order front rotary mechanism cat. no.	Order right/left side rotary mechanism cat. no.	Order front/right side clockwise handle cat. no.	Order left side counterclockwise handles (use only with CCP2-SM) cat. no.	Order either 12 mm shaft cat. no.
CCP2-(poles)-200CF	CCP2-RM2*	CCP2-SM	CCP2-H4X-B3 (short - black/grey)	CCP2-H4X-B3L (short - black/grey)	CCP2-SH2-225 (8.9"/225 mm)
			CCP2-H4X-R3 (short - red/yellow)	CCP2-H4X-R3L (short - red/yellow)	
CCP2-(poles)-400CF	CCP2-RM4*		CCP2-H4X-B4 (long - black/grey)	CCP2-H4X-B4L (long - black/grey)	CCP2-SH2-425 (16.7"/425 mm)
			CCP2-H4X-R4 (long - red/yellow)	CCP2-H4X-R4L (long - red/yellow)	

\* For three-pole switches only.

**Selector handles**

**Pistol handles — short and long**



**Agency information**

- UL Listed, Guide DIHS/DIHS7, File E140305
- Type 1, 4X and 12
- RoHS compliant
- CE

**Storage and operating temperature**

- -20°C to 75°C (-4°F to 167°F)

**Carton quantity**

Catalog no.	Description	Qty.
CCP2-H4X-1	30/60/100 A selector handles	1
CCP2-H4X-2	30/60/100 A pistol handles	1
CCP2-H4X-3	200/400 A short pistol handles	1
CCP2-H4X-4	200/400 A long pistol handles	1

**Handle dimensions – mm (in)**

**Selector for 8 mm shafts**

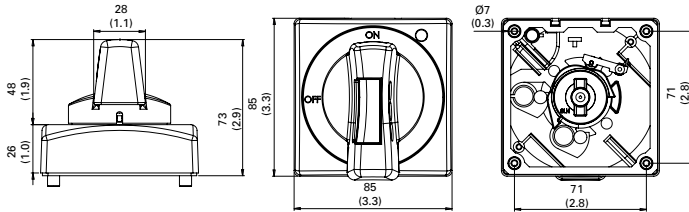

**Short pistol for 8 mm and 12 mm shafts**

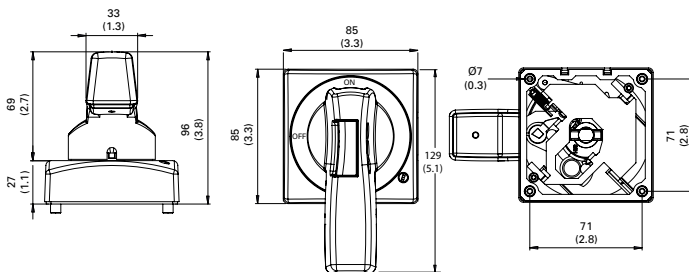

**Long pistol for 12 mm shafts**

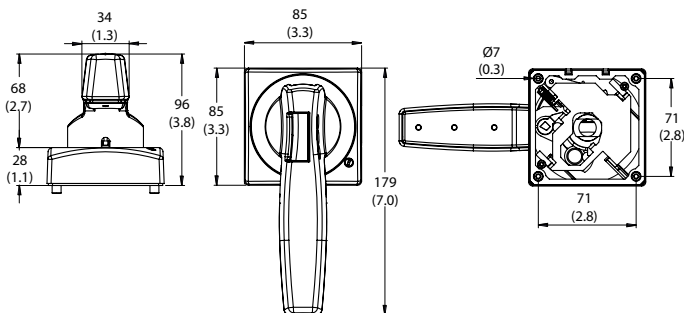

**NFPA 79 compliant handles**

**Catalog numbers**

- CCP2-NFPA-1 (8 mm shafts for 30-100 A switches)
- CCP2-NFPA-2 (12 mm shafts for 200 and 400 A switches)

**Description**

NFPA 79 handles mount on the shaft of front rotary operated switch installations and provide a lockout means independent of the door position.

**Carton quantity**

Catalog no.	Fits shaft size	Qty.
CCP2-NFPA-1	8 mm	1
CCP2-NFPA-2	12 mm	1



**Handle shafts**

**8 mm shafts**

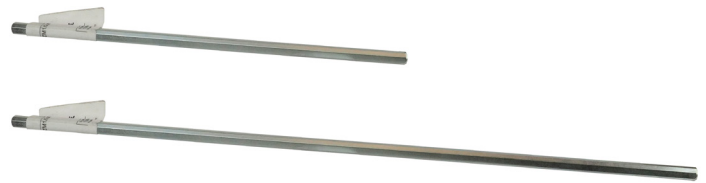

**12 mm shafts**



**Catalog numbers**

- CCP2-SH1-290 (8 mm, 290 mm long)
- CCP2-SH1-490 (8 mm, 490 mm long)
- CCP2-SH2-225 (12 mm, 225 mm long)
- CCP2-SH2-425 (12 mm, 425 mm long)

**Description**

Square shafts available in:

- 8 mm square by 290 and 490 mm lengths for 30, 60 and 100 A switches
- 12 mm square by 225 and 425 mm lengths for 200 and 400 A switches

All shafts are indexed to ensure handle/switch orientation for correct operation. Shafts are to be cut to length when installed.

**Carton quantity**

Catalog no.	Size	Length	Qty.
CCP2-SH1-290	8 mm	290 mm	1
CCP2-SH1-490		490 mm	1
CCP2-SH2-225	12 mm	225 mm	1
CCP2-SH2-425		425 mm	1



### Flange handle rod and cable operators

Catalog no.	Description	Rating
<b>30, 60 and 100 amp switches</b>		
CCP2-FLR1-21	Rod operator with painted handle	Type 1, 3R, 12
CCP2-FLR1-21X	Rod operator with chrome handle	Type 4X
CCP2-FLC1-36	36" Cable with painted handle	Type 1, 3R, 12
CCP2-FLC1-36X	36" Cable with chrome handle	Type 4X
CCP2-FLC1-60	60" Cable with painted handle	1, 3R, 12
CCP2-FLC1-60X	60" Cable with chrome handle	Type 4X
CCP2-FLC1-120	120" Cable with painted handle	Type 1, 3R, 12
CCP2-FLC1-120X	120" Cable with chrome handle	Type 4X

Catalog no.	Description	Rating
<b>200 and 400 amp switches</b>		
CCP2-FLR2-21	Rod operator with painted handle	Type 1, 3R, 12
CCP2-FLR2-21X	Rod operator with chrome handle	Type 4X
CCP2-FLC2-36	36" Cable with painted handle	Type 1, 3R, 12
CCP2-FLC2-36X	36" Cable with chrome handle	Type 4X
CCP2-FLC2-60	60" Cable with painted handle	1, 3R, 12
CCP2-FLC2-60X	60" Cable with chrome handle	Type 4X
CCP2-FLC2-120	120" Cable with painted handle	Type 1, 3R, 12
CCP2-FLC2-120X	120" Cable with chrome handle	Type 4X

#### Description

Flange rod and cable operators for use on 3-pole CCP2 switches. Handles are available in painted versions with Type 1, 3R and 12 ratings or chrome versions with a Type 4X rating. Cable operators are available with 36, 60 and 120 inch cable lengths.

#### Agency information

- Type 1, 3R, 4X and 12
- RoHS compliant

#### Storage and operating temperature

- -20°C to 75°C (-4°F to 167°F)

#### Packaging

- Each handle is packaged individually as a kit

#### Carton quantities

Catalog no.	Switch amps/description	Qty.
CCP2-FLR1-21_	30/60/100 A rod operator	1
CCP2-FLC1-36_	30/60/100 A 36" cable operator	1
CCP2-FLC1-60_	30/60/100 A 60" cable operator	1
CCP2-FLC1-120_	30/60/100 A 120" cable operator	1

Catalog no.	Switch amps/description	Qty.
CCP2-FLR2-21_	200/400 A rod operator	1
CCP2-FLC2-36_	200/400 A 36" cable operator	1
CCP2-FLC2-60_	200/400 A 60" cable operator	1
CCP2-FLC2-120_	200/400 A 120" cable operator	1



Flange rod operator kit for 100 A switches.

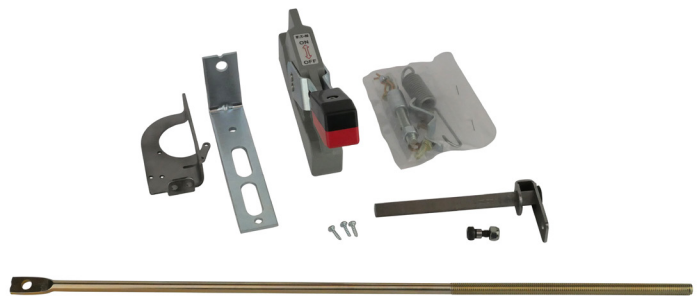

Flange rod operator kit for 200 and 400 A switches.

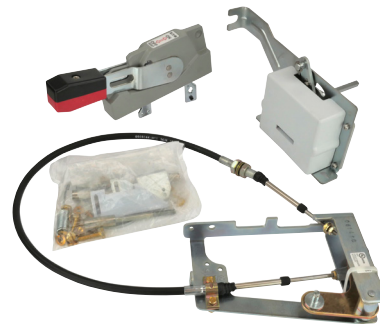

Flange cable operator kit for 100 A switches.

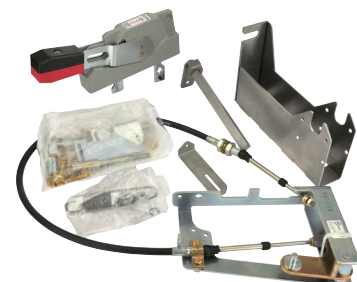

Flange cable operator kit for 200 and 400 A switches.

**Front rotary mechanisms for 200 and 400 A switches**



Catalog numbers

- CCP2-RM2 (3-pole 200 A switches)
- CCP2-RM4 (3-pole 400 A switches)

Description

Front rotary mechanisms for through-the-door operation and install on the front of 3-pole switches only. These units provide at-switch lockout/tagout capability for enhanced safety. Complete installation requires installing pistol handle (short or long) and 12 mm shaft.

Packaged individually.

**Side rotary mechanism for 200 and 400 A switches**

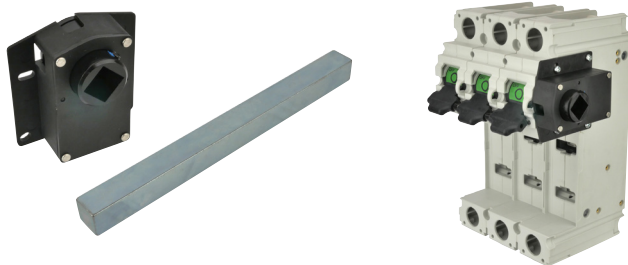

Catalog number

- CCP2-SM (1-, 2- or 3-pole 200 and 400 A switches)

Description

Side rotary mechanism for through-the-side operation and installs on the left or right side (right side installation recommended) of any 1-, 2- or 3-pole 200 and 400 A switch. The side rotary mechanism does not provide for door interlock nor local lockout/tagout capability. Complete installation requires installing pistol handle (short or long) and 12 mm shaft.

Packaged individually.

**Terminal shrouds**

Catalog numbers

- CCP2-TS2-3 (3-pole 200 A switches)
- CCP2-TS6-3 (3-pole 400 A switches)

Description

3-pole shroud kit with shields for isolating the lugs on 3-pole 200 and 400 A switches.

Packaged individually.

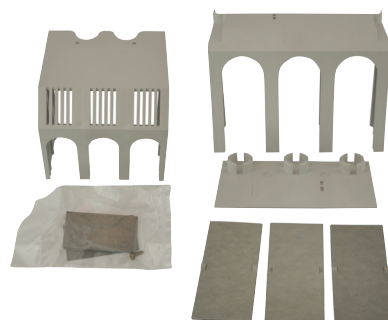

**Phase barriers**

Catalog numbers

- CCP2-PB2 (3-pole 200 A switches)
- CCP2-PB6 (3-pole 400 A switches)

Description

Phase barrier kit with two phase barriers for isolation between the lugs on 3-pole 200 and 400 A switches.

Packaged individually.

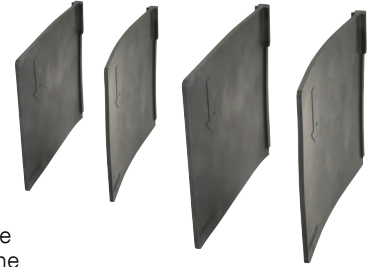

**Handle extension**



Catalog number

- CCP2-HEX (1-, 2- and 3-pole 200 and 400 A switches)

Description

A handle extension to provide additional leverage for operating the switch in installations that do not have rotary mechanisms or flange operators installed. Does not mount on switch, provision for tether provided.

Packaged individually.

**Spacer - 400 A Switch**

Catalog numbers

- CCP2-SP4 (Adjustable for 1 and 2 poles)

Description

Spacer kit designed to ease installation. Included with all 400 A CCP2 and CCD2 orders. Only needs to be ordered separately for replacement purposes.



## Auxiliary contacts for 30, 60 and 100 A switches

### Catalog numbers

- CCP2-AUX (30 and 60 A switches)
- CCP2-AUX-100 (100 A switches)

### Description

NO+NC contact output to indicate the switching mechanism status on the CCP2. A single unit can be mounted on any 1-, 2- or 3-pole CUBEFuse CCP2 switch and the left front/left side rotary operated switches.



### Ratings

- 240 Vac max
- 5 A max
- NC/NO contacts are closed/open when the CCP2 switch is in the "ON" position (closed)

Catalog no.	Switch	Description	Max per CCP2*	Ratings
CCP2-AUX	30/60 A only	Auxiliary contacts N/NC for switch status	1 per CCP2 (1-, 2- or 3-pole)	5 A / 240 Vac
CCP2-AUX-100	100 A only			

\* The CCP2-AUX CANNOT be mounted on the right front and right side rotary operated versions, nor installed with the flange handle rod or cable operator. De-energize all circuits and follow all prescribed safety procedures before installing or removing the auxiliary contact device.

### Agency information

- UL 98 Recognized, Guide WHTY2, File E155130
- cURus to Canadian Standard 22.2 No. 4-04
- Finger-safe in installed state
- RoHS compliant
- CE

### Wiring

- 16-20 AWG (1.5 to 0.5 mm<sup>2</sup>) single and dual stranded wire
- 20 AWG (1.5 mm<sup>2</sup>) single and dual solid wire
- Torque 0.56 N•m (5 lb-in)
- Use only 75°C Cu wire

### Packaging

- CCP2-AUX and CCP2-AUX-100 are packaged individually

### Installation technique

- Mounts on the CCP2's right side ONLY and mechanically interlocks with the CCP2 switch handle with provided hardware. The CCP2-AUX and CCP2-AUX-100 CANNOT be mounted on the right front and right side rotary operated versions, or installed with the flange handle rod or cable operator.

### Storage and operating temperature

- -20°C to 75°C (-4°F to 167°F)

### Carton quantity and shipping weight

Catalog no.	Application	Qty.	Weight lb (kg)
CCP2-AUX	For 30 and 60 A switches only	1	0.14 (0.063)
CCP2-AUX-100	For 100 A switches only		

## Installed on a CCP2-3-xx

**Note:** CCP2-AUX and CCP2-AUX-100 CANNOT be mounted on the right front and right side rotary operated versions, nor if a flange handle rod or cable operator is installed.



## Dimensions — in

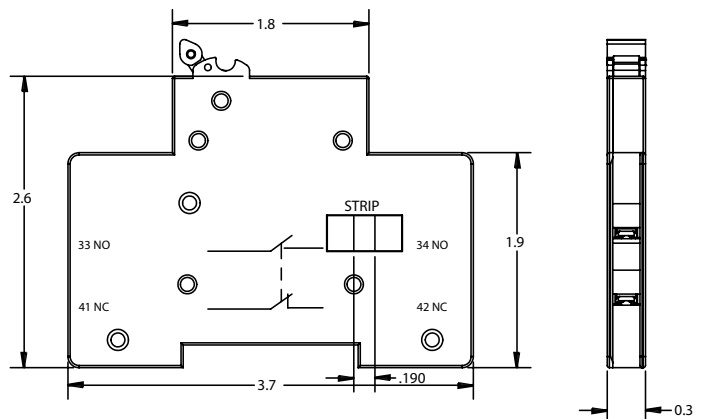

CCP2-AUX

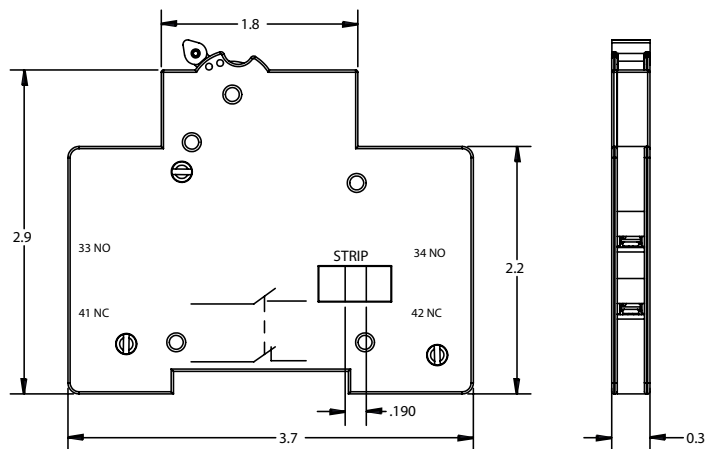

CCP2-AUX-100

**Auxiliary contacts for 200 and 400 A switches**

**Catalog number**

- CCP2-AUX-S (200 and 400 A switches)

**Description**

NO+NC contact output to indicate the switching mechanism status on the CCP2. A single unit can be mounted on either side of any 1-, 2- or 3-pole switch (cannot be mounted on the same side as the CCP2-SM side rotary mechanism or the right side if a flange handle rod or cable operator is installed).



**Ratings**

- 240 Vac max
- 5 A max
- NC/NO contacts are closed/open when the CCP2 switch is in the "ON" position (closed)

Catalog no.	Switch	Description	Max per CCP2*	Ratings
CCP2-AUX-S	200 and 400 A	Auxiliary contacts NO+NC for switch status	1 per CCP2 (1-, 2- or 3-pole)	5 A / 240 Vac

\* The CCP2-AUX-S CANNOT be mounted on the same side where the side rotary mechanism (CCP2-SM) is installed.  
De-energize all circuits and follow all prescribed safety procedures before installing or removing the auxiliary contact device.

**Agency information**

- UL 98 Recognized, Guide WHTY2, File E155130
- cURus to Canadian Standard 22.2 No. 4-04
- Finger-safe in installed state
- RoHS compliant

**Wiring**

- 16-20 AWG (1.5 to 0.5 mm<sup>2</sup>) single and dual stranded wire
- 20 AWG (1.5 mm<sup>2</sup>) single and dual solid wire
- Torque 0.56 N•m (5 lb-in)
- Use only 75°C Cu wire

**Installation technique**

- Mounts on either side of the 200 and 400 A switches and mechanically interlocks with the switch's handle with provided hardware. The CCP2-AUX-S CANNOT be mounted on the same side with an installed CCP2-SM side rotary mechanism, or the flange cable/rod operating mechanisms.

**Storage and operating temperature**

- -20°C to 75°C (-4°F to 167°F)

**Packaging**

- Packaged individually.

**Installed on a CCP2-3-xx**







**Note:** CCP2-AUX-S CANNOT be mounted on the same side as the side rotary mechanism CCP2-SM or the right side if a flange handle rod or cable operator is installed.





**Ordering a complete switch installation**

**30 and 60 A CCP2 clockwise rotary switches**

For a complete assembly, select from the following required and optional components, and accessories.







<b>Required</b>	<b>Catalog no.</b>			
	<b>Switches</b>	<b>Amps</b>	<b>Poles</b>	
	<b>Right front rotary</b>			
		CCP2R-2-30CF	30	2
		CCP2R-3-30CF		3
		CCP2R-2-60CF	60	2
		CCP2R-3-60CF		3
	<b>Left front rotary</b>			
		CCP2RL-2-30CF	30	2
		CCP2RL-3-30CF		3
		CCP2RL-2-60CF	60	2
		CCP2RL-3-60CF		3
	<b>Right side rotary</b>			
		CCP2S-2-30CF	30	2
		CCP2S-3-30CF		3
		CCP2S-2-60CF	60	2
		CCP2S-3-60CF		3
	<b>And</b>			
	<b>Rotary handles</b>	<b>Description</b>	<b>Rating</b>	
	CCP2-H4X-B1	Selector handle — black/grey	Type 1, 4X, 12	
	CCP2-H4X-R1	Selector handle — red/yellow		
	CCP2-H4X-B2	Pistol handle — black/grey		
	CCP2-H4X-R2	Pistol handle — red/yellow		
<b>And</b>				
	<b>Shafts (8 mm)</b>	<b>Length</b>		
	CCP2-SH1-290	290 mm		
	CCP2-SH1-490	490 mm		
	<b>NFPA 79 compliant handle</b>	<b>Color</b>		
	CCP2-NFPA-1	Red		
<b>And</b>				
<b>Optional</b>	<b>Multi-wire lug kits</b>	<b>Description</b>		
		CCP2-MW1-3	3-port multi-wire, 75°C Cu/Al, 6-14, includes terminal shrouds, pack of 3	

And			
<b>Accessories</b>		<b>Terminal shrouds</b>	<b>Description</b>
		CCP2-TS1-3	Pack of 3
		<b>Auxiliary contacts</b>	<b>Description — use with CCP2RL-(poles)-30/60CF switches</b>
		CCP2-AUX	NO/NC, 5 A / 240 V

**Ordering a complete switch installation**

**30 and 60 A CCP2 switches**

For a complete assembly, select from the following required and optional components, and accessories.

Required	Catalog no.			
	Switches	Amps	Poles	
	Switch (used alone or with flange cable or flange rod handles)			
	CCP2-1-30CF	30	1	
	CCP2-2-30CF		2	
	CCP2-3-30CF		3	
	CCP2-1-60CF	60	1	
	CCP2-2-60CF		2	
	CCP2-3-60CF		3	
<b>And</b>				
Optional		<b>Flange handle rod operator</b>	<b>Description — 3-pole switches only</b>	<b>Rating</b>
		CCP2-FLR1-21	Red/black painted handle	1, 3R and 12
		CCP2-FLR1-21X	Chrome handle	4X
	<b>Or</b>			
		<b>Flange handle cable operator</b>	<b>Description - 3-pole switches only, cannot be used with side or front rotary mechanisms</b>	<b>Rating</b>
		CCP2-FLC1-36	36" cable, red/black painted handle	Type 1, 3R, 12
		CCP2-FLC1-36X	36" cable, chrome handle	Type 4X
		CCP2-FLC1-60	60" cable, red/black painted handle	Type 1, 3R, 12
		CCP2-FLC1-60X	60" cable, chrome handle	Type 4X
		CCP2-FLC1-120	120" cable, red/black painted handle	Type 1, 3R, 12
	CCP2-FLC1-120X	120" cable, chrome handle	Type 4X	
	<b>And</b>			
		<b>Multi-wire lug kits</b>	<b>Description</b>	
		CCP2-MW1-3	3-port multi-wire, 75°C Cu/Al, 6-14, includes terminal shrouds, pack of 3	
	<b>And</b>			
Accessories		<b>Terminal shrouds</b>	<b>Description</b>	
		CCP2-TS1-3	Pack of 3	
	<b>Auxiliary contacts</b>	<b>Description — mounts on right side, cannot be used with flange handle rod or cable operator</b>		
	CCP2-AUX	NO/NC, 5 A / 240 V		

**Ordering a complete switch installation**  
**30 and 60 A CCP2 counterclockwise switches**

For a complete assembly, select from the following required and optional components, and accessories.

	Catalog no.				
	Switches	Amps	Poles		
	Left side rotary				
<b>Required</b>		CCP2SL-2-30CF	30	2	
		CCP2SL-3-30CF		3	
		CCP2SL-2-60CF	60	2	
		CCP2SL-3-60CF		3	
	<b>And</b>				
		<b>Rotary handles</b>	<b>Description</b>	<b>Rating</b>	
		CCP2-H4X-B1L	Selector handle — black/grey	Type 1, 4X, 12	
		CCP2-H4X-R1L	Selector handle — red/yellow		
		CCP2-H4X-B2L	Pistol handle — black/grey		
		CCP2-H4X-R2L	Pistol handle — red/yellow		
	<b>And</b>				
		<b>Shafts (8 mm)</b>	<b>Length</b>		
		CCP2-SH1-290	290 mm		
		CCP2-SH1-490	490 mm		
		<b>NFPA 79 compliant handle</b>	<b>Color</b>		
		CCP2-NFPA-1	Red		
<b>And</b>					
<b>Optional</b>		<b>Multi-wire lug kits</b>	<b>Description</b>		
		CCP2-MW1-3	3-port multi-wire, 75°C Cu/Al, 6-14, includes terminal shrouds, pack of 3		
<b>And</b>					
<b>Accessories</b>		<b>Terminal shrouds</b>	<b>Description</b>		
		CCP2-TS1-3	Pack of 3		
		<b>Auxiliary contacts</b>	<b>Description — mounts on right side</b>		
	CCP2-AUX	NO/NC, 5 A / 240 V			





**Ordering a complete switch installation**

**100 A CCP2 clockwise rotary switches**

For a complete assembly, select from the following required and optional components, and accessories.







<b>Required</b>	<b>Catalog no.</b>			
	<b>Switches</b>	<b>Amps</b>	<b>Poles</b>	
	<b>Right front rotary</b>			
		CCP2R-2-100CF	100	2
		CCP2R-3-100CF		3
	<b>Left front rotary</b>			
		CCP2RL-2-100CF	100	2
		CCP2RL-3-100CF		3
	<b>Right side rotary</b>			
		CCP2S-2-100CF	100	2
		CCP2S-3-100CF		3
	<b>And</b>			
		<b>Rotary handles</b>	<b>Description</b>	<b>Rating</b>
		CCP2-H4X-B1	Selector handle — black/grey	Type 1, 4X, 12
		CCP2-H4X-R1	Selector handle — red/yellow	
CCP2-H4X-B2		Pistol handle — black/grey		
CCP2-H4X-R2		Pistol handle — red/yellow		
<b>And</b>				
	<b>Shafts (8 mm)</b>	<b>Length</b>		
	CCP2-SH1-290	290 mm		
	CCP2-SH1-490	490 mm		
	<b>NFPA 79 compliant handle</b>	<b>Color</b>		
	CCP2-NFPA-1	Red		
<b>And</b>				
<b>Optional</b>		<b>Multi-wire lug kits</b>	<b>Description</b>	
		CCP2-MW1-6	6-port multi-wire, 75°C Cu/Al, 6-14, includes terminal shrouds, pack of 3	
		CCP2-MW1-3C	3-port, 75°C Cu/Al, 1-14, includes terminal shrouds, pack of 3, useful for control wire setups on the line side of the switch	

And			
<b>Accessories</b>		<b>Terminal shrouds</b>	<b>Description</b>
		CCP2-TS1-6	Pack of 3
		<b>Auxiliary contacts</b>	<b>Description — cannot be used on right front or right side operated switches</b>
		CCP2-AUX-100	NO/NC, 5 A / 240 V

**Ordering a complete switch installation**







**100 A CCP2 switches**

For a complete assembly, select from the following required and optional components, and accessories.

Required	Catalog no.			
	Switches	Amps	Poles	
	Switch (used alone or with flange cable or flange rod handles)			
		CCP2-1-100CF	100	1
	CCP2-2-100CF	2		
	CCP2-3-100CF	3		
<b>And</b>				
Optional	Flange handle rod operator		Description — 3-pole switches only	Rating
		CCP2-FLR1-21	Red/black painted handle	1, 3R and 12
		CCP2-FLR1-21X	Chrome handle	4X
		<b>Or</b>		
	Flange handle cable operator		Description - 3-pole switches only, cannot be used with side or front rotary mechanisms	Rating
		CCP2-FLC1-36	36" cable, red/black painted handle	Type 1, 3R, 12
		CCP2-FLC1-36X	36" cable, chrome handle	Type 4X
		CCP2-FLC1-60	60" cable, red/black painted handle	Type 1, 3R, 12
		CCP2-FLC1-60X	60" cable, chrome handle	Type 4X
		CCP2-FLC1-120	120" cable, red/black painted handle	Type 1, 3R, 12
		CCP2-FLC1-120X	120" cable, chrome handle	Type 4X
	Multi-wire lug kits		Description	
		CCP2-MW1-6	6-port multi-wire, 75°C Cu/Al, 6-14, includes terminal shrouds, pack of 3	
CCP2-MW1-3C		3-port, 75°C Cu/Al, 1-14, includes terminal shrouds, pack of 3, useful for control wire setups on the line side of the switch		
<b>And</b>				
Accessories	Terminal shrouds		Description	
		CCP2-TS1-6	Pack of 3	
		Auxiliary contacts		Description — mounts on right side, cannot be used with flange handle rod or cable operator
		CCP2-AUX-100	NO/NC, 5 A / 240 V	
		NFPA 79 compliant flange handle		Color
	CCP2-NFPA-1	Red		

**Ordering a complete switch installation**  
**100 A CCP2 counterclockwise switches**







For a complete assembly, select from the following required and optional components, and accessories.

		Catalog no.			
		Switches	Amps	Poles	
		Left side rotary			
<b>Required</b>		CCP2SL-2-100CF	100	2	
		CCP2SL-3-100CF		3	
	<b>And</b>				
		<b>Rotary handles</b>	<b>Description</b>	<b>Rating</b>	
		CCP2-H4X-B1L	Selector handle — black/grey	Type 1, 4X, 12	
		CCP2-H4X-R1L	Selector handle — red/yellow		
		CCP2-H4X-B2L	Pistol handle — black/grey		
		CCP2-H4X-R2L	Pistol handle — red/yellow		
	<b>And</b>				
		<b>Shafts (8 mm)</b>	<b>Length</b>		
		CCP2-SH1-290	290 mm		
		CCP2-SH1-490	490 mm		
		<b>NFPA 79 compliant flange handle</b>	<b>Color</b>		
		CCP2-NFPA-1	Red		
	<b>And</b>				
<b>Optional</b>		<b>Multi-wire lug kits</b>	<b>Description</b>		
		CCP2-MW1-6	6-port multi-wire, 75°C Cu/Al, 6-14, includes terminal shrouds, pack of 3		
	CCP2-MW1-3C	3-port, 75°C Cu/Al, 1-14, includes terminal shrouds, pack of 3, useful for control wire setups on the line side of the switch			
<b>And</b>					
<b>Accessories</b>		<b>Terminal shrouds</b>	<b>Description</b>		
		CCP2-TS1-6	Pack of 3		
		<b>Auxiliary contacts</b>	<b>Description — mounts on right side</b>		
CCP2-AUX-100		NO/NC, 5 A / 240 V			

**Ordering a complete switch installation**

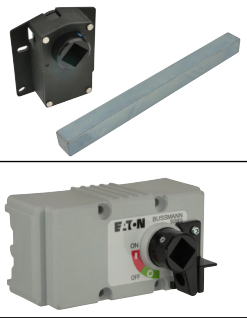
**200 A CCP2 switches**

For a complete installation, select from the following required and optional components, and accessories.

		Catalog no.				
		Switches	Amps	Poles		
<b>Required</b>		CCP2-1-200CF	200	1		
		CCP2-2-200CF		2		
		CCP2-3-200CF		3		
		<b>And</b>				
		<b>Lug kits</b>	<b>Description</b>			
		CCP2-L2-1	Stainless steel lug, 75° Cu only, 350 kcmil-4, 1 per pack			
CCP2-L2-1A		Aluminum lug, 75°C Cu/Al, 350 kcmil-4, 1 per pack				
CCP2-MW2-3		3-port multi-wire lug, 75°C Cu/Al, 2-14, 3 per pack, includes terminal shroud				
CCP2-MW2-6	6-port multi-wire lug, 75°C Cu/Al, 6-14, 3 per pack, includes terminal shroud					
<b>And</b>						
<b>Optional</b>		<b>Rotary mechanisms</b>	<b>Description</b>			
		CCP2-SM	Side rotary mechanism - mounts on left or right side of 1-, 2- and 3-pole switches			
		CCP2-RM2	Front rotary mechanism - mounts only on 3-pole switches, requires clockwise rotating handle			
	<b>And</b>					
		<b>Rotary handles</b>	<b>Description</b>	<b>Rotation - must match switch rotation</b>	Type 1, 4X, 12	
		CCP2-H4X-B3	Short pistol handle — black/grey	Clockwise		
		CCP2-H4X-R3	Short pistol handle — red/yellow	For use with front rotary mechanism or side rotary mechanism CCP2-SM on the switch's right side		
		CCP2-H4X-B4	Long pistol handle — black/grey			
		CCP2-H4X-R4	Long pistol handle — red/yellow	Counterclockwise		
		CCP2-H4X-B3L	Short pistol handle — black/grey			
		CCP2-H4X-R3L	Short pistol handle — red/yellow	Use <b>only</b> if installing side rotary mechanism CCP2-SM on the switch's left side		
		CCP2-H4X-B4L	Long pistol handle — black/grey			
	CCP2-H4X-R4L	Long pistol handle — red/yellow				
	<b>And</b>					
		<b>Shafts (12 mm)</b>	<b>Length</b>			
CCP2-SH2-225		225 mm				
CCP2-SH2-425		425 mm				
	<b>NFPA 79 compliant handle</b>	<b>Color</b>				
	CCP2-NFPA-2	Red				



<b>Optional</b>		<b>Or</b>		
		<b>Flange handle rod operator</b>	<b>Description — 3-pole switches only, cannot be used with side or front rotary mechanisms</b>	
		<b>Rating</b>		
		CCP2-FLR2-21	Red/black, painted handle	Type 1, 3R and 12
	CCP2-FLR2-21X	Chrome handle	Type 4X	
		<b>Or</b>		
		<b>Flange handle cable operator</b>	<b>Description - 3-pole switches only, cannot be used with side or front rotary mechanisms</b>	<b>Rating</b>
		CCP2-FLC2-36	36" cable, red/black painted handle	Type 1, 3R and 12
		CCP2-FLC2-36X	36" cable, chrome handle	Type 4X
		CCP2-FLC2-60	60" cable, red/black painted handle	Type 1, 3R and 12
CCP2-FLC2-60X		60" cable, chrome handle	Type 4X	
CCP2-FLC2-120		120" cable, red/black painted handle	Type 1, 3R and 12	
CCP2-FLC2-120X		120" cable, chrome handle	Type 4X	
<b>And</b>				
	<b>Terminal shrouds</b>	<b>Description</b>		
	CCP2-TS2-3	3-pole terminal shroud with phase shields, 1 per pack		
	<b>Phase barriers</b>	<b>Description</b>		
CCP2-PB2	Phase barriers, 2 per pack			
<b>And</b>				
<b>Accessories</b>		<b>Control wire terminals</b>	<b>Description</b>	
		CCP2-CWK2	1/4" quick-connect control wire terminals - mounts on installed lug (cannot be used with lug CCP2-L2-1), 12 per pack	
		<b>Auxiliary contacts</b>	<b>Description</b>	
		CCP2-AUX-S	NO/NC, 5 A, 240 V - Can be mounted on right or left side	
	<b>Handle extension</b>	<b>Description</b>		
	CCP2-HEX	Handle extension to facilitate operating 1-, 2 and 3-pole switches. Cannot be used when side or front rotary mechanisms or flange handle rod or cable operators are installed.		

**Ordering a complete switch installation**

**400 A CCP2 switches**

For a complete installation, select from the following required and optional components, and accessories.

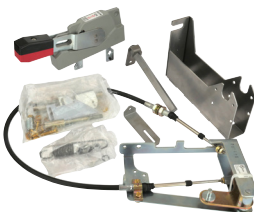
		Catalog no.				
		Switches	Amps	Poles		
<b>Required</b>		CCP2-1-400CF	400	1		
		CCP2-2-400CF		2		
		CCP2-3-400CF		3		
	<b>And</b>					
		<b>Lug kits</b>	<b>Description</b>			
		CCP2-L4-1	Stainless steel lug, 75° Cu only, 500 kcmil-3, 1 per pack			
		CCP2-L4-1A	Aluminum lug, 75° Cu only, 500 kcmil-3, 1 per pack			
		CCP2-L4B-3	Stainless steel lug, 75° Cu only, 750-500 kcmil, 3 per pack, includes terminal shroud			
		CCP2-L4B-3A	Aluminum lug, 75° Cu/Al, 750-500 kcmil, 3 per pack, includes terminal shroud			
		CCP2-MW6-6	6-port multi-wire lug, 75° Cu/Al, 1/0-14, 3 per pack, includes terminal shroud			
CCP2-L6-3		2-port stainless steel lug, 75° Cu only, 500 kcmil-2, 3 per pack, includes terminal shroud				
CCP2-L6-3A		2-port aluminum lug kit, 75° Cu/Al, 500 kcmil-2, 3 per pack, includes terminal shroud				
CCP2-L6-3CW		2-port stainless steel lug kit with shroud with control tab, 75° Cu only, 500 kcmil-2, 3 per pack				
CCP2-L6-3ACW	2-port aluminum lug kit with shroud with control tab, 75° Cu/Al, 500 kcmil-2, 3 per pack					
<b>And</b>						
<b>Optional</b>		<b>Rotary mechanisms</b>	<b>Description</b>			
		CCP2-SM	Side rotary mechanism - mounts on left or right side of 1-, 2- and 3-pole switches			
		CCP2-RM4	Front rotary mechanism - mounts only on 3-pole switches, requires clockwise rotating handle			
	<b>And</b>					
		<b>Rotary handles</b>	<b>Description</b>	<b>Rotation - must match switch rotation</b>	Type 1, 4X, 12	
		CCP2-H4X-B3	Short pistol handle — black/grey	Clockwise		
		CCP2-H4X-R3	Short pistol handle — red/yellow	For use with front rotary mechanism or side rotary mechanism CCP2-SM on the switch's right side		
		CCP2-H4X-B4	Long pistol handle — black/grey			
		CCP2-H4X-R4	Long pistol handle — red/yellow	Counterclockwise		
		CCP2-H4X-B3L	Short pistol handle — black/grey			
		CCP2-H4X-R3L	Short pistol handle — red/yellow	Use <b>only</b> if installing side rotary mechanism CCP2-SM on the switch's left side		
		CCP2-H4X-B4L	Long pistol handle — black/grey			
	CCP2-H4X-R4L	Long pistol handle — red/yellow				
	<b>And</b>					
		<b>Shafts (12 mm)</b>	<b>Length</b>			
CCP2-SH2-225		225 mm				
CCP2-SH2-425		425 mm				
	<b>NFPA 79 compliant handle</b>	<b>Color</b>				
	CCP2-NFPA-2	Red				

<b>Optional</b>		<b>Or</b>			
		<b>Flange handle rod operator</b>	<b>Description - 3-pole switches only, cannot be used with side or front rotary mechanisms</b>		
		<b>Rating</b>			
		CCP2-FLR2-21	Red/black, painted handle	Type 1, 3R, 12	
		CCP2-FLR2-21X	Chrome handle	Type 4X	
		<b>Or</b>			
		<b>Flange handle cable operator</b>	<b>Description - 3-pole switches only, cannot be used with side or front rotary mechanisms</b>	<b>Rating</b>	
			CCP2-FLC2-36	36" cable, red/black painted handle	Type 1, 3R, 12
			CCP2-FLC2-36x	36" cable, chrome handle	Type 4X
			CCP2-FLC2-60	60" cable, red/black painted handle	Type 1, 3R, 12
		CCP2-FLC2-60x	60" cable, chrome handle	Type 4X	
		CCP2-FLC2-120	120" cable, red/black painted handle	Type 1, 3R, 12	
	CCP2-FLC2-120x	120" cable, chrome handle	Type 4X		
<b>And</b>					
	<b>Terminal shrouds</b>	<b>Description</b>			
		CCP2-TS6-3	3-pole terminal shroud with phase shields, 1 per pack		
	<b>Phase barriers</b>	<b>Description</b>			
		CCP2-PB6	Phase barriers, 2 per pack		
<b>Accessories</b>	<b>And</b>				
	<b>Auxiliary contacts</b>	<b>Description</b>			
		CCP2-AUX-S	NO/NC, 5 A, 240 V - Can be mounted on right or left side		
	<b>Handle extension</b>	<b>Description</b>			
		CCP2-HEX	Handle extension to facilitate operating 1-, 2 and 3-pole switches. Cannot be used when side or front rotary mechanisms, or flange handle rod and cable mechanisms are installed.		
	<b>Spacer</b>	<b>Description</b>			
		CCP2-SP4	Optional replacement spacers for installation purposes		



**Motor sizing table (from NEC Tables 430.248 and 430.250)**

**Bussmann series TCF Low-Peak time-delay Class CF fuses**

Voltage	Motor size (Hp)	Motor FLA (amps)	Min (amps)	NEC code max (amps)	Heavy start* (amps)
<b>115 Vac, 1-phase</b>	1/6	4.4	10	10	10
	1/4	5.8	10	15	15
	1/3	7.2	15	15	15
	1/2	9.8	15	20	20
	3/4	13.8	25	25	30
	1	16	25	30	35
	1-1/2	20	30	35	45
	2	24	40	45	50
	3	34	50	60	70
	5**	56	90	100	125
	7-1/2	80	125	150	175
	10	100	150	175	225
<b>230 Vac, 1-phase</b>	1/6	2.2	6	6	6
	1/4	2.9	6	6	6
	1/3	3.6	6	10	10
	1/2	4.9	10	10	10
	3/4	6.9	15	15	15
	1	8	15	15	17.5
	1-1/2	10	15	20	20
	2	12	20	25	25
	3	17	25	30	35
	5	28	45	50	60
7-1/2	40	60	70	90	
10**	50	80	90	110	
<b>200 Vac, 3-phase</b>	1/2	2.5	6	6	6
	3/4	3.7	6	10	10
	1	4.8	10	10	10
	1-1/2	6.9	15	15	15
	2	7.8	15	15	17.5
	3	11	17.5	20	20
	5	17.5	30	35	35
	7-1/2	25.3	40	45	50
	20**	62.1	100	110	125
	25	78.2	125	150	175
	30	92	150	175	200
	40	120	200	225	250
50	150	225	300	300	
60	177	300	350	350	

**Note:** Use NEC code max column for low to moderate reverse/jog/plug applications.

\* Heavy Start permitted only if NEC code max does not allow motor start-up.

\*\*If equipment terminations are rated for 60°C conductors only, the 60°C conductor ampacities must be utilized and therefore larger conductor sizes or conduit sizes may be required.

Voltage	Motor size (Hp)	Motor FLA (amps)	Min (amps)	NEC code max (amps)	Heavy start* (amps)
<b>208 Vac, 3-phase</b>	1/2	2.4	6	6	6
	3/4	3.5	6	10	10
	1	4.6	10	10	10
	1-1/2	6.6	10	15	15
	2	7.5	15	15	15
	3	10.6	17.5	20	20
	5	16.7	25	30	35
	7-1/2	24.2	40	45	50
	20**	59.4	90	110	125
	25	74.8	125	150	150
	30	88	150	175	175
	40	114	175	200	250
50	143	225	300	300	
60	169	300	300	350	
<b>230 Vac, 3-phase</b>	1/2	2.2	6	6	6
	3/4	3.2	6	6	6
	1	4.2	10	10	10
	1-1/2	6	10	15	15
	2	6.8	15	15	15
	3	9.6	15	20	20
	5	15.2	25	30	30
	7-1/2	22	35	40	45
	20**	54	90	100	110
	25	68	110	125	150
	30	80	125	150	175
	40	104	175	200	225
50	130	200	250	250	
60	154	250	300	300	
75	192	300	350	400	
<b>460 Vac, 3-phase</b>	1/2	1.1	3	3	3
	3/4	1.6	3	3	3
	1	2.1	6	6	6
	1-1/2	3	6	6	6
	2	3.4	6	6	6
	3	4.8	10	10	10
	5	7.6	15	15	15
	7-1/2	11	17.5	20	20
	10	14	25	25	30
	15	21	35	40	45
	20	27	40	50	60
	50**	65	100	125	125
60	77	125	150	150	
75	96	150	175	200	
100	124	200	225	250	
125	156	250	300	350	
150	180	300	350	400	

**Note:** Use NEC code max column for low to moderate reverse/jog/plug applications.

\* Heavy Start permitted only if NEC code max does not allow motor start-up.

\*\*If equipment terminations are rated for 60°C conductors only, the 60°C conductor ampacities must be utilized and therefore larger conductor sizes or conduit sizes may be required.