

Microwave Switches Selection Guide

Failsafe



SPDT

Latching



High Power



DC to 40 GHz

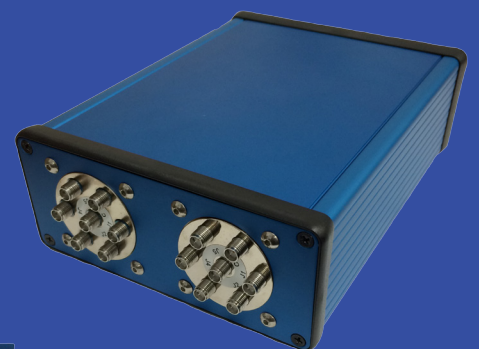

Transfer

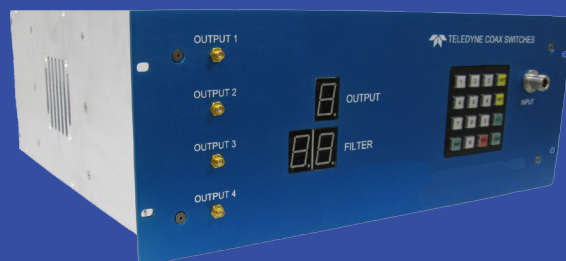

Low PIM



TELEDYNE
COAX SWITCHES
Everywhere you look™



RoHS or Non-RoHS:
Your Choice!



Industry Leader

With over 50 years experience, Teledyne is the world's innovative leader in manufacturing ultraminiature, hermetically sealed, electromechanical and solid-state switching products. Our comprehensive product line meets a wide range of requirements for industrial, commercial, medical, RF & wireless, defense and aerospace applications.

Product Assurance

Under an aggressive Total Quality Management (TQM) program, Teledyne has embraced a "continuous improvement" culture. With recognized certifications such as Boeing D6-82479, MIL-STD-790, AS/EN/ JISQ9100:2009 (Rev C) and ISO 9001:2008, Teledyne has become a primary supplier of switching solutions with the highest quality and reliability to industry leaders around the world.

Product Development

Teledyne offers a full range of comprehensive switching solutions. In addition to offering standard switching solutions, our experienced team works closely with our customers to develop tailored products for specific applications. We offer advanced engineering, state-of-the-art manufacturing techniques, and over 50 years of switching experience with a commitment to quality, costs and delivery.

Standard & Custom Matrix Assemblies

Teledyne offers a wide variety of RF matrix assemblies. Incorporating highly repeatable and long-cycle-life relays and switches, our matrices cover the spectrum from DC to 40GHz.

Teledyne's modular approach to building matrices allows assembly of a vast array of customized matrices with the same standard subassemblies. The internal components utilize Teledyne's proven switches. Our universal programmable microcontroller can be used for any matrix configuration. The universal power supply allows the matrix assembly to be used worldwide.

Low PIM Switches

Teledyne offers coaxial switches that have extremely low passive intermodulation for use in narrow bandwidth communication applications. The low PIM switches come in a variety configurations, such as, SPDT, Transfer and Multi-Throws.

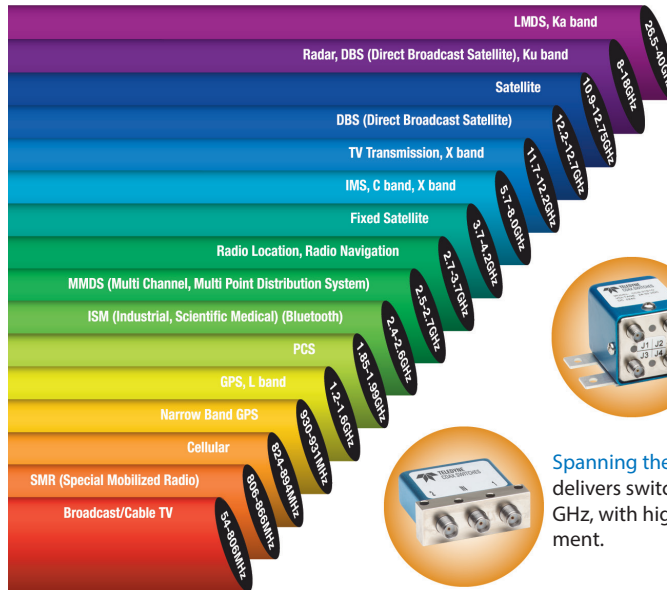

Spanning the Spectrum — Teledyne delivers switching solutions from DC to 40 GHz, with higher frequencies in development.

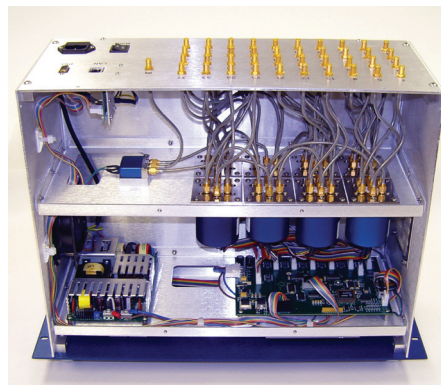

Matrix Assemblies — Teledyne provides matrix assemblies, such as the Model CSM-0003 1x40 Switch Matrix, that incorporate coaxial switches.

Featured switching solutions include:



Microwave Switch Matrix Assemblies

- Multiple standard and customized configurations
- Universal Power Supply
- Visual Display – LCD
- Standard and custom chassis available



CCR-40K DC-40 GHz SPDT Switch

- Excellent insertion loss repeatability
- Ultra low passive intermodulation (PIM)
- Characterized at 5 million cycles
- Compact design with 40 GHz performance



Space-Qualified Switches

Teledyne's space-qualified coaxial switches are typically custom-designed and manufactured according to specific performance requirements. We also provide a complete line of standard, off-the-shelf switches that offer customers significant cost savings, while satisfying most typical requirements for scientific, meteorological and communication satellite applications.

Technical Service & Customer Support

Teledyne provides easy access to technical service and customer support. Our website makes it easy to find technical information, buy products and even get e-mail responses within 24 hours. Switching solutions are only a mouse click away at www.teledynecoax.com.

Space-Qualified Switches

- Wide range of screening options available
- Custom designs to suit any application
- Proven heritage in space

Microwave Switches Product Guide

TABLE OF CONTENTS

SERIES OVERVIEW	1-14
PART NUMBERING SYSTEM	15
SPDT SWITCHES	16-21
TRANSFER/2P3T SWITCHES	22-25
MULTI-THROW SWITCHES	26-37
LOW PIM SWITCHES	38-46
POWER HANDLING VS FREQUENCY CHART	47
ADDITIONAL UNIQUE OPTIONS	48
GLOSSARY	49-50
CUSTOM MATRIX.....	51-52
MINI MATRIX.....	53-56
SERIES RF121/GRF121 RELAY.....	57
INDIUM PHOSPHIDE ACTIVE RF SWITCH.....	58
CUSTOM HYBRID SOLUTIONS.....	59
OTHER TELEDYNE PRODUCTS (<i>EMR, COAX, ISSR, MSSR, MATRIX, SPACE</i>)	60-65

RF121 / GRF121

- Broader bandwidth (DC - 18GHz)
- Signal integrity up to 40Gbps
- SPDT, Magnetic Latching
- Metal Enclosure for EMI shielding
- High Repeatability
- 3 Million Cycle Life



See Page 57

Indium Phosphide (Active RF Switch)

- Greater than 40Gbps bandwidth
- Broad frequency bandwidth, DC-60GHz
- Small form factor, 3mm X 3mm X 1 mm
- High linearity
- Low insertion loss
- Switching time of less than 100ns

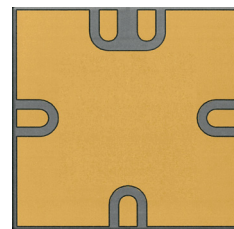

InP Series
See Page 58



Series (Commercial/Elite)		CCR-40K/CR-40K	CCR-33K/CR-33K	CCR-33S/CR-33S	CCR-53S/CR-53S
Configuration		SPDT	SPDT	SPDT	SPDT
Switch Function		Failsafe or Latching	Failsafe or Latching	Failsafe or Latching	Failsafe or Latching
Frequency	Commercial Model	DC to 40 GHz	DC to 33.5 GHz	DC to 18 GHz	DC to 26.5 GHz
	Elite Model	DC to 40 GHz	DC to 33.5 GHz	DC to 22 GHz	DC to 26.5 GHz
Coil Voltages Available		12, 15, 24, 28	12, 15, 24, 28	12, 15, 24, 28	12, 15, 24, 28
Connectors Available		2.92mm	2.92mm	SMA	SMA
Temperature Range	Commercial Model	-25°C to +65°C	-25°C to +65°C	-25°C to +65°C	-25°C to +65°C
	Elite Model	-50°C to +85°C	-50°C to +85°C	-50°C to +85°C	-50°C to +85°C
Typical Contact Life		5,000,000 cycles	5,000,000 cycles	5,000,000 cycles	5,000,000 cycles
Switch with Indicator Contacts		1,000,000 cycles	1,000,000 cycles	1,000,000 cycles	1,000,000 cycles
Typical RF Performance	VSWR (max)	DC-3 GHz : 1.25:1 3-6 GHz : 1.40:1 6-12 GHz : 1.50:1 12-18 GHz : 1.60:1 18-22 GHz : 1.80:1 22-27 GHz : 1.80:1 27-34 GHz : 1.80:1 34-40 GHz : 1.80:1	DC-6 GHz : 1.10:1 6-12 GHz : 1.10:1 12-18 GHz : 1.20:1 18-22 GHz : 1.30:1 22-26.5 GHz : 1.40:1 26.5-31 GHz : 1.70:1 31-33.5 GHz : 1.85:1	DC-3 GHz : 1.25:1 3-6 GHz : 1.25:1 6-12 GHz : 1.40:1 12-18 GHz : 1.50:1 18-22 GHz : 1.60:1	DC-3 GHz : 1.25:1 3-6 GHz : 1.25:1 6-12 GHz : 1.40:1 12-18 GHz : 1.50:1 18-22 GHz : 1.60:1 22-26.5 GHz : 1.80:1
	Insertion Loss (max)	DC-3 GHz : 0.20 dB 3-6 GHz : 0.20 dB 6-12 GHz : 0.40 dB 12-18 GHz : 0.50 dB 18-22 GHz : 0.60 dB 22-27 GHz : 0.60 dB 27-34 GHz : 0.70 dB 34-40 GHz : 0.80 dB	DC-6 GHz : 0.20 dB 6-12 GHz : 0.40 dB 12-18 GHz : 0.50 dB 18-22 GHz : 0.60 dB 22-26.5 GHz : 0.60 dB 26.5-31 GHz : 0.75 dB 31-33.5 GHz : 0.85 dB	DC-3 GHz : 0.20 dB 3-6 GHz : 0.20 dB 6-12 GHz : 0.40 dB 12-18 GHz : 0.50 dB 18-22 GHz : 0.60 dB	DC-3 GHz : 0.20 dB 3-6 GHz : 0.20 dB 6-12 GHz : 0.40 dB 12-18 GHz : 0.50 dB 18-22 GHz : 0.60 dB 22-26.5 GHz : 0.70 dB
	Isolation (min)	DC-3 GHz : 70 dB 3-6 GHz : 70 dB 6-12 GHz : 60 dB 12-18 GHz : 60 dB 18-22 GHz : 50 dB 22-27 GHz : 50 dB 27-34 GHz : 50 dB 34-40 GHz : 50 dB	DC-6 GHz : 70 dB 6-12 GHz : 70 dB 12-18 GHz : 70 dB 18-22 GHz : 50 dB 22-26.5 GHz : 50 dB 26.5-31 GHz : 40 dB 31-33.5 GHz : 40 dB	DC-3 GHz : 70 dB 3-6 GHz : 70 dB 6-12 GHz : 60 dB 12-18 GHz : 60 dB 18-22 GHz : 50 dB	DC-3 GHz : 70 dB 3-6 GHz : 70 dB 6-12 GHz : 60 dB 12-18 GHz : 60 dB 18-22 GHz : 50 dB 22-26.5 GHz : 50 dB
Options	Self Cutoff (Latching Only)	✓	✓	✓	✓
	Indicator Contacts	✓	✓	✓	✓
	Self Cutoff and Indicator Contacts (Latching Only)	✓	✓	✓	✓
	TTL Interface	✓	✓	✓	✓
	TTL Decoder	—	—	—	—
	Moisture Seal	✓	✓	✓	✓
	Narrow Body	✓	✓	✓	✓
	Coil Transient Suppression Diodes and Polarity Protection Diode	✓	✓	✓	✓
	Sub-D Connector	✓	✓	✓	✓
	See Page 16	See Page 17	See Page 17	See Page 17	



Series (Commercial/Elite)		CCRT-33/CRT-33	CCRT-53/CRT-53	CCR-33M/CR-33M	CCS-32/CS-32
Configuration		SPDT	SPDT	SPDT	SPDT
Switch Function		Failsafe or Latching	Failsafe or Latching	Failsafe or Latching	Failsafe or Latching
Frequency	Commercial Model	DC to 18 GHz	DC to 26.5 GHz	DC to 3 GHz	DC to 12 GHz
	Elite Model	DC to 22 GHz	DC to 26.5 GHz	–	DC to 12 GHz
Coil Voltages Available		12, 15, 24, 28	12, 15, 24, 28	12, 15, 24, 28	12, 15, 24, 28
Connectors Available		SMA	SMA	Mini-SMB	N, TNC
Temperature Range	Commercial Model	–25°C to +65°C	–25°C to +65°C	–25°C to +65°C	–25°C to +65°C
	Elite Model	–50°C to +85°C	–50°C to +85°C	–	–50°C to +85°C
Special Features		50-Ohm Internal Termination	50-Ohm Internal Termination	75-Ohm Impedance	High RF Power Handling
Typical Contact Life		5,000,000 cycles	5,000,000 cycles	5,000,000 cycles	3,000,000 cycles
Switch with Indicator Contacts		1,000,000 cycles	1,000,000 cycles	1,000,000 cycles	1,000,000 cycles
Typical RF Performance	VSWR (max)	DC–3 GHz : 1.25:1 3–6 GHz : 1.25:1 6–12 GHz : 1.40:1 12–18 GHz : 1.50:1 18–22 GHz : 1.60:1	DC–3 GHz : 1.25:1 3–6 GHz : 1.25:1 6–12 GHz : 1.40:1 12–18 GHz : 1.50:1 18–22 GHz : 1.60:1 22–26.5 GHz : 1.80:1	DC–1 GHz : 1.20:1 1–3 GHz : 1.30:1	DC–1 GHz : 1.25:1 1–4 GHz : 1.40:1 4–10 GHz : 1.70:1 10–12 GHz : 1.70:1
	Insertion Loss (max)	DC–3 GHz : 0.20 dB 3–6 GHz : 0.20 dB 6–12 GHz : 0.40 dB 12–18 GHz : 0.50 dB 18–22 GHz : 0.60 dB	DC–3 GHz : 0.20 dB 3–6 GHz : 0.20 dB 6–12 GHz : 0.40 dB 12–18 GHz : 0.50 dB 18–22 GHz : 0.60 dB 22–26.5 GHz : 0.70 dB	DC–1 GHz : 0.20 dB 1–3 GHz : 0.30 dB	DC–1 GHz : 0.30 dB 1–4 GHz : 0.40 dB 4–10 GHz : 0.50 dB 10–12 GHz : 0.50 dB
	Isolation (min)	DC–3 GHz : 70 dB 3–6 GHz : 70 dB 6–12 GHz : 60 dB 12–18 GHz : 60 dB 18–22 GHz : 50 dB	DC–3 GHz : 70 dB 3–6 GHz : 70 dB 6–12 GHz : 60 dB 12–18 GHz : 60 dB 18–22 GHz : 50 dB 22–26.5 GHz : 50 dB	DC–1 GHz : 70 dB 1–3 GHz : 65 dB	DC–1 GHz : 70 dB 1–4 GHz : 60 dB 4–10 GHz : 60 dB 10–12 GHz : 50 dB
Options	Self Cutoff (Latching Only)	✓	✓	✓	✓
	Indicator Contacts	✓	✓	✓	✓
	Self Cutoff and Indicator Contacts (Latching Only)	✓	✓	✓	✓
	TTL Interface	✓	✓	✓	✓
	TTL Decoder	–	–	–	–
	Moisture Seal	✓	✓	✓	✓
	Narrow Body	–	–	✓	–
	Coil Transient Suppression Diodes and Polarity Protection Diode	✓	✓	✓	✓
	Sub-D Connector	✓	✓	✓	✓
		See Page 19	See Page 19	See Page 20	See Page 21



Series (Commercial/Elite)		CCS-37K/CS-37K	CCS-37S/CS-37S	CCRS-33/CRS-33	CCRS-53/CRS-53
Configuration		Transfer Switch	Transfer Switch	2P3T	2P3T
Switch Function		Failsafe or Latching	Failsafe or Latching	Failsafe or Latching	Failsafe or Latching
Frequency	Commercial Model Elite Model	DC to 40 GHz DC to 40 GHz	DC to 18 GHz DC to 18 GHz	DC to 18 GHz DC to 22 GHz	DC to 26.5 GHz DC to 26.5 GHz
Coil Voltages Available		12, 15, 24, 28	12, 15, 24, 28	12, 15, 24, 28	12, 15, 24, 28
Connectors Available		2.92mm	SMA	SMA	SMA
Temperature Range	Commercial Model Elite Model	-25°C to +65°C -50°C to +85°C	-25°C to +65°C -50°C to +85°C	-25°C to +65°C -50°C to +85°C	-25°C to +65°C -50°C to +85°C
Typical Contact Life Switch with Indicator Contacts		2,000,000 cycles 1,000,000 cycles	5,000,000 cycles 1,000,000 cycles	5,000,000 cycles 1,000,000 cycles	5,000,000 cycles 1,000,000 cycles
Typical RF Performance	VSWR (max)	DC-6 GHz : 1.15:1 6-12 GHz : 1.20:1 12-18 GHz : 1.25:1 18-30 GHz : 1.50:1 30-33 GHz : 2.00:1 33-40 GHz : 2.50:1	DC-3 GHz : 1.25:1 3-6 GHz : 1.25:1 6-12 GHz : 1.40:1 12-18 GHz : 1.50:1	DC-3 GHz : 1.25:1 3-6 GHz : 1.25:1 6-12 GHz : 1.40:1 12-18 GHz : 1.50:1 18-22 GHz : 1.60:1	DC-3 GHz : 1.25:1 3-6 GHz : 1.25:1 6-12 GHz : 1.40:1 12-18 GHz : 1.50:1 18-22 GHz : 1.60:1 22-26.5 GHz : 1.80:1
	Insertion Loss (max)	DC-6 GHz : 0.15 dB 6-12 GHz : 0.25 dB 12-18 GHz : 0.35 dB 18-30 GHz : 0.55 dB 30-33 GHz : 1.00 dB 33-40 GHz : 1.35 dB	DC-3 GHz : 0.20 dB 3-6 GHz : 0.20 dB 6-12 GHz : 0.40 dB 12-18 GHz : 0.50 dB	DC-3 GHz : 0.20 dB 3-6 GHz : 0.20 dB 6-12 GHz : 0.40 dB 12-18 GHz : 0.50 dB 18-22 GHz : 0.60 dB	DC-3 GHz : 0.20 dB 3-6 GHz : 0.20 dB 6-12 GHz : 0.40 dB 12-18 GHz : 0.50 dB 18-22 GHz : 0.60 dB 22-26.5 GHz : 0.70 dB
	Isolation (min)	DC-6 GHz : 75 dB 6-12 GHz : 70 dB 12-18 GHz : 65 dB 18-30 GHz : 60 dB 30-36 GHz : 50 dB 33-40 GHz : 50 dB	DC-3 GHz : 70 dB 3-6 GHz : 70 dB 6-12 GHz : 60 dB 12-18 GHz : 60 dB	DC-3 GHz : 70 dB 3-6 GHz : 70 dB 6-12 GHz : 60 dB 12-18 GHz : 60 dB 18-22 GHz : 50 dB	DC-3 GHz : 70 dB 3-6 GHz : 70 dB 6-12 GHz : 60 dB 12-18 GHz : 60 dB 18-22 GHz : 50 dB 22-26.5 GHz : 50 dB
Options	Self Cutoff (Latching Only)	✓	✓	✓	✓
	Indicator Contacts	✓	✓	✓	✓
	Self Cutoff and Indicator Contacts (Latching Only)	✓	✓	✓	✓
	TTL Interface	✓	✓	✓	✓
	TTL Decoder	—	—	—	—
	Moisture Seal	✓	✓	✓	✓
	Narrow Body	—	—	—	—
	Coil Transient Suppression Diodes and Polarity Protection Diode	✓	✓	✓	✓
Sub-D Connector	✓	✓	✓	✓	
		See Page 22	See Page 23	See Page 24	See Page 24

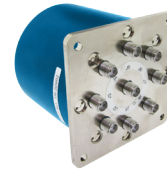

Series (Commercial/Elite)		CCS-47/CS-47	CCR-48K/CR-48K	CCR-38/CR-38	CCR-38/CR-38
Configuration		Transfer Switch	SP3T to SP6T	SP3T to SP6T	SP7T to SP8T
Switch Function		Failsafe or Latching	Normally Open	Normally Open	Normally Open
Frequency	Commercial Model Elite Model	DC to 12 GHz DC to 12 GHz	DC to 40 GHz DC to 40 GHz	DC to 18 GHz DC to 22 GHz	DC to 12 GHz DC to 12 GHz
Coil Voltages Available		12, 15, 24, 28	12, 15, 24, 28	12, 15, 24, 28	12, 15, 24, 28
Connectors Available		TNC, N	2.92mm	SMA	SMA
Temperature Range	Commercial Model Elite Model	-25°C to +65°C -50°C to +85°C	-25°C to +65°C -50°C to +85°C	-25°C to +65°C -50°C to +85°C	-25°C to +65°C -40°C to +85°C
Typical Contact Life		3,000,000 cycles	5,000,000 cycles	5,000,000 cycles	3,000,000 cycles
Switch with Indicator Contacts		1,000,000 cycles	1,000,000 cycles	1,000,000 cycles	1,000,000 cycles
Typical RF Performance	VSWR (max)	DC-1 GHz : 1.25:1 1-4 GHz : 1.40:1 4-12 GHz : 1.80:1	DC-6 GHz : 1.25:1 6-12 GHz : 1.40:1 12-18 GHz : 1.50:1 18-28 GHz : 1.80:1 28-34 GHz : 1.90:1 34-40 GHz : 2.10:1	DC-3 GHz : 1.25:1 3-6 GHz : 1.25:1 6-12 GHz : 1.40:1 12-18 GHz : 1.50:1 18-22 GHz : 1.80:1	DC-3 GHz : 1.30:1 3-6 GHz : 1.30:1 6-12 GHz : 1.40:1
	Insertion Loss (max)	DC-1 GHz : 0.30 dB 1-4 GHz : 0.40 dB 4-12 GHz : 0.50 dB	DC-6 GHz : 0.20 dB 6-12 GHz : 0.40 dB 12-18 GHz : 0.50 dB 18-28 GHz : 0.60 dB 28-34 GHz : 1.00 dB 34-40 GHz : 1.50 dB	DC-3 GHz : 0.20 dB 3-6 GHz : 0.20 dB 6-12 GHz : 0.40 dB 12-18 GHz : 0.50 dB 18-22 GHz : 0.60 dB	DC-3 GHz : 0.20 dB 3-6 GHz : 0.20 dB 6-12 GHz : 0.40 dB
	Isolation (min)	DC-1 GHz : 70 dB 1-4 GHz : 60 dB 4-12 GHz : 60 dB	DC-6 GHz : 70 dB 6-12 GHz : 60 dB 12-18 GHz : 60 dB 18-28 GHz : 50 dB 28-34 GHz : 50 dB 34-40 GHz : 50 dB	DC-3 GHz : 70 dB 3-6 GHz : 70 dB 6-12 GHz : 60 dB 12-18 GHz : 60 dB 18-22 GHz : 50 dB	DC-3 GHz : 70 dB 3-6 GHz : 70 dB 6-12 GHz : 60 dB
Options	Self Cutoff (Latching Only)	✓	—	—	—
	Indicator Contacts	✓	✓	✓	✓
	Self Cutoff and Indicator Contacts (Latching Only)	✓	—	—	—
	TTL Interface	✓	✓	✓	✓
	TTL Decoder	—	—	✓	✓
	Moisture Seal	✓	✓	✓	✓
	Narrow Body	—	—	—	—
	Coil Transient Suppression Diodes and Polarity Protection Diode	✓	✓	✓	✓
Sub-D Connector	✓	✓	✓	✓	
		See Page 25	See Page 26	See Page 27	See Page 27

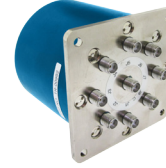

Series (Commercial/Elite)		CCR-38/CR-38S	CCR-58/CR-58	CCR-58/CR-58	CCR-58/CR-58
Configuration		SP9T to SP10T	SP3T to SP6T	SP7T to SP8T	SP9T to SP10T
Switch Function		Normally Open	Normally Open	Normally Open	Normally Open
Frequency	Commercial Model	DC to 10 GHz	DC to 26.5 GHz	DC to 18 GHz	DC to 18 GHz
	Elite Model	DC to 10 GHz	DC to 26.5 GHz	DC to 18 GHz	DC to 18 GHz
Coil Voltages Available		12, 15, 24, 28	12, 15, 24, 28	12, 15, 24, 28	12, 15, 24, 28
Connectors Available		SMA	SMA	SMA	SMA
Temperature Range	Commercial Model	-25°C to +65°C	-25°C to +65°C	-25°C to +65°C	-25°C to +65°C
	Elite Model	-40°C to +85°C	-50°C to +85°C	-40°C to +85°C	-40°C to +85°C
Typical Contact Life		3,000,000 cycles	5,000,000 cycles	3,000,000 cycles	3,000,000 cycles
Switch with Indicator Contacts		1,000,000 cycles	1,000,000 cycles	1,000,000 cycles	1,000,000 cycles
Typical RF Performance	VSWR (max)	DC–2 GHz : 1.20:1 2–4 GHz : 1.30:1 4–8 GHz : 1.40:1 8–10 GHz : 1.50:1	DC–3 GHz : 1.25:1 3–6 GHz : 1.25:1 6–12 GHz : 1.40:1 12–18 GHz : 1.50:1 18–22 GHz : 1.80:1 22–26.5 GHz : 1.80:1	DC–3 GHz : 1.30:1 3–6 GHz : 1.30:1 6–12 GHz : 1.40:1 12–18 GHz : 1.60:1	DC–2 GHz : 1.20:1 2–4 GHz : 1.30:1 4–8 GHz : 1.40:1 8–12 GHz : 1.50:1 12–18 GHz : 1.70:1
	Insertion Loss (max)	DC–2 GHz : 0.20 dB 2–4 GHz : 0.30 dB 4–8 GHz : 0.40 dB 8–10 GHz : 0.50 dB	DC–3 GHz : 0.20 dB 3–6 GHz : 0.20 dB 6–12 GHz : 0.40 dB 12–18 GHz : 0.50 dB 18–22 GHz : 0.60 dB 22–26.5 GHz : 0.80 dB	DC–3 GHz : 0.20 dB 3–6 GHz : 0.20 dB 6–12 GHz : 0.40 dB 12–18 GHz : 0.50 dB	DC–2 GHz : 0.20 dB 2–4 GHz : 0.30 dB 4–8 GHz : 0.40 dB 8–12 GHz : 0.50 dB 12–18 GHz : 0.70 dB
	Isolation (min)	DC–2 GHz : 80 dB 2–4 GHz : 75 dB 4–8 GHz : 70 dB 8–10 GHz : 65 dB	DC–3 GHz : 70 dB 3–6 GHz : 70 dB 6–12 GHz : 60 dB 12–18 GHz : 60 dB 18–22 GHz : 50 dB 22–26.5 GHz : 50 dB	DC–3 GHz : 70 dB 3–6 GHz : 70 dB 6–12 GHz : 60 dB 12–18 GHz : 60 dB	DC–2 GHz : 80 dB 2–4 GHz : 75 dB 4–8 GHz : 70 dB 8–12 GHz : 65 dB 12–18 GHz : 60 dB
Options	Self Cutoff (Latching Only)	—	—	—	—
	Indicator Contacts	✓	✓	✓	✓
	Self Cutoff and Indicator Contacts (Latching Only)	—	—	—	—
	TTL Interface	✓	✓	✓	✓
	TTL Decoder	✓	✓	✓	✓
	Moisture Seal	✓	✓	✓	✓
	Narrow Body	—	—	—	—
	Coil Transient Suppression Diodes and Polarity Protection Diode	✓	✓	✓	✓
Sub-D Connector	✓	✓	✓	✓	
		See Page 27	See Page 28	See Page 28	See Page 28



Series (Commercial/Elite)		CCS-18/CS-18	CCS-18/CS-18	CCT-48K/CT-48K	CCT-38/CT-38
Configuration		SP3T to SP6T	SP7T to SP8T	SP3T to SP6T	SP3T to SP6T
Switch Function		Normally Open	Normally Open	Normally Open	Normally Open
Frequency	Commercial Model	DC to 12 GHz	DC to 8 GHz	DC to 40 GHz	DC to 18 GHz
	Elite Model	DC to 12 GHz	DC to 8 GHz	DC to 40 GHz	DC to 22 GHz
Coil Voltages Available		12, 15, 24, 28	12, 15, 24, 28	12, 15, 24, 28	12, 15, 24, 28
Connectors Available		N, TNC	N, TNC	2.92mm	SMA
Temperature Range	Commercial Model	-25°C to +65°C	-25°C to +65°C	-25°C to +65°C	-25°C to +65°C
	Elite Model	-50°C to +85°C	-50°C to +85°C	-50°C to +85°C	-50°C to +85°C
Typical Contact Life Switch with Indicator Contacts		3,000,000 cycles 1,000,000 cycles	3,000,000 cycles 1,000,000 cycles	5,000,000 cycles 1,000,000 cycles	5,000,000 cycles 1,000,000 cycles
Typical RF Performance	VSWR (max)	DC-1 GHz : 1.25:1 1-4 GHz : 1.40:1 4-12 GHz : 1.70:1	DC-1 GHz : 1.25:1 1-4 GHz : 1.40:1 4-8 GHz : 1.70:1	DC-6 GHz : 1.25:1 6-12 GHz : 1.30:1 12-18 GHz : 1.50:1 18-28 GHz : 1.60:1 28-35 GHz : 1.80:1 35-40 GHz : 2.10:1	DC-3 GHz : 1.25:1 3-6 GHz : 1.25:1 6-12 GHz : 1.40:1 12-18 GHz : 1.40:1 18-22 GHz : 1.80:1
	Insertion Loss (max)	DC-1 GHz : 0.30 dB 1-4 GHz : 0.40 dB 4-12 GHz : 0.50 dB	DC-1 GHz : 0.30 dB 1-4 GHz : 0.40 dB 4-8 GHz : 0.50 dB	DC-6 GHz : 0.20 dB 6-12 GHz : 0.30 dB 12-18 GHz : 0.40 dB 18-28 GHz : 0.60 dB 28-35 GHz : 1.00 dB 35-40 GHz : 1.40 dB	DC-3 GHz : 0.20 dB 3-6 GHz : 0.20 dB 6-12 GHz : 0.40 dB 12-18 GHz : 0.50 dB 18-22 GHz : 0.60 dB
	Isolation (min)	DC-1 GHz : 70 dB 1-4 GHz : 60 dB 4-12 GHz : 60 dB	DC-1 GHz : 70 dB 1-4 GHz : 60 dB 4-8 GHz : 60 dB	DC-6 GHz : 75 dB 6-12 GHz : 75 dB 12-18 GHz : 70 dB 18-28 GHz : 70 dB 28-35 GHz : 60 dB 35-40 GHz : 60 dB	DC-3 GHz : 70 dB 3-6 GHz : 70 dB 6-12 GHz : 60 dB 12-18 GHz : 60 dB 18-22 GHz : 50 dB
Options	Self Cutoff (Latching Only)	—	—	—	—
	Indicator Contacts	✓	✓	✓	✓
	Self Cutoff and Indicator Contacts (Latching Only)	—	—	—	—
	TTL Interface	✓	✓	✓	✓
	TTL Decoder	✓	✓	—	✓
	Moisture Seal	✓	✓	✓	✓
	Narrow Body	—	—	—	—
	Coil Transient Suppression Diodes and Polarity Protection Diode	✓	✓	✓	✓
Sub-D Connector	✓	✓	✓	✓	
		See Page 31	See Page 31	See Page 26	See Page 27



Series (Commercial/Elite)		CCT-38/CT-38	CCT-38/CT-38	CCT-58/CT-58	CCT-58/CT-58
Configuration		SP7T to SP8T	SP9T to SP10T	SP3T to SP6T	SP7T to SP8T
Switch Function		Normally Open	Normally Open	Normally Open	Normally Open
Frequency	Commercial Model	DC to 12 GHz	DC to 10 GHz	DC to 26.5 GHz	DC to 18 GHz
	Elite Model	DC to 12 GHz	DC to 10 GHz	DC to 26.5 GHz	DC to 18 GHz
Coil Voltages Available		12, 15, 24, 28	12, 15, 24, 28	12, 15, 24, 28	12, 15, 24, 28
Connectors Available		SMA	SMA	SMA	SMA
Temperature Range	Commercial Model	-25°C to +65°C	-25°C to +65°C	-25°C to +65°C	-25°C to +65°C
	Elite Model	-40°C to +85°C	-40°C to +85°C	-50°C to +85°C	-40°C to +85°C
Typical Contact Life		3,000,000 cycles	3,000,000 cycles	5,000,000 cycles	3,000,000 cycles
Switch with Indicator Contacts		1,000,000 cycles	1,000,000 cycles	1,000,000 cycles	1,000,000 cycles
Typical RF Performance	VSWR (max)	DC-3 GHz : 1.30:1 3-6 GHz : 1.30:1 6-12 GHz : 1.40:1	DC-2 GHz : 1.15:1 2-4 GHz : 1.30:1 4-8 GHz : 1.35:1 8-10 GHz : 1.40:1	DC-3 GHz : 1.25:1 3-6 GHz : 1.25:1 6-12 GHz : 1.40:1 12-18 GHz : 1.50:1 18-22 GHz : 1.80:1 22-26.5 GHz : 1.80:1	DC-3 GHz : 1.30:1 3-6 GHz : 1.30:1 6-12 GHz : 1.40:1 12-18 GHz : 1.60:1
	Insertion Loss (max)	DC-3 GHz : 0.20 dB 3-6 GHz : 0.20 dB 6-12 GHz : 0.40 dB	DC-2 GHz : 0.15 dB 2-4 GHz : 0.30 dB 4-8 GHz : 0.40 dB 8-10 GHz : 0.50 dB	DC-3 GHz : 0.20 dB 3-6 GHz : 0.20 dB 6-12 GHz : 0.40 dB 12-18 GHz : 0.50 dB 18-22 GHz : 0.60 dB 22-26.5 GHz : 0.80 dB	DC-3 GHz : 0.20 dB 3-6 GHz : 0.20 dB 6-12 GHz : 0.40 dB 12-18 GHz : 0.50 dB
	Isolation (min)	DC-3 GHz : 70 dB 3-6 GHz : 70 dB 6-12 GHz : 60 dB	DC-2 GHz : 80 dB 2-4 GHz : 75 dB 4-8 GHz : 70 dB 8-10 GHz : 65 dB	DC-3 GHz : 70 dB 3-6 GHz : 70 dB 6-12 GHz : 60 dB 12-18 GHz : 60 dB 18-22 GHz : 50 dB 22-26.5 GHz : 50 dB	DC-3 GHz : 70 dB 3-6 GHz : 70 dB 6-12 GHz : 60 dB 12-18 GHz : 60 dB
Options	Self Cutoff (Latching Only)	—	—	—	—
	Indicator Contacts	✓	✓	✓	✓
	Self Cutoff and Indicator Contacts (Latching Only)	—	—	—	—
	TTL Interface	✓	✓	✓	✓
	TTL Decoder	✓	✓	✓	✓
	Moisture Seal	✓	✓	✓	✓
	Narrow Body	—	—	—	—
	Coil Transient Suppression Diodes and Polarity Protection Diode	✓	✓	✓	✓
Sub-D Connector	✓	✓	✓	✓	
		See Page 27	See Page 27	See Page 28	See Page 28



Series (Commercial/Elite)		CCT-58/CT-58	CCR-49K/CR-49K	CCR-39/CR-39	CCR-39/CR-39
Configuration		SP9T to SP10T	SP3T to SP6T	SP3T to SP6T	SP7T to SP8T
Switch Function		Normally Open	Latching	Latching	Latching
Frequency	Commercial Model Elite Model	DC to 18 GHz DC to 18 GHz	DC to 40 GHz DC to 40 GHz	DC to 18 GHz DC to 22 GHz	DC to 12 GHz DC to 12 GHz
Coil Voltages Available		12, 15, 24, 28	12, 15, 24, 28	12, 15, 24, 28	12, 15, 24, 28
Connectors Available		SMA	2.92mm	SMA	SMA
Temperature Range	Commercial Model Elite Model	-25°C to +65°C -40°C to +85°C	-25°C to +65°C -50°C to +85°C	-25°C to +65°C -50°C to +85°C	-25°C to +65°C -40°C to +85°C
Typical Contact Life		3,000,000 cycles	5,000,000 cycles	5,000,000 cycles	3,000,000 cycles
Switch with Indicator Contacts		1,000,000 cycles	1,000,000 cycles	1,000,000 cycles	1,000,000 cycles
Typical RF Performance	VSWR (max)	DC-2 GHz : 1.15:1 2-4 GHz : 1.30:1 4-8 GHz : 1.35:1 8-12 GHz : 1.40:1 12-18 GHz : 1.60:1	DC-6 GHz : 1.25:1 6-12 GHz : 1.30:1 12-18 GHz : 1.60:1 18-26.5 GHz : 1.70:1 26.5-32 GHz : 1.80:1 32-40 GHz : 1.95:1	DC-3 GHz : 1.25:1 3-6 GHz : 1.25:1 6-12 GHz : 1.40:1 12-18 GHz : 1.50:1 18-22 GHz : 1.80:1	DC-3 GHz : 1.30:1 3-6 GHz : 1.30:1 6-12 GHz : 1.40:1
	Insertion Loss (max)	DC-2 GHz : 0.15 dB 2-4 GHz : 0.30 dB 4-8 GHz : 0.40 dB 8-12 GHz : 0.50 dB 12-18 GHz : 0.70 dB	DC-6 GHz : 0.20 dB 6-12 GHz : 0.30 dB 12-18 GHz : 0.60 dB 18-26.5 GHz : 0.80 dB 26.5-32 GHz : 0.80 dB 32-40 GHz : 1.40 dB	DC-3 GHz : 0.20 dB 3-6 GHz : 0.20 dB 6-12 GHz : 0.40 dB 12-18 GHz : 0.50 dB 18-22 GHz : 0.60 dB	DC-3 GHz : 0.20 dB 3-6 GHz : 0.20 dB 6-12 GHz : 0.40 dB
	Isolation (min)	DC-2 GHz : 80 dB 2-4 GHz : 75 dB 4-8 GHz : 70 dB 8-12 GHz : 65 dB 12-18 GHz : 60 dB	DC-6 GHz : 80 dB 6-12 GHz : 75 dB 12-18 GHz : 70 dB 18-26.5 GHz : 70 dB 26.5-32 GHz : 60 dB 32-40 GHz : 60 dB	DC-3 GHz : 70 dB 3-8 GHz : 70 dB 8-12 GHz : 60 dB 12-16 GHz : 60 dB 16-20 GHz : 50 dB 20-22 GHz : 50 dB	DC-3 GHz : 70 dB 3-6 GHz : 70 dB 6-12 GHz : 60 dB
	Self Cutoff (Latching Only)	—	✓	✓	✓
Options	Indicator Contacts	✓	✓	✓	✓
	Self Cutoff and Indicator Contacts (Latching Only)	—	✓	✓	✓
	TTL Interface	✓	✓	✓	✓
	TTL Decoder	✓	✓	✓	✓
	Moisture Seal	✓	✓	✓	✓
	Narrow Body	—	—	—	—
	Coil Transient Suppression Diodes and Polarity Protection Diode	✓	✓	✓	✓
	Sub-D Connector	✓	✓	✓	✓
		See Page 28	See Page 32	See Page 33	See Page 33



RoHS or Non-RoHS:
Your Choice!



Series (Commercial/Elite)		CCR-39/CR-39	CCR-59/CR-59	CCR-59/CR-59	CCR-59/CR-59
Configuration		SP9T to SP10T	SP3T to SP6T	SP7T to SP8T	SP9T to SP10T
Switch Function		Latching	Latching	Latching	Latching
Frequency	Commercial Model Elite Model	DC to 12 GHz DC to 12 GHz	DC to 26.5 GHz DC to 26.5 GHz	DC to 18 GHz DC to 18 GHz	DC to 18 GHz DC to 18 GHz
Coil Voltages Available		12, 15, 24, 28	12, 15, 24, 28	12, 15, 24, 28	12, 15, 24, 28
Connectors Available		SMA	SMA	SMA	SMA
Temperature Range	Commercial Model Elite Model	-25°C to +65°C -40°C to +85°C	-25°C to +65°C -50°C to +85°C	-25°C to +65°C -40°C to +85°C	-25°C to +65°C -40°C to +85°C
Typical Contact Life		3,000,000 cycles	5,000,000 cycles	3,000,000 cycles	3,000,000 cycles
Switch with Indicator Contacts		1,000,000 cycles	1,000,000 cycles	1,000,000 cycles	1,000,000 cycles
Typical RF Performance	VSWR (max)	DC-2 GHz : 1.15:1 2-4 GHz : 1.30:1 4-8 GHz : 1.35:1 8-12 GHz : 1.40:1	DC-3 GHz : 1.25:1 3-6 GHz : 1.25:1 6-12 GHz : 1.40:1 12-18 GHz : 1.50:1 18-22 GHz : 1.80:1 22-26.5 GHz : 1.80:1	DC-3 GHz : 1.30:1 3-6 GHz : 1.30:1 6-12 GHz : 1.40:1 12-18 GHz : 1.60:1	DC-2 GHz : 1.15:1 2-4 GHz : 1.30:1 4-8 GHz : 1.35:1 8-12 GHz : 1.40:1 12-18 GHz : 1.60:1
	Insertion Loss (max)	DC-2 GHz : 0.15 dB 2-4 GHz : 0.30 dB 4-8 GHz : 0.40 dB 8-12 GHz : 0.50 dB	DC-3 GHz : 0.20 dB 3-6 GHz : 0.20 dB 6-12 GHz : 0.40 dB 12-18 GHz : 0.50 dB 18-22 GHz : 0.60 dB 22-26.5 GHz : 0.80 dB	DC-3 GHz : 0.20 dB 3-6 GHz : 0.20 dB 6-12 GHz : 0.40 dB 12-18 GHz : 0.50 dB	DC-2 GHz : 0.15 dB 2-4 GHz : 0.30 dB 4-8 GHz : 0.40 dB 8-12 GHz : 0.50 dB 12-18 GHz : 0.70 dB
	Isolation (min)	DC-2 GHz : 80 dB 2-4 GHz : 75 dB 4-8 GHz : 70 dB 8-12 GHz : 65 dB	DC-3 GHz : 70 dB 3-6 GHz : 70 dB 6-12 GHz : 60 dB 12-18 GHz : 60 dB 18-22 GHz : 50 dB 22-26.5 GHz : 50 dB	DC-3 GHz : 70 dB 3-6 GHz : 70 dB 6-12 GHz : 60 dB 12-18 GHz : 60 dB	DC-2 GHz : 80 dB 2-4 GHz : 75 dB 4-8 GHz : 70 dB 8-12 GHz : 65 dB 12-18 GHz : 60 dB
Options	Self Cutoff (Latching Only)	✓	✓	—	—
	Indicator Contacts	✓	✓	✓	✓
	Self Cutoff and Indicator Contacts (Latching Only)	✓	✓	—	—
	TTL Interface	✓	✓	✓	✓
	TTL Decoder	✓	✓	✓	✓
	Moisture Seal	✓	✓	✓	✓
	Narrow Body	—	—	—	—
	Coil Transient Suppression Diodes and Polarity Protection Diode	✓	✓	✓	✓
Sub-D Connector	✓	✓	✓	✓	
		See Page 33	See Page 34	See Page 34	See Page 34

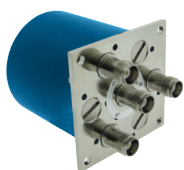

Series (Commercial/Elite)		CCS-19/CS-19	CCT-49K/CT-49K	CCT-39/CT-39	CCT-39/CT-39
Configuration		SP3T to SP6T	SP3T to SP6T	SP3T to SP6T	SP7T to SP8T
Switch Function		Latching	Latching	Latching	Latching
Frequency	Commercial Model Elite Model	DC to 2 GHz DC to 2 GHz	DC to 40 GHz DC to 40 GHz	DC to 18 GHz DC to 22 GHz	DC to 12 GHz DC to 12 GHz
Coil Voltages Available		12, 15, 24, 28	12, 15, 24, 28	12, 15, 24, 28	12, 15, 24, 28
Connectors Available		N, TNC	2.92mm	SMA	SMA
Temperature Range	Commercial Model Elite Model	-25°C to +65°C -50°C to +85°C	-25°C to +65°C -50°C to +85°C	-25°C to +65°C -50°C to +85°C	-25°C to +65°C -40°C to +85°C
Typical Contact Life Switch with Indicator Contacts		3,000,000 cycles 1,000,000 cycles	5,000,000 cycles 1,000,000 cycles	5,000,000 cycles 1,000,000 cycles	3,000,000 cycles 1,000,000 cycles
Typical RF Performance	VSWR (max)	DC-1 GHz : 1.15:1 1-2 GHz : 1.20:1	DC-6 GHz : 1.25:1 6-12 GHz : 1.30:1 12-18 GHz : 1.60:1 18-26.5 GHz : 1.70:1 26.5-32 GHz : 1.80:1 32-40 GHz : 1.95:1	DC-3 GHz : 1.25:1 3-6 GHz : 1.25:1 6-12 GHz : 1.40:1 12-18 GHz : 1.50:1 18-22 GHz : 1.80:1	DC-3 GHz : 1.30:1 3-6 GHz : 1.30:1 6-12 GHz : 1.40:1
	Insertion Loss (max)	DC-1 GHz : 0.7 dB 1-2 GHz : 0.9 dB	DC-6 GHz : 0.20 dB 6-12 GHz : 0.30 dB 12-18 GHz : 0.60 dB 18-26.5 GHz : 0.80 dB 26.5-32 GHz : 1.00 dB 32-40 GHz : 1.40 dB	DC-3 GHz : 0.20 dB 3-6 GHz : 0.20 dB 6-12 GHz : 0.40 dB 12-18 GHz : 0.50 dB 18-22 GHz : 0.60 dB	DC-3 GHz : 0.20 dB 3-6 GHz : 0.20 dB 6-12 GHz : 0.40 dB
	Isolation (min)	DC-1 GHz : 80 dB 1-2 GHz : 80 dB	DC-6 GHz : 80 dB 6-12 GHz : 75 dB 12-18 GHz : 70 dB 18-26.5 GHz : 70 dB 26.5-32 GHz : 60 dB 32-40 GHz : 60 dB	DC-3 GHz : 70 dB 3-6 GHz : 70 dB 6-12 GHz : 60 dB 12-18 GHz : 60 dB 18-22 GHz : 50 dB	DC-3 GHz : 70 dB 3-6 GHz : 70 dB 6-12 GHz : 60 dB
Options	Self Cutoff (Latching Only)	—	✓	✓	✓
	Indicator Contacts	✓	✓	✓	✓
	Self Cutoff and Indicator Contacts (Latching Only)	—	✓	✓	✓
	TTL Interface	✓	✓	✓	✓
	TTL Decoder	✓	✓	✓	✓
	Moisture Seal	✓	✓	✓	✓
	Narrow Body	—	—	—	—
	Coil Transient Suppression Diodes and Polarity Protection Diode	✓	✓	✓	✓
Sub-D Connector	✓	✓	✓	✓	
		See Page 37	See Page 32	See Page 33	See Page 33



RoHS or Non-RoHS:
Your Choice!



Series (Commercial)		CCT-39/CT-39	CCT-59/CT-59	CCT-59/CT-59	CCT-59/CT-59
Configuration		SP9T to SP10T	SP3T to SP6T	SP7T to SP8T	SP9T to SP10T
Switch Function		Latching	Latching	Latching	Latching
Frequency	Commercial Model	DC to 12 GHz DC to 12 GHz	DC to 26.5 GHz DC to 26.5 GHz	DC to 18 GHz DC to 18 GHz	DC to 18 GHz DC to 18 GHz
Coil Voltages Available		12, 15, 24, 28	12, 15, 24, 28	12, 15, 24, 28	12, 15, 24, 28
Connectors Available		SMA	SMA	SMA	SMA
Temperature Range	Commercial Model	-25°C to +65°C -40°C to +85°C	-25°C to +65°C -50°C to +85°C	-25°C to +65°C -40°C to +85°C	-25°C to +65°C -40°C to +85°C
Typical Contact Life		3,000,000 cycles	5,000,000 cycles	3,000,000 cycles	3,000,000 cycles
Switch with Indicator Contacts		1,000,000 cycles	1,000,000 cycles	1,000,000 cycles	1,000,000 cycles
Passive Intermodulation Characteristics	3rd Order Intermodulation	DC-2 GHz : 1.15:1 2-4 GHz : 1.30:1 4-8 GHz : 1.35:1 8-12 GHz : 1.40:1	DC-3 GHz : 1.25:1 3-6 GHz : 1.25:1 6-12 GHz : 1.40:1 12-18 GHz : 1.50:1 18-22 GHz : 1.80:1 22-26.5 GHz : 1.80:1	DC-3 GHz : 1.30:1 3-6 GHz : 1.30:1 6-12 GHz : 1.40:1 12-18 GHz : 1.60:1	DC-2 GHz : 1.15:1 2-4 GHz : 1.30:1 4-8 GHz : 1.35:1 8-12 GHz : 1.40:1 12-18 GHz : 1.60:1
	Tone 1 Frequency	DC-2 GHz : 0.15 dB 2-4 GHz : 0.30 dB 4-8 GHz : 0.40 dB 8-12 GHz : 0.50 dB	DC-3 GHz : 0.20 dB 3-6 GHz : 0.20 dB 6-12 GHz : 0.40 dB 12-18 GHz : 0.40 dB 18-22 GHz : 0.60 dB 22-26.5 GHz : 0.80 dB	DC-3 GHz : 0.20 dB 3-6 GHz : 0.20 dB 6-12 GHz : 0.40 dB 12-18 GHz : 0.50 dB	DC-2 GHz : 0.15 dB 2-4 GHz : 0.30 dB 4-8 GHz : 0.40 dB 8-12 GHz : 0.50 dB 12-18 GHz : 0.70 dB
	Tone 2 Frequency	DC-2 GHz : 80 dB 2-4 GHz : 75 dB 4-8 GHz : 70 dB 8-12 GHz : 65 dB	DC-3 GHz : 70 dB 3-6 GHz : 70 dB 6-12 GHz : 60 dB 12-18 GHz : 60 dB 18-22 GHz : 50 dB 22-26.5 GHz : 50 dB	DC-3 GHz : 70 dB 3-6 GHz : 70 dB 6-12 GHz : 60 dB 12-18 GHz : 60 dB	DC-2 GHz : 80 dB 2-4 GHz : 75 dB 4-8 GHz : 70 dB 8-12 GHz : 65 dB 12-18 GHz : 60 dB
Options	Self Cutoff (Latching Only)	✓	✓	✓	✓
	Indicator Contacts	✓	✓	✓	✓
	Self Cutoff and Indicator Contacts (Latching Only)	✓	✓	✓	✓
	TTL Interface	✓	✓	✓	✓
	TTL Decoder	✓	✓	✓	✓
	Moisture Seal	✓	✓	✓	✓
	Narrow Body	—	—	—	—
	Coil Transient Suppression Diodes and Polarity Protection Diode	✓	✓	✓	✓
Sub-D Connector	✓	✓	✓	✓	
		See Page 33	See Page 34	See Page 34	See Page 34



Series (Commercial)		CCP-32N	CCP-33S	CCP-33D	CCP-37S
Configuration		SPDT	SPDT	SPDT	Transfer Switch
Switch Function		Latching	Latching	Latching	Latching
Frequency	Commercial Model	DC to 3 GHz	DC to 3 GHz	DC to 3 GHz	DC to 3 GHz
Coil Voltages Available		12, 15, 24, 28	12, 15, 24, 28	12, 15, 24, 28	12, 15, 24, 28
Connectors Available		N	SMA	7/16 DIN	SMA
Temperature Range	Commercial Model	-25°C to +65°C	-25°C to +65°C	-25°C to +65°C	-25°C to +65°C
Typical Contact Life		1,000,000 cycles	1,000,000 cycles	1,000,000 cycles	1,000,000 cycles
Switch with Indicator Contacts		1,000,000 cycles	1,000,000 cycles	1,000,000 cycles	1,000,000 cycles
Passive Intermodulation Characteristics	3rd Order Intermodulation	1900 MHz -142.2 dBc Peak PIM	1900 MHz -142.2 dBc Peak PIM	1900 MHz -165.6 dBc Peak PIM	1900 MHz -146.7 dBc Peak PIM
	Tone 1 Frequency	1945 MHz @ 43 dBm	1945 MHz @ 43 dBm	1945 MHz @ 43 dBm	1945 MHz @ 43 dBm
	Tone 2 Frequency	1990 MHz @ 43 dBm	1990 MHz @ 43 dBm	1990 MHz @ 43 dBm	1990 MHz @ 43 dBm
Options	Self Cutoff (Latching Only)	✓	✓	✓	✓
	Indicator Contacts	✓	✓	✓	✓
	Self Cutoff and Indicator Contacts (Latching Only)	✓	✓	✓	✓
	TTL Interface	✓	✓	✓	✓
	TTL Decoder	—	—	—	—
	Moisture Seal	✓	✓	✓	✓
	Narrow Body	✓	✓	—	—
	Coil Transient Suppression Diodes and Polarity Protection Diode	✓	✓	✓	✓
Sub-D Connector	✓	✓	✓	✓	
		See Page 38	See Page 39	See Page 40	See Page 41



Series (Commercial)		CCP-47N	CCP-47D	CCP-38S	CCP-18N
Configuration		Transfer Switch	Transfer Switch	SP3T to SP6T	SP3T to SP6T
Switch Function		Latching	Latching	Normally Open	Normally Open
Frequency	Commercial Model	DC to 3 GHz	DC to 3 GHz	DC to 3 GHz	DC to 3 GHz
Coil Voltages Available		12, 15, 24, 28	12, 15, 24, 28	12, 15, 24, 28	12, 15, 24, 28
Connectors Available		N	7/16 DIN	SMA	N
Temperature Range	Commercial Model	-25°C to +65°C	-25°C to +65°C	-25°C to +65°C	-25°C to +65°C
Typical Contact Life Switch with Indicator Contacts		1,000,000 cycles 1,000,000 cycles	1,000,000 cycles 1,000,000 cycles	1,000,000 cycles 1,000,000 cycles	1,000,000 cycles 1,000,000 cycles
Passive Intermodulation Characteristics	3rd Order Intermodulation	1900 MHz -159.2 dBc Peak PIM	1900 MHz -165.5 dBc Peak PIM	1900 MHz -144.1 dBc Peak PIM	1900 MHz -146.7 dBc Peak PIM
	Tone 1 Frequency	1945 MHz @ 43 dBm	1945 MHz @ 43 dBm	1945 MHz @ 43 dBm	1945 MHz @ 43 dBm
	Tone 2 Frequency	1990 MHz @ 43 dBm	1990 MHz @ 43 dBm	1990 MHz @ 43 dBm	1990 MHz @ 43 dBm
Options	Self Cutoff (Latching Only)	✓	✓	—	—
	Indicator Contacts	✓	✓	✓	✓
	Self Cutoff and Indicator Contacts (Latching Only)	✓	✓	—	—
	TTL Interface	✓	✓	✓	✓
	TTL Decoder	—	—	✓	✓
	Moisture Seal	✓	✓	✓	✓
	Narrow Body	—	—	—	—
	Coil Transient Suppression Diodes and Polarity Protection Diode	✓	✓	✓	✓
	Sub-D Connector	✓	✓	✓	✓
	See Page 42	See Page 43	See Page 44	See Page 45	

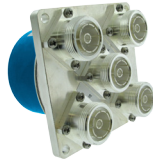

Series (Commercial)		CCP-18D
Configuration		SP3T to SP4T
Switch Function		Normally Open
Frequency	Commercial Model	DC to 3 GHz
Coil Voltages Available		12, 15, 24, 28
Connectors Available		7/16 DIN
Temperature Range	Commercial Model	-25°C to +65°C
Typical Contact Life		1,000,000 cycles
Switch with Indicator Contacts		1,000,000 cycles
Passive Intermodulation Characteristics	3rd Order Intermodulation	1900 MHz -156.6 dBc Peak PIM
	Tone 1 Frequency	1945 MHz @ 43 dBm
	Tone 2 Frequency	1990 MHz @ 43 dBm
Options	Self Cutoff (Latching Only)	—
	Indicator Contacts	✓
	Self Cutoff and Indicator Contacts (Latching Only)	—
	TTL Interface	✓
	TTL Decoder	✓
	Moisture Seal	✓
	Narrow Body	—
	Coil Transient Suppression Diodes and Polarity Protection Diode	✓
	Sub-D Connector	✓
		See Page 46

PART NUMBER SYSTEM

This guide shows the model numbers for switches by Teledyne Coax Switches. For technical support or custom switches for specific applications, call (800) 351-7368.

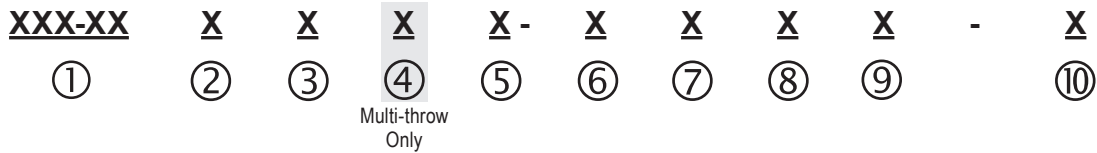

Example: CCR-33S10-T (Commercial SPDT, S=SMA, 28 Vdc, Failsafe, TTL)

All standard switches are RoHS compliant. Contact factory for other options.

①	Switch Model Series Type and Description									
	See tables on pages 2–7 for series name.									
②	Connector Type									
	<table style="width: 100%; border-collapse: collapse;"> <tr> <td style="width: 33%;">D 7/16 DIN Female</td> <td style="width: 33%;">N N Female</td> <td style="width: 33%;">HN High Power Type N Female</td> </tr> <tr> <td>K 2.92 mm Female</td> <td>S SMA Female</td> <td>HT High Power TNC Female</td> </tr> <tr> <td>M Mini SMB</td> <td>T TNC Female</td> <td>F 75Ω F Female***</td> </tr> </table>	D 7/16 DIN Female	N N Female	HN High Power Type N Female	K 2.92 mm Female	S SMA Female	HT High Power TNC Female	M Mini SMB	T TNC Female	F 75Ω F Female***
D 7/16 DIN Female	N N Female	HN High Power Type N Female								
K 2.92 mm Female	S SMA Female	HT High Power TNC Female								
M Mini SMB	T TNC Female	F 75Ω F Female***								
③	Actuator Voltage									
	<table style="width: 100%; border-collapse: collapse;"> <tr> <td style="width: 50%;">1 28 Vdc – Failsafe (Normally Open if single-pole multi-throw)</td> <td style="width: 50%;">6 28 Vdc – Latching*</td> </tr> <tr> <td>2 15 Vdc – Failsafe (Normally Open if single-pole multi-throw)</td> <td>7 15 Vdc – Latching*</td> </tr> <tr> <td>3 12 Vdc – Failsafe (Normally Open if single-pole multi-throw)</td> <td>8 12 Vdc – Latching*</td> </tr> <tr> <td>4 24 Vdc – Failsafe (Normally Open if single-pole multi-throw)</td> <td>9 24 Vdc – Latching*</td> </tr> </table>	1 28 Vdc – Failsafe (Normally Open if single-pole multi-throw)	6 28 Vdc – Latching*	2 15 Vdc – Failsafe (Normally Open if single-pole multi-throw)	7 15 Vdc – Latching*	3 12 Vdc – Failsafe (Normally Open if single-pole multi-throw)	8 12 Vdc – Latching*	4 24 Vdc – Failsafe (Normally Open if single-pole multi-throw)	9 24 Vdc – Latching*	
1 28 Vdc – Failsafe (Normally Open if single-pole multi-throw)	6 28 Vdc – Latching*									
2 15 Vdc – Failsafe (Normally Open if single-pole multi-throw)	7 15 Vdc – Latching*									
3 12 Vdc – Failsafe (Normally Open if single-pole multi-throw)	8 12 Vdc – Latching*									
4 24 Vdc – Failsafe (Normally Open if single-pole multi-throw)	9 24 Vdc – Latching*									
④	Number Positions for Multi-throw									
	3, 4, 5, 6, 7, 8, 9, 0=10 Indicates number of positions on multi-throw switches (skip this number if not single-pole multi-throw)									
⑤	Actuator Type									
	<table style="width: 100%; border-collapse: collapse;"> <tr> <td style="width: 50%;">0 No self-cutoff or indicator contacts</td> <td style="width: 50%;">D Self cutoff only</td> </tr> <tr> <td>C Indicator contacts only</td> <td>E Self cutoff and indicator contacts</td> </tr> </table>	0 No self-cutoff or indicator contacts	D Self cutoff only	C Indicator contacts only	E Self cutoff and indicator contacts					
0 No self-cutoff or indicator contacts	D Self cutoff only									
C Indicator contacts only	E Self cutoff and indicator contacts									
⑥	TTL Driver									
	<table style="width: 100%; border-collapse: collapse;"> <tr> <td style="width: 50%;">T TTL driver with diodes</td> <td style="width: 50%;">TD Decoders and TTL driver with diodes**</td> </tr> </table>	T TTL driver with diodes	TD Decoders and TTL driver with diodes**							
T TTL driver with diodes	TD Decoders and TTL driver with diodes**									
⑦	Polarity									
	R Positive (+) Common. Option not available with T and TD options.									
⑧	Narrow Body and/or Moisture Seal									
	<table style="width: 100%; border-collapse: collapse;"> <tr> <td style="width: 50%;">N Narrow Body (SPDT switch only)</td> <td style="width: 50%;">M Moisture Seal</td> </tr> </table>	N Narrow Body (SPDT switch only)	M Moisture Seal							
N Narrow Body (SPDT switch only)	M Moisture Seal									
⑨	Coil Transient Suppression and/or Sub-D Connector									
	<table style="width: 100%; border-collapse: collapse;"> <tr> <td style="width: 50%;">D Coil Transient Suppression Diode & Polarity Protection Diode</td> <td style="width: 50%;">S Sub-D Connector</td> </tr> </table>	D Coil Transient Suppression Diode & Polarity Protection Diode	S Sub-D Connector							
D Coil Transient Suppression Diode & Polarity Protection Diode	S Sub-D Connector									
⑩	Custom Part Number									
	Assigned by Engineering									

*Polarity Sensitive
 **SPMT Switches only
 ***Consult Factory

Note: Normally Open terminated switches are polarity sensitive

Space-qualified and custom switches available. Please contact factory for more information.

CCR-40K

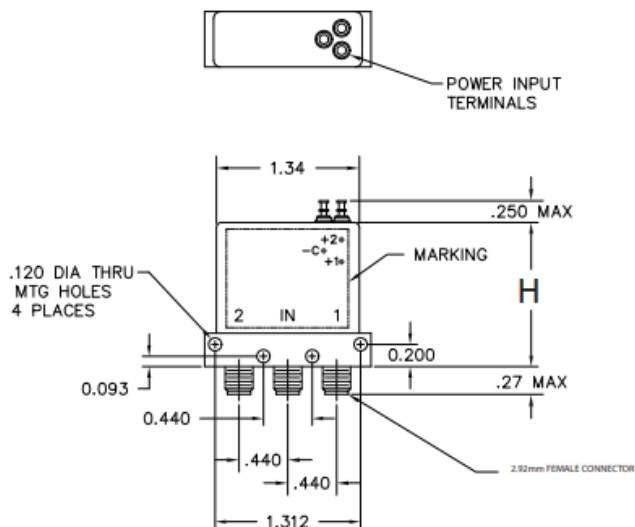
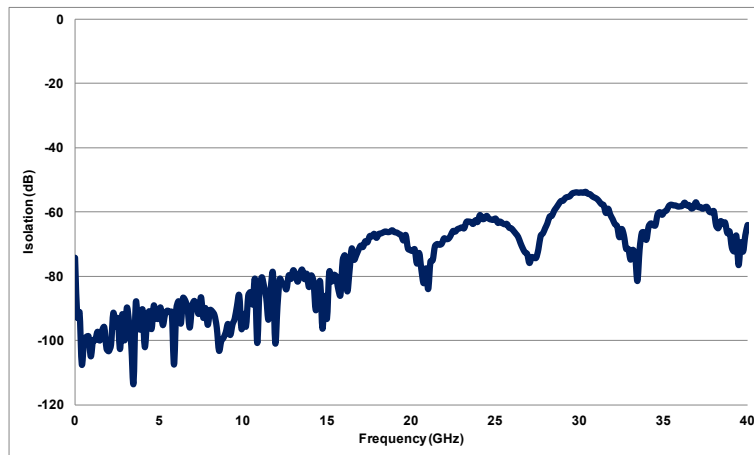
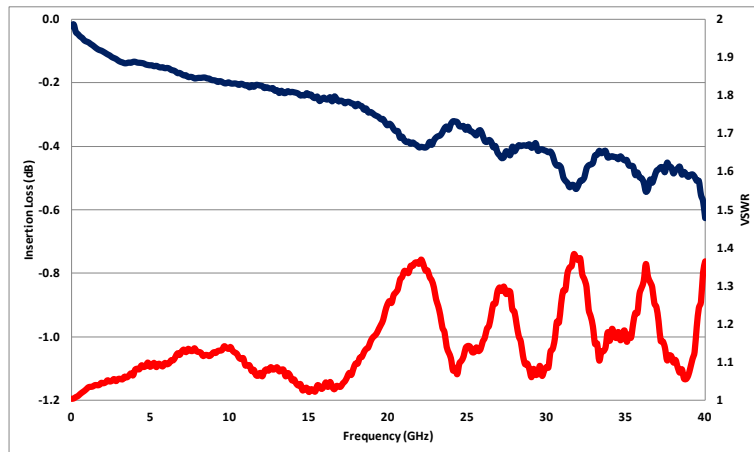

Standard Width Body

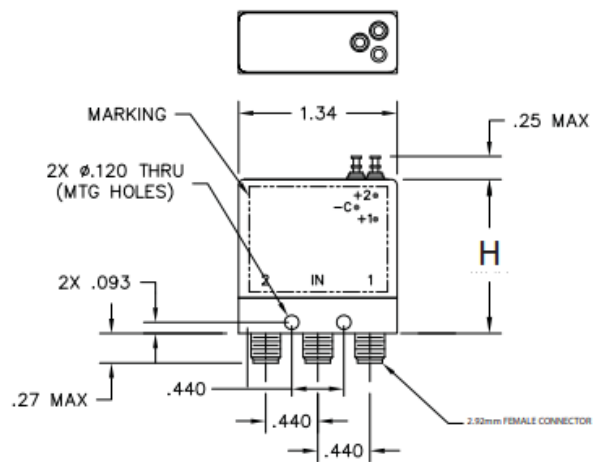

Optional Narrow Width Body

H = 1.45 MAX. STD MODEL
 H = 1.80 MAX. TTL MODEL OR SUB-D
 H = 2.20 MAX. TTL + SUB-D

CCR-33K/CR-33K

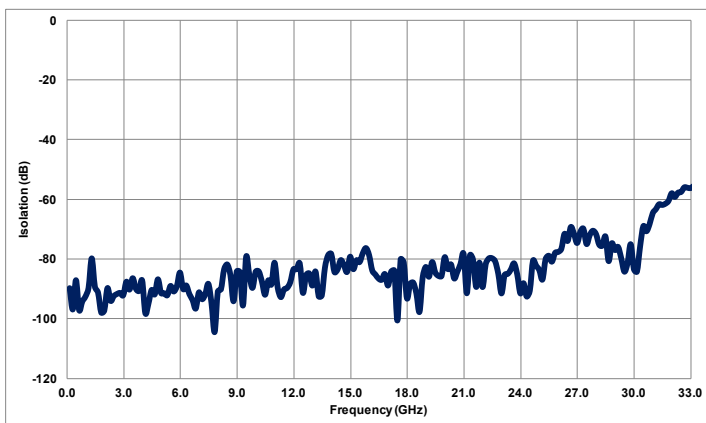
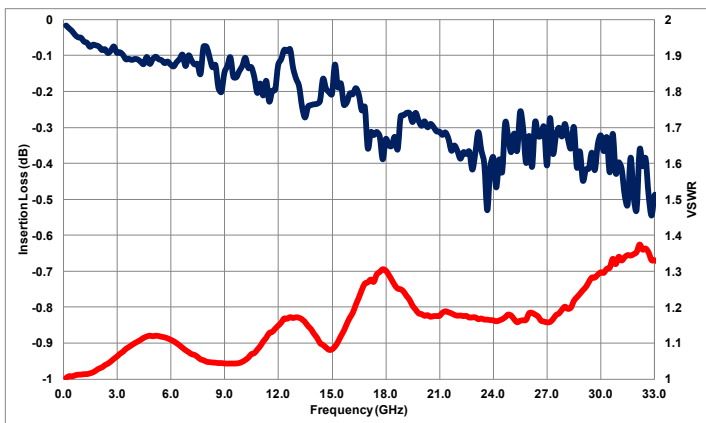

CCR-33S/CR-33S

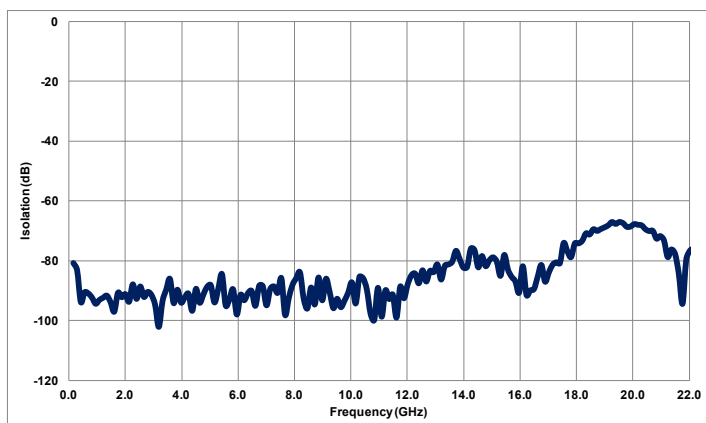
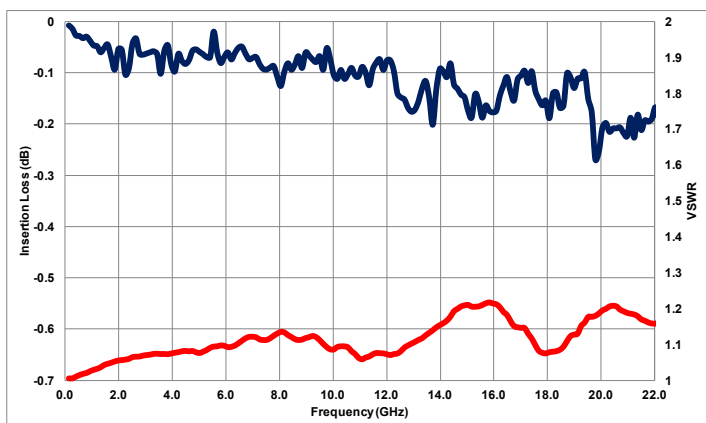

CCR-53/CR-53

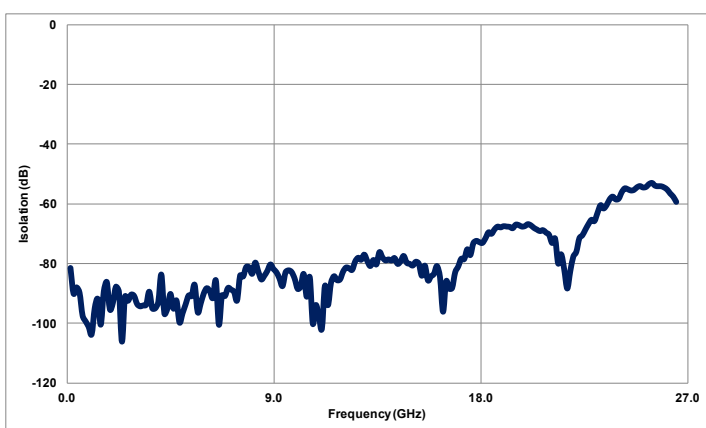
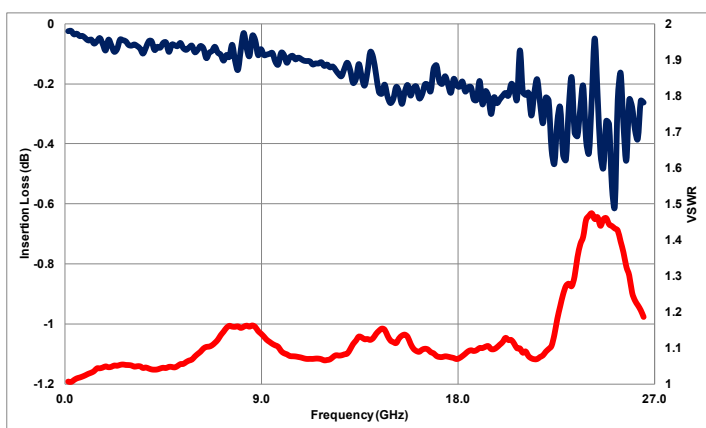

CCR-33K/CR-33K, CCR-33S/CR-33S, CCR-53S/CR-53S

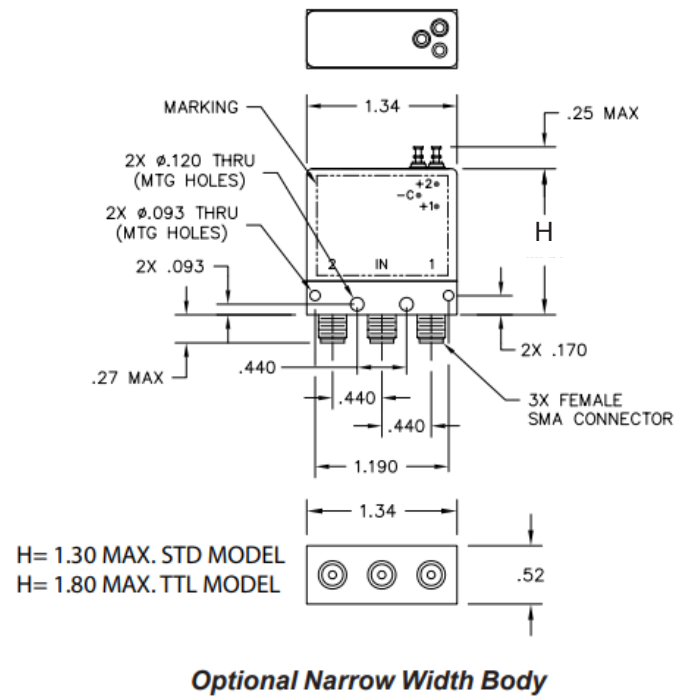
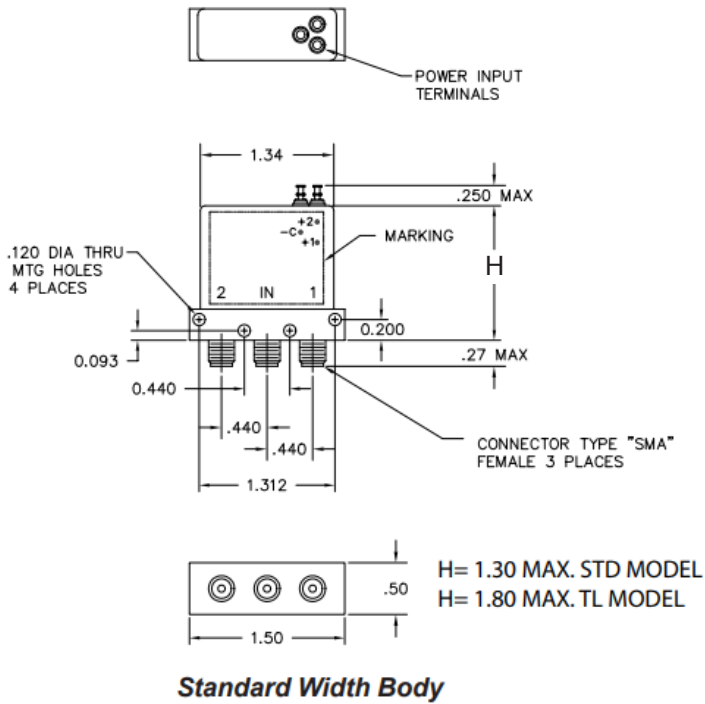

SPDT SWITCHES

CCRT-33/CRT-33

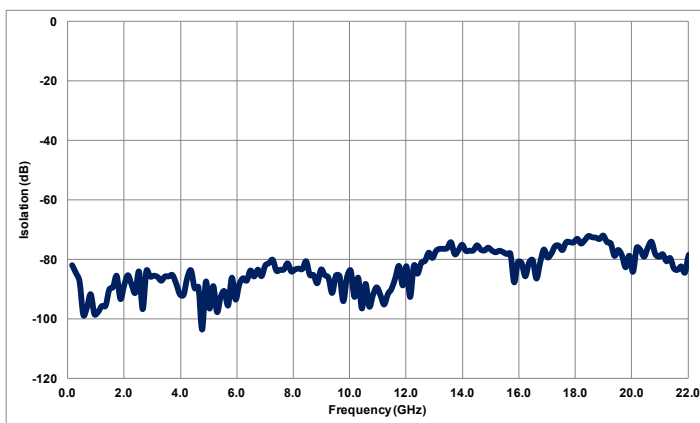
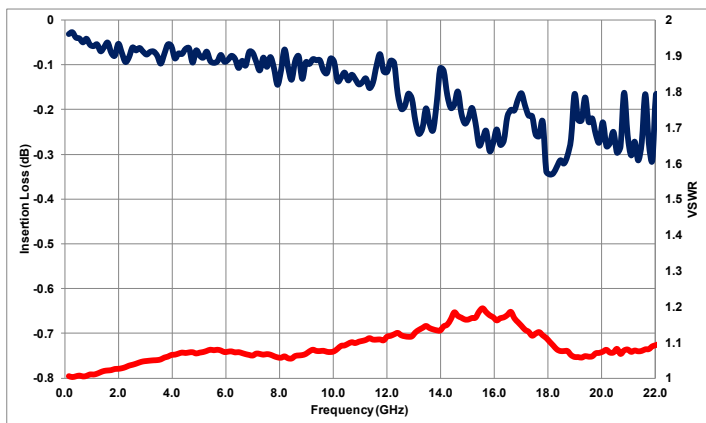

CCRT-53/CRT-53

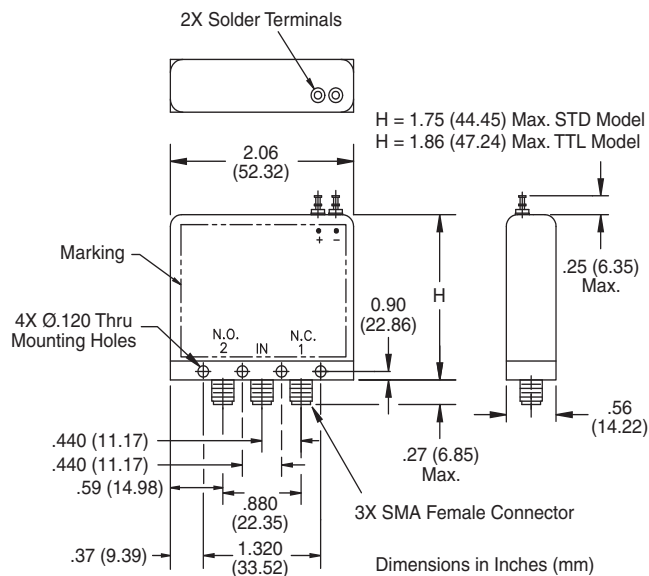
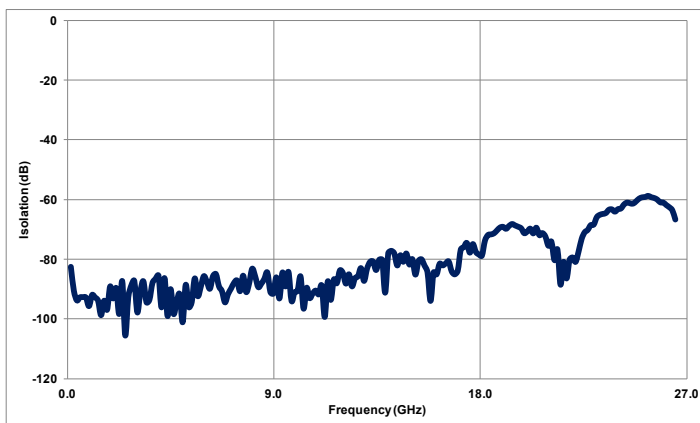
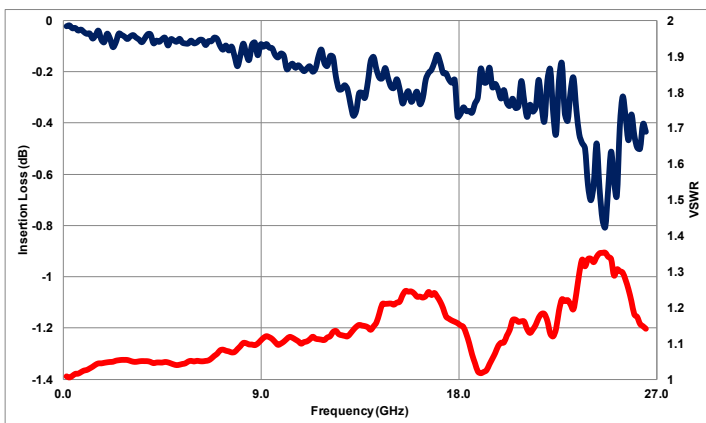

CCR-33M/CR-33M

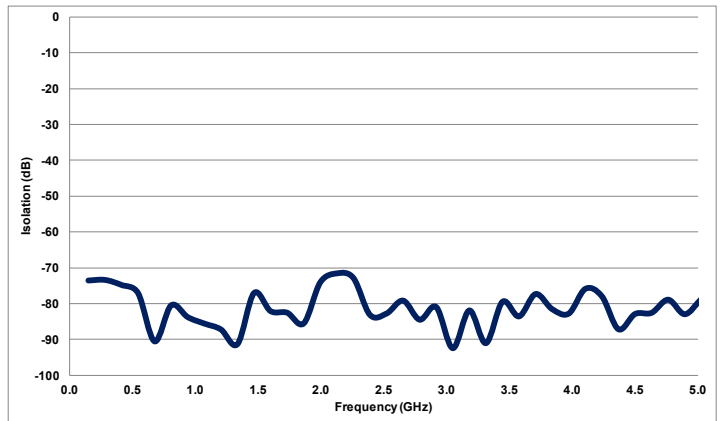
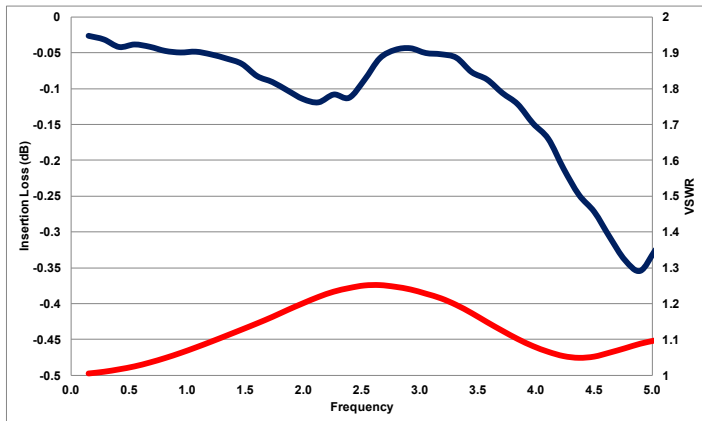

CCR-33M

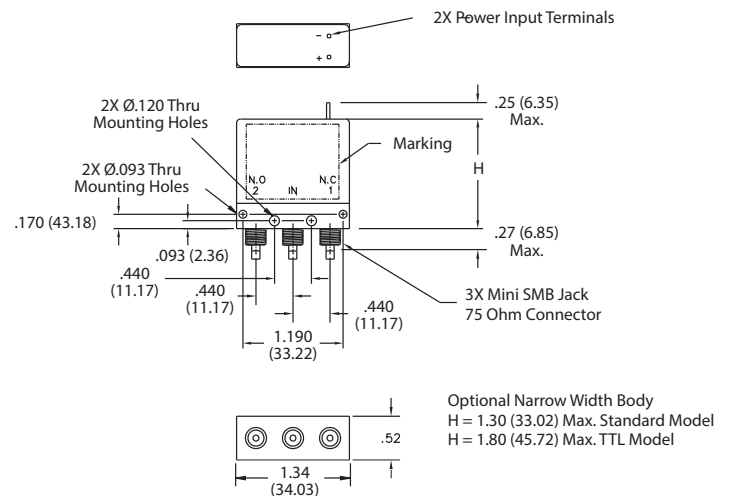
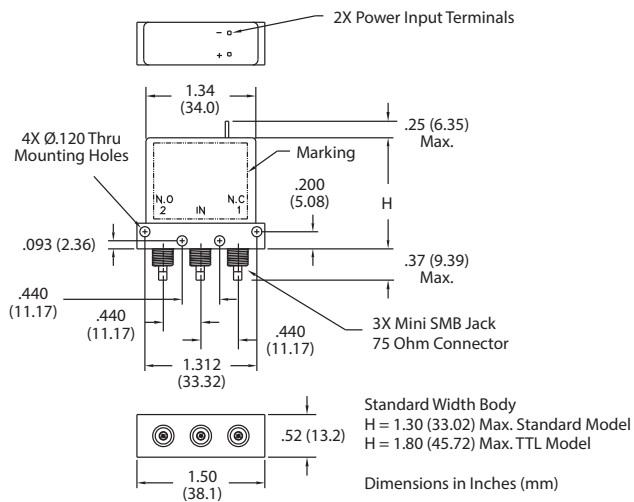

CCS-32/CS-32

SPDT SWITCHES

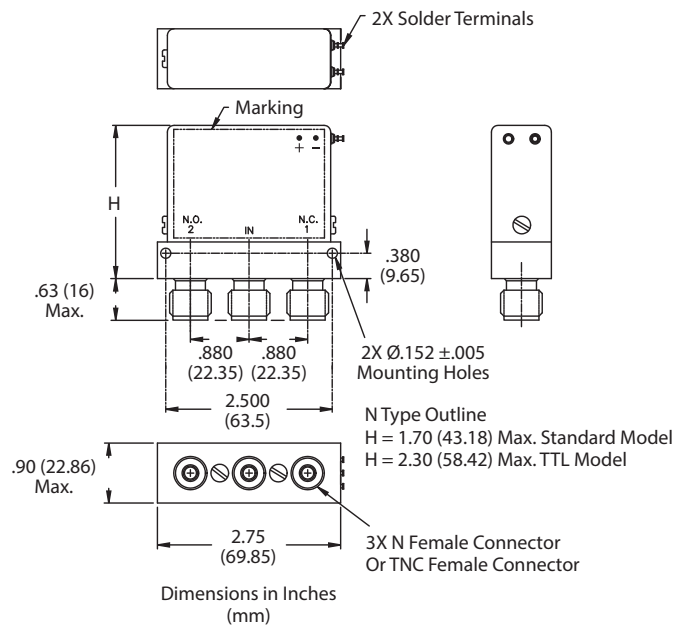
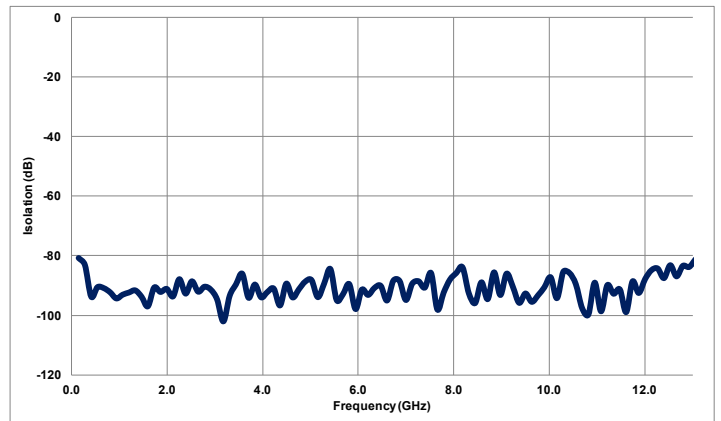
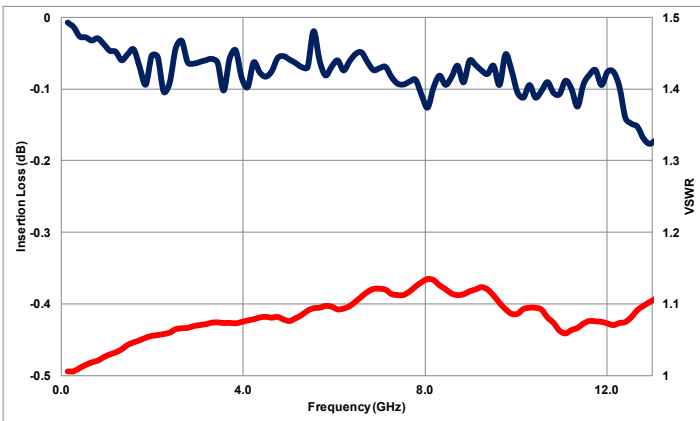

CCS-37K/CS-37K

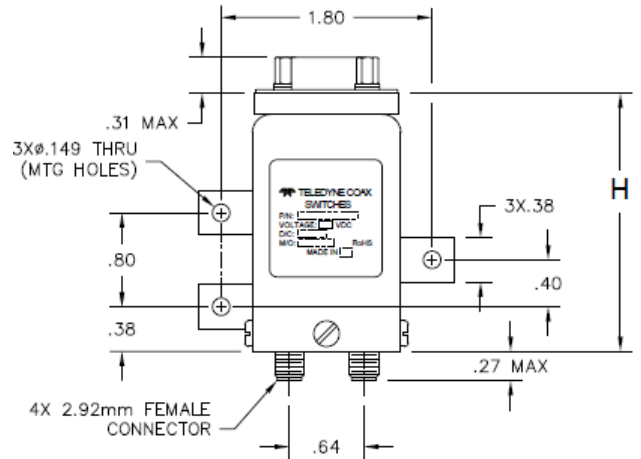
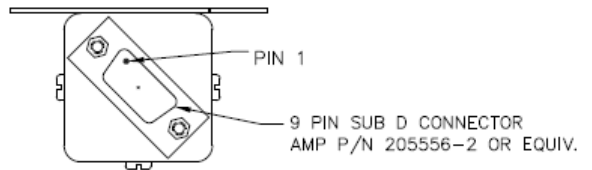
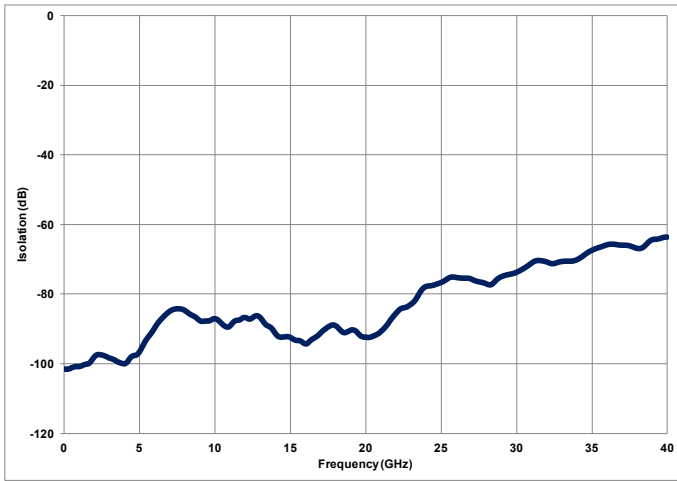
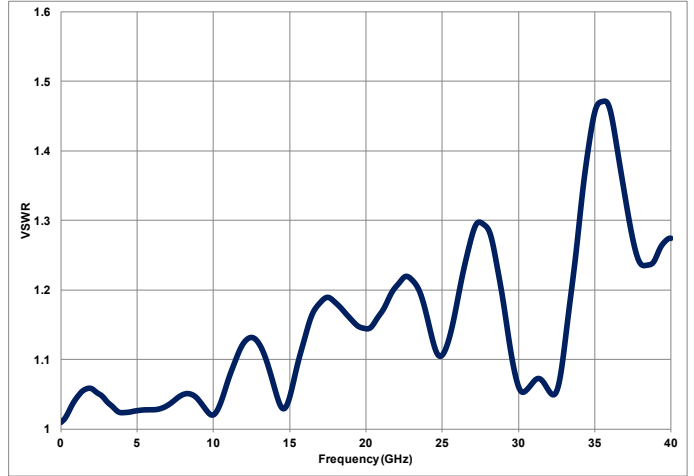
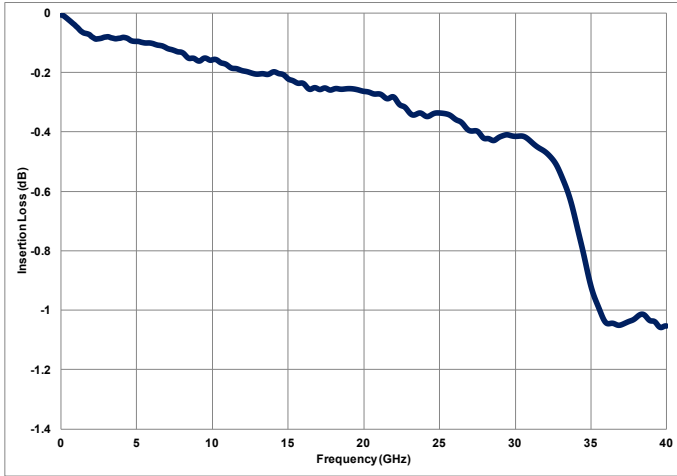

H= 2.00 Max. STD & Indicator Model
H= 2.10 Max. Self-Cutoff & TTL Model
H= 2.20 Max. 9-Pin D-Sub Model

CCS-37S/CS-37S

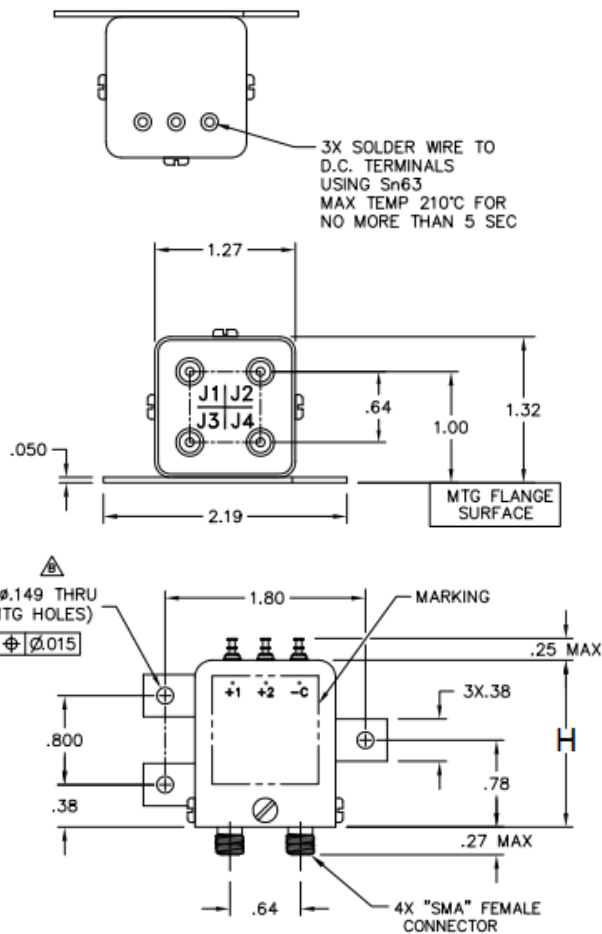
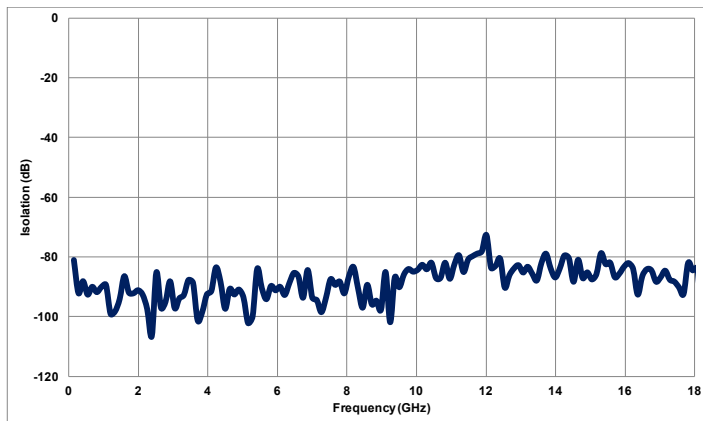
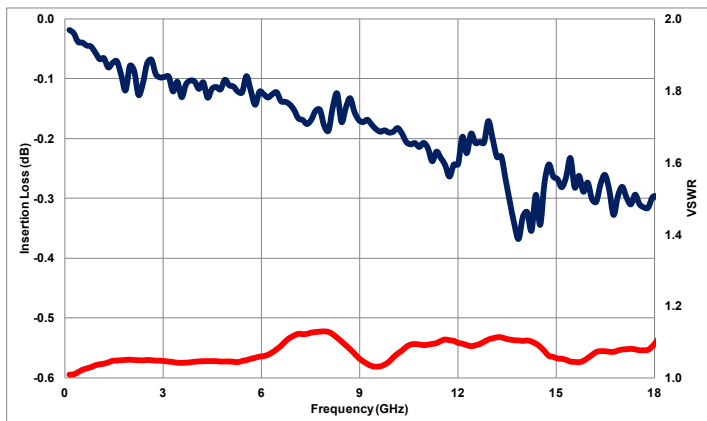

H= 1.50 Max. STD Model
 H= 1.75 Max. Indicator & Diode Model
 H= 2.00 Max 9-Pin D-Sub & TTL Model

TRANSFER/2P3T SWITCHES

CCRS-33/CRS-33

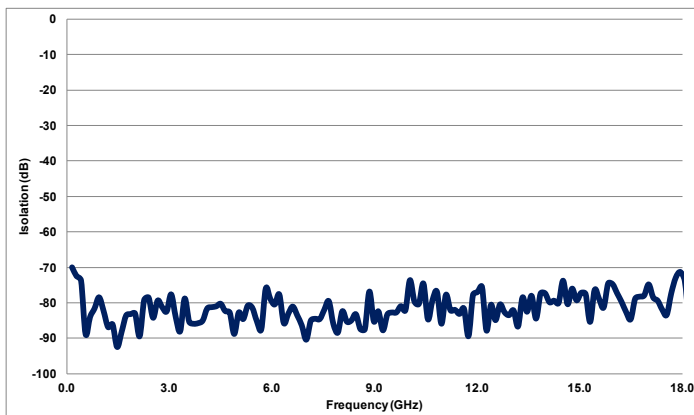
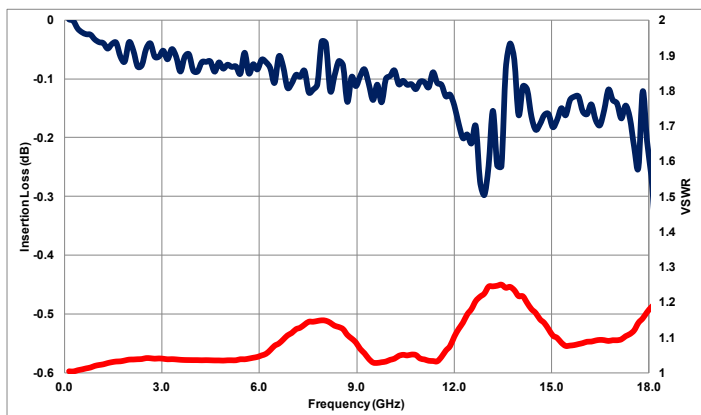

CCRS-53/CRS-53

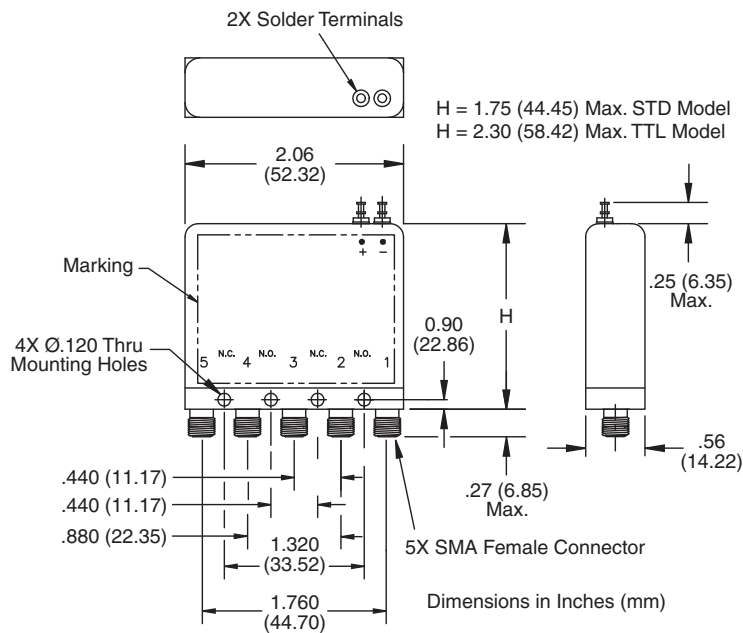
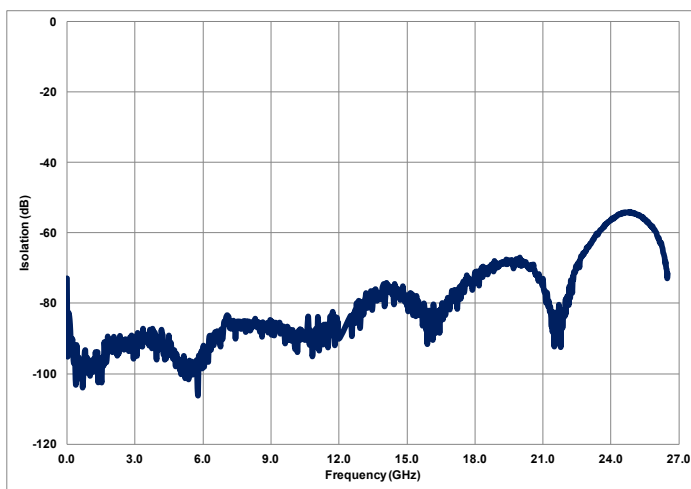
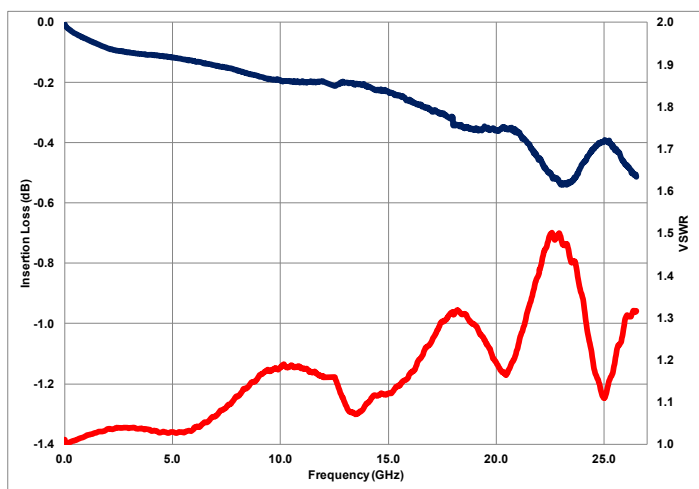

TRANSFER/2P3T SWITCHES

CCS-47/CS-47

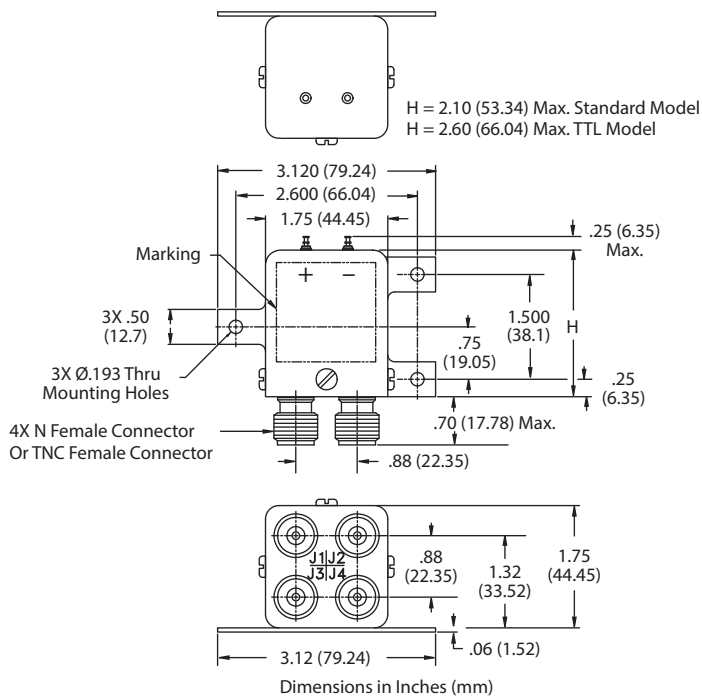
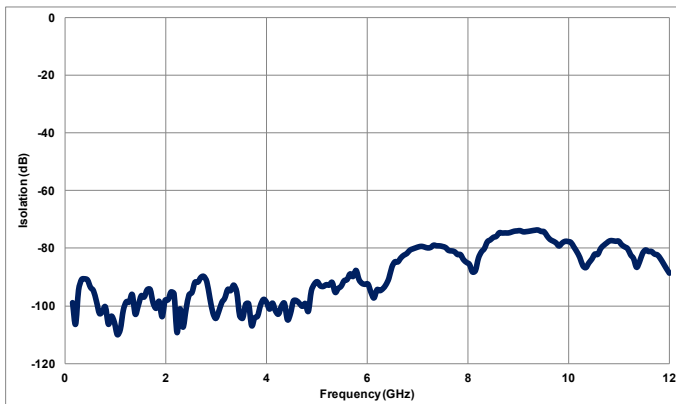
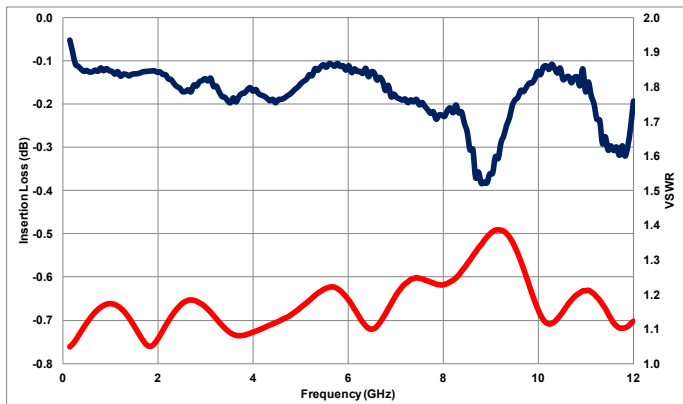

TRANSFER/2P3T SWITCHES

CCR-48K/CR-48K, CCT-48K/CT-48K

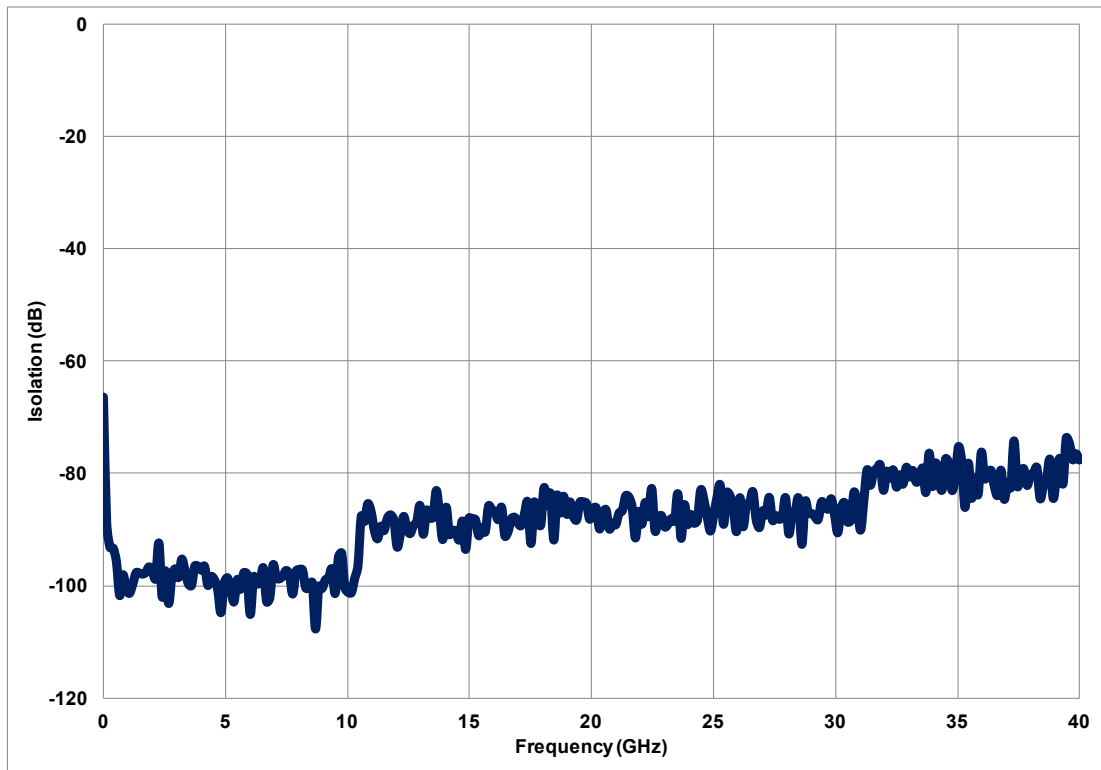
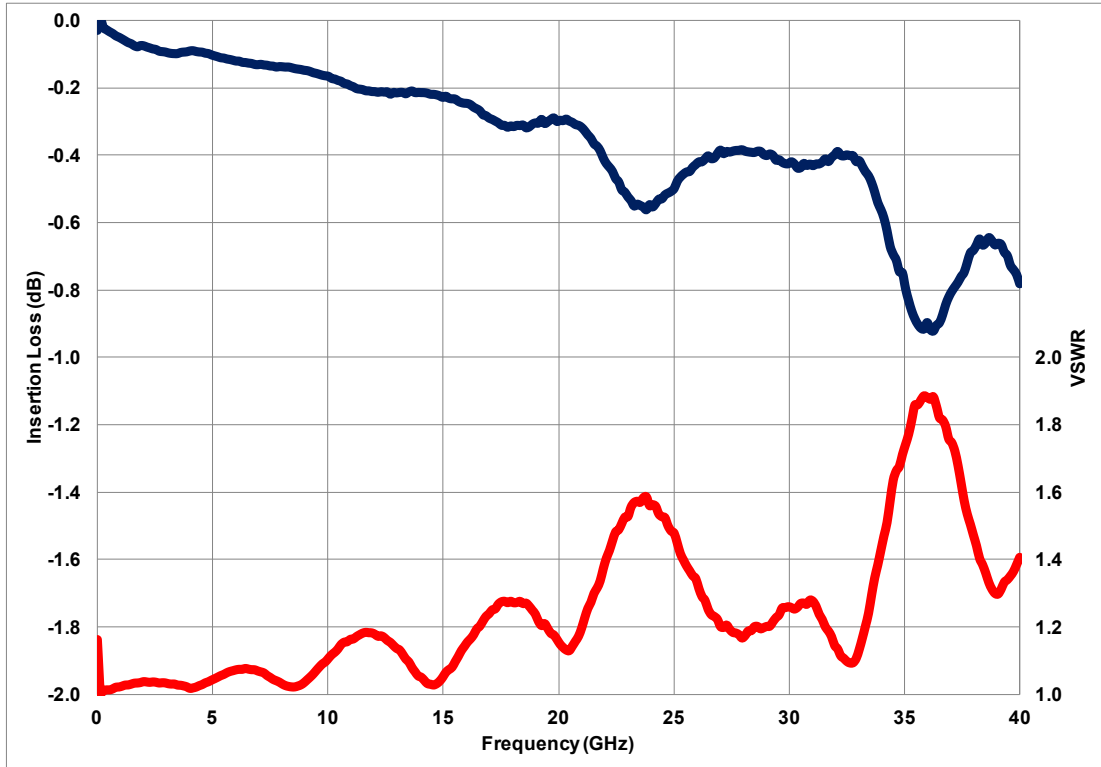

CCR-38S/CR-38S, CCT-38S/CT-38S (SP3T - SP6T)

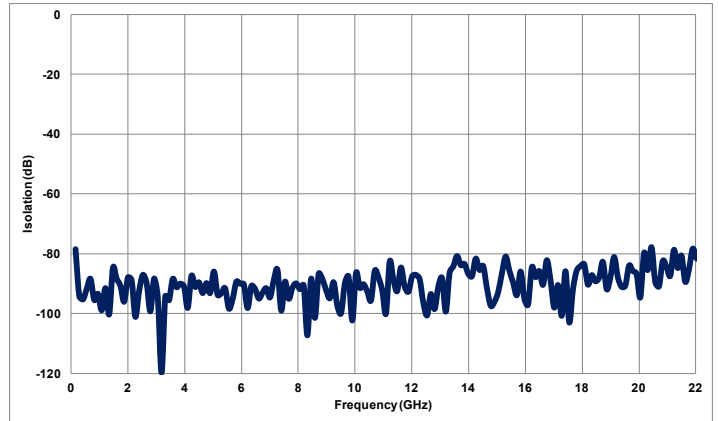
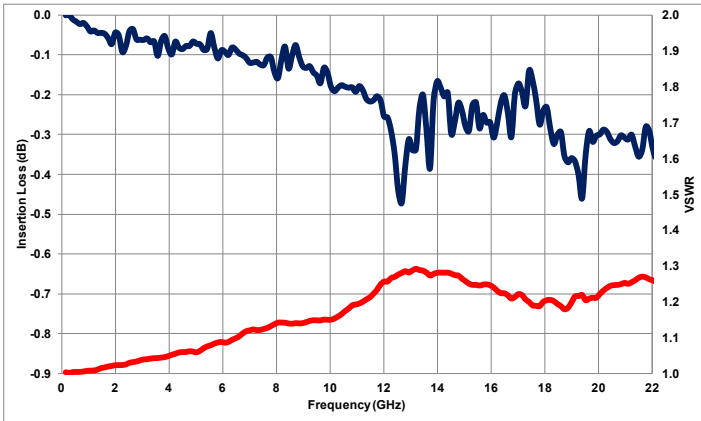

CCR-38S/CR-38S, CCT-38S/CT-38S (SP7T - SP8T)

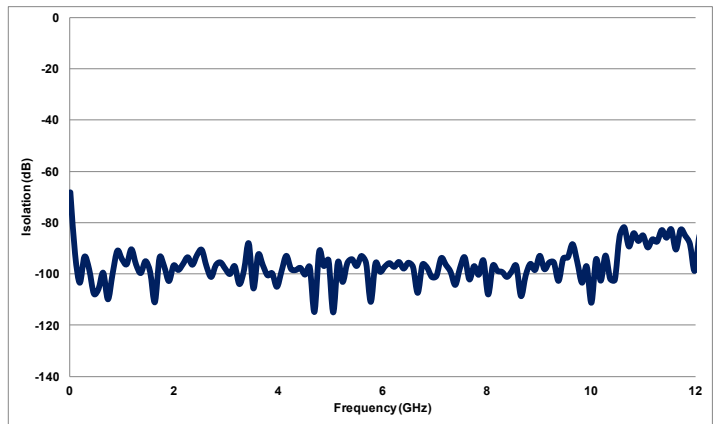
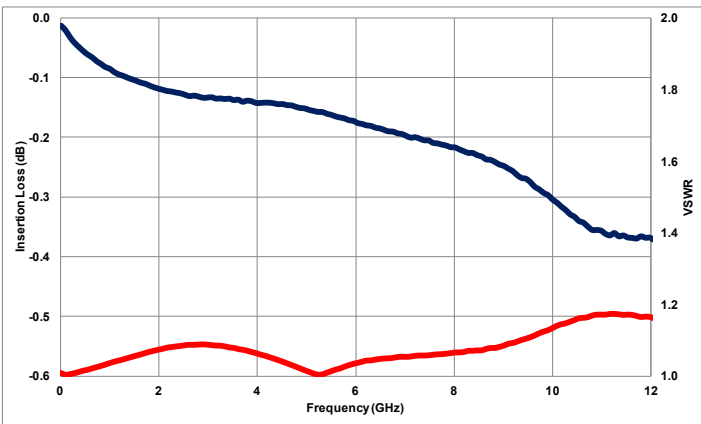

CCR-38S/CR-38S, CCT-38S/CT-38S (SP9T - SP10T)

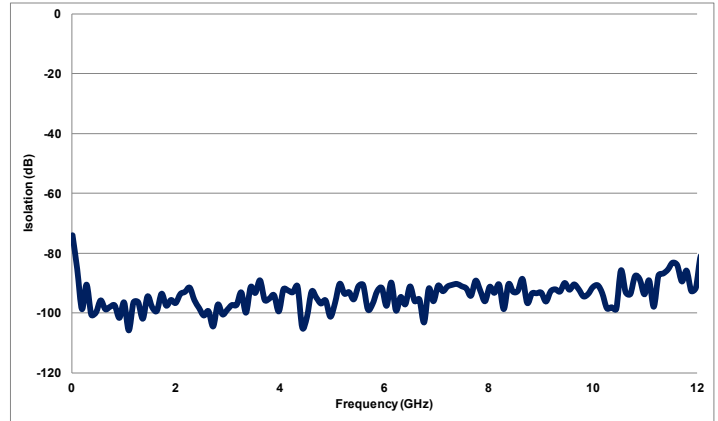
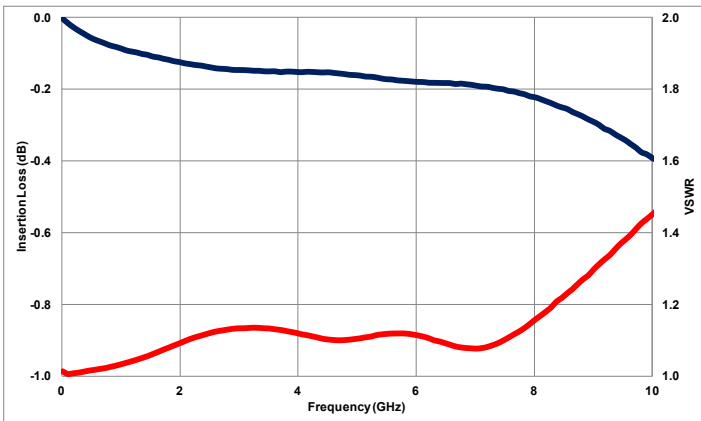

CCR-58S/CR-58S, CCT-58S/CT-58S (SP3T - SP6T)

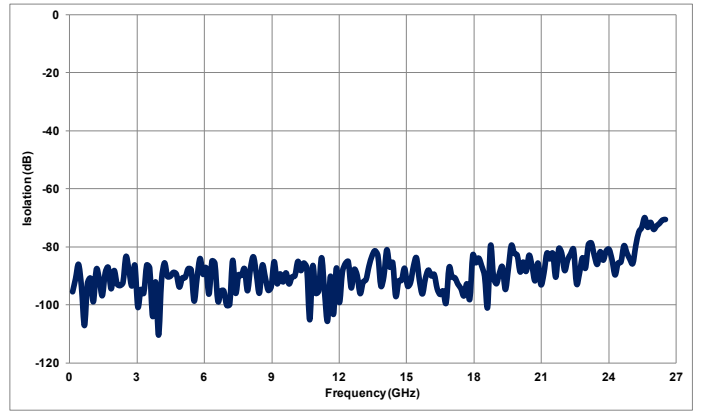
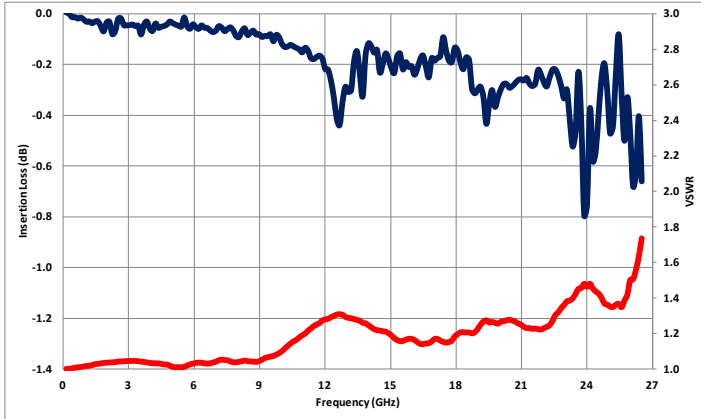

CCR-58S/CR-58S, CCT-58S/CT-58S (SP7T - SP8T)

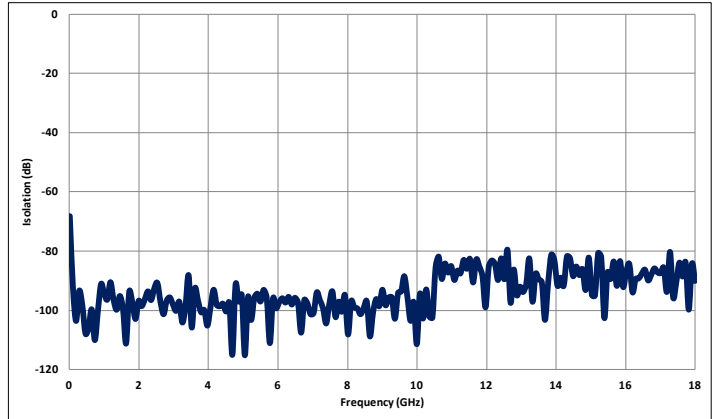
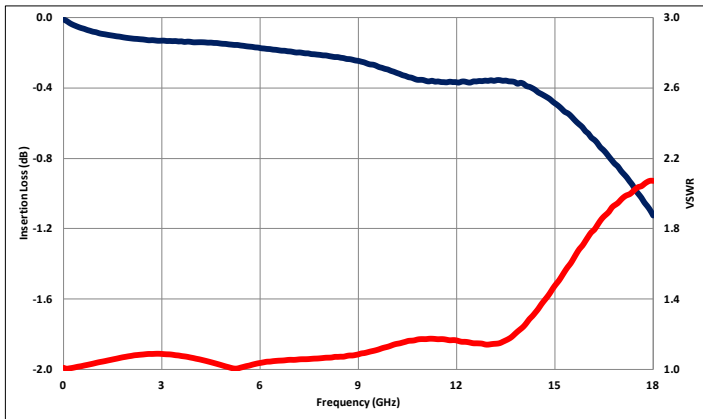

CCR-58S/CR-58S, CCT-58S/CT-58S (SP9T - SP10T)

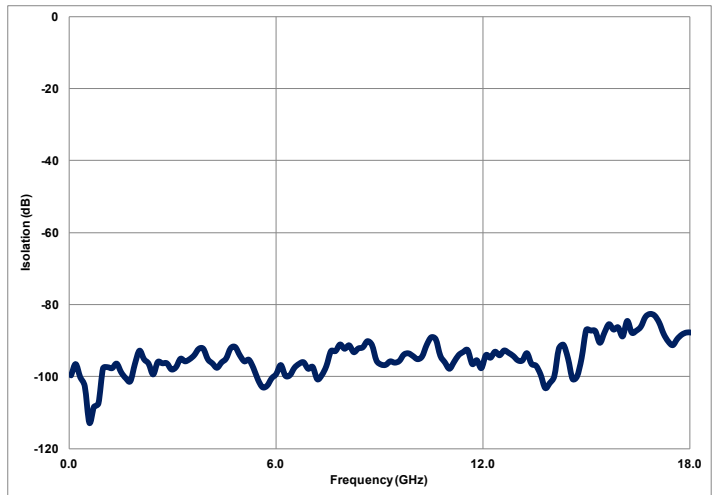
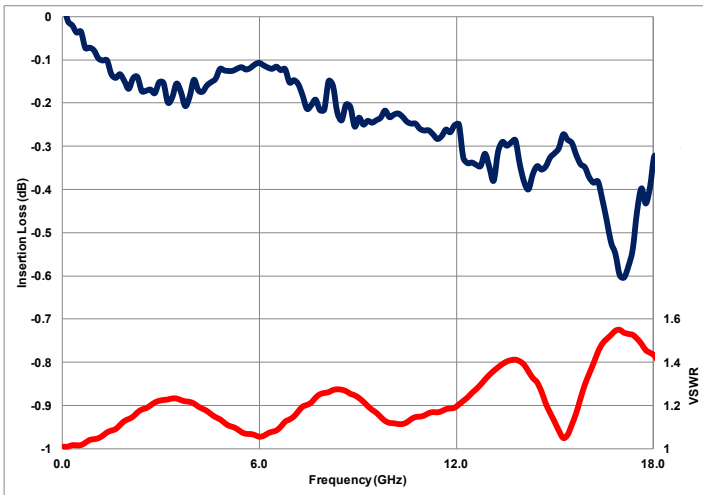

CCR-48K/CR-48K, CCR-38/CR-38, CCR-58/CR-58

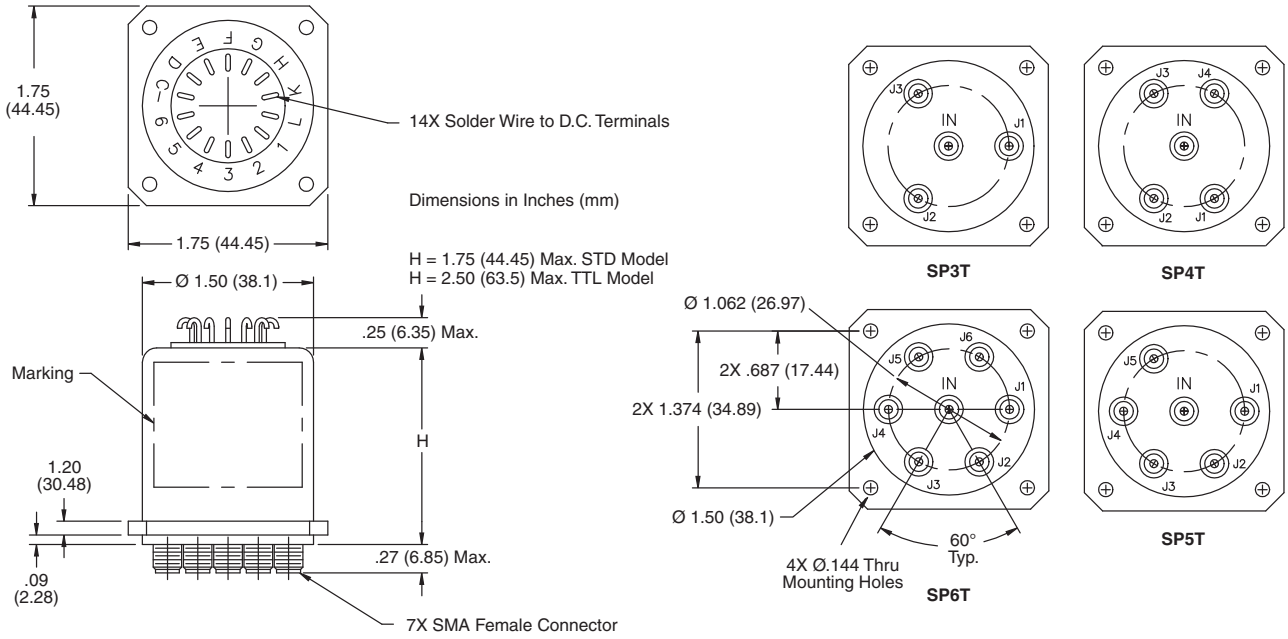

CCT-48K/CT-48K, CCT-38/CT-38, CCT-58/CT-58 (SP3T-SP6T)

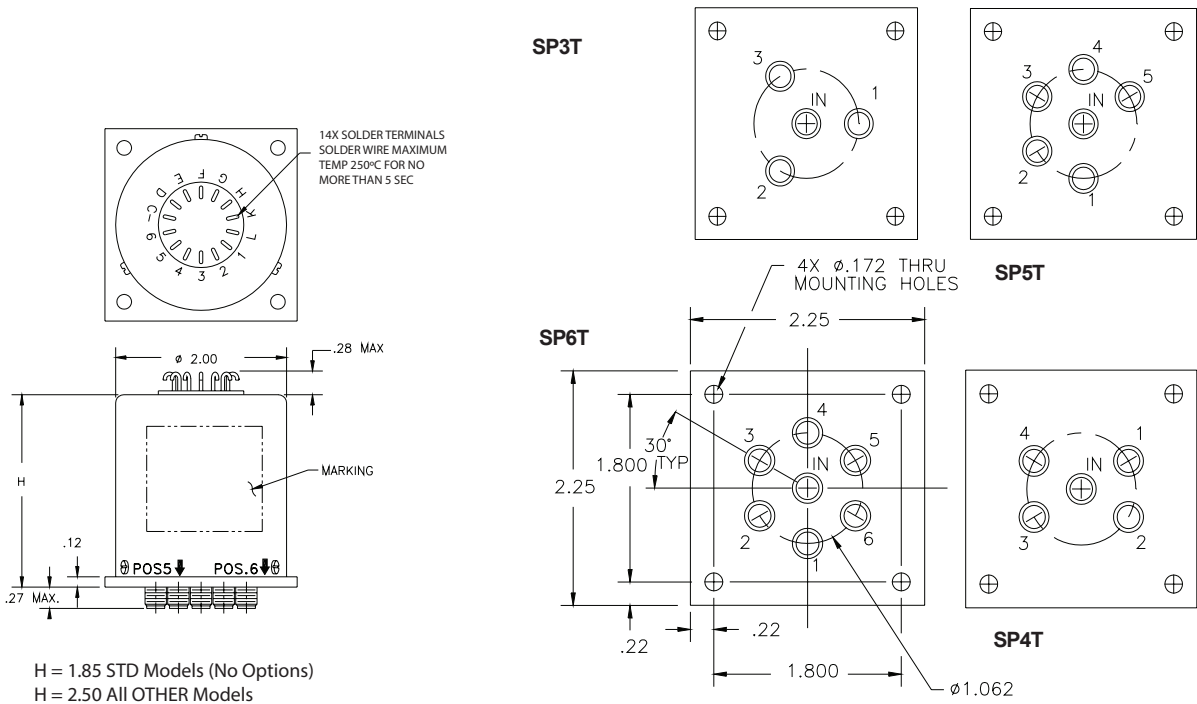

MULTI-THROW SWITCHES

CCR-38/CR-38, CCR-58/CR-58, CCT-38/CT-38, CCT-58/CT-58 (SP7T-SP10T)

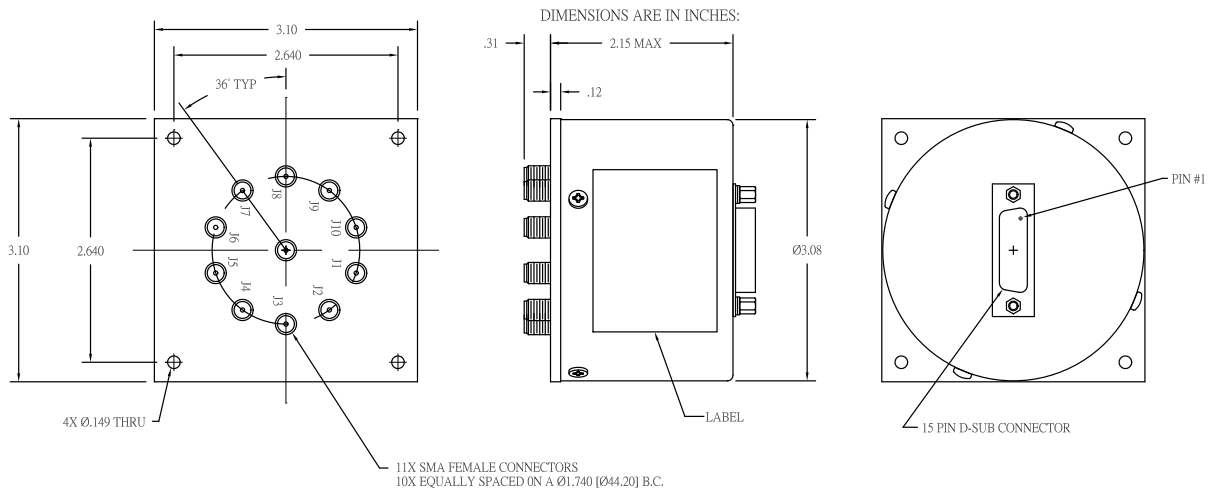
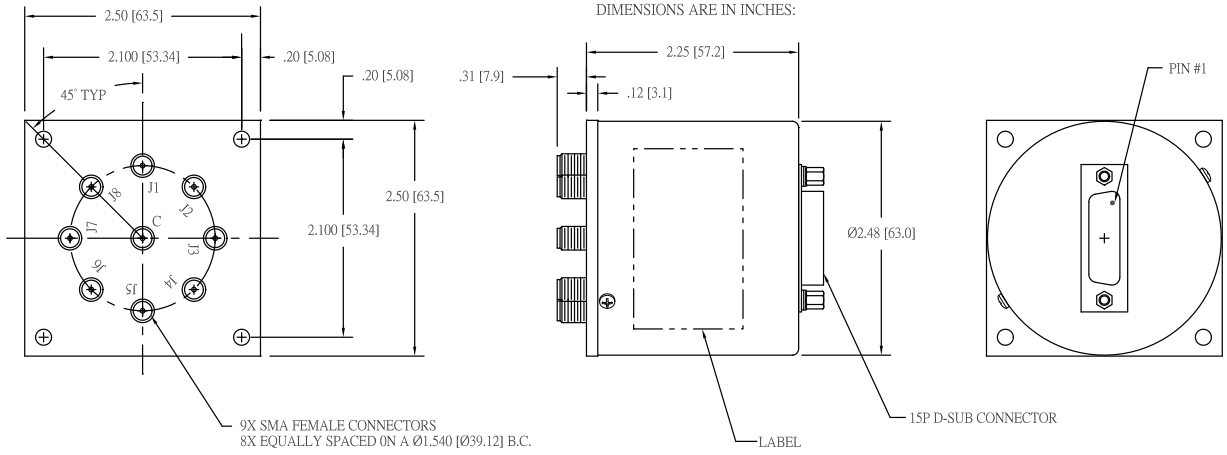

CCS-18/CS-18

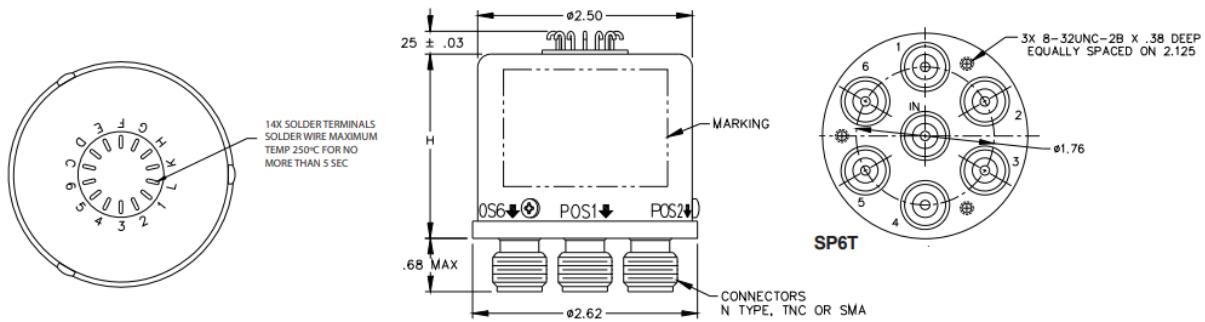
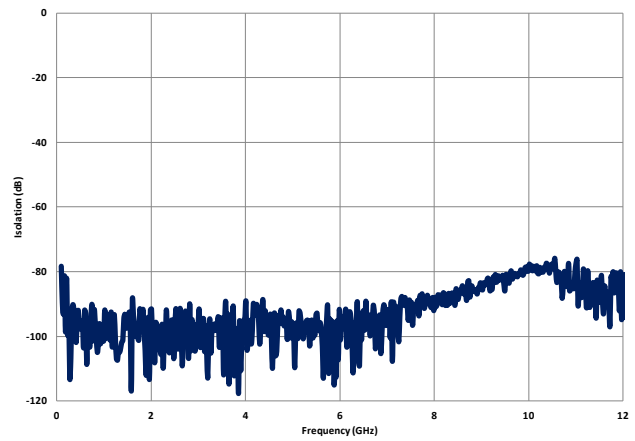
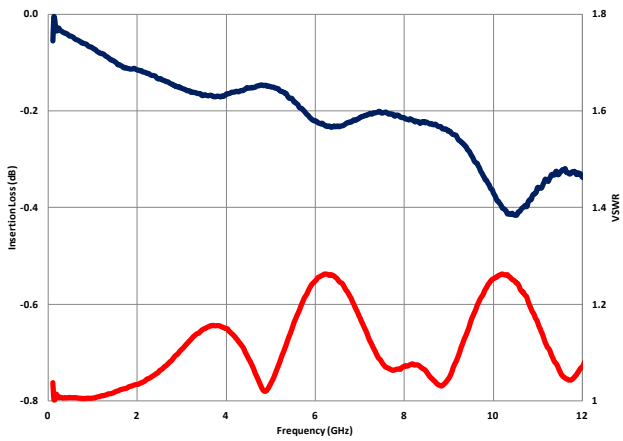

SP3T - SP6T H = 2.15 STD & Indicator Model
 SP3T - SP6T H = 2.65 ALL OTHER MODELS

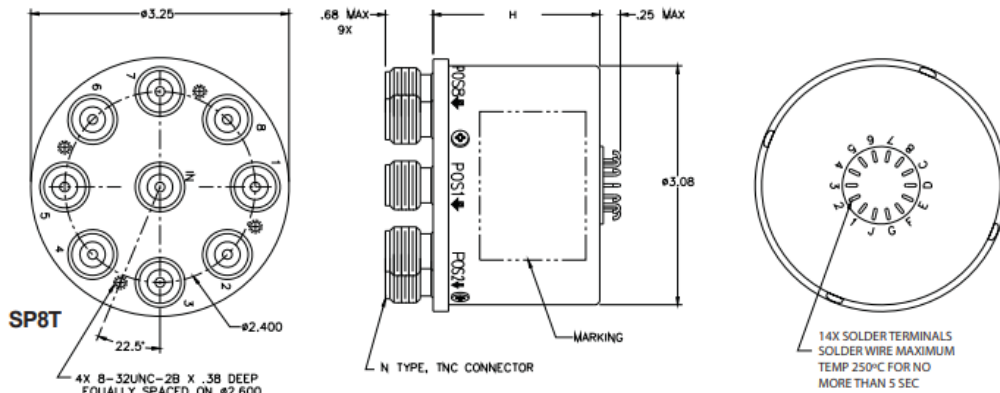

SP7T & SP8T H = 2.15 STD Model
 SP7T & SP8T H = 2.65 ALL OTHER MODELS

CCR-49K/CR-49K, CCT-49K/CT-49K

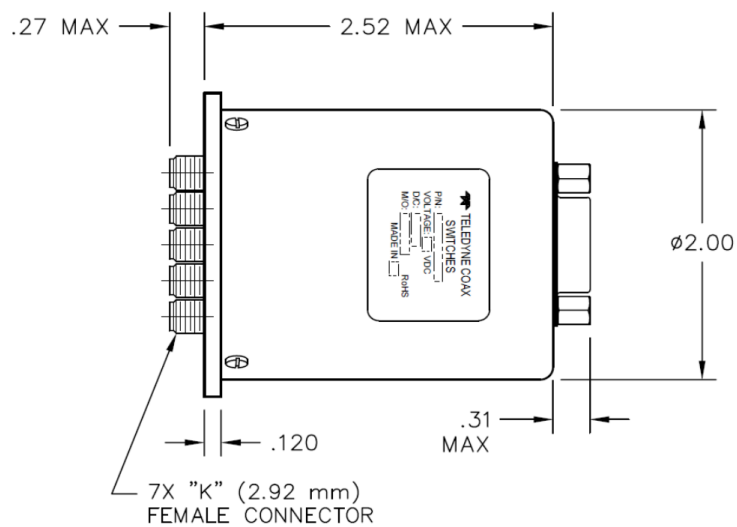
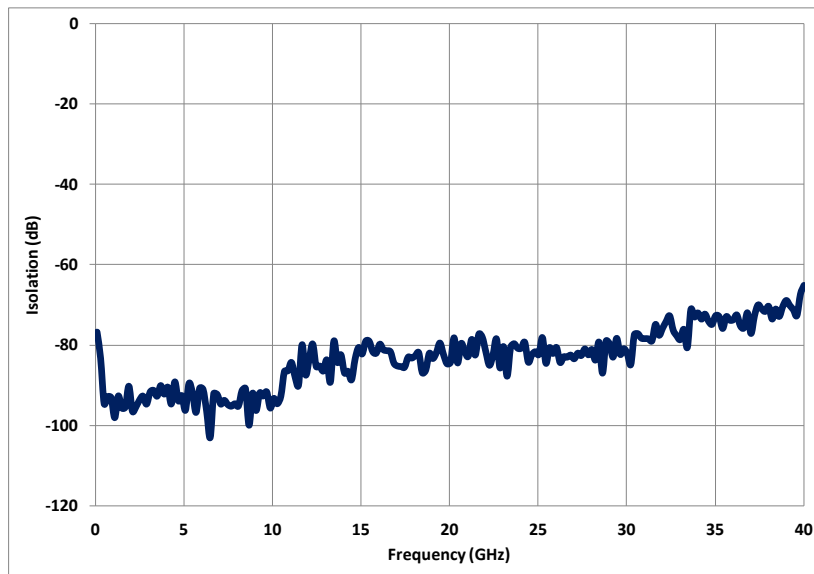
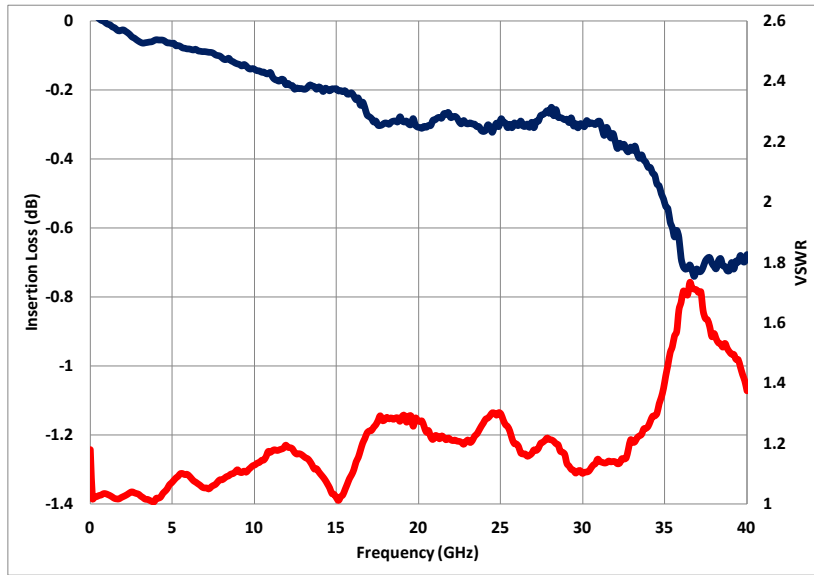

CCR-39/CR-39, CCT-39/CT-39 (SP3T-SP6T)

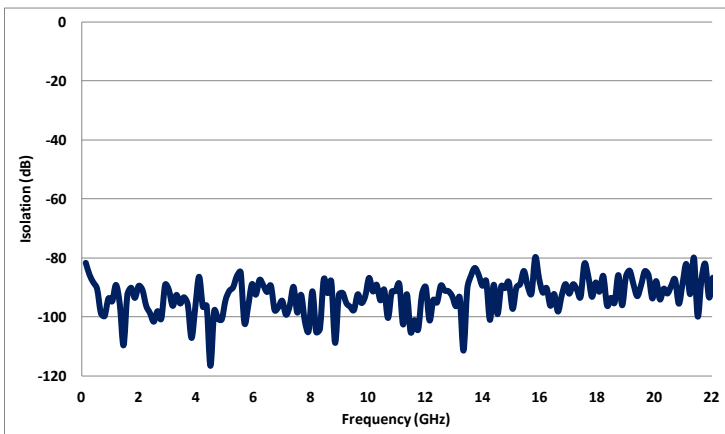
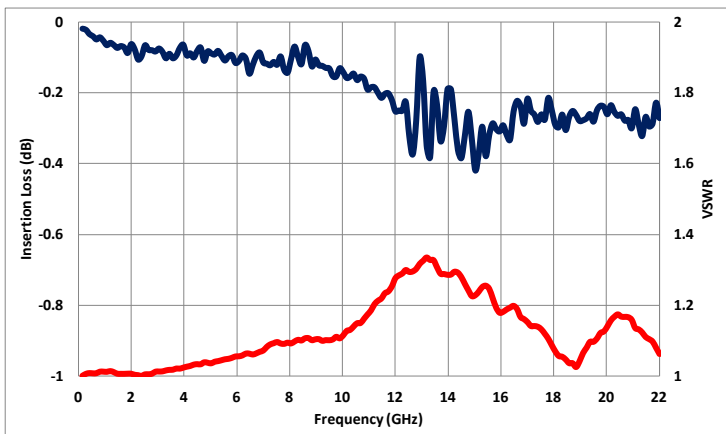

CCR-39/CR-39, CCT-39/CT-39 (SP7T-SP8T)

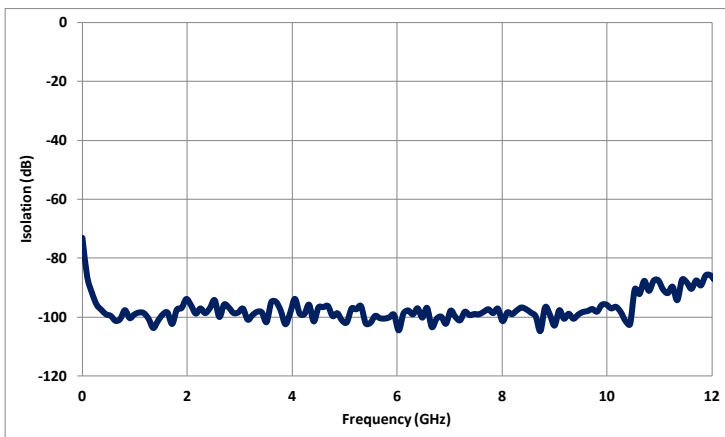
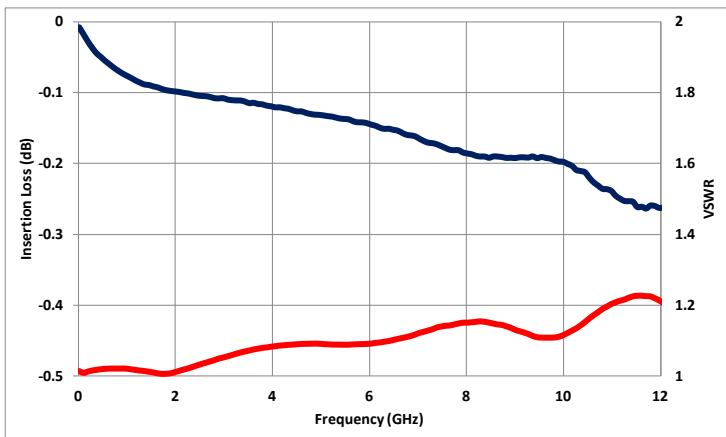

CCR-39/CR-39, CCT-39/CT-39 (SP9T-SP10T)

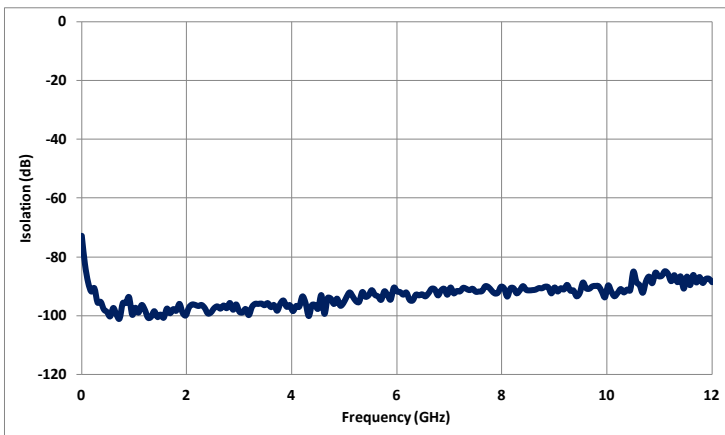
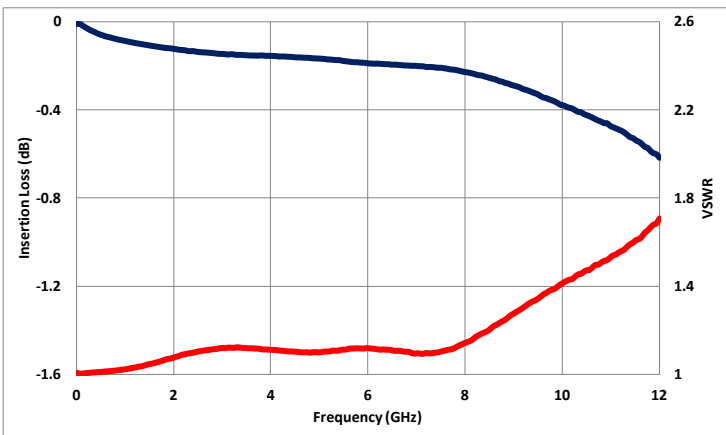

MULTI-THROW SWITCHES

CCR-59/CR-59, CCT-59/CT-59 (SP3T-SP6T)

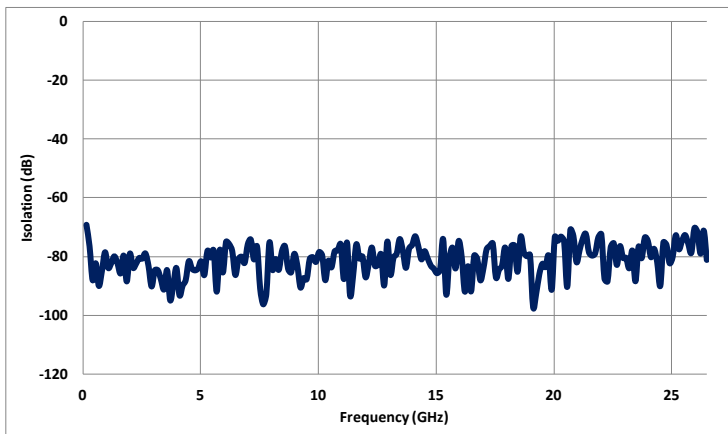
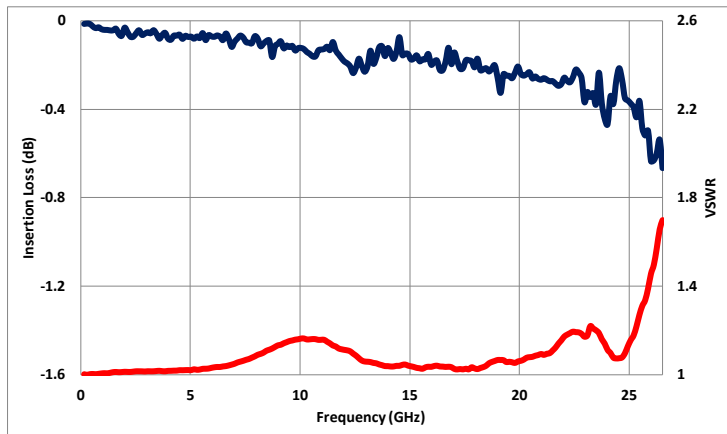

CCR-59/CR-59, CCT-59/CT-59 (SP7T-SP8T)

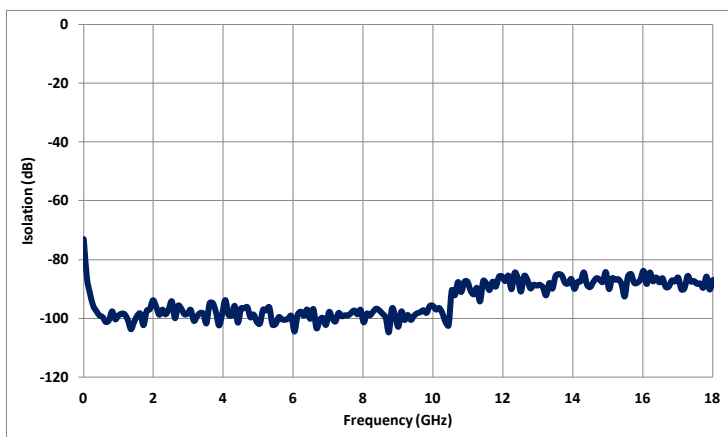
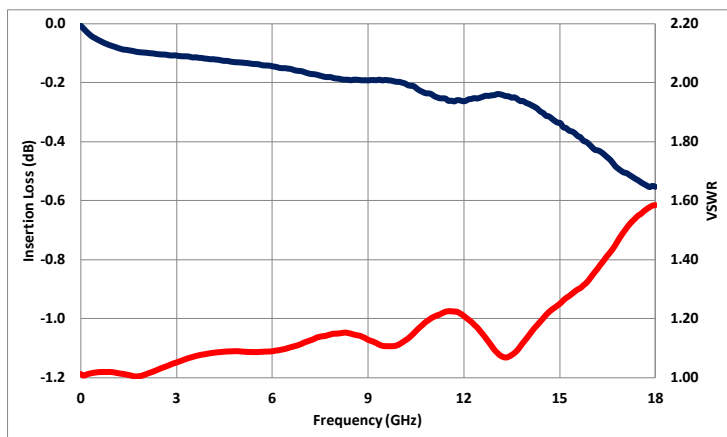

CCR-59/CR-59, CCT-59/CT-59 (SP9T-SP10T)

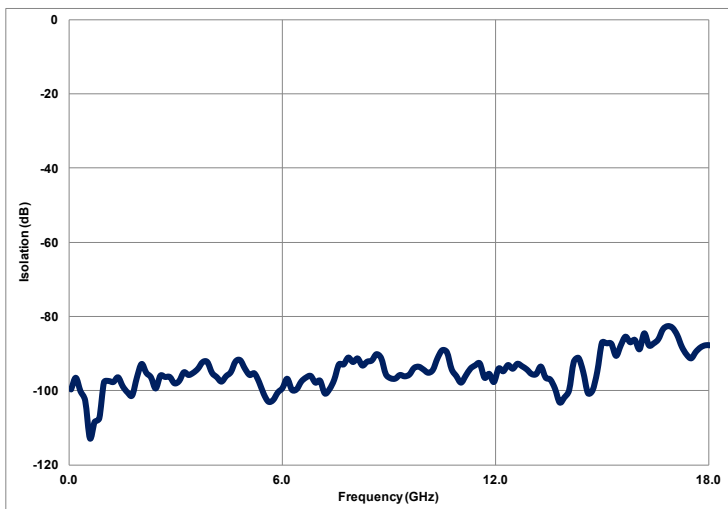
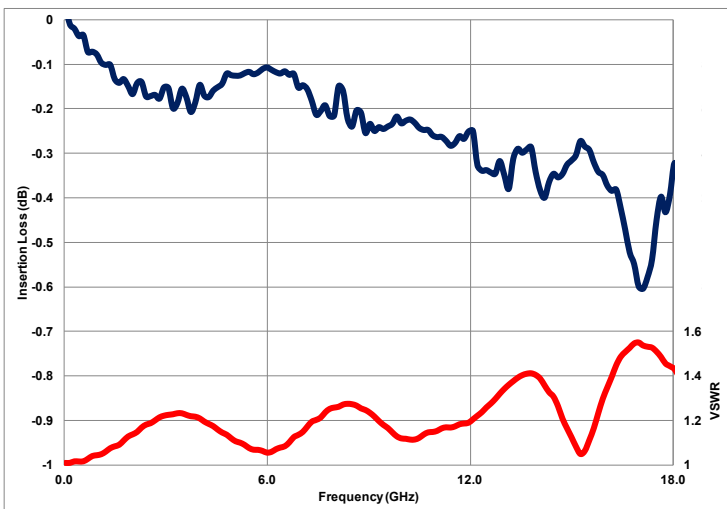

CCR-39/CR-39, CCR-59/CR-59, CCT-39/CT-39, CCT-59/CT-59 (SP3T-SP6T)

2.25 (57.15) Dimensions in Inches (mm)

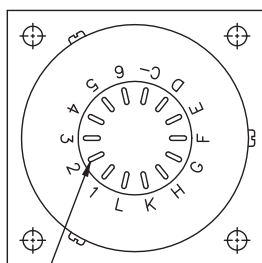

14X Solder Wire to D.C. Terminals

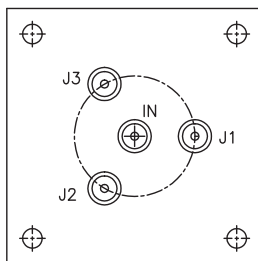

SP3T

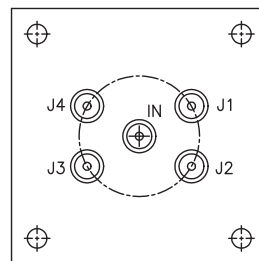

SP4T

H = 1.75 (44.45) Max. STD Model
H = 2.50 (63.5) Max. TTL Model

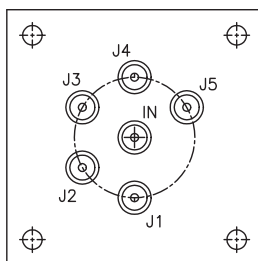
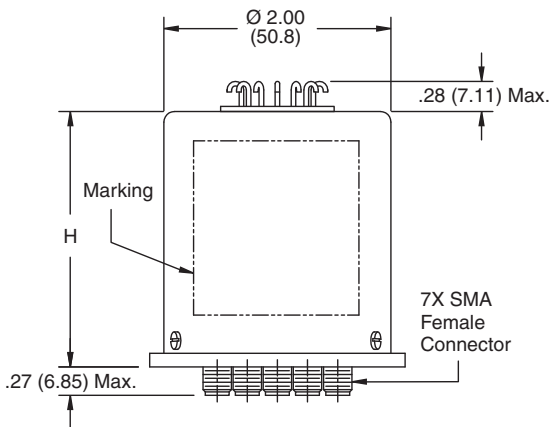

SP5T

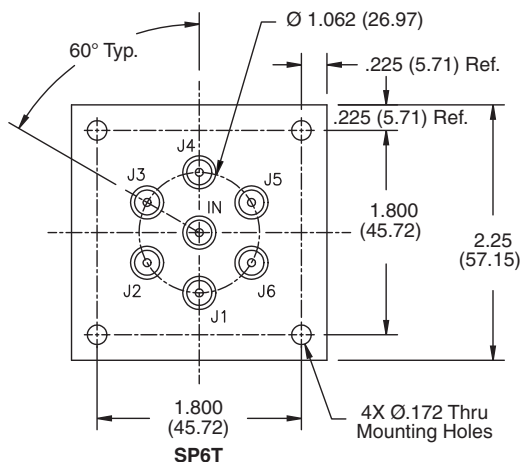

SP6T

CCR-39, CCR-59, CCT-39, CCT-59 (SP7T-SP10T)

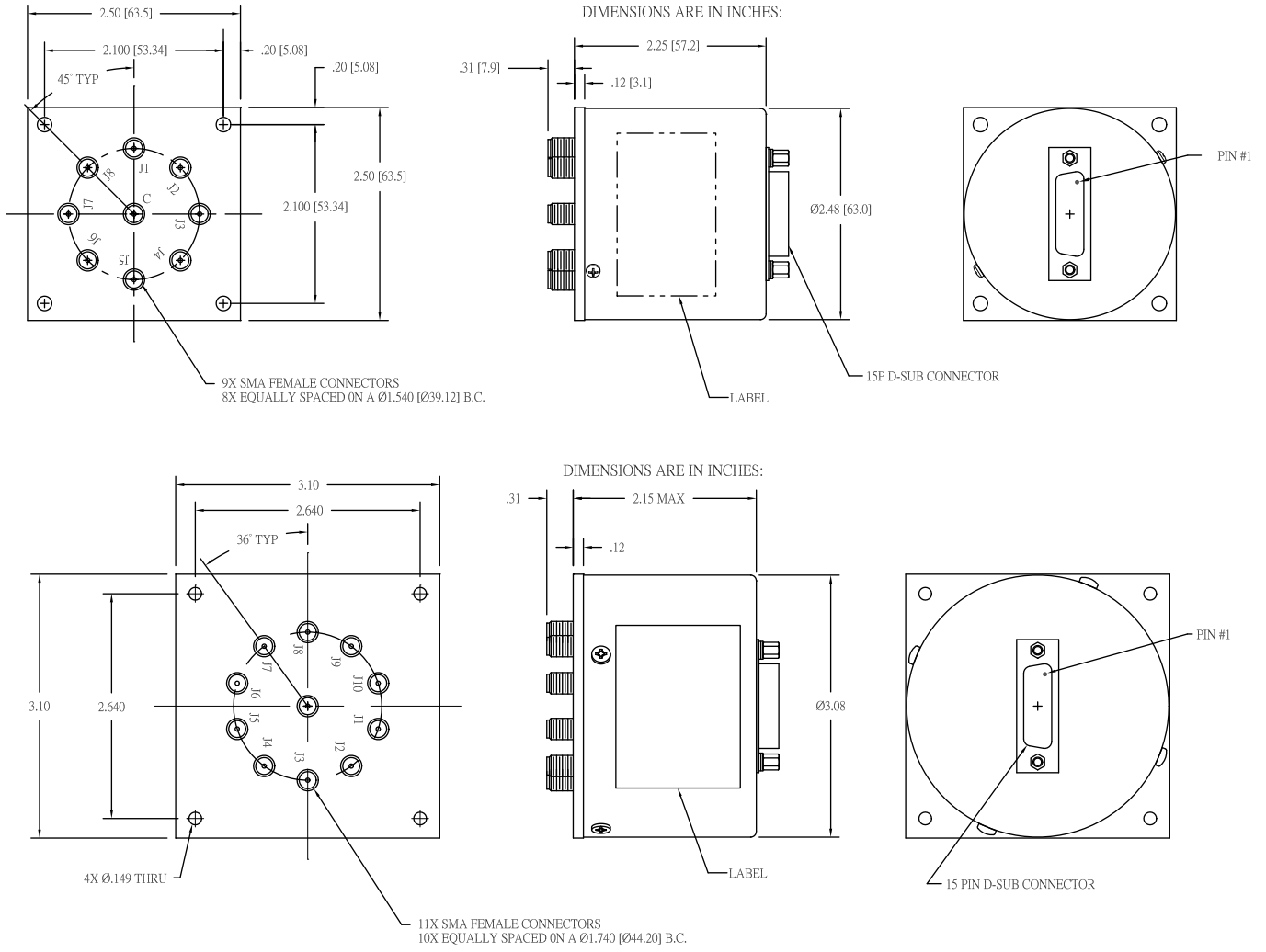

CCS-19/CS-19

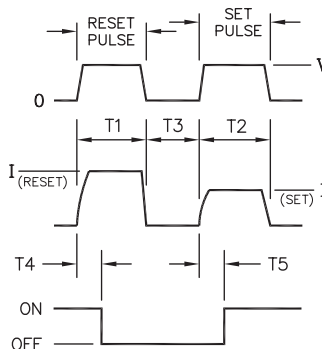
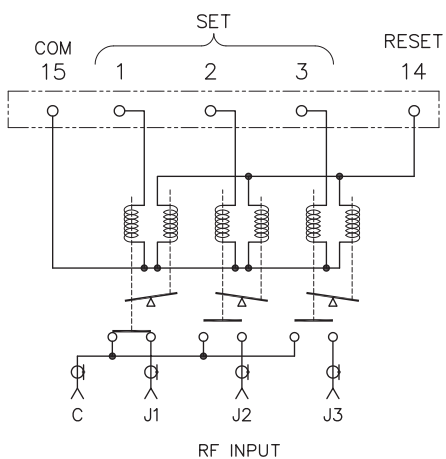
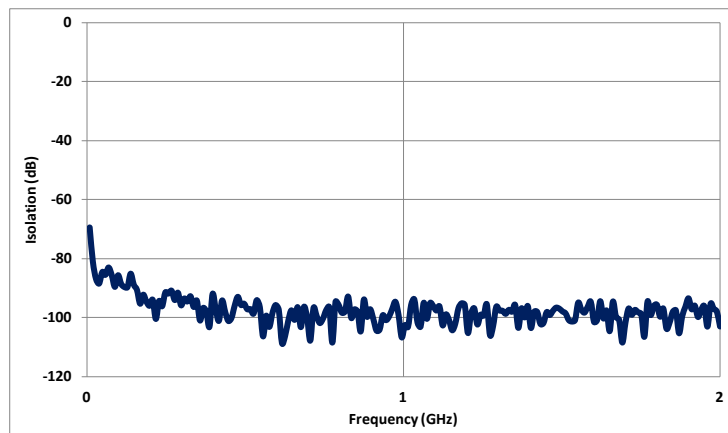
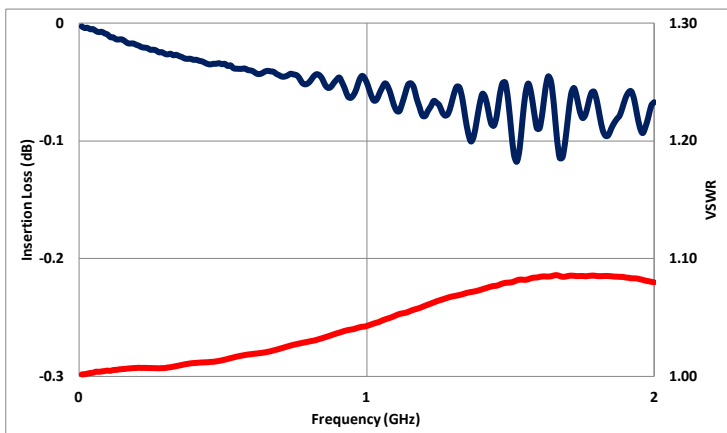

- ACTUATION CHARACTERISTICS:**
- REQUIRES TWO (2) SEQUENTIAL PULSES (RESET & SET)
 - T1 & T2 = 30 mSEC MIN
 - T3 = 10 mSEC MIN
 - T4 & T5 = 20 mSEC MAX

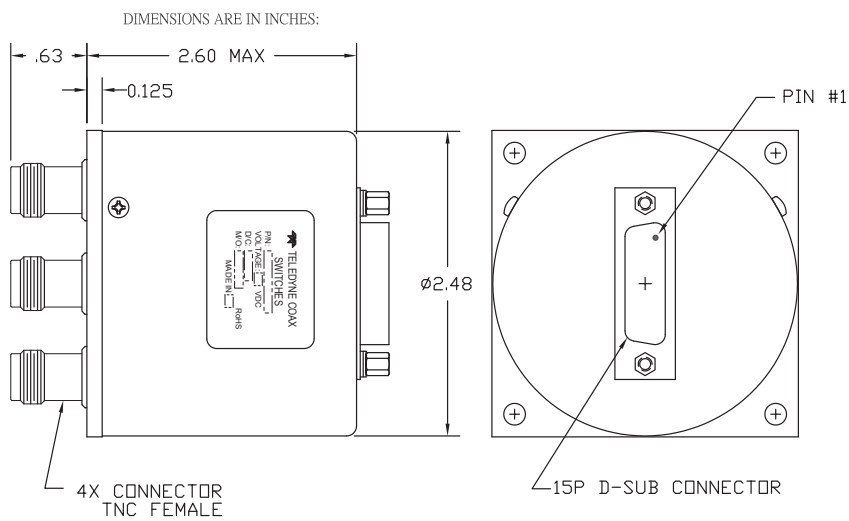
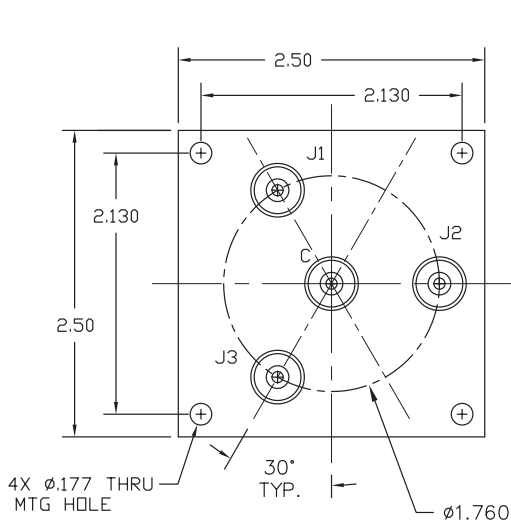

MULTI-THROW SWITCHES

CCP-32N

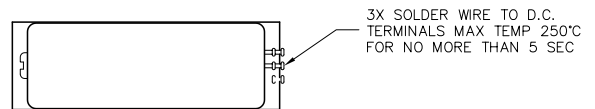
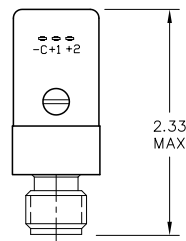
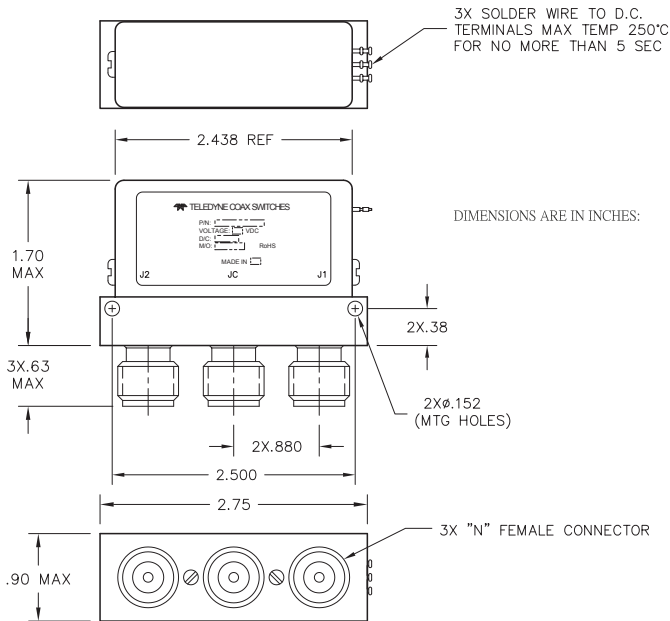
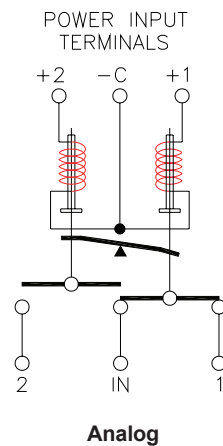
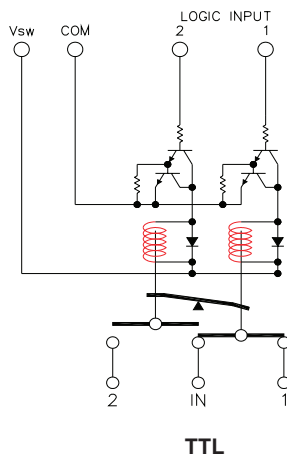
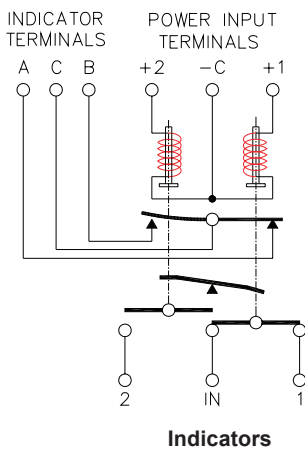
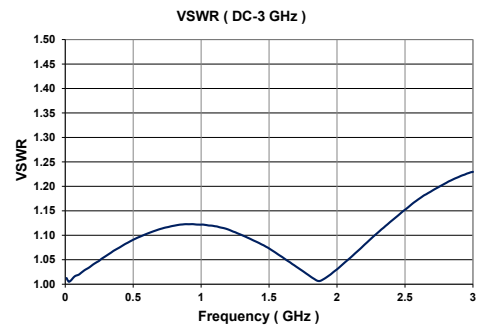
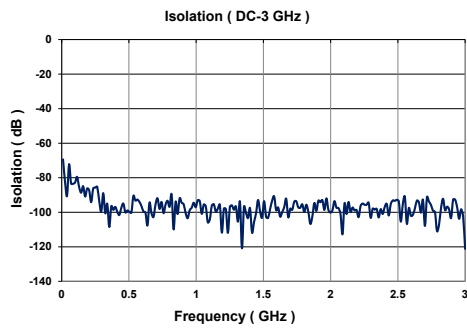
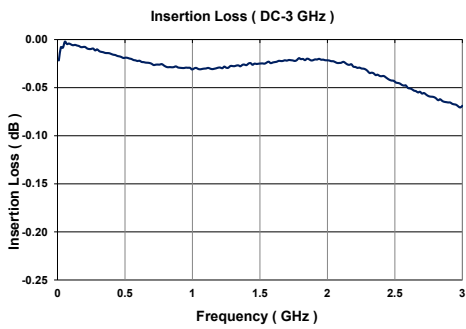

CCP-33S

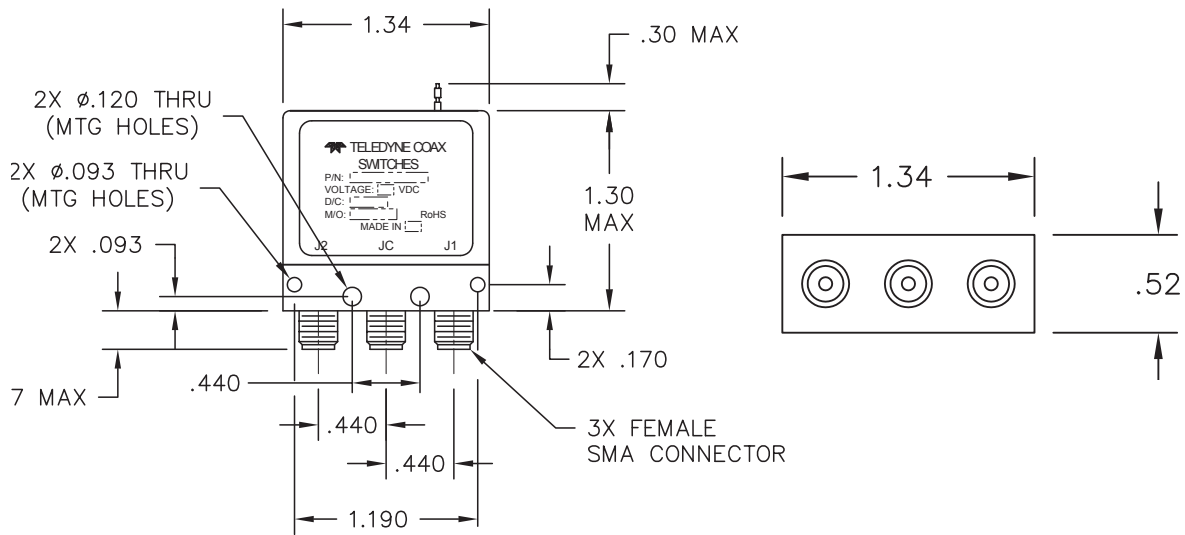
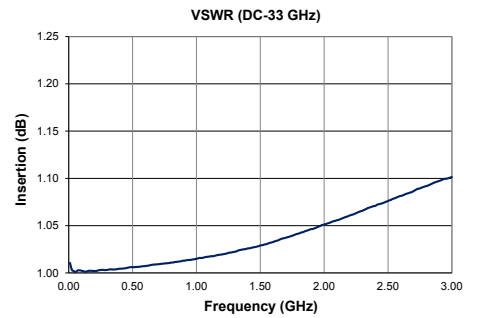
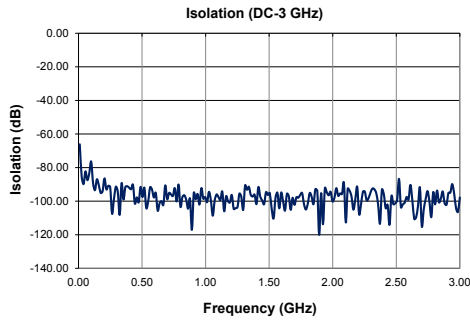
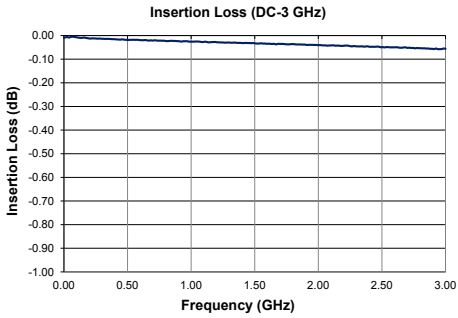

DIMENSIONS ARE IN INCHES:

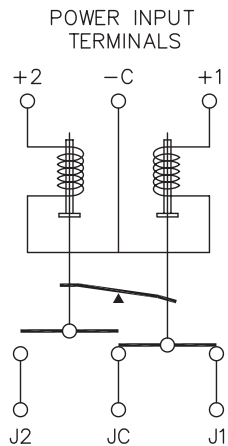

SCHEMATIC

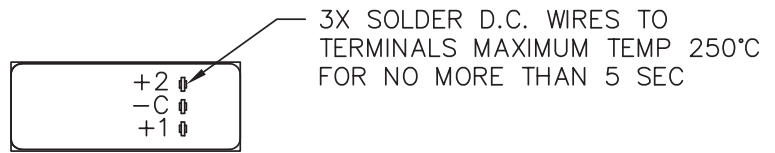

CCP-33D

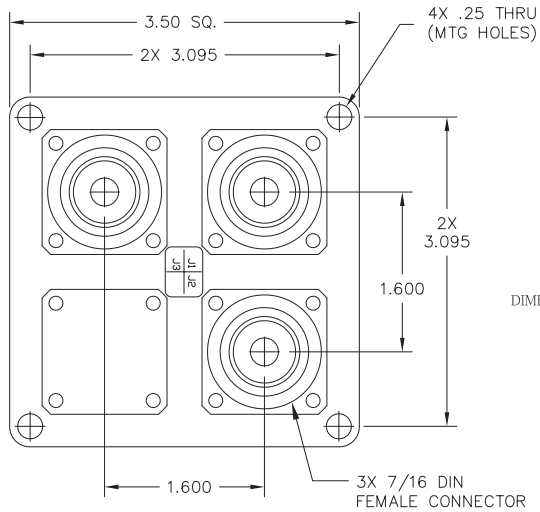
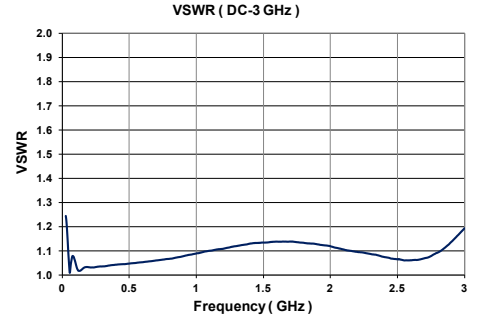
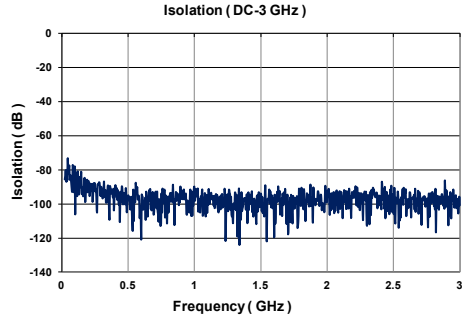
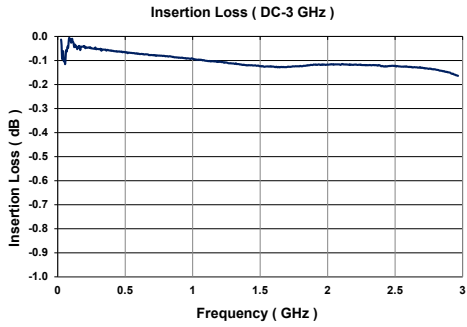

DIMENSIONS ARE IN INCHES:

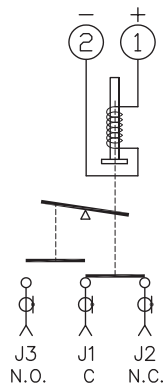
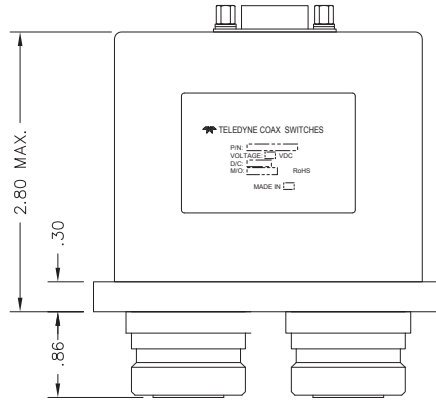

SCHMATIC

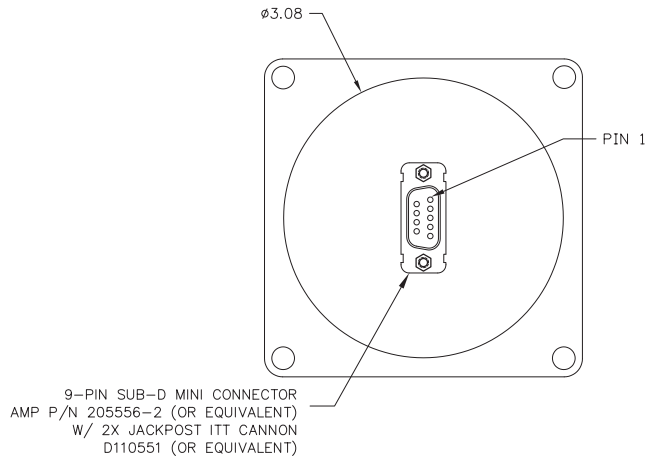

CCP-37S

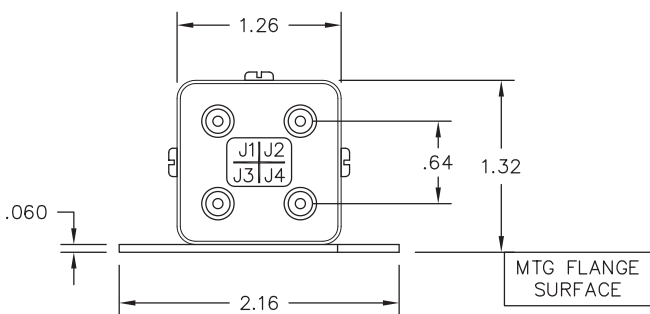
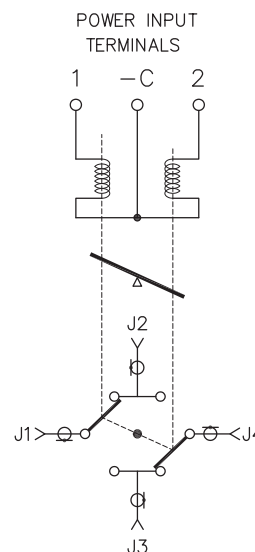
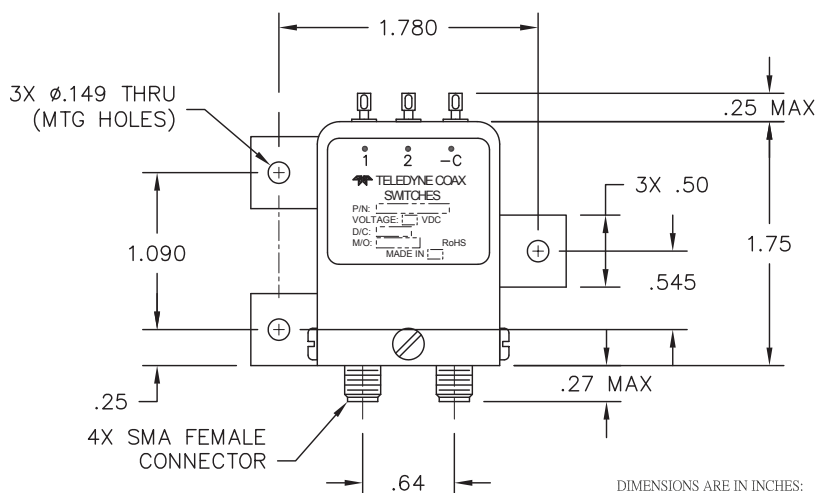
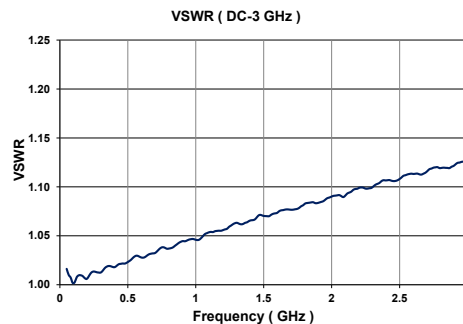
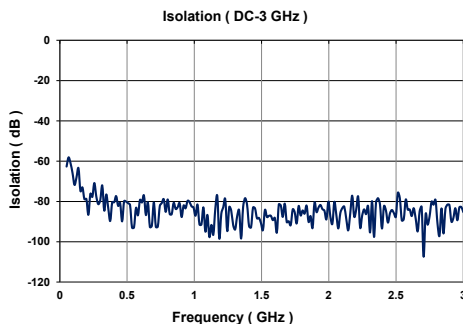
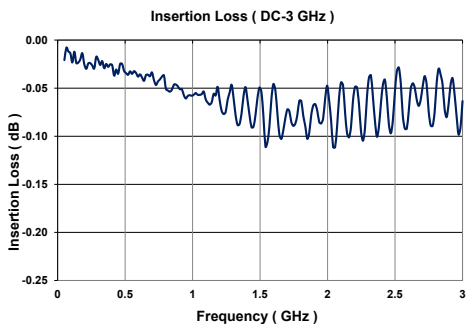

SCHMATIC

3X SOLDER WIRE TO D.C. TERMINALS MAX TEMP 250°C FOR NO MORE THAN 5 SEC

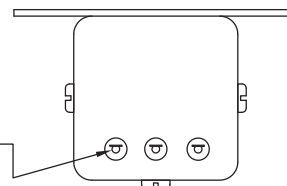

CCP-47N

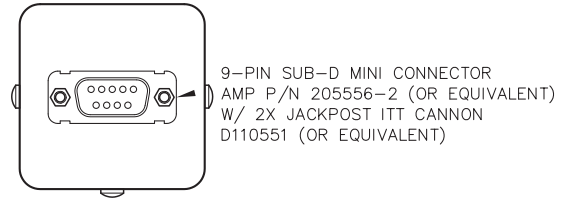
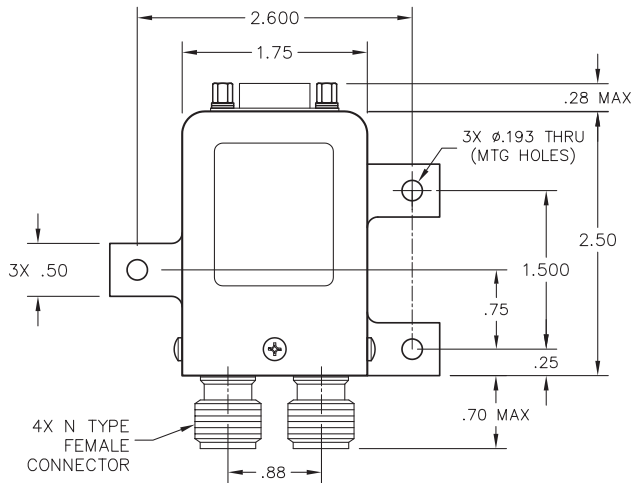
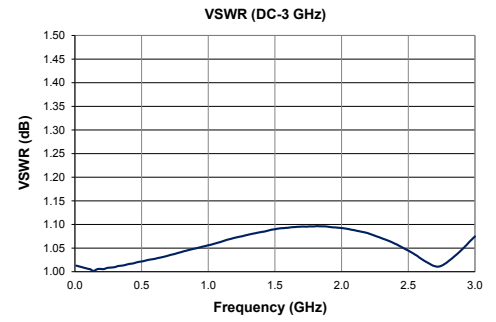
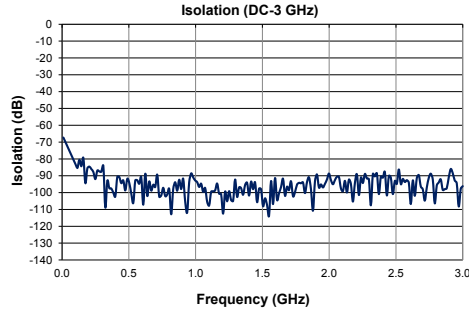
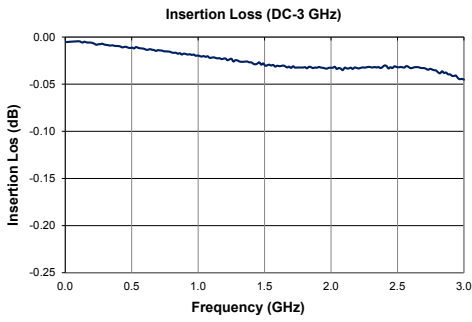

DIMENSIONS ARE IN INCHES:

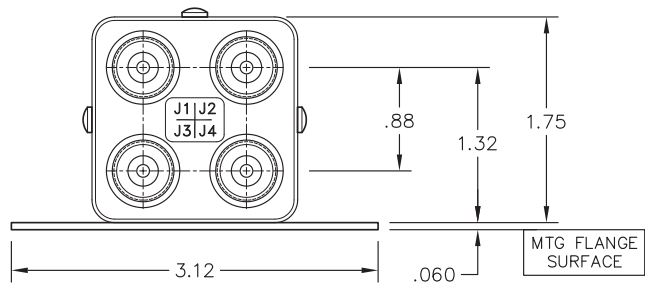
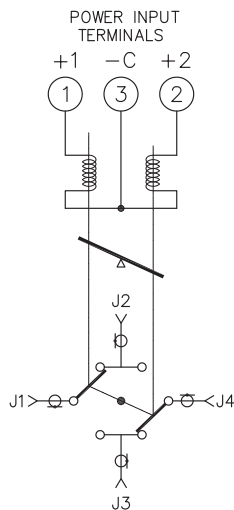

CCP-47D

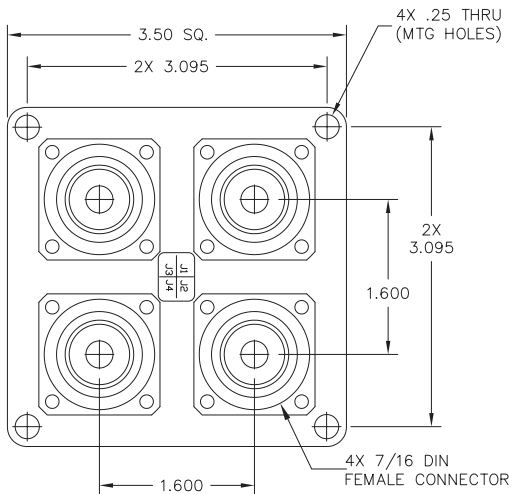
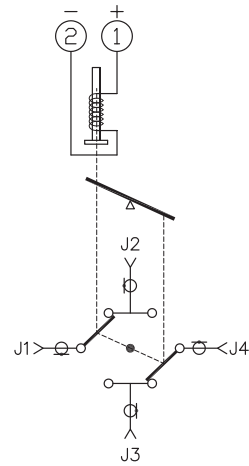
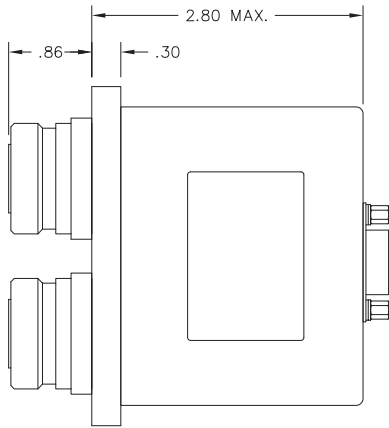
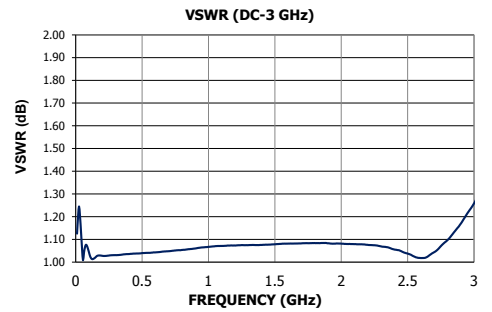
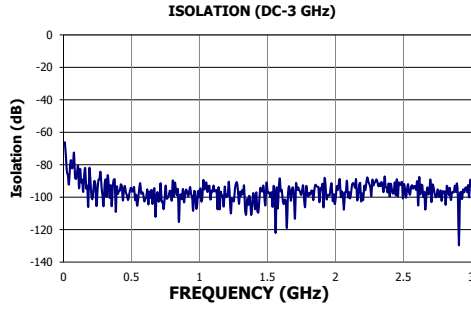
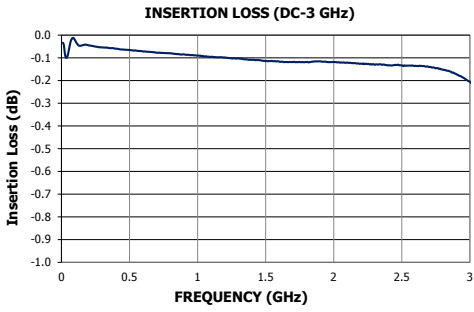

DIMENSIONS ARE IN INCHES:

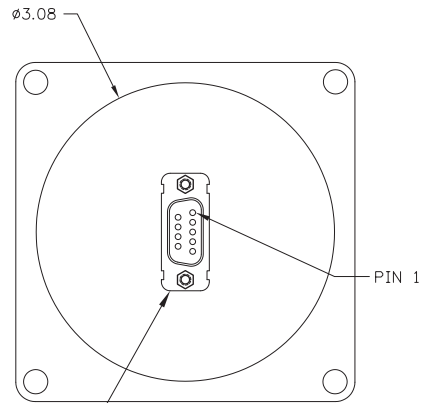

3-PIN SUB-D MINI CONNECTOR
 N 205556-2 (OR EQUIVALENT)
 W/ 2X JACKPOST ITT CANNON
 D110551 (OR EQUIVALENT)

CCP-38S

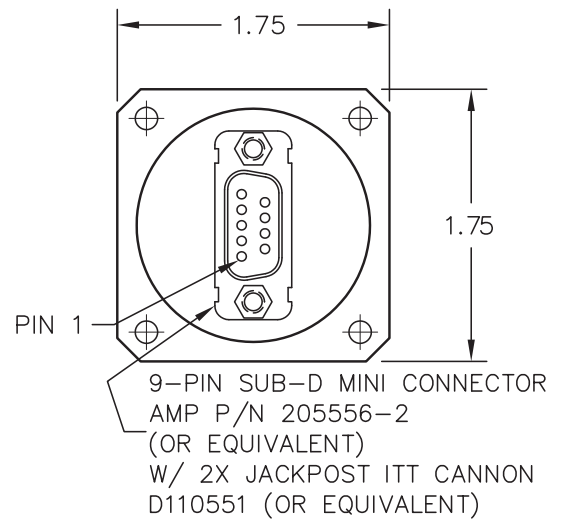
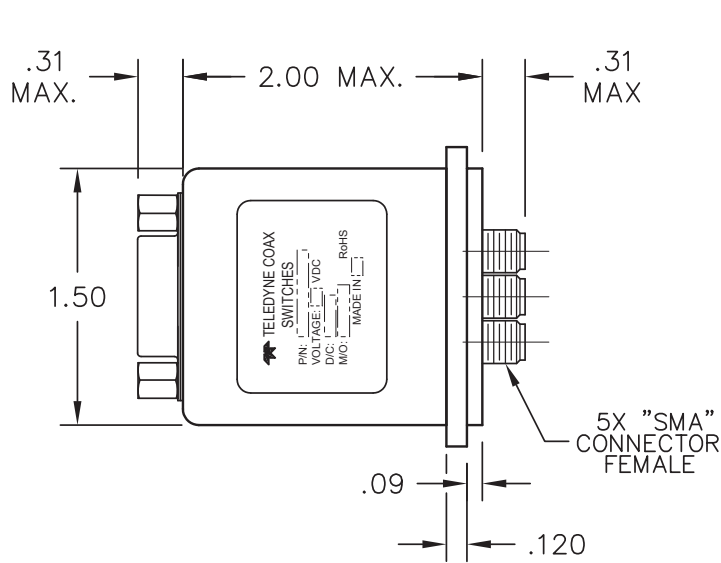
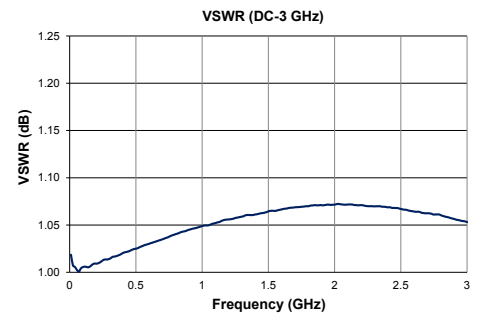
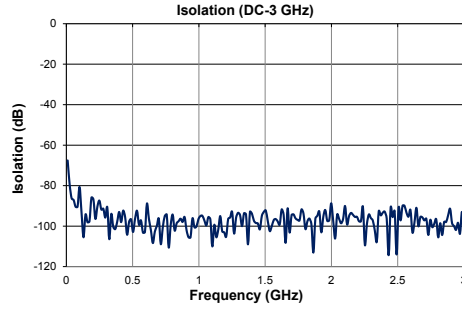
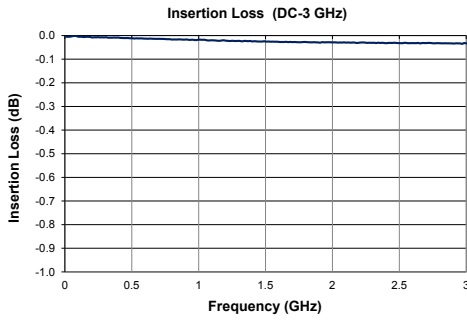

DIMENSIONS ARE IN INCHES:

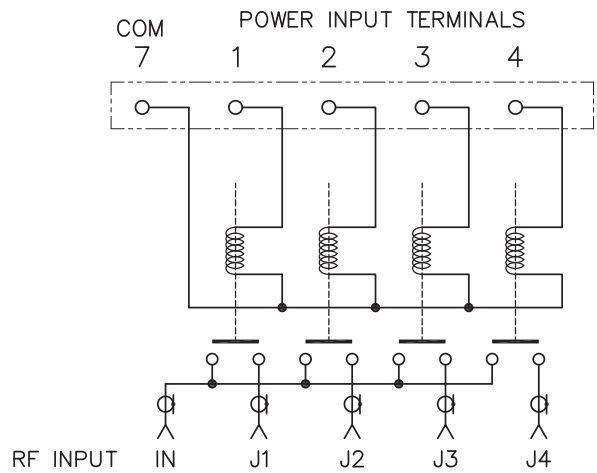
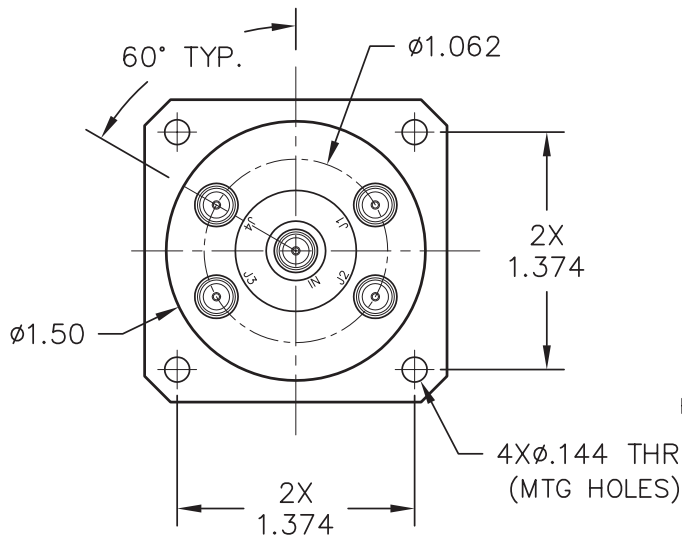

SCHEMATIC
SHOWN IN
NORMALLY OPEN POSITION

CCP-18N

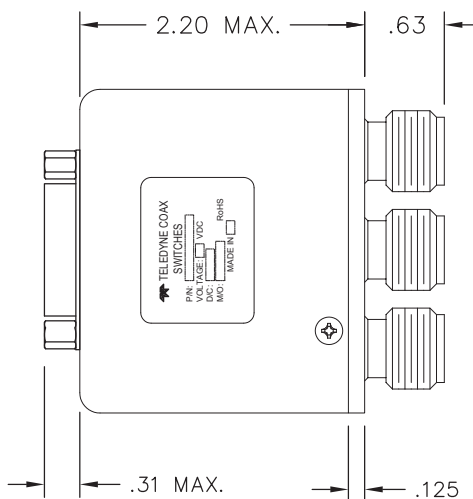
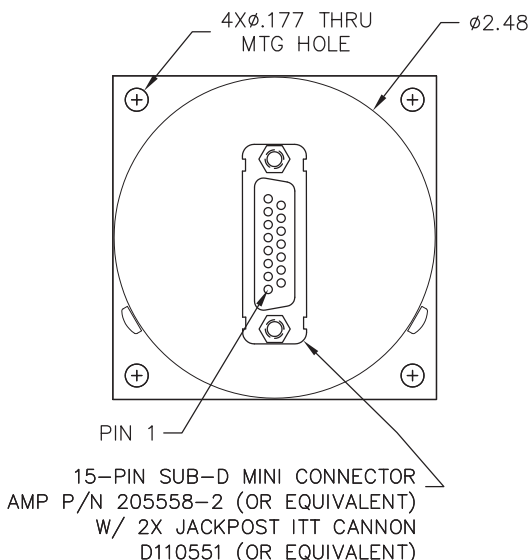
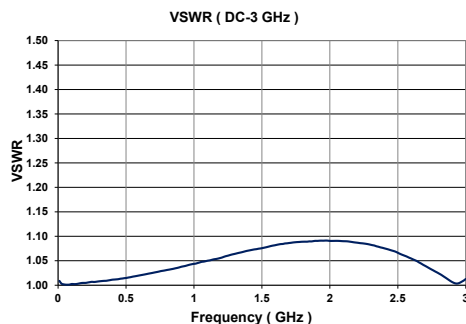
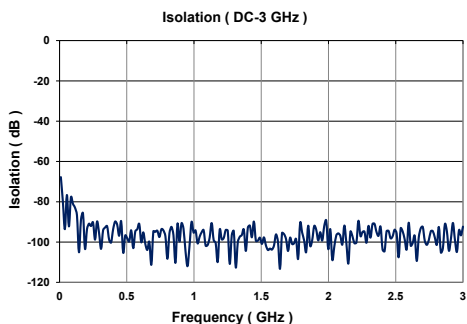
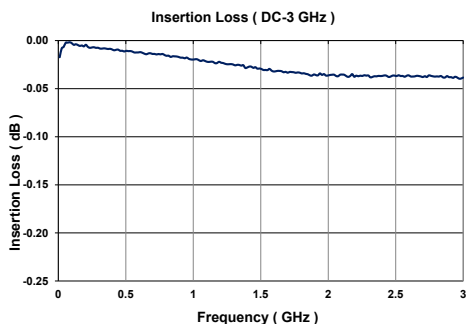

DIMENSIONS ARE IN INCHES:

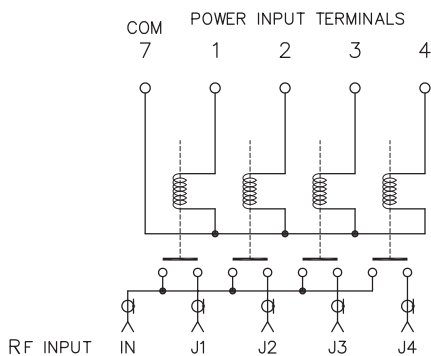

SCHMATIC
SHOWN IN
NORMALLY OPEN POSITION

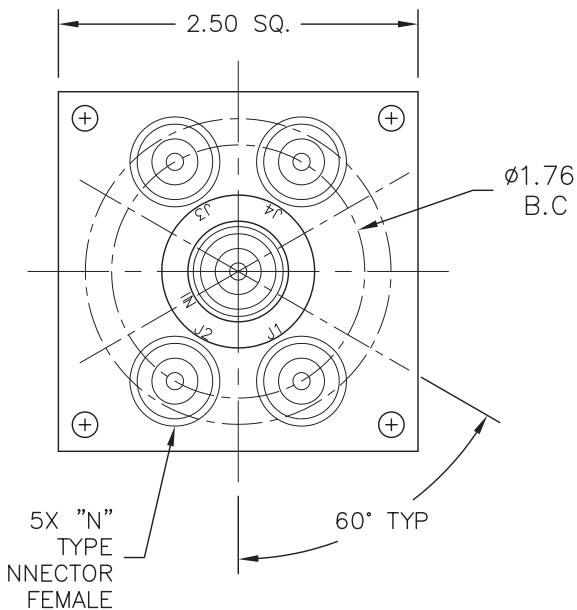

CCP-18D

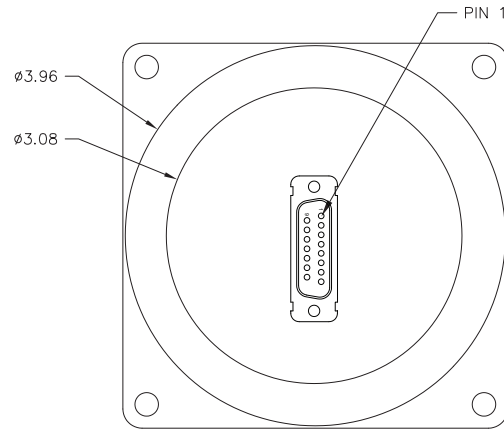
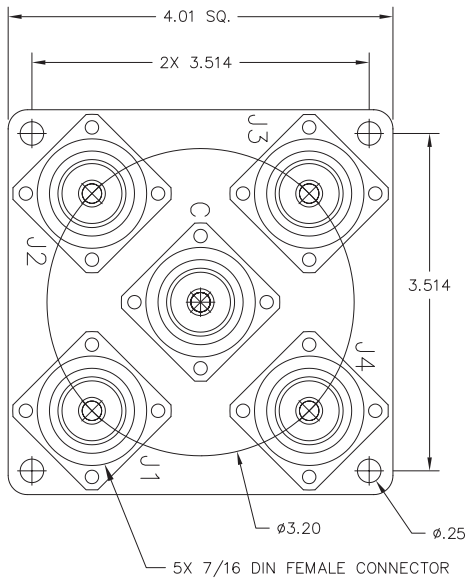
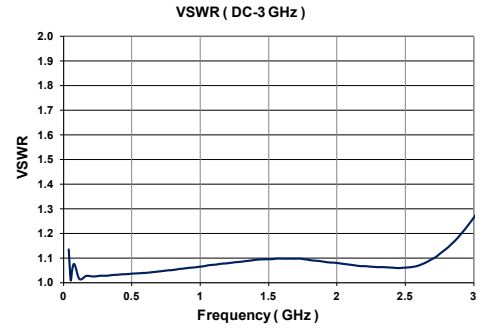
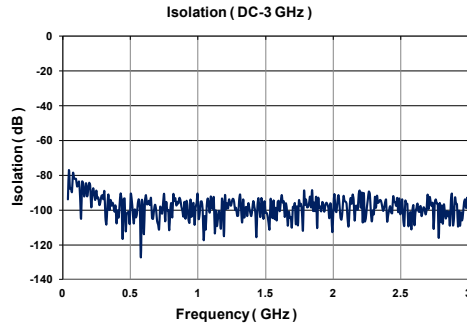
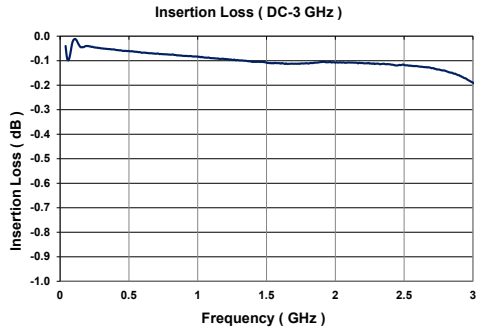

DIMENSIONS ARE IN INCHES:

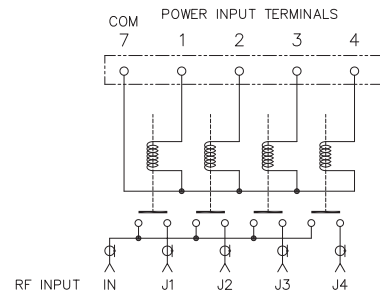
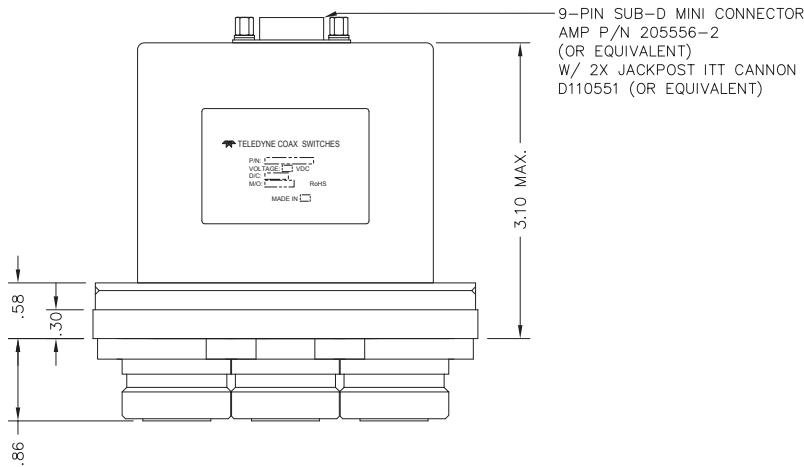

SCHEMATIC
SHOWN IN
NORMALLY OPEN POSITION

Power Handling vs Frequency Chart

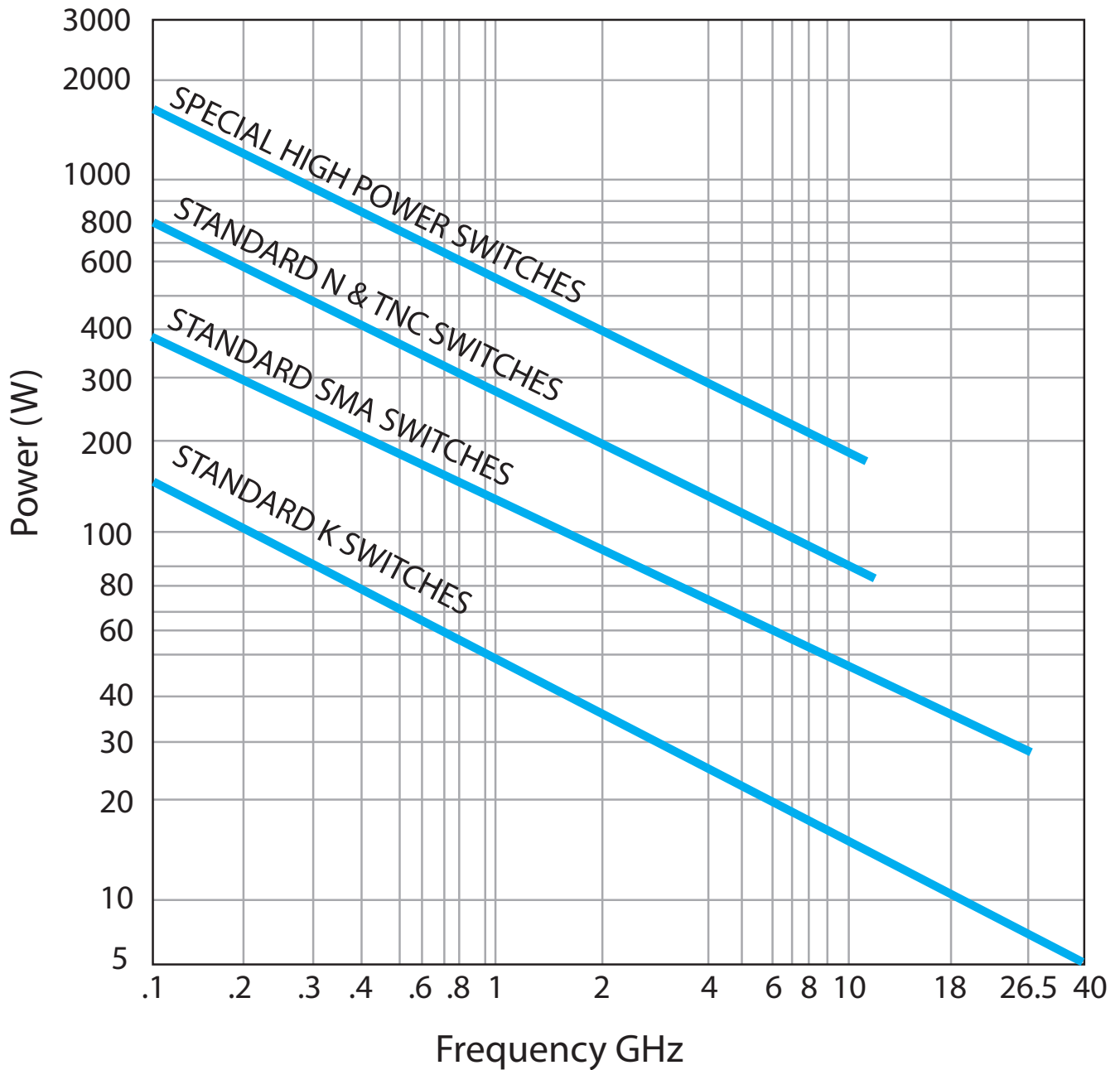

Estimates based on the following reference conditions:

- Ambient temperature of 40°C or less
- Sea level operation
- Load VSWR of 1.20:1 maximum
- No high-power (hot) switching

Please contact Teledyne Coax Switches for derating factors when applications do not meet the foregoing reference conditions.

Additional Unique Options

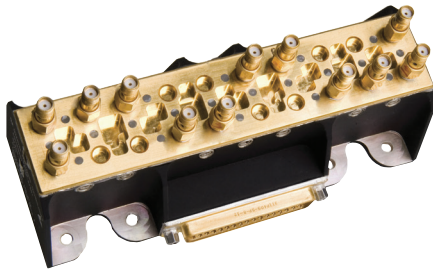

Switch Blocks

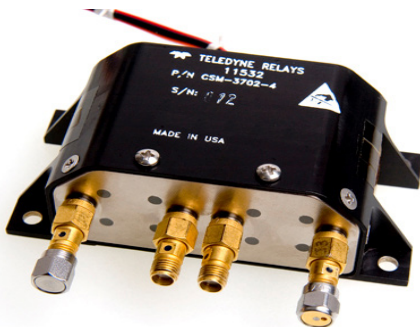

Alternative Connector Locations

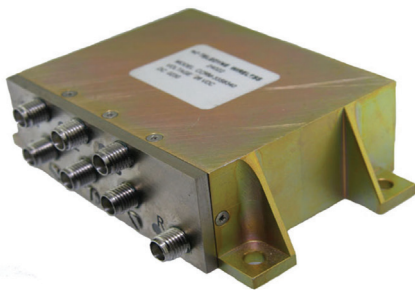

Radiation Shielding Covers



6P7T Switch



DC Long Flying Leads



PCB Pin Option



Short Cover Option

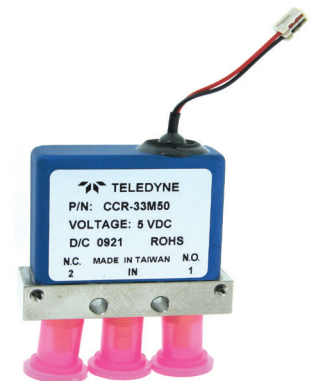

DC Flying Leads



QMA RF Connectors

Teledyne Coax Switches offers numerous options for coaxial switches:

- Double Insulation
- Radiation Shielding
- Customized Mounting Brackets
- Special Power Connectors
- Alternate RF Connectors
- Alternate DC terminal styles
- Short Covers
- PCB Mount RF Pins
- Switch Blocks
- 6P7T Switch Matrix
- Parallel or Series Diodes
- Redundant Diode Configuration
- Pressure Evacuation Vent

Please feel free to contact us for more information regarding additional options and custom configurations.

Actuator

An actuator is the electromechanical mechanism that transfers the RF contacts from one position to another upon DC command.

Arc Suppression Diode

A diode is connected in parallel with the coil. This diode limits the “reverse EMF spike” generated when the coil de-energizes to 0.7 volts. The diode cathode is connected to the positive side of the coil and the anode is connected to the negative side.

Date Code

All switches are marked with either a unique serial number or a date code. Date codes are in accordance with MIL-STD-1285 Paragraph 5.2.5 and consist of four digits. The first two digits define the year and the last two digits define the week of the year (YYWW). Thus, 0532 identifies switches that passed through final inspection during the 32nd week of 2005.

Failsafe

A failsafe switch reverts to the default or failsafe position when the actuating voltage is removed. This is realized by a return spring within the drive mechanism. This type of switch requires the continuous application of operating voltage to select and hold any position. (Multi-position switches are normally open with no voltage applied).

Latching

A latching switch remains in the selected position whether or not voltage is maintained. This can be accomplished with either a magnetic or mechanical latching mechanism.

Indicator

Indicators tell the system which position the switch is in. Other names for indicators are telemetry contacts or tellback circuit. Indicators are usually a set of internally mounted DC contacts linked to the actuator. They can be wired to digital input lines, status lights, or interlocks. Unless otherwise specified, the maximum indicator contact rating is 30 Vdc, 50 mA, or 1.5 Watts into a resistive load.

Internal Termination

Unselected ports are connected internally to a matched load. The load is a 50-Ohm resistive device. The max RF power rating is 2 watts CW. Without the internal termination option, the unselected ports are open circuits.

Isolation

Isolation is the measure of the power level at the output connector of an unconnected RF channel as referenced to the power at the input connector. It is specified in dB below the input power level.

Multi-Throw Switch

A multi-throw switch is a switch with one input and three or more output ports. The CCT-58 can switch a microwave signal to any of 2, 3, 4, 5 or 6 outputs from a single common input.

Multi-Throw Latching Switch

DUAL PULSE SWITCHING COMMAND CHARACTERISTICS:

1. APPLIES FOR SINGLE-POLE MULTI-THROW LATCHING SWITCH ONLY.
2. MUST APPLY RESET PULSE FIRST (BREAK-BEFORE-MAKE).
3. RESET AND SET DEFINITIONS
RESET: OPEN ALL RF PATHS (POSITIONS).
SET: CLOSE THE SELECTED RF PATH (POSITION).
4. COMMAND PULSE TIMING:

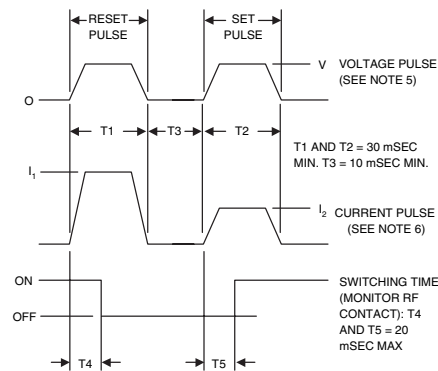

5. COMMAND SWITCHING VOLTAGE:
V = 26-32 VDC PULSE

6. SWITCHING CURRENT:

SWITCHING CURRENT AT 28 VDC AND 20°C		
NO. OF POS.	RESET (I ₁)	SET (I ₂)
3 POS.	270 mA	90 mA
4 POS.	360 mA	90 mA
5 POS.	450 mA	90 mA
6 POS.	540 mA	90 mA

Self-Cutoff

The self-cutoff option disables the actuator current on completion of actuation. Either a series contact (linked to the actuator) or an IC driver circuit provides the current cutoff. This option results in minimum power consumption by the RF switch. Cutthroat is another name used in the industry for this option. Pulse latching is a term sometimes used to describe a switch without this feature.

SPDT Switch

A single-pole double-throw switch has one input and two output ports.

Switching Time

Switching time is the total interval beginning with the arrival of the leading edge of the command pulse at the switch DC input and ending with the completion of the switch transfer, including contact bounce. It consists of three parts: (1) inductive delay in the coil, (2) transfer time of the physical movement of the contacts, and (3) the bounce time of the RF contacts.

Transfer Switch

A four-port switch consisting of two independent pairs of RF paths. These pairs are actuated simultaneously. This actuation is similar to that of a double-pole double-throw switch. See application notes for typical usage.

TTL Switch Driver Option

As a special option, switch drivers can be provided for both failsafe and latching switches, which are compatible with industry-standard low-power Schottky TTL circuits.

T-Option

This option is for TTL Driver. There is one control input for each position. See the logic table.

TD-Option

This option includes a decoder. The 3-bit parallel command is decoded to internally select the appropriate position. See the logic table.

The TD-Option increases the Vsw supply current demand by 50mA max at 28 Vdc and +20°C.

Failsafe uses 1 circuit. Latching uses 2 circuits (Vsw & C are common to both circuits).

Glossary

Performance Parameters vs Frequency

Generally speaking, the RF performance of coaxial switches is frequency dependent. With increasing frequency, VSWR and insertion loss increase while isolation decreases. All data sheets specify these parameters as “worst case” at the highest operating frequency. If the switch is to be used over a narrow frequency band, better performance can be achieved.

Actuator Current vs Temperature

The resistance of the actuator coil varies as a function of temperature. There is an inverse relationship between the operating temperature of the switch and the actuator drive current. For switches operating at 28 VDC, the approximate actuator drive current at temperature, T, can be calculated using the equation:

$$I_T = \frac{I_A}{[1 + .00385 (T-20)]}$$

Where:

I_T = Actuator current at temperature, T

I_A = Room temperature actuator current – see data sheet

T = Temperature of interest in °C

Magnetic Sensitivity

An electro-mechanical switch can be sensitive to ferrous materials and external magnetic fields. Neighboring ferrous materials should be permitted no closer than 0.5 inches and adjacent external magnetic fields should be limited to a flux density of less than 5 Gauss.

Series Application of Multi-Throw Switches

This example shows a single-pole 9-throw unit made up of four 3-throw switches. The number of throws possible using this technique is essentially unlimited and is equal to the total number of throws available in the output stage. If a two-stage unit were set up using six position switches, the resultant would be a total of 36 outputs or a SP36T switch bank. See Figure 1.

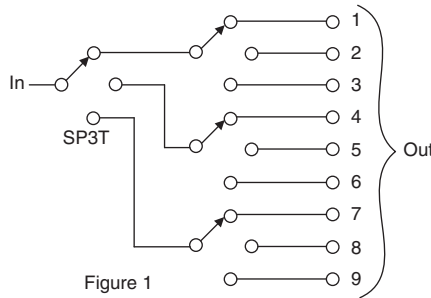

Figure 1

Transfer Switch

The transfer switch is essentially a modified double-pole-double-throw (DPDT) device. However, a true DPDT switch is a six port device that contains two totally independent transmission paths. In a transfer switch two transmission paths are provided but they are not totally independent as illustrated in Figure 2.

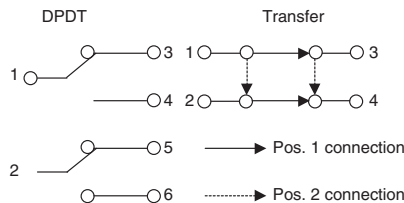

Figure 2

Examples of applications of the transfer switch are as follows:

Two Transmitters to Either of Two Antennas

Two microwave transmitters can be connected to either of two alternate antennas as shown in Figure 3.

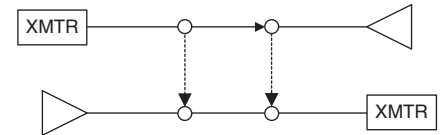

Figure 3

Circuit Insertion

A complete microwave circuit or circuit element can be inserted into a transmission line by using a transfer switch as shown in Figure 4.

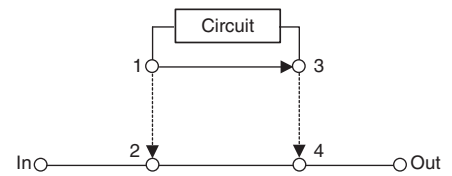

Figure 4

In the event that the 1-3 shorting of the microwave circuit is undesirable, this leg can be left out.

Special Feature

Low PIM or Highly Sensitive Signals

Ensure the most linear response with the best galvanically matched contact system in the industry. Reference tests have been done on our standard switches for Passive Intermodulation performance.

Carrier Frequency 1	Carrier Frequency 2	PIM 3rd Order Frequency	PIM 5th Order Frequency
870 MHz	893 MHz	847 MHz	824 MHz

	3rd Order Intermodulation	5th Order Intermodulation
SPDT	-91 dBm	-110 dBm
	-134 dBc	-153 dBc
Transfer	-103 dBm	-123 dBm
	-146 dBc	-165 dBc
Multiple Positions	-96 dBm	-115 dBm
	-139 dBc	-158 dBc

Teledyne, the world's innovative leader in manufacturing electromechanical and solid-state switching products for more than 50 years, offers a modular approach to matrix assembly switching.



Incorporating highly repeatable and long-cycle-life relays and switches, Teledyne's matrices cover the spectrum from DC to 40GHz. Teledyne's modular

approach to building matrices allows assembly of a vast array of customized matrix assemblies with the same standard subassemblies. The internal components of the assembly and main module utilize Teledyne's proven relays and switches. Teledyne has developed a



standard programmable microcontroller that can be used for nearly any matrix configuration.



The universal power supply allows the matrix assembly to be used worldwide. Teledyne is highly vertically integrated, which reduces development time, qualification time, cost and lead time, while ensuring high quality and cost-effective production.

To learn more, call us or visit us online today. And see what Teledyne Coaxial Switches can do for you.



FEATURES

- Fully customized switching configurations
- Universal Power Supply
- Visual Display – LED
- Standard and custom racks available
- Manual/direct and/or remote control
- Multiple interface configurations:
RF ports – SMA, 2.92mm, N, SMB, TNC, etc.
Control – RS-232, Ethernet, USB, Keypad, etc.
- 50 and 75 ohm impedances

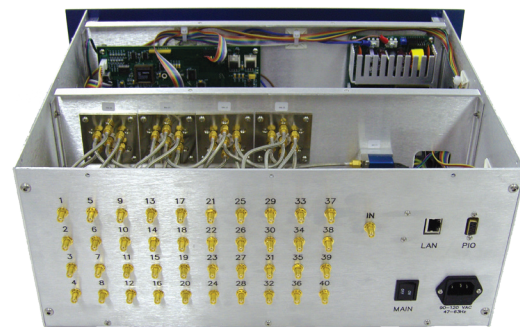

TYPICAL INSERTION LOSS / ISOLATION**

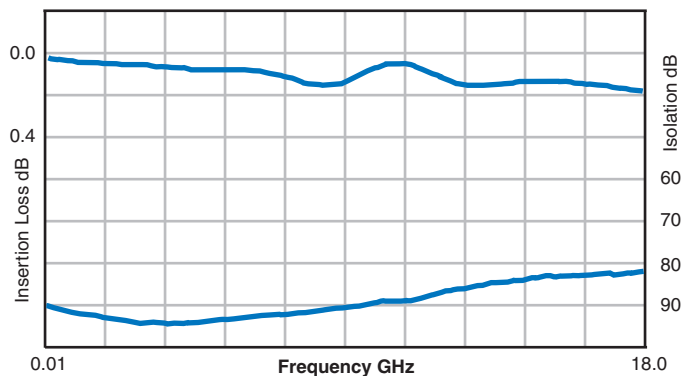



CUSTOM SWITCH MATRIX

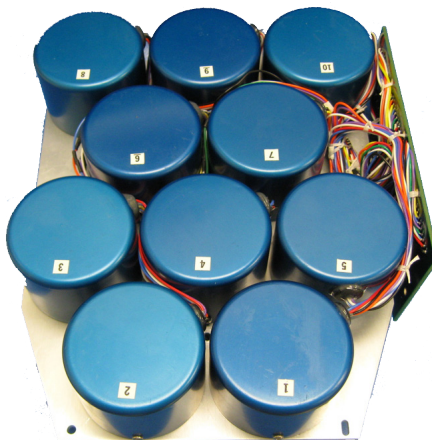
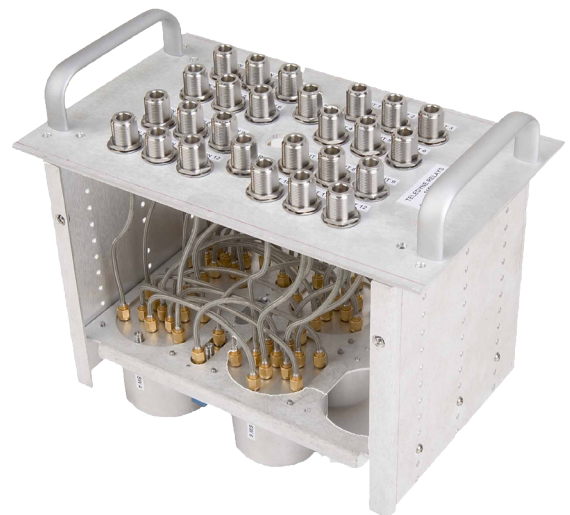

ADDITIONAL FEATURES

- Monitor cycle count
- System health/system status
- LEDs: Visual status
- In-circuit programming (firmware upgradeable)

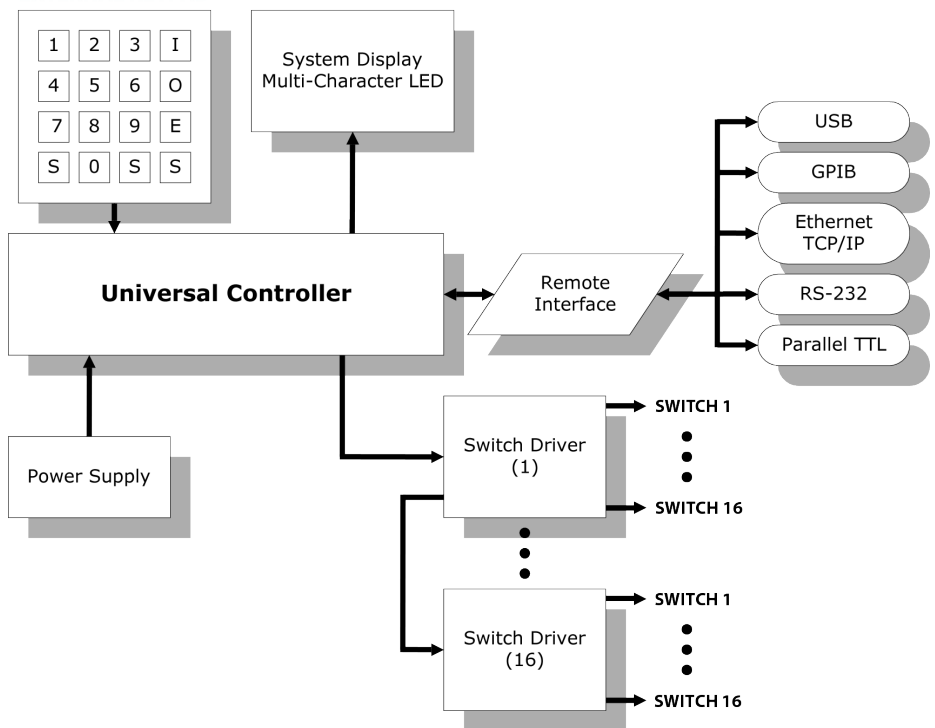

TYPICAL RETURN LOSS**

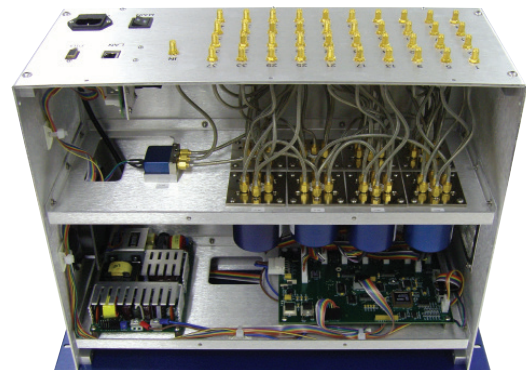
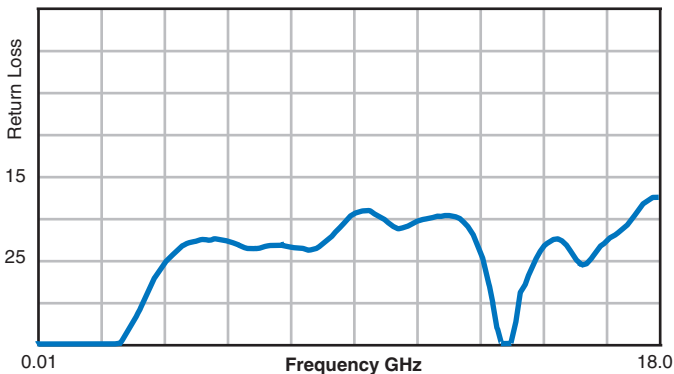

**Sample measurement from a 1x40 switch matrix. For reference only, contact factory for additional details



PART NUMBER DESCRIPTION

The MMA Series is an ideal solution that consists of SPDT, electromechanical coaxial switches designed to switch a microwave signal from a common input to either of two outputs. The characteristic impedance is 50 Ohms. The terminated option provides an impedance match for the unselected port.

The MMA Series is designed to allow the remote operation of 1 to 4 Single Pole Double Throw switches. Remote operation is accomplished via TCP/IP commands to the Matrix's Ethernet interface. Switch control is also accessible via the USB virtual serial port, using the provided command set. Through these interfaces the Coax Switch can be switched to the desired position and its position can be read for verification. The default switch position at power up can be set by the user. The MMA will feature a graphical user interface (GUI), which will enable user to control switches through graphical icons and visuals.

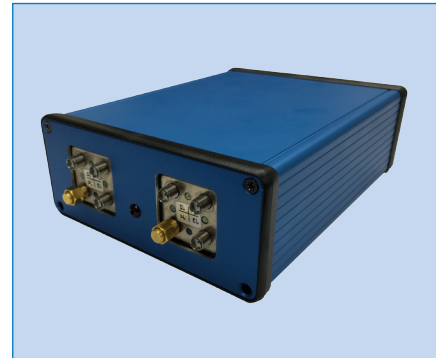

ENVIRONMENTAL AND PHYSICAL CHARACTERISTICS

Operating Temperature	-40°C to 65°C
Standard Actuator Life	5,000,000 cycles
Connector Type	SMA, 2.92mm, N, TNC, SMB
Weight Non-Terminated	
1 Switch	18 oz. (510 g) (max.)
2 Switches	20 oz. (567 g) (max.)
4 Switches	23 oz. (652 g) (max.)
Weight Terminated	
1 Switch	60 oz. (1701 g) (max.)
2 Switches	62 oz. (1758 g) (max.)
4 Switches	64 oz. (1814 g) (max.)

ELECTRICAL CHARACTERISTICS (SWITCHES ONLY)

Form Factor	SPDT, break before make
Frequency Range	Up to DC-40 GHz
Characteristic Impedance	50 Ohms, 75 Ohms (SMB only)
Operate Time	15 ms (max.)
Release Time	15 ms (max.)
Actuation Voltage	24Vdc
Actuation Current, max. @ ambient	Varies

ADDITIONAL INFORMATION

Interface	USB or TCP/IP
Host Operating System	Windows, MAC, Linux
Operating System	Embedded

INCLUDED ITEMS

• AC/DC Power Adapter	• USB Cable
• Power Cord	• Installation CD
• Ethernet Cable	

BLOCK DIAGRAM EXAMPLE

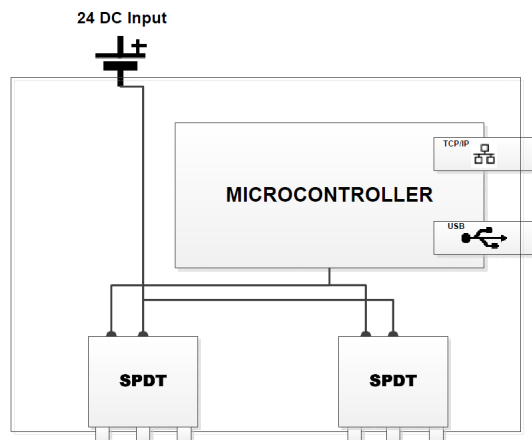

PART NUMBER DESCRIPTION

The MMB Series is an ideal solution that consists of Transfer, electromechanical coaxial switches designed to switch a microwave signals in a DPDT configuration. The characteristic impedance is 50 Ohms.

The MMB Series is designed to allow the remote operation of 1 to 4 Transfer switches. Remote operation is accomplished via TCP/IP commands to the Matrix's Ethernet interface. Switch control is also accessible via the USB virtual serial port, using the provided command set. Through these interfaces the Coax Switch can be switched to the desired position and its position can be read for verification. The default switch position at power up can be set by the user. The MMB will feature a graphical user interface (GUI), which will enable user to control switches through graphical icons and visuals.



ENVIRONMENTAL AND PHYSICAL CHARACTERISTICS

Operating Temperature	-40°C to 65°C
Standard Actuator Life	5,000,000 cycles
Connector Type	SMA, N, TNC
Weight Enclosure A - SMA Models	
1 Switch	22 oz. (624 g) (max.)
2 Switches	24 oz. (680 g) (max.)
Weight Enclosure B - SMA Models	
2 Switches (N or TNC)	72 oz. (2041 g) (max.)
4 Switches	64 oz. (1814 g) (max.)

ELECTRICAL CHARACTERISTICS (SWITCHES ONLY)

Form Factor	DPDT, break before make
Frequency Range	Up to DC-26.5GHz
Characteristic Impedance	50 Ohms
Operate Time	15 ms (max.)
Release Time	15 ms (max.)
Actuation Voltage	24Vdc
Actuation Current, max. @ ambient	Varies

ADDITIONAL INFORMATION

Interface	USB or TCP/IP
Host Operating System	Windows, MAC, Linux
Operating System	Embedded

INCLUDED ITEMS

• AC/DC Power Adapter	• USB Cable
• Power Cord	• Installation CD
• Ethernet Cable	

BLOCK DIAGRAM EXAMPLE

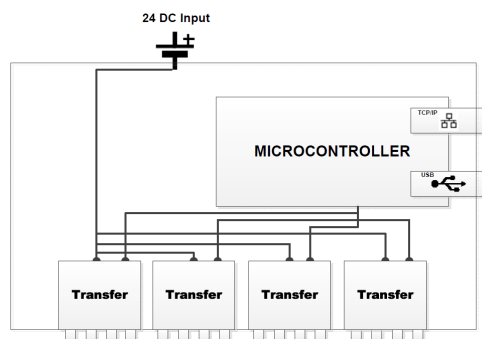

PART NUMBER DESCRIPTION

The MMC Series is an ideal solution that consists of multi-throw, electromechanical coaxial switches designed to switch a microwave signal from a common input to any of 3, 4, 5, 6, 7 or 8 outputs. The characteristic impedance is 50 Ohms. With the normally open actuator, all paths are open when the switch is de-energized.

The MMC Series is designed to allow the remote operation of 1 to 2 Single Pole Multi Throw switches. Remote operation is accomplished via TCP/IP commands to the Matrix's Ethernet interface. Switch control is also accessible via the USB virtual serial port, using the provided command set. Through these interfaces the Coax Switch can be switched to the desired position and its position can be read for verification. The default switch position at power up can be set by the user. The MMC will feature a graphical user interface (GUI), which will enable user to control switches through graphical icons and visuals.

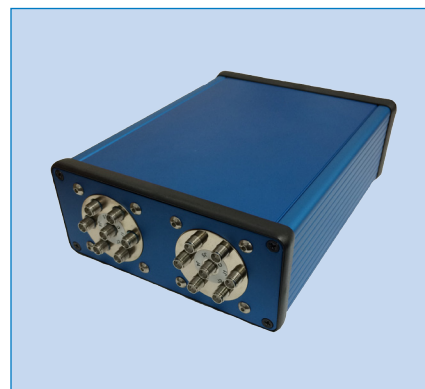

ENVIRONMENTAL AND PHYSICAL CHARACTERISTICS

Operating Temperature	-40°C to 65°C
Standard Actuator Life	5,000,000 cycles
Connector Type	SMA, 2.9mm
Weight Non-Terminated	
1 Switch	26 oz. (737 g) (max.)
2 Switches	32 oz. (907 g) (max.)
Weight Terminated	
1 Switch	54 oz. (1531 g) (max.)
2 Switches	60 oz. (1701 g) (max.)

ELECTRICAL CHARACTERISTICS (SWITCHES ONLY)

Form Factor	Multi-Throw, break before make
Frequency Range	Up to DC-40 GHz
Characteristic Impedance	50 Ohms
Operate Time	15 ms (max.)
Release Time	15 ms (max.)
Actuation Voltage Available	24 Vdc
Actuation Current, max. @ ambient	170mA/switch

TYPICAL RF CHARACTERISTICS

Frequency	DC-6 GHz	6-12 GHz	12-18 GHz	18-26.5 GHz	26.5-34 GHz* (40 Option)	34-40 GHz* (40 Option)
Insertion Loss, dB, typ.	0.20	0.40	0.50	0.90	1.00	1.50
Isolation, dB, typ..	70	60	60	50	50	50
VSWR, typ.	1.25:1	1.40:1	1.50:1	1.80:1	1.90:1	2.00:1

For specific RF performance data please refer to Coax Switch Part number list in Glossary (page 5)

ADDITIONAL INFORMATION

Interface	USB or TCP/IP
Host Operating System	Windows, MAC, Linux
Operating System	Embedded

INCLUDED ITEMS

- AC/DC Power Adapter
- USB Cable
- Power Cord
- Installation CD
- Ethernet Cable

BLOCK DIAGRAM EXAMPLE

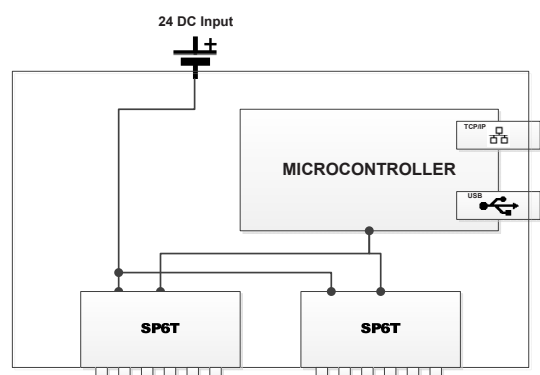

Miniature Coax Switch Matrix Enclosure Dimensions

MECHANICAL OUTLINE FOR ENCLOSURE A

- MMA:** Up to 4 Non-Terminated SPDT Switches
Up to 2 Terminated SPDT Switches
Up to 1 Non-Terminated N/TNC SPDT Switches
- MMB:** Up to 2 Transfer/2P3T Switches
- MMC:** Up to 2 Non-Terminated Failsafe SP6T Multi-Throw Switches

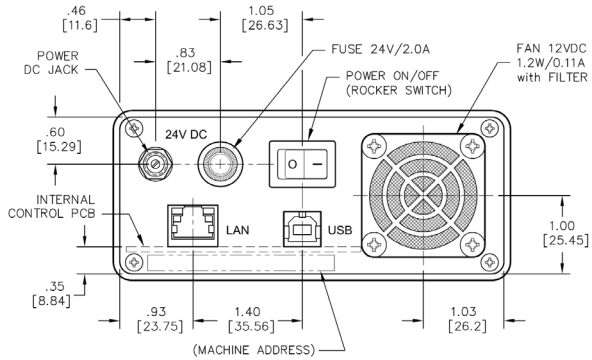

ENCLOSURE A BACK VIEW

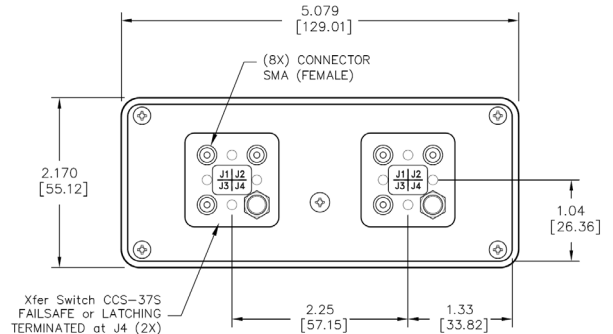

ENCLOSURE A FRONT VIEW

MECHANICAL OUTLINE FOR ENCLOSURE B

- MMA:** Up to 4 Terminated SPDT Switches
Up to 4 Non-Terminated N/TNC SPDT Switches
- MMB:** Up to 4 Transfer/2P3T Switches
- MMC:** Up to 2 Non-Terminated Latching SP6T Multi-Throw Switches or
Up to 2 Terminated SP6T Multi-Throw Switches or
Up to 2 Non-Terminated/Terminated Failsafe SP7T-SP8T Multi-Throw Switches

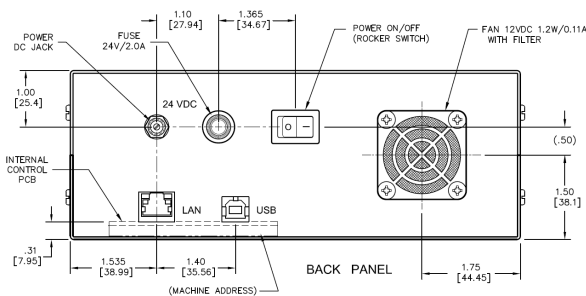

ENCLOSURE B BACK VIEW

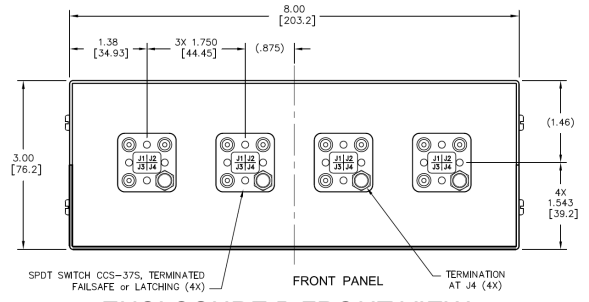

ENCLOSURE B FRONT VIEW

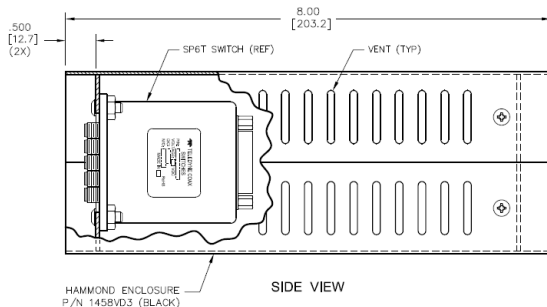

ENCLOSURE B SIDE VIEW

* Dimensions Shown in inches(millimeters)

Series RF121 / GRF121

SPDT Magnetic-Latching
Up to DC-18GHz RF Relay
Signal Integrity up to 40Gbps





Series GRF121 Electromechanical Relays

The ultraminiature GRF121 relay is designed to provide a practical surface-mount switching solution with RF performance and repeatability to 18GHz. The GRF121 improves on Teledyne Relays' heritage of miniature RF relays by incorporating a precision transmission line structure in the internal construction of the contact system. GRF121 relays feature a unique ground shield to facilitate surface mounting and to extend the frequency range when compared to through-hole solutions.

- Broader bandwidth (DC - 18GHz)
- Excellent Signal integrity up to 40Gbps
- Hermetically Sealed
- High Resistance to ESD
- Metal Enclosure for EMI shielding
- High Repeatability
- 3 Million Cycle Life

Relay Type
SPDT Magnetic-Latching
Frequency Range
RF121 = DC - 12 GHz GRF121 = DC - 18 GHz
Bit Rate
RF121 = 20 Gbps GRF121 = 40 Gbps
Mounting
RF = Thru-hole GRF = Surface-Mount (Stub)
Available Coil Voltages
5V: Coil Resistance (Ω) = 61 12V: Coil Resistance (Ω) = 500
Temperature
Storage: -65°C to $+125^{\circ}\text{C}$ Operating: -55°C to $+85^{\circ}\text{C}$

Part No.	Typical RF Performance			
	Frequency (GHz)	VSWR (max)	Isolation (dB)	Insertion Loss (dB) (max)
 RF121	DC - 4	1.3 : 1	55	0.25
	4 - 8	1.50 : 1	50	0.45
	8 - 12	2.0 : 1	40	1.35
 GRF121	DC - 4	1.1 : 1	65	0.2
	4 - 8	1.20 : 1	50	0.2
	8 - 12	1.35 : 1	40	0.5
	12 - 16	2.0 : 1	30	0.95
	16 - 18	2.3 : 1	30	1.1

RF121 : 20 Gbps

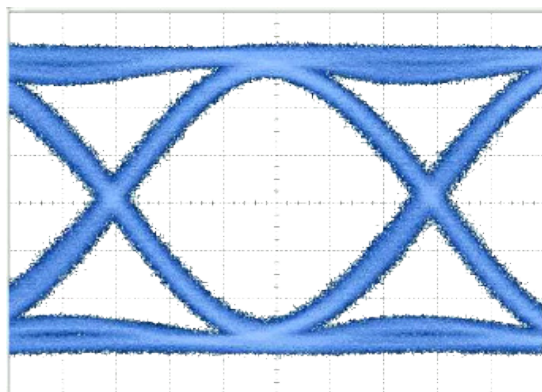

Bit Rate	Eye Height	Eye Width	Jitter _{p,p}
20 Gbps	360 mV	40.3 ps	6.93 ps

PATTERN GENERATOR SETTINGS

- 20 Gbps Random Pulse Pattern Generator
- $2^{31} - 1$ PRBS signal
- PRBS output of 500 mV_{p,p} (nominal)
- RF PCB effect (negligible) not removed from measurement
- Data shown is typical of both contacts

GRF121 : 40 Gbps

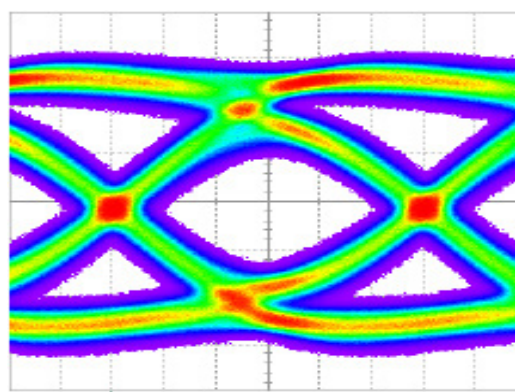

Bit Rate	Eye Height	Eye Width	Jitter _{p,p}
40 Gbps	95 mV	13.34 ps	8.73 ps

PATTERN GENERATOR SETTINGS

- 40 Gbps Random Pulse Pattern Generator
- $2^{31} - 1$ PRBS signal
- PRBS output of 500 mV_{p,p} (nominal)
- RF PCB effect (negligible) not removed from measurement
- Data shown is typical of both poles

Description

The InP1012 is a highly compact, reflective SPDT Active RF switch, manufactured using Teledyne's high speed, low-loss InP HEMT process. The switch die is packaged in a low-loss, surface mount package, with a small form factor: 3mm(L) x 3mm(W) x 1mm(H). It supports a wide frequency range from DC to 60 GHz, and delivers low insertion loss, fast switching time, and good isolation-making this switch ideal for test and measurement, microwave communications, and radar applications. The unique construction features and manufacturing techniques provide excellent robustness to environmental extremes and overall high reliability

Features

- DC - 60GHz bandwidth
- High digital bandwidth, greater than 40Gbps
- -65°C to 125°C operating temperature
- Low insertion loss
- Very fast switching time of less than 100ns

Frequency Range
DC - 60 GHz
Bit Rate
40+ Gbps
Operate Time
60-100ns
Enclosure
Low-Loss Surface Mount Package
Dimensions
3mm (L) x 3mm (W) x 1mm (H)
Temperature
Operating: -65°C to +125°C

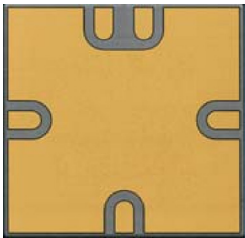
Part No.	Typical RF Performance			
	Frequency	Insertion Loss (dB)	Isolation (dB)	Return Loss (dB)
 InP1012	DC	2.0	---	---
	10kHz	0.9	67	---
	100 MHz	1.2	60	23
	6 GHz	1.6	37	21
	14 GHz	2.0	30	21
	20 GHz	2.3	27	23
	30 GHz	2.6	24	26
	40 GHz	2.9	21	25
	50 GHz	3.3	19	25
	60 GHz	3.7	17	16

TYPICAL SIGNAL INTEGRITY CHARACTERISTICS @ 40 Gbps

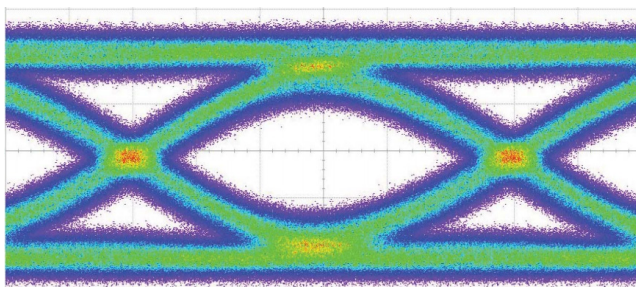

PATTERN GENERATOR SETTINGS

- 2³¹-1 PRBS signal
- 40Gbps data rate
- Data amplitude of 500mVpp

OUTLINE DIMENSIONS

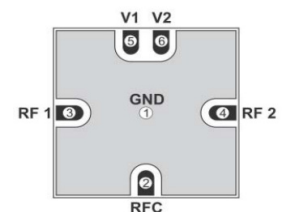
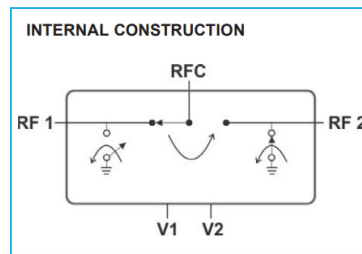
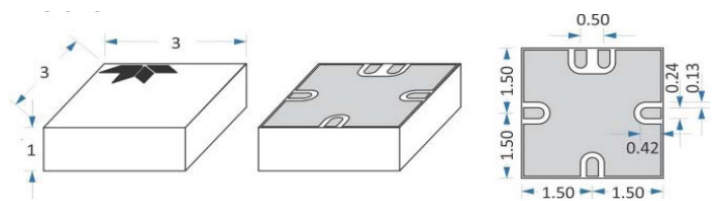

Teledyne has over 50 years of experience in developing a wide spectrum of custom solutions.

Experienced in Custom Hybrid Solutions

Teledyne Relays is a leading manufacturer with the capability of providing build-to-print solutions on hybrid microcircuits devices. Our current products portfolio includes solid state power controllers, DC/DC converters, high current drivers, digital-analog converters, activator control hybrids, deflection amplifiers, base drivers, custom designed multi-layers thick-film/thin film substrates and many more...

With over 50 years of heritage in serving the space, aerospace, and defense markets, Teledyne continues to uphold the same standards and commitment to excellence. Our optimized solutions are supported by teams of engineers and manufacturing personnel with wide ranging experiences in developing products deployed in highly demanding applications, such as electrical power systems, radar receivers, and stores management solutions, for ground or aerial defense platforms.

Teledyne is accredited by Defense Logistics Agency (DLA) in accordance with MIL-PRF-38534, Class H and Class G Qualified Manufacturers List (QML). Since 2014 Teledyne has successfully launched over twenty hybrids into production for our customers. We welcome opportunities to partner with our customers to provide customized solutions to your hybrid needs. Our typical custom solution development cycle is as follows:



Teledyne Relays offers electromechanical relays for various markets?

RF RELAYS

- Signal Integrity up to 40Gbps
- DC - 18GHz
- Surface-Mount
- DPDT, SPDT, 4PST and Loopback Relays

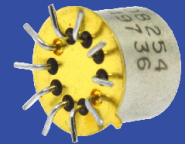

MILITARY GRADE RELAYS

- Built and tested to meet MIL-PRF-39016
- Built and tested to meet MIL-PRF-28776
- Built-in Diodes, Transistor Driver and CMOS
- Low Power coils

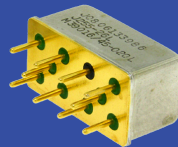

TELEDYNE ESTABLISHED RELIABILITY RELAYS

- Fully defined product requirements and screening levels
- Spacer/Spreader pad options not allowed by military specifications
- Reduced lead time and cost vs Military Grade

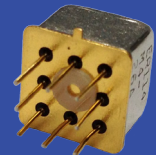
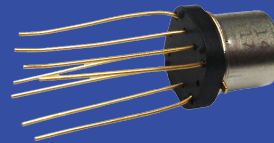
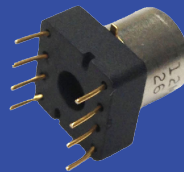

HIGH PERFORMANCE RELAYS

- -65 °C to +200 °C
- Shock up to 4,000 g's
- Vibration up to 380 g's
- Non-Latching & Magnetic-Latching

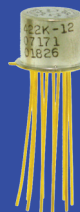

COMMERCIAL RELAYS

- Standard electrical tests at 25 °C
- "Low cost" switching solutions
- Surface-Mount
- Short lead times

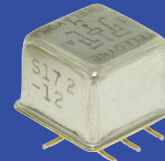

Teledyne Relays offers Commercial/Industrial Solid State Relays?

SINGLE PHASE AC SOLID STATE RELAYS

- Up to 690Vac, 125A
- Input & Output Protection
- Chassis, DIN Rail and PCB Mount
- Zero-Cross & Random Switching
- Touch-Proof Covers



DUAL-PHASE AC SOLID STATE RELAYS

- Up to 600Vac, 50A
- Output Protection
- Chassis and DIN Rail
- Zero-Cross & Random Switching
- Touch-Proof Covers



3 & 4 PHASE SOLID STATE RELAYS

- Up to 600Vac, 75A
- Output Protection
- Chassis and DIN Rail
- Zero-Cross & Random Switching
- DC & AC Control

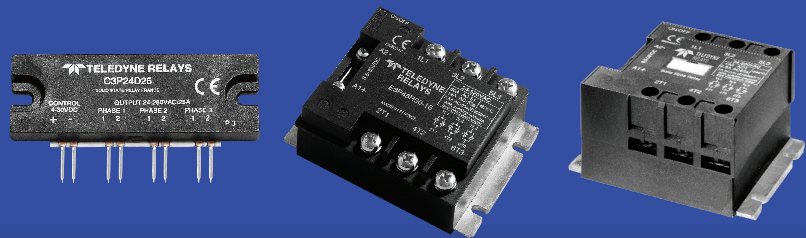

DC SOLID STATE RELAYS

- Up to 1400Vdc, 100A
- Output Protection
- Chassis, DIN Rail and PCB Mount
- IGBT and MOSFET
- Touch-Proof Covers



SOFT START MOTOR CONTROLLERS AND MOTOR REVERSERS

- Up to 26kW, 480Vac
- Star & Delta Configurations
- DIN Rail
- Output Protection
- Built-in Diagnostics and Self Test

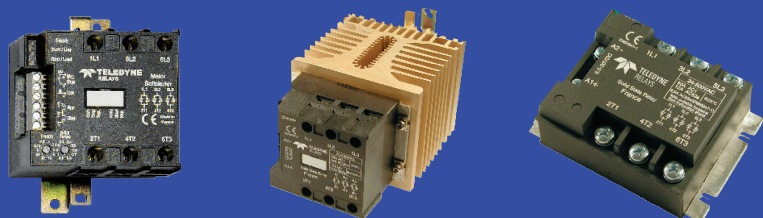

Did you know...

Teledyne Relays offers Military Solid State Relays?

DC SOLID STATE RELAYS

- Meet MIL-PRF-28750
- Tested Per MIL-STD-704
- Silicon Carbide MOSFET
- Up to 250Vdc, 1A
- Chassis and PCB Mount
- Short-Circuit Protection
- Plastic and Hermetically Sealed



BI-DIRECTIONAL/AC SOLID STATE RELAYS

- Meet MIL-PRF-28750
- Tested Per MIL-STD-704
- Up to 250Vac, 25A
- Chassis and PCB Mount
- Short-Circuit Protection
- Plastic and Hermetically Sealed

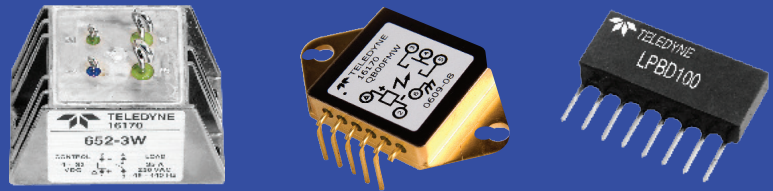

COMMERCIAL, LOW POWER, I/O MODULES

- Up to 250Vac, 10A
- Short-Circuit Protection
- Chassis and PCB Mount
- Zero-Cross & Random Switching
- Low Off-State Leakage Current

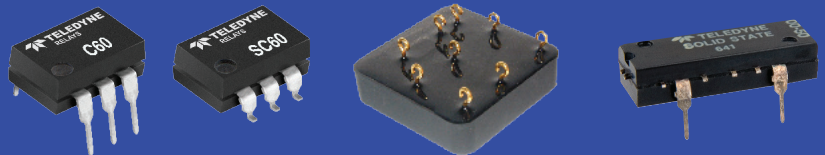

SILICON CARBIDE TECHNOLOGY

- Up to 270Vdc, 20 A
- Meet MIL-PRF-28750
- Tested Per MIL-STD-704
- Low ON resistance
- Low Profile Hermetic Package
- Options: Trip Status, Switch Status
- Short Circuit Protection

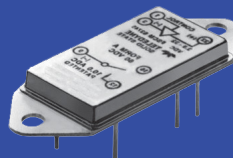

Did you know...

Teledyne Coax Switches offers coaxial switch matrices for ATE, Radar, Filter Switching, Airborne Surveillance Systems, Etc.?

MINI MATRICES

- Remote Control via USB and/or Ethernet
- GUI controllable
- Accepts ASCII code
- Available in 18, 26.5 and 40 GHz
- SPDT, Transfer and Multi-throw configurations

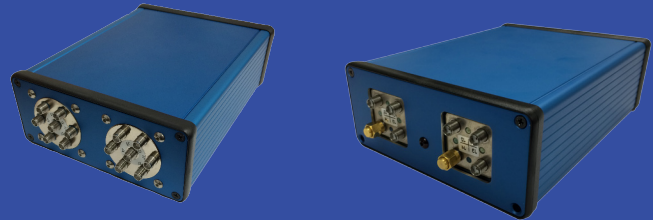

MULTIPLEXOR/FANOUT SWITCH MATRICES

- Up to 1x1024 Switch Matrix
- SMA, mini-SMB, TNC & N Connectors
- Failsafe, Latching or Normally Open Configurations
- Switching Systems for 50 Ω & 75 Ω applications

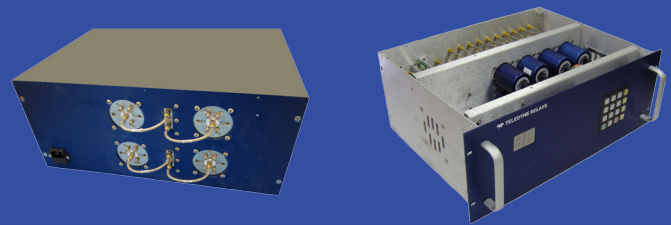

MIMO/BLOCKING AND MIMO SINGLE CONNECTION SWITCH MATRICES

- Up to 1x1024 Switch Matrix
- SMA, mini-SMB, TNC & N Connectors
- RS-232, TTL, USB, GPIB, TTL, Ethernet Control
- 1 Million Cycles
- Failsafe & Latching

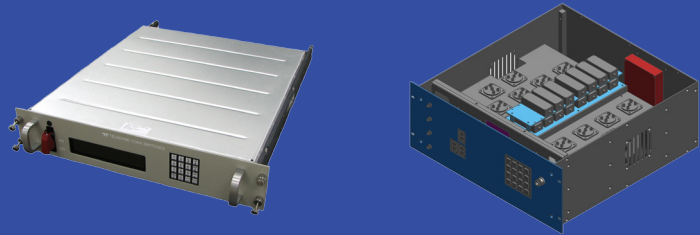

CUSTOMIZED SWITCH MATRICES

- EMI/RFI
- Transient Suppression
- Ballistic Shock Fatigue
- Crash Load
- Altitude



Did you know...

Teledyne Relays offers Space Qualified Switches?

SPACE MARKET SEGMENTS SERVED

- Deep-Space Probes
- Manned Programs
- Communications Satellites
- Launch Vehicles
- Earth Observatory / Weather Satellites
- Commercial / Military Satellites

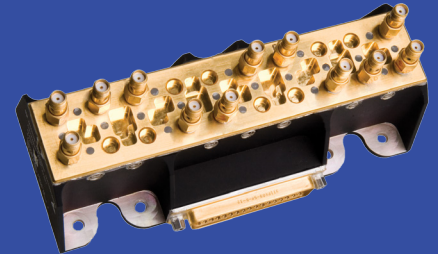

CAPABILITIES

- Logistic Infrastructure
- Chemical Analysis Lab
- Scanning Electro Microscope
- In-house Plating Shop
- Environment Test Lab
- Field Technical Support

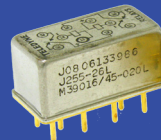

ELECTROMECHANICAL RELAY SPECIFICATIONS

- MIL-PRF-39016
- MIL-PRF-28776
- NASA/GSFC S-311-P-754
- NASA EEE-INST-002
- ESA/SCC 3601 & 3602

